

POWER SYSTEMS

AESFULAP[®] BURRS & BLADES

CATALOG 2021

AESCULAP® BURRS & BLADES

POWER SYSTEMS



CONTENT – INHALT – SOMMAIRE – ÍNDICE – INDICE

› SAGITTAL SAW BLADES (OSCILLATING SAW BLADES)	5 – 20
Sagittale Sägeblätter (oszillierende Sägeblätter) – Lames de scie sagittale (lames oscillantes) – Hojas de sierra sagitales (hojas de sierra oscilantes) – Lame per sega sagittale (lame per sega oscillante)	
› RECIPROCATING SAW BLADES	21 – 30
Stichsägeblätter – Lames de scie alternative – Hojas de sierra de punta – Lame per sega reciprocant	
› TRANSVERSAL SAW BLADES	31 – 38
Transversalsägeblätter – Lames de scie transversale – Hojas de sierra transversal – Lame per sega trasversale	
› ELAN 4 BURRS	39 – 50
ELAN 4 Fräser – Fraises ELAN 4 – Fresa ELAN 4 – Fresa ELAN 4	
› Hi-Line XS BURRS	51 – 56
Hi-Line XS Fräser – Fraises Hi-Line XS – Fresa Hi-Line XS – Fresa Hi-Line XS	
› Hi-Line BURRS	57 – 60
Hi-Line Fräser – Fraises Hi-Line – Fresa Hi-Line – Fresa Hi-Line	
› 2.35 mm BURRS	61 – 66
2,35 mm Fräser – Fraises 2,35 mm – Fresa 2,35 mm – Fresa 2,35 mm	
› TWIST DRILLS, INTRAMEDULLARY REAMERS	67 – 70
Spiralbohrer, Markraumborher – Forets hélicoïdaux, foret intramédullaire – Broca helicoidal, broca para cavidad medular – Perforatore spiralato, perforatore midollare	
› SKULL PERFORATORS, CRANIOTOME BURRS	71 – 72
Schädeltrepane, Kraniotomfräser – Trépans crâniens, fraises de craniotome – Trépanos y fresas para craneótomo – Perforatori cranici, frese per craniotomia	
› OTHERS	73 – 76
Sonstige – Divers – Otros – Altro	
› INDEX, UNIVERSAL TOOL ATTACHMENTS, SIGNS AND SYMBOLS	77 – 84
Index, Universelle Werkzeuganschlüsse, Zeichenerklärung – Sommaire, Raccords d'outil universels, Explication des symboles – Índice, Conexiones universales para útiles, Explicación de los símbolos – Indice, Attacchi utensili universali, Spiegazione dei simboli	

All measurements and technical data listed in this brochure are approximate as they are subject to normal manufacturing tolerances and to technical modifications.

Alle Maße und technischen Daten in diesem Katalog sind Nennmaße, welche anerkannten fertigungsbedingten Toleranzen unterliegen und sind vorbehaltlich technischer Änderungen.

Toutes les dimensions et données techniques figurant dans ce catalogue sont des valeurs nominales soumises à des tolérances de fabrication reconnues et fournies sous réserve de modifications techniques.

Todas las medidas y datos técnicos de este catálogo son medidas nominales que están sujetas a tolerancias de fabricación reconocidas y, por tanto, a modificaciones técnicas.

Tutte le misurazioni e le specifiche tecniche contenute in questo catalogo sono solo nominali in quanto soggette alle normali tolleranze di fabbricazione e a eventuali modifiche tecniche.

AESCULAP® BURRS & BLADES

SAGITTAL SAW BLADES (OSCILLATING SAW BLADES)

Sagittale Sägeblätter (oszillierende Sägeblätter)

Lames de scie sagittale (lames oscillantes)

Hojas de sierra sagitales (hojas de sierra oscilantes)

Lame per sega sagittale (lame per sega oscillante)



GA836/GA736

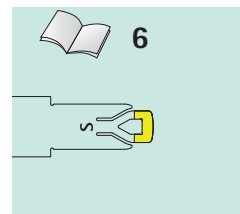

GA831/GA731

GB891R

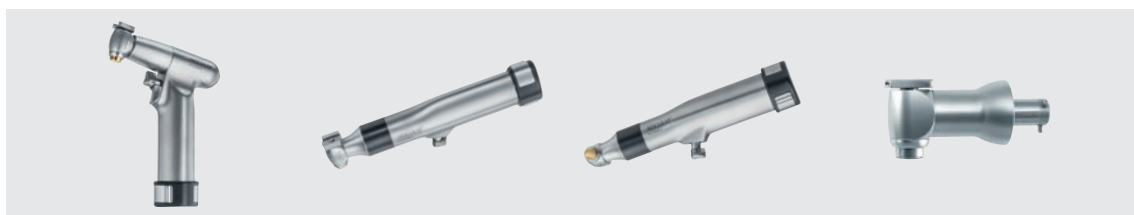
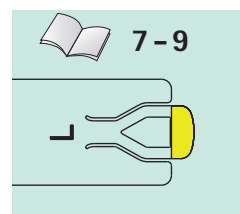

GA331

GA336

GA337

GB660R

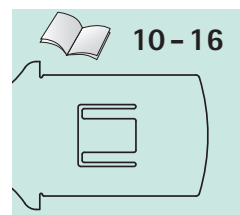

GD307

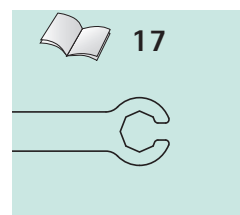

GB390R

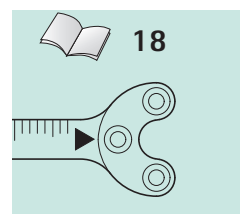

GB129

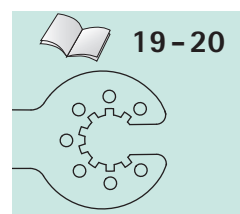

AESCULAP® BURRS & BLADES





SAGITTAL SAW BLADES (OSCILLATING SAW BLADES)

Sagittale Sägeblätter (oszillierende Sägeblätter)

Lames de scie sagittale (lames oscillantes)

Hojas de sierra sagitales (hojas de sierra oscilantes)

Lame per sega sagittale (lame per sega oscillante)

	 sterile					
GP491R		14 mm	13 mm	0.3 mm	0.3 mm	» GA736, GA836
GP492R		15 mm	5 mm	0.3 mm	0.3 mm	
GP493R		20 mm	5 mm	0.3 mm	0.3 mm	
GP494R		20 mm	10 mm	0.3 mm	0.3 mm	
GP495R		20 mm	15 mm	0.3 mm	0.3 mm	
GP496R		25 mm	5 mm	0.3 mm	0.3 mm	
GP497R		25 mm	12 mm	0.3 mm	0.3 mm	

GP491R

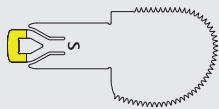

GP496R



GP492R



GP497R

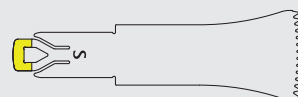

GP493R



GP494R

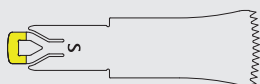

GP495R

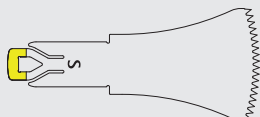



1 sterile



GP501R	15 mm	5 mm	0.5 mm	0.5 mm
GP502R	15 mm	10 mm	0.5 mm	0.5 mm
GP504R	20 mm	5 mm	0.5 mm	0.5 mm
GP505R	20 mm	10 mm	0.5 mm	0.5 mm
GP514R	25 mm	5 mm	0.5 mm	0.7 mm
GP515R	25 mm	10 mm	0.5 mm	0.7 mm
GP516R	25 mm	15 mm	0.5 mm	0.7 mm
GP518R	35 mm	10 mm	0.5 mm	0.5 mm
GP521R	35 mm	5 mm	0.5 mm	0.5 mm
GP522R	35 mm	10 mm	0.5 mm	0.7 mm
GP523R	35 mm	15 mm	0.5 mm	0.7 mm
GP524R	35 mm	20 mm	0.5 mm	0.7 mm

» GA731, GA831, GB891R



GP501R

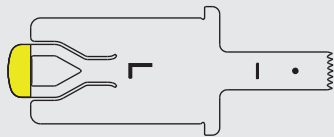

GP516R



GP502R

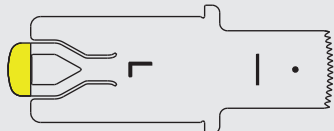

GP518R



GP504R

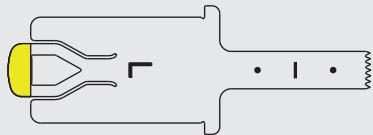

GP521R

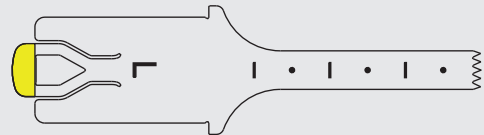

GP505R

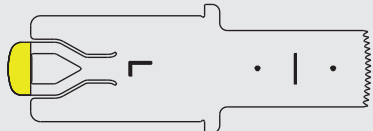

GP522R

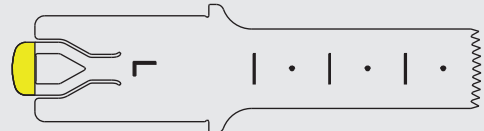

GP514R

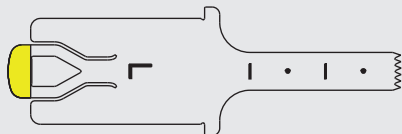

GP523R



GP515R

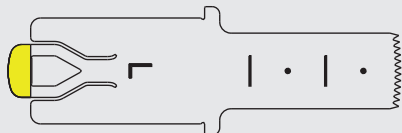

GP524R

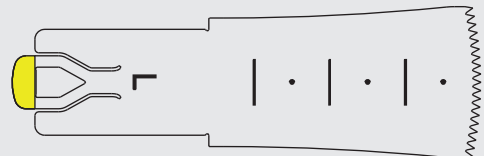

AESCULAP® BURRS & BLADES

SAGITTAL SAW BLADES (OSCILLATING SAW BLADES)

Sagittale Sägeblätter (oszillierende Sägeblätter)

Lames de scie sagittale (lames oscillantes)

Hojas de sierra sagitales (hojas de sierra oscilantes)

Lame per sega sagittale (lame per sega oscillante)



GP535R	50 mm	10 mm	0.5 mm	0.8 mm
GP536R	50 mm	15 mm	0.5 mm	0.8 mm
GP537R	50 mm	20 mm	0.7 mm	0.9 mm
GP538R	50 mm	25 mm	0.7 mm	0.9 mm
GP539R	50 mm	30 mm	0.7 mm	0.9 mm

» GA731, GA831, GB891R



GP535R

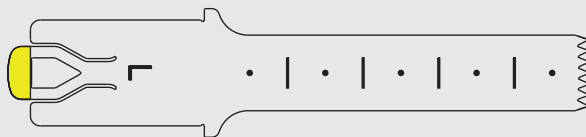

GP536R



GP537R

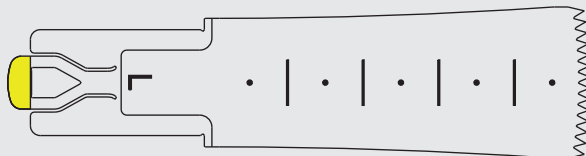

GP538R

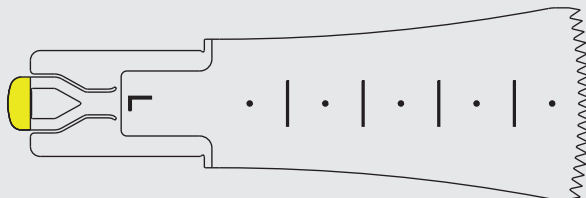

GP539R

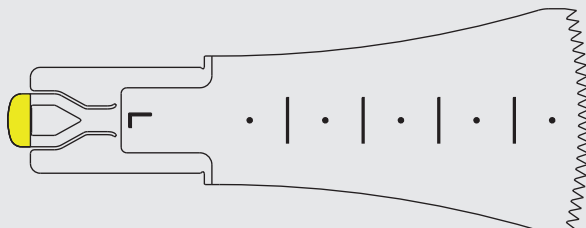



1 sterile



GP511R

35 mm

10 mm

0.5 mm

0.5 mm

10 mm

» GA731, GA831, GB891R



GP511R

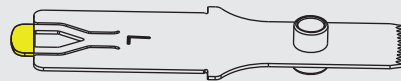
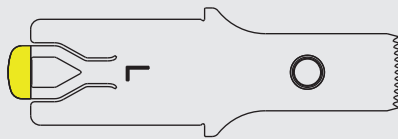

1 sterile



GP526R

51 mm

15 mm

0.5 mm

6 mm

20 mm

» GA731, GA831

GP527R

51 mm

15 mm

0.5 mm

7 mm

20 mm

GP528R

51 mm

15 mm

0.5 mm

8 mm

20 mm

GP529R

51 mm

15 mm

0.5 mm

9 mm

20 mm

GP530R

51 mm

15 mm

0.5 mm

10 mm

20 mm

GP531R

51 mm

15 mm

0.5 mm

11 mm

20 mm

GP532R

51 mm

15 mm

0.5 mm

12 mm

20 mm



GP526R -
GP532R

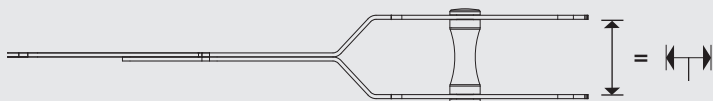
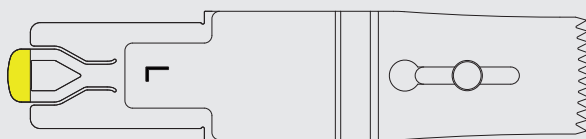

AESCU LAP[®] BURRS & BLADES







SAGITTAL SAW BLADES (OSCILLATING SAW BLADES)



Sagittale Sägeblätter (oszillierende Sägeblätter)

Lames de scie sagittale (lames oscillantes)

Hojas de sierra sagitales (hojas de sierra oscilantes)

Lame per sega sagittale (lame per sega oscillante)

	 sterile							
GC203R		25 mm	10 mm	0.5 mm	0.5 mm	10 mm	» GA331, GA336 GA673, GA668	» GB660R
GC207R		25 mm	5 mm	0.5 mm	0.5 mm			
GC208R		25 mm	15 mm	0.5 mm	0.5 mm			
GC209R		35 mm	10 mm	0.5 mm	0.8 mm			
GC211R		35 mm	20 mm	0.5 mm	0.8 mm			



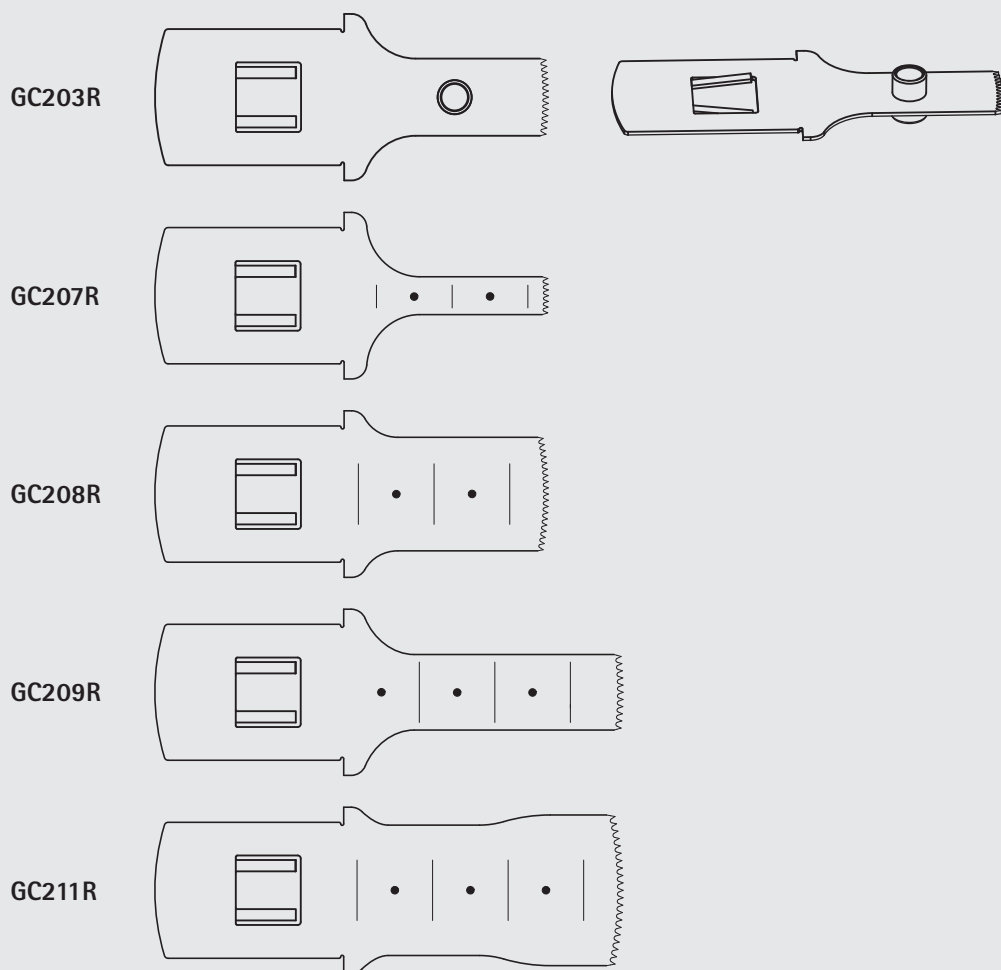

1 sterile



GC215R	50 mm	10 mm	0.5 mm	0.8 mm
GC216R	50 mm	15 mm	0.5 mm	0.8 mm
GC217R	50 mm	20 mm	0.7 mm	0.9 mm
GC218R	50 mm	25 mm	0.7 mm	0.9 mm
GC219R	50 mm	30 mm	0.7 mm	0.9 mm

» GA331, GA336
GA673, GA668

» GB660R

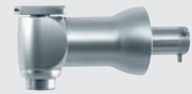

GC215R

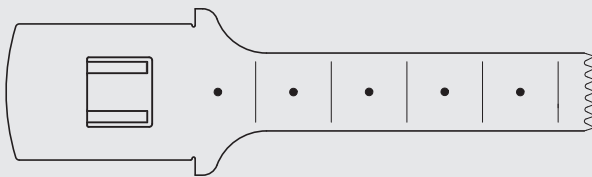

GC216R

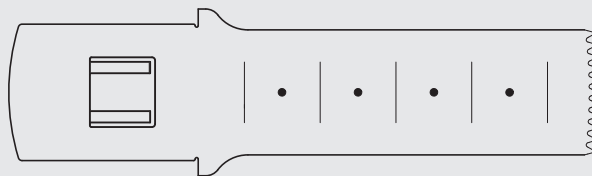

GC217R

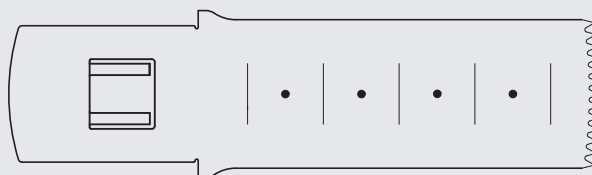

GC218R

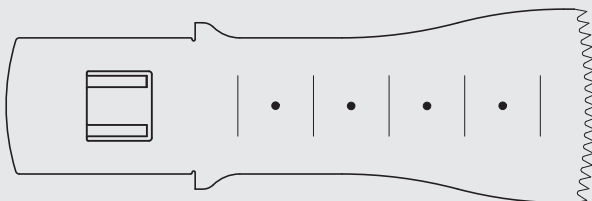

GC219R

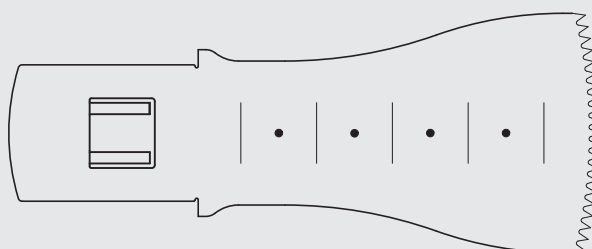

AESCULAP® BURRS & BLADES

SAGITTAL SAW BLADES (OSCILLATING SAW BLADES)

Sagittale Sägeblätter (oszillierende Sägeblätter)

Lames de scie sagittale (lames oscillantes)

Hojas de sierra sagitales (hojas de sierra oscilantes)

Lame per sega sagittale (lame per sega oscillante)



GE231SU	75 mm	9.0 mm	1.27 mm		» GA331, GA336, GA673, GA668
GE232SU	90 mm	13.5 mm	1.47 mm		
GE233SU	90 mm	13.5 mm	1.27 mm		
GE234SU	90 mm	13.0 mm	0.89 mm		
GE235SU	90 mm	13.0 mm	1.00 mm		
GE236SU	90 mm	13.0 mm	1.27 mm		
GE238SU	90 mm	19.0 mm	0.89 mm		
GE239SU	90 mm	19.0 mm	1.00 mm		
GE240SU	90 mm	19.0 mm	1.19 mm		
GE241SU	90 mm	19.0 mm	1.27 mm		
GE242SU	90 mm	19.0 mm	1.37 mm		



GE231SU

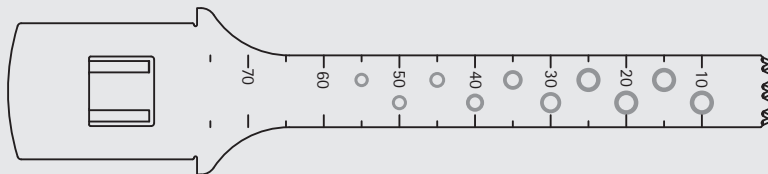

GE232SU -
GE233SU

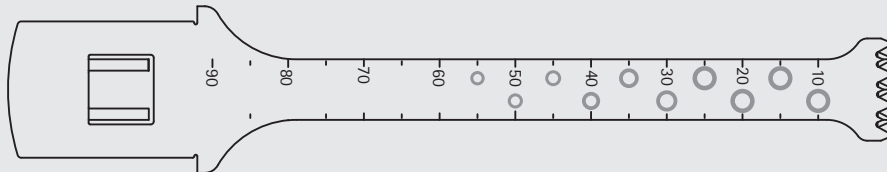

GE234SU -
GE236SU

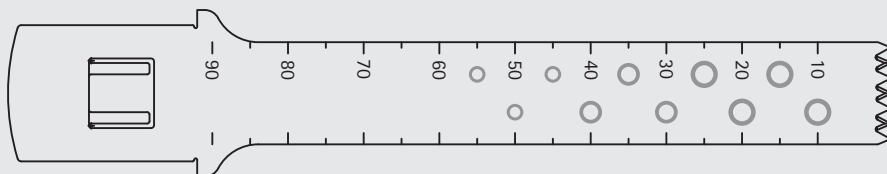

GE238SU -
GE242SU

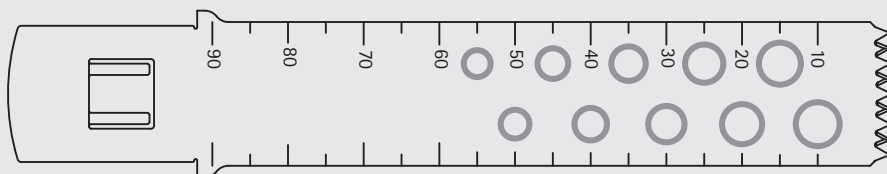



GE243SU	90 mm	23 mm	0.89 mm			» GA331, GA336, GA673, GA668 
GE244SU	90 mm	23 mm	1.00 mm			
GE245SU	90 mm	23 mm	1.19 mm			
GE246SU	90 mm	23 mm	1.27 mm			
GE247SU	90 mm	23 mm	1.37 mm			
GE248SU	90 mm	23 mm	1.47 mm			
GE249SU	100 mm	19 mm	1.27 mm			

**GE243SU -
GE248SU**

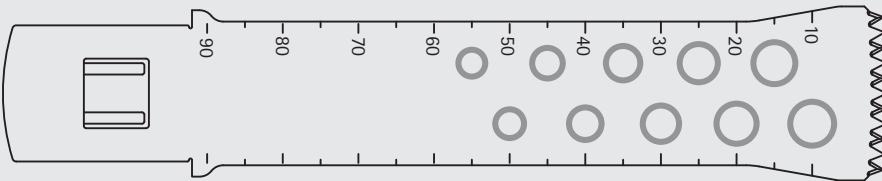

GE249SU

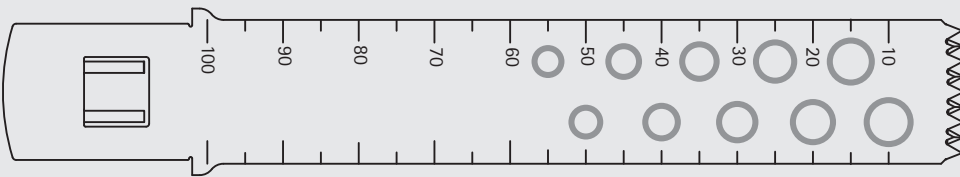

AESCU LAP[®] BURRS & BLADES

SAGITTAL SAW BLADES (OSCILLATING SAW BLADES)

Sagittale Sägeblätter (oszillierende Sägeblätter)

Lames de scie sagittale (lames oscillantes)

Hojas de sierra sagitales (hojas de sierra oscilantes)

Lame per sega sagittale (lame per sega oscillante)



GE252R	65 mm	20 mm	0.9 mm
GE253R	65 mm	26 mm	0.9 mm
GE254R	65 mm	32 mm	0.9 mm
GE255R	65 mm	41 mm	0.9 mm

» GA331, GA336, GA673, GA668

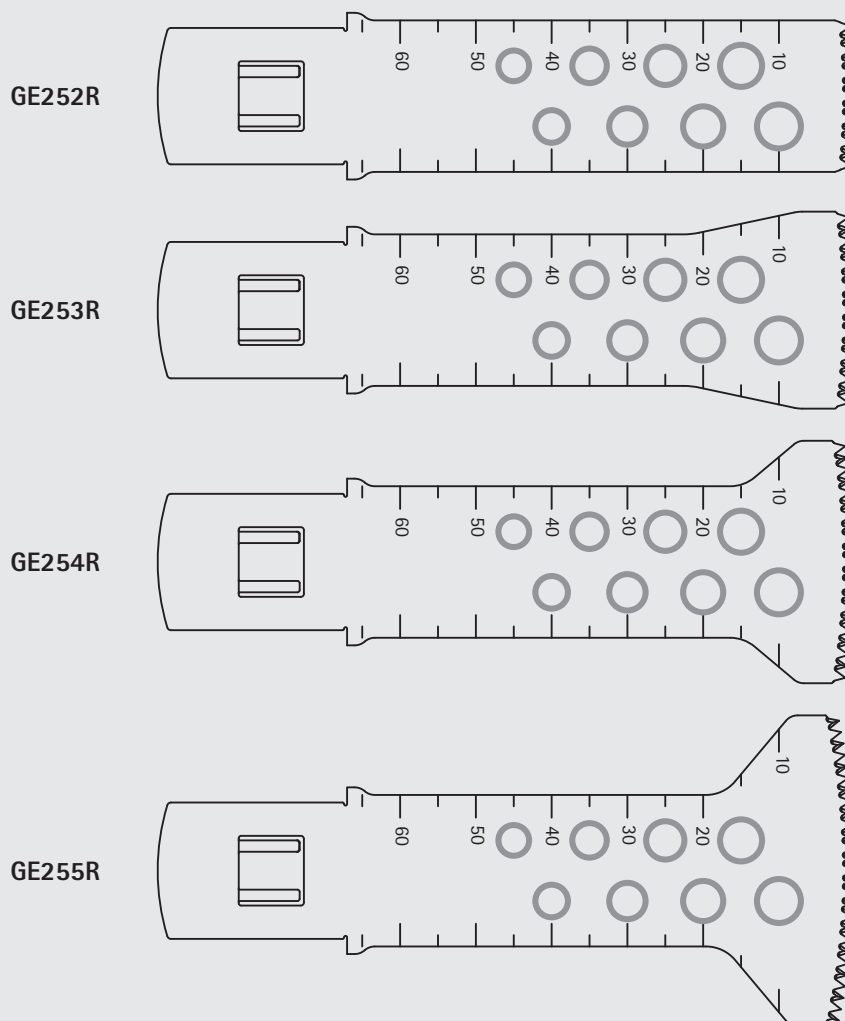



1 sterile



GC211R	35 mm	20 mm	0.5 mm	0.8 mm
GC675R	50 mm	40 mm	0.7 mm	0.9 mm
GC681R	35 mm	75 mm	0.7 mm	0.9 mm

» GA331, GA336
GA673, GA668

» GB660R



GC211R

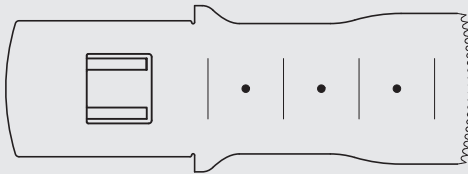

GC675R

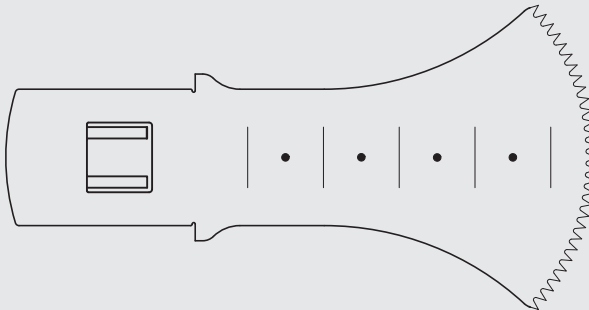

GC681R

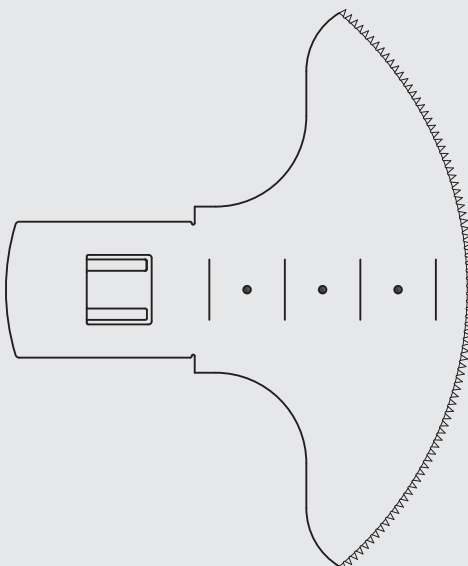

AESCULAP® BURRS & BLADES

SAGITTAL SAW BLADES (OSCILLATING SAW BLADES)

Sagittale Sägeblätter (oszillierende Sägeblätter)

Lames de scie sagittale (lames oscillantes)

Hojas de sierra sagitales (hojas de sierra oscilantes)

Lame per sega sagittale (lame per sega oscillante)



GC682R	35 mm	75 mm	0.7 mm	0.9 mm	» GA336, GA337, GA668
GC683R	50 mm	17 mm	0.7 mm	0.9 mm	

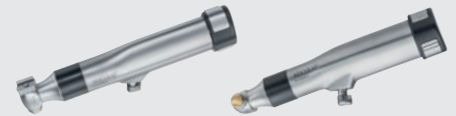

GC682R

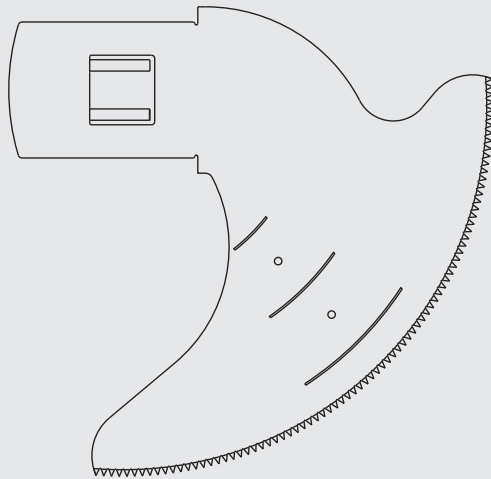

GC683R

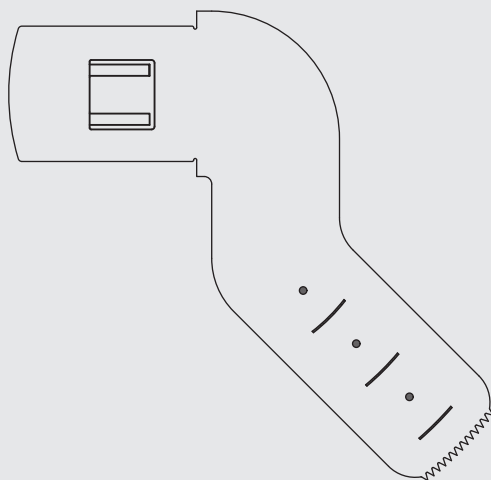



5 sterile



GD390R	10 mm	13.0 mm	0.3 mm	0.3 mm
GD391R	9 mm	13.0 mm	0.3 mm	0.3 mm
GD392R	15 mm	5.0 mm	0.3 mm	0.3 mm
GD393R	20 mm	5.0 mm	0.3 mm	0.3 mm
GD394R	20 mm	12.0 mm	0.3 mm	0.3 mm
GD395R	20 mm	15.0 mm	0.3 mm	0.3 mm
GD396R	25 mm	5.0 mm	0.3 mm	0.3 mm
GD397R	25 mm	12.0 mm	0.3 mm	0.3 mm

» GD307



GD390R

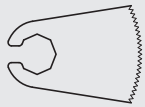

GD395R

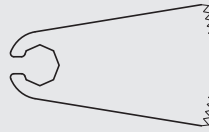

GD391R

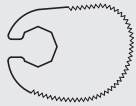

GD396R

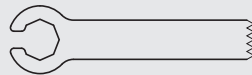

GD392R



GD397R



GD393R

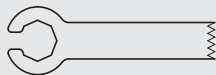

GD394R

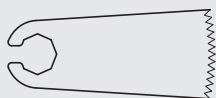

AESCULAP® BURRS & BLADES







SAGITTAL SAW BLADES (OSCILLATING SAW BLADES)

Sagittale Sägeblätter (oszillierende Sägeblätter)

Lames de scie sagittale (lames oscillantes)

Hojas de sierra sagitales (hojas de sierra oscilantes)

Lame per sega sagittale (lame per sega oscillante)

	 sterile					
GC114R		15 mm	5 mm	0.35 mm	0.5 mm	»GB390R 
GC115R		15 mm	10 mm	0.35 mm	0.5 mm	
GC124R		20 mm	5 mm	0.35 mm	0.5 mm	
GC125R		20 mm	10 mm	0.35 mm	0.5 mm	
GC127R		20 mm	5 mm	0.50 mm	0.7 mm	
GC128R		20 mm	10 mm	0.50 mm	0.7 mm	
GC137R		25 mm	5 mm	0.50 mm	0.7 mm	
GC138R		25 mm	10 mm	0.50 mm	0.7 mm	
GC139R		25 mm	15 mm	0.50 mm	0.7 mm	
GC148R		35 mm	10 mm	0.50 mm	0.7 mm	
GC149R		35 mm	15 mm	0.50 mm	0.7 mm	

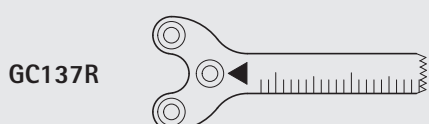
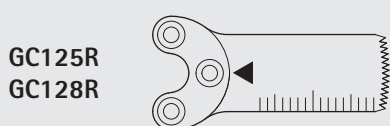
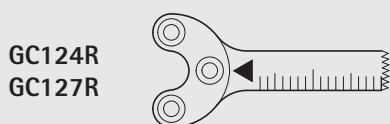
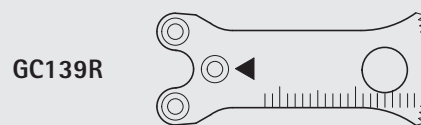
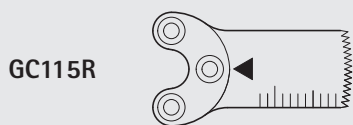
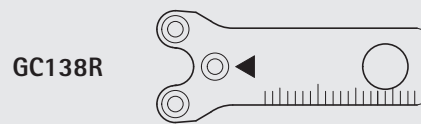
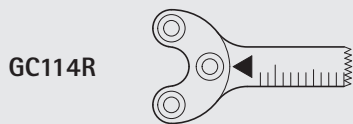



GC604R	25 mm	5 mm	0.5 mm	0.5 mm	
GC605R	25 mm	10 mm	0.5 mm	0.5 mm	
GC634R	35 mm	5 mm	0.5 mm	0.5 mm	
GC635R	35 mm	10 mm	0.5 mm	0.8 mm	
GC636R	35 mm	20 mm	0.5 mm	0.8 mm	

» **GB129**

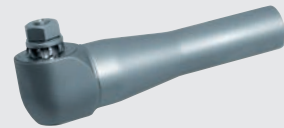

GC604R

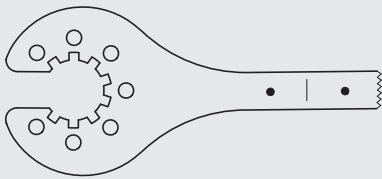

GC605R

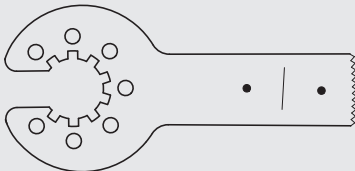

GC634R

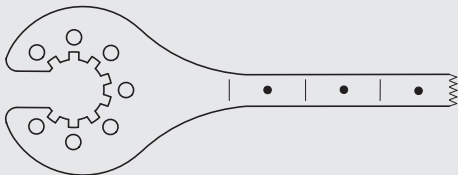

GC635R

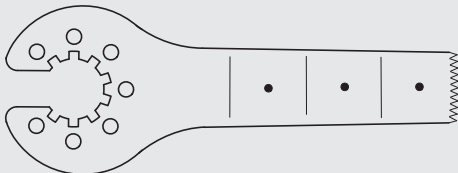

GC636R

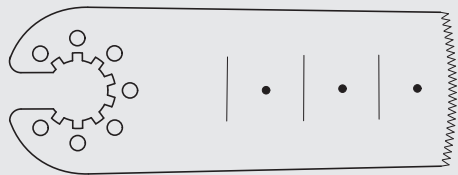

AESCULAP® BURRS & BLADES

SAGITTAL SAW BLADES (OSCILLATING SAW BLADES)

Sagittale Sägeblätter (oszillierende Sägeblätter)

Lames de scie sagittale (lames oscillantes)

Hojas de sierra sagitales (hojas de sierra oscilantes)

Lame per sega sagittale (lame per sega oscillante)



GC648R	50 mm	10 mm	0.5 mm	0.8 mm	»GB129
GC649R	50 mm	15 mm	0.5 mm	0.8 mm	
GC650R	50 mm	20 mm	0.7 mm	0.9 mm	
GC651R	50 mm	25 mm	0.7 mm	0.9 mm	
GC652R	50 mm	30 mm	0.7 mm	0.9 mm	



GC648R

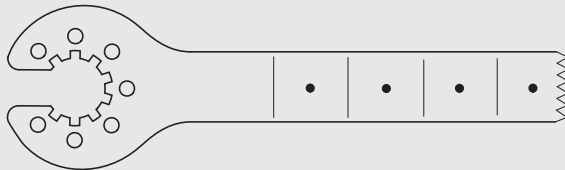

GC649R

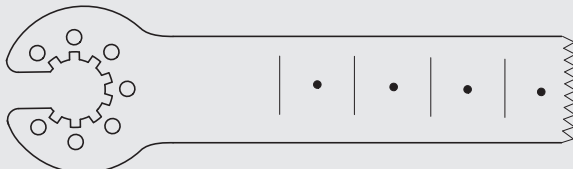

GC650R

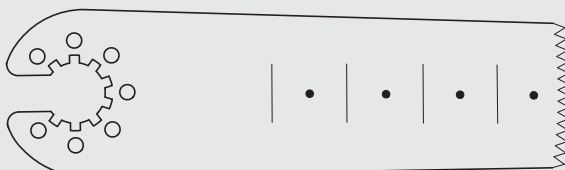

GC651R

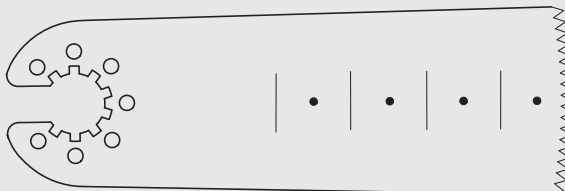

GC652R

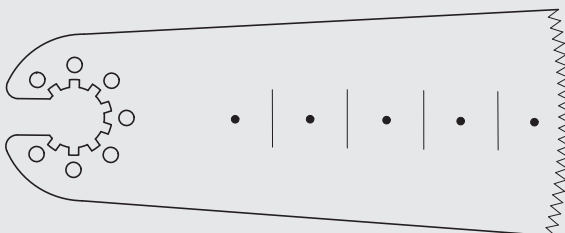

RECIPROCATING SAW BLADES

Stichsägeblätter

Lames de scie alternative

Hojas de sierra de punta

Lame per sega recipocant



GA837/GA737

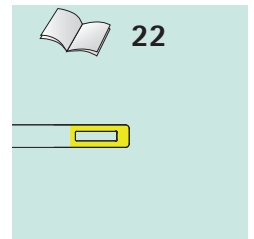

GA832/GA732

GB892R

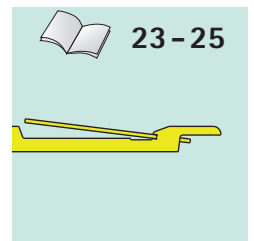

GA334

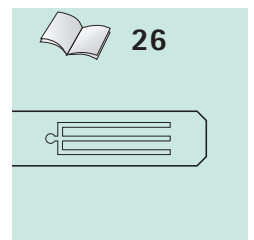

GD305

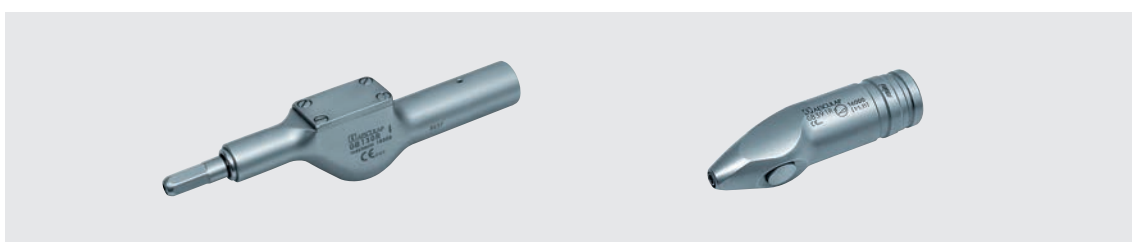
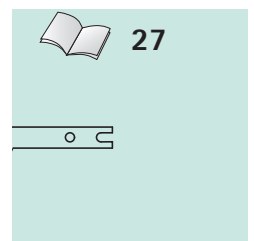

GB130R

GB391R

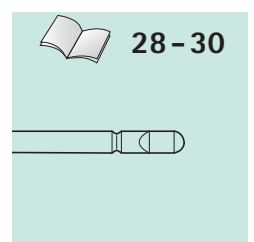

AESCULAP® BURRS & BLADES

RECIPROCATING SAW BLADES

Stichsägeblätter

Lames de scie alternative

Hojas de sierra de punta

Lame per sega reciprocant



GP541R	16 mm	0.3 mm	0.3 mm	<p>» GA737, GA837</p> 
GP542R	13 mm	0.3 mm	0.3 mm	
GP543R	20 mm	0.3 mm	0.3 mm	
GP544R	13 mm	0.3 mm	0.3 mm	
GP545R	20 mm	0.3 mm	0.3 mm	

GP541R

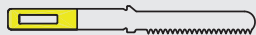

GP542R

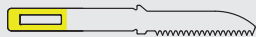

GP543R



GP544R



GP545R





1 sterile



GP551R	84 mm	25 mm	0.40 mm	0.60 mm
GP561R	104 mm	25 mm	0.40 mm	0.60 mm
GP552R	85 mm	27 mm	0.25 mm	0.35 mm
GP553R	85 mm	27 mm	0.40 mm	0.60 mm
GP562R	105 mm	27 mm	0.25 mm	0.35 mm
GP563R	105 mm	27 mm	0.40 mm	0.60 mm
GP554R	91 mm	33 mm	0.40 mm	0.60 mm
GP564R	111 mm	33 mm	0.40 mm	0.60 mm

» GA732, GA832, GB892R



GP551R

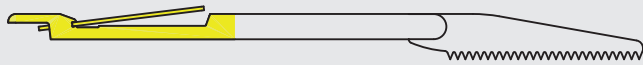

GP561R

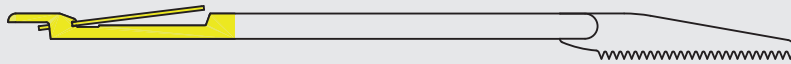

GP552R

GP553R

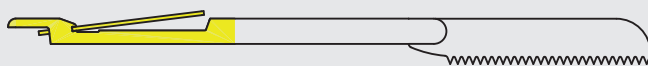

GP562R

GP563R

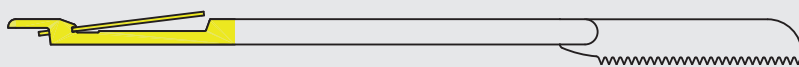

GP554R

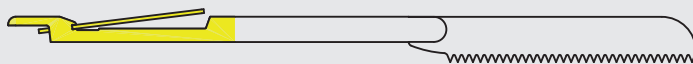

GP564R

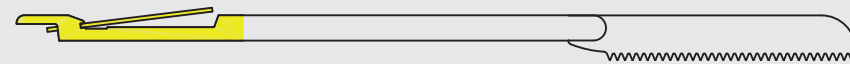

AESCULAP® BURRS & BLADES





RECIPROCATING SAW BLADES

Stichsägeblätter

Lames de scie alternative

Hojas de sierra de punta

Lame per sega reciprocant

						
GP565R		115 mm	37 mm	0.4 mm	0.6 mm	
GP550R		73 mm	15 mm	0.4 mm	0.6 mm	
GP575R		79 mm	17 mm	0.4 mm	0.6 mm	4 mm
GP576R		86 mm	24 mm	0.4 mm	0.6 mm	6 mm
						
GC615R		23 mm	0.25 mm	0.35 mm		
GC633R		23 mm	0.25 mm	0.35 mm		
						
GP559R		70 mm				
GP569R		90 mm				

» GA732, GA832, GB892R



GP565R

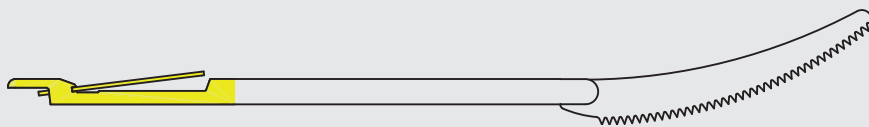

GP550R

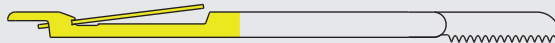

GP575R

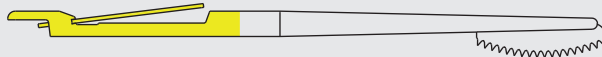

GP576R

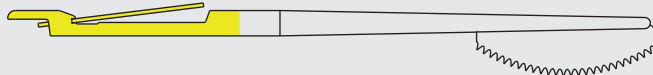

GC615R



GC633R



GP559R

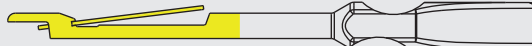

GP569R

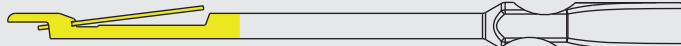

1 sterile



GP557R

75 mm

10.0 mm

5 mm

GP558R

75 mm

12.5 mm

7 mm

GP567R

93 mm

10.5 mm

5 mm

» GA732, GA832, GB892R

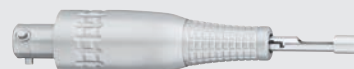

GP557R

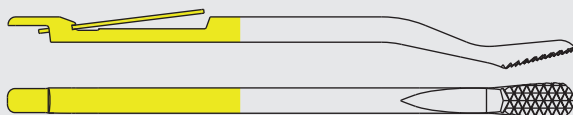

GP558R

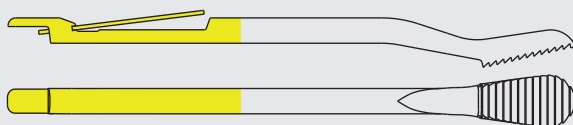

GP567R

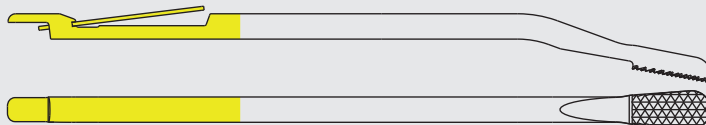

AESCULAP® BURRS & BLADES







RECIPROCATING SAW BLADES

Stichsägeblätter

Lames de scie alternative

Hojas de sierra de punta

Lame per sega reciprocant

	 sterile					
GC766R		43 mm		0.7 mm	0.9 mm	» GA334, GA674 
GC767R		60 mm		0.7 mm	0.9 mm	
GC768R		75 mm		0.7 mm	0.9 mm	
GC769R		75 mm		1.0 mm	1.2 mm	
GC770R		75 mm	12 mm	0.7 mm	0.9 mm	
GC771R		75 mm	12 mm	1.0 mm	1.2 mm	

GC766R

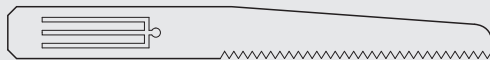

GC767R

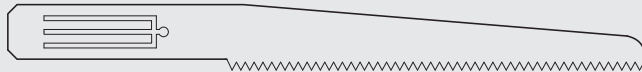

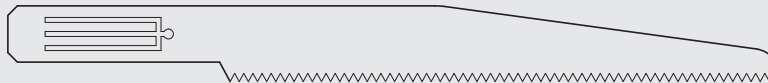

**GC768R -
GC769R**

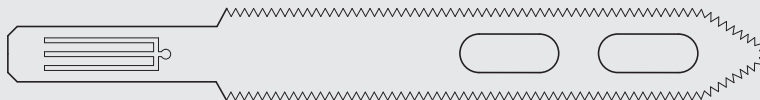

**GC770R -
GC771R**



	 sterile				
GC761R		34 mm	0.7 mm	1.1 mm	» GA334 + GB436R GA674 + GB436R 

GC761R

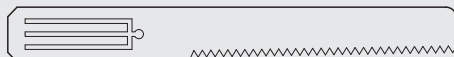



GD320R	13 mm	0.3 mm	0.3 mm			» GD305 
GD321R	20 mm	0.3 mm	0.3 mm			
GD322R	13 mm	0.3 mm	0.3 mm			
GD323R	13 mm	0.3 mm	0.3 mm			



AESCALAP[®] BURRS & BLADES







RECIPROCATING SAW BLADES

Stichsägeblätter

Lames de scie alternative

Hojas de sierra de punta

Lame per sega reciprocant

	 sterile						
GC912R		84 mm	25 mm	0.40 mm	0.60 mm		»GB130R
GC655R		104 mm	25 mm	0.40 mm	0.60 mm		»GB391R
GC906R		85 mm	27 mm	0.25 mm	0.35 mm		
GC907R		85 mm	27 mm	0.40 mm	0.60 mm		
GC657R		105 mm	27 mm	0.40 mm	0.60 mm		
GC909R		91 mm	33 mm	0.40 mm	0.60 mm		
GC658R		111 mm	33 mm	0.40 mm	0.60 mm		

GC912R



GC655R

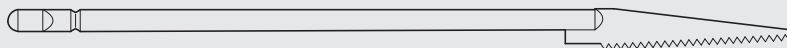

**GC906R -
GC907R**

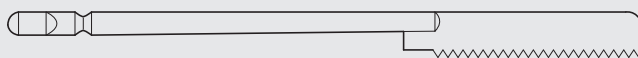

GC657R

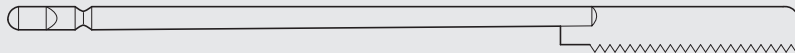

GC909R

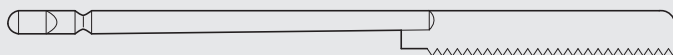

GC658R

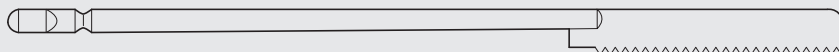



1 sterile



GC905R

73 mm

15 mm

0.4 mm

0.6 mm

» GB130R

» GB391R

10 sterile



GC615R

23 mm

0.25 mm

0.35 mm

GC633R

23 mm

0.25 mm

0.35 mm



1 sterile



GC927R

70 mm

GC654R

90 mm

GC905R

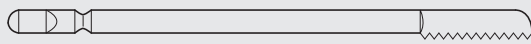

GC615R

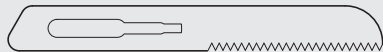

GC633R



GC927R

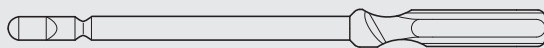

GC654R



AESCULAP® BURRS & BLADES













RECIPROCATING SAW BLADES

Stichsägeblätter

Lames de scie alternative

Hojas de sierra de punta

Lame per sega reciprocant

	 sterile							
GC915R		79 mm	17 mm	0.4 mm	0.6 mm	4 mm	»GB130R	»GB391R
GC923R		88 mm	33 mm	0.4 mm	0.6 mm			
GC925R		88 mm	33 mm	0.4 mm	0.6 mm	5 mm		
GC926R		88 mm	33 mm	0.4 mm	0.6 mm	5 mm		
	 sterile							
GC919R		75.5 mm	10 mm	5 mm				
GC921R		75.5 mm	12.5 mm	7 mm				

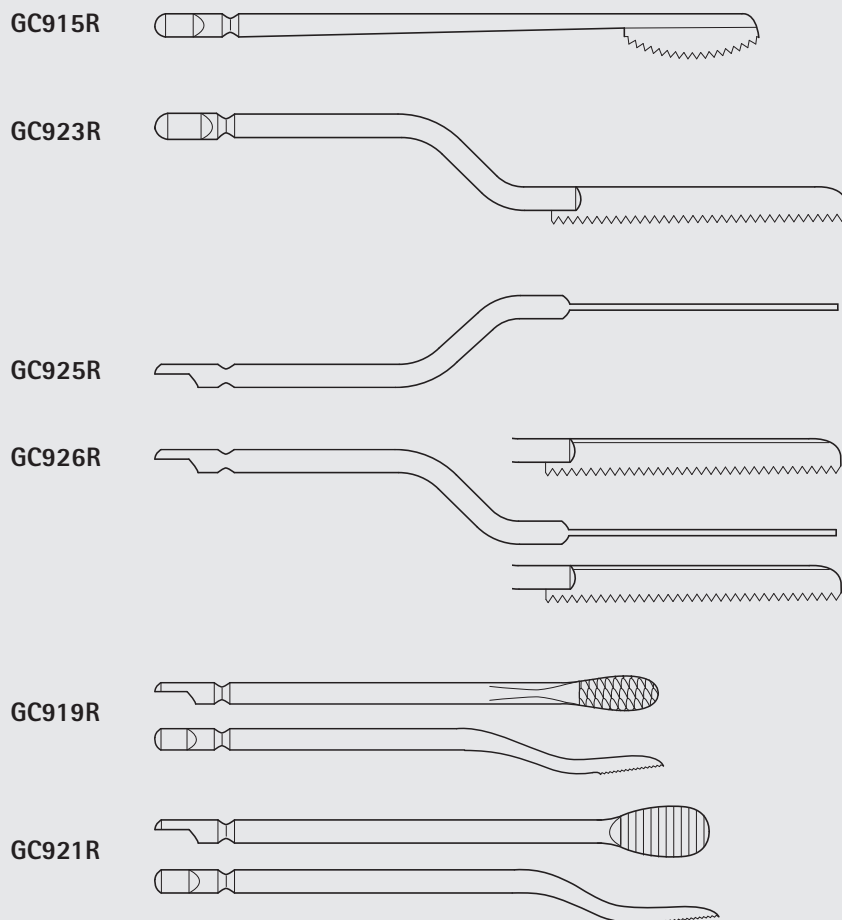

TRANSVERSAL SAW BLADES

Transversalsägeblätter
Lames de scie transversale
Hojas de sierra transversal
Lame per sega trasversale



GA833/GA733

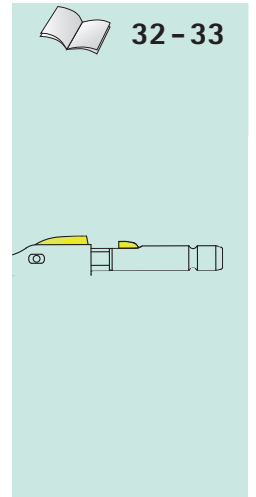

GB392R

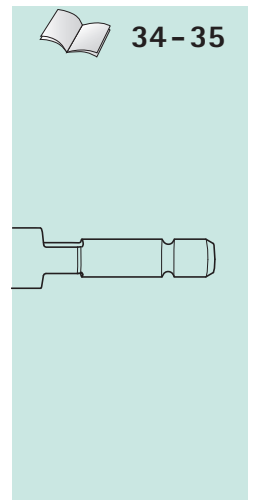

GB128R

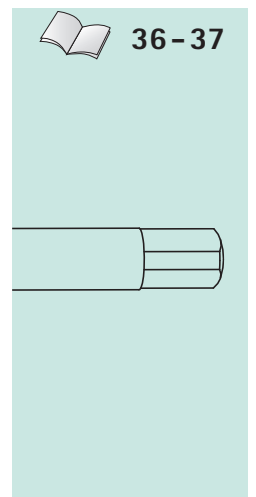

AESCULAP® BURRS & BLADES

TRANSVERSAL SAW BLADES

Transversalsägeblätter

Lames de scie transversale

Hojas de sierra transversal

Lame per sega trasversale



GP580R	65 mm	S	» GA733, GA833
GP582R	65 mm	M	
GP586R	95 mm	M	
GP590R	30 mm	L	

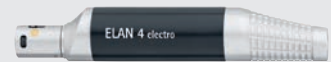

GP580R



GP582R

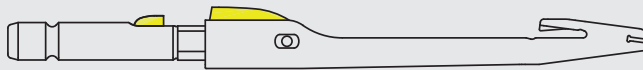

GP586R

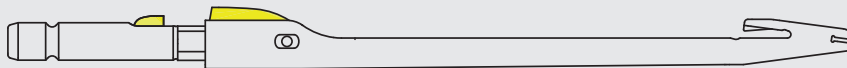

GP590R

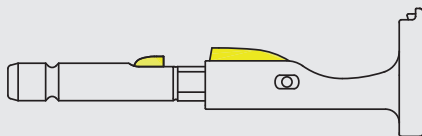

1 sterile



GP581R	8 mm	4 mm	0.3 mm	0.4 mm	S
GP583R	10 mm	10 mm	0.5 mm	0.7 mm	M
GP584R	15 mm	12 mm	0.5 mm	0.7 mm	M
GP587R	11 mm	7 mm	0.5 mm	0.7 mm	M
GP588R	11 mm	12 mm	0.5 mm	0.7 mm	M
GP591R	8 mm	25 mm	0.5 mm	0.7 mm	L
GP594R	8 mm	12 mm	0.5 mm	0.7 mm	L
GP595R	14 mm	12 mm	0.5 mm	0.7 mm	L
GP598R	37 mm	25 mm	0.5 mm	0.7 mm	L

» GA733, GA833

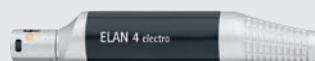

GP581R



GP583R

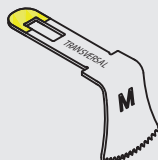

GP584R

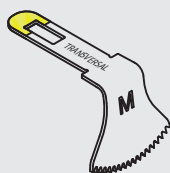

GP587R

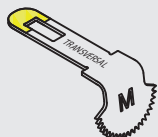

GP588R

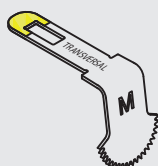

GP591R



GP594R



GP595R

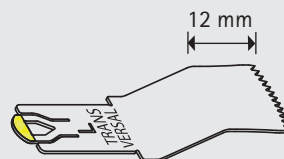

GP598R

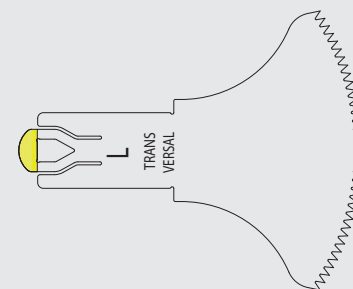

AESCALAP[®] BURRS & BLADES







TRANSVERSAL SAW BLADES

Transversalsägeblätter

Lames de scie transversale

Hojas de sierra transversal

Lame per sega trasversale

	 sterile						
GC261R		65 mm	7.5 mm	4 mm	0.3 mm	0.4 mm	 »GB392R
GC263R		60 mm	10.5 mm	8 mm	0.5 mm	0.6 mm	
GC265R		60 mm	16.0 mm	12 mm	0.5 mm	0.5 mm	
GC267R		95 mm	11.0 mm	7 mm	0.4 mm	0.6 mm	
GC269R		95 mm	11.0 mm	12 mm	0.4 mm	0.6 mm	

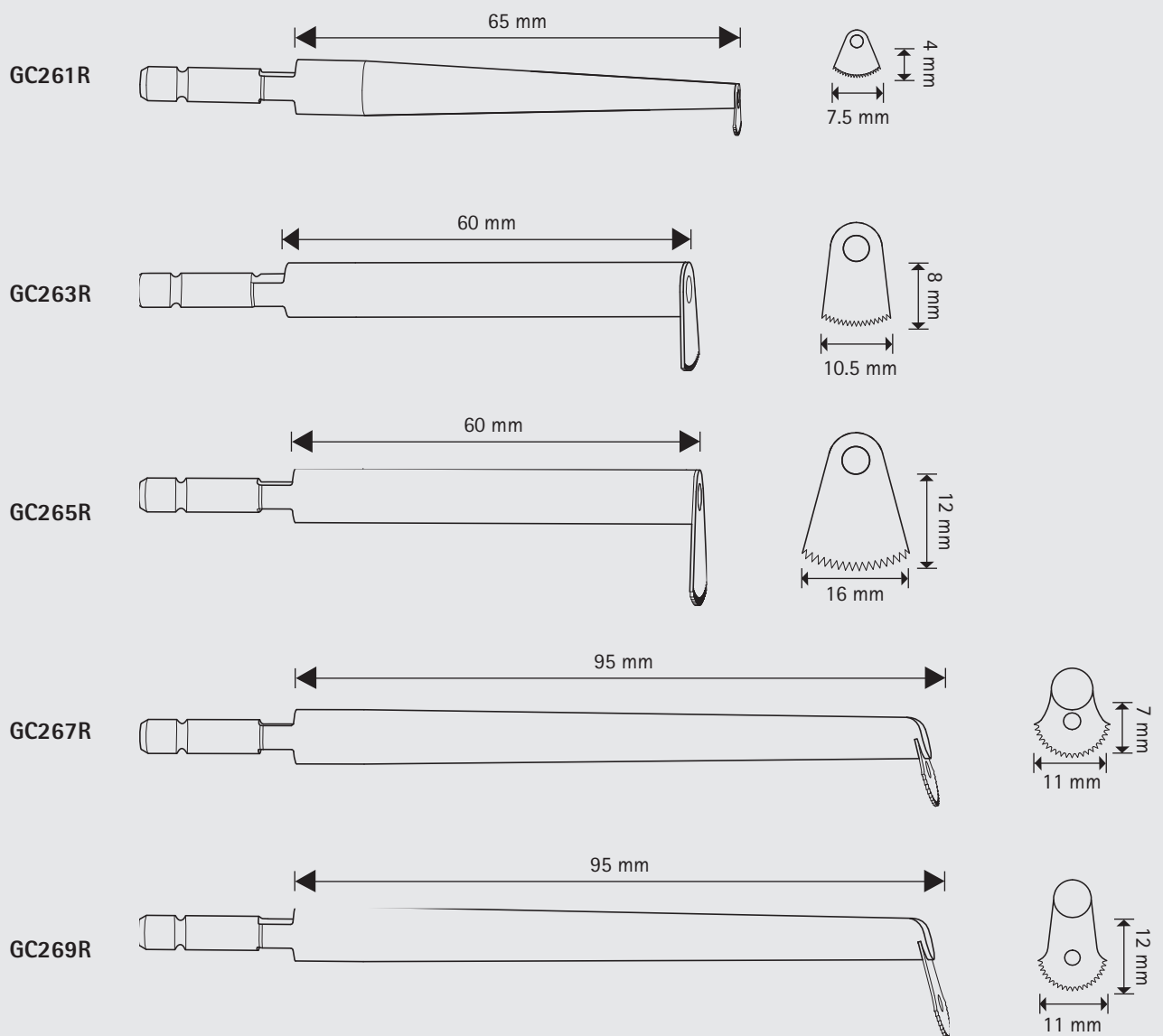

1 sterile



» GB392R



GC271R	8.0 mm	25 mm	0.5 mm	0.7 mm
GC273R	7.3 mm	30 mm	0.6 mm	0.7 mm
GC277R	8.0 mm	11 mm	0.5 mm	0.7 mm
GC279R	16.0 mm	11 mm	0.5 mm	0.7 mm

GC271R

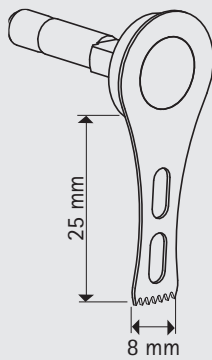

GC277R

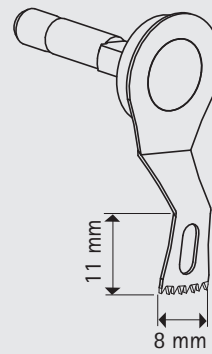

GC273R

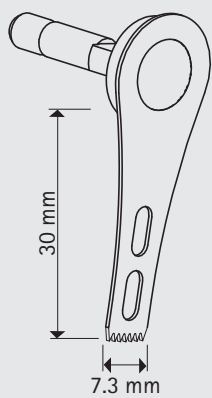

GC279R

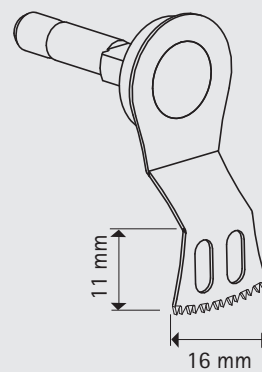

AESCULAP® BURRS & BLADES







TRANSVERSAL SAW BLADES

Transversalsägeblätter

Lames de scie transversale

Hojas de sierra transversal

Lame per sega trasversale

							
GC584R		65 mm	7.5 mm	4 mm	0.25 mm	0.4 mm	»GB128R
GC583R		60 mm	10.5 mm	8 mm	0.50 mm	0.6 mm	
GC585R		60 mm	16.0 mm	12 mm	0.50 mm	0.5 mm	
GC587R		95 mm	11.0 mm	7 mm	0.40 mm	0.6 mm	
GC586R		95 mm	11.0 mm	12 mm	0.40 mm	0.6 mm	

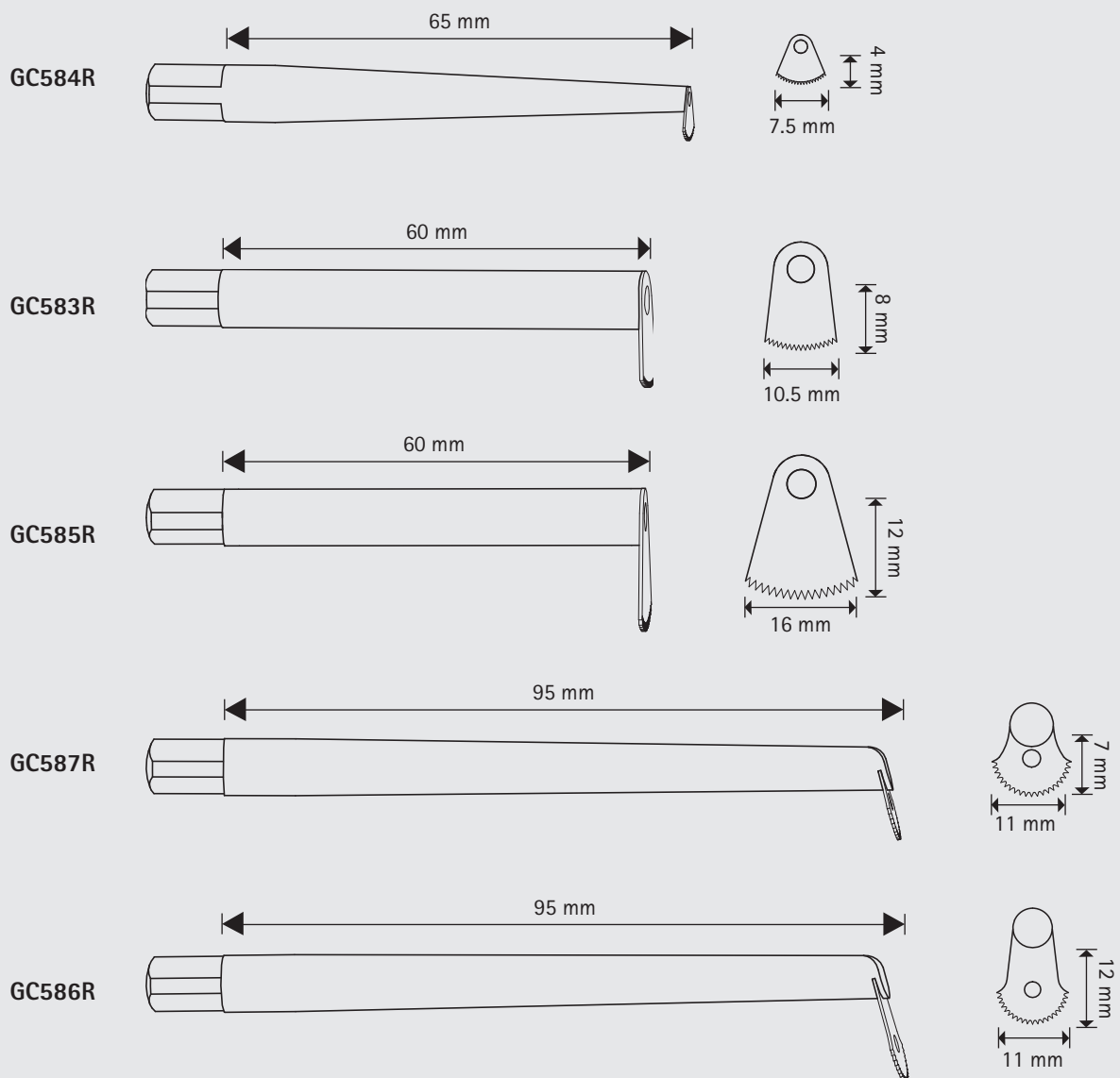



GC570R	9/40 mm	15 mm	0.5 mm	0.8 mm
GC575R	8 mm	25 mm	0.5 mm	0.7 mm
GC576R	7.3 mm	30 mm	0.6 mm	0.7 mm
GC578R	8 mm	11 mm	0.5 mm	0.7 mm
GC580R	16 mm	11 mm	0.5 mm	0.7 mm

» **GB128R**



GC570R

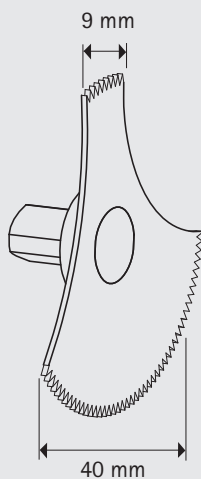

GC576R

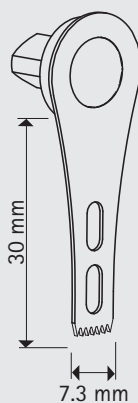

GC580R

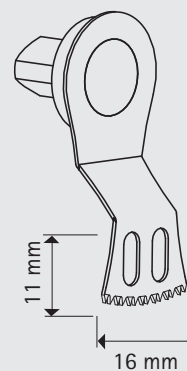

GC575R

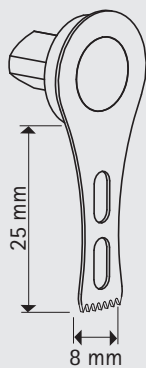

GC578R

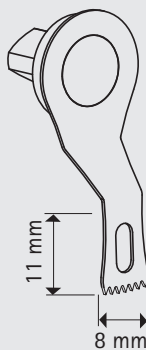

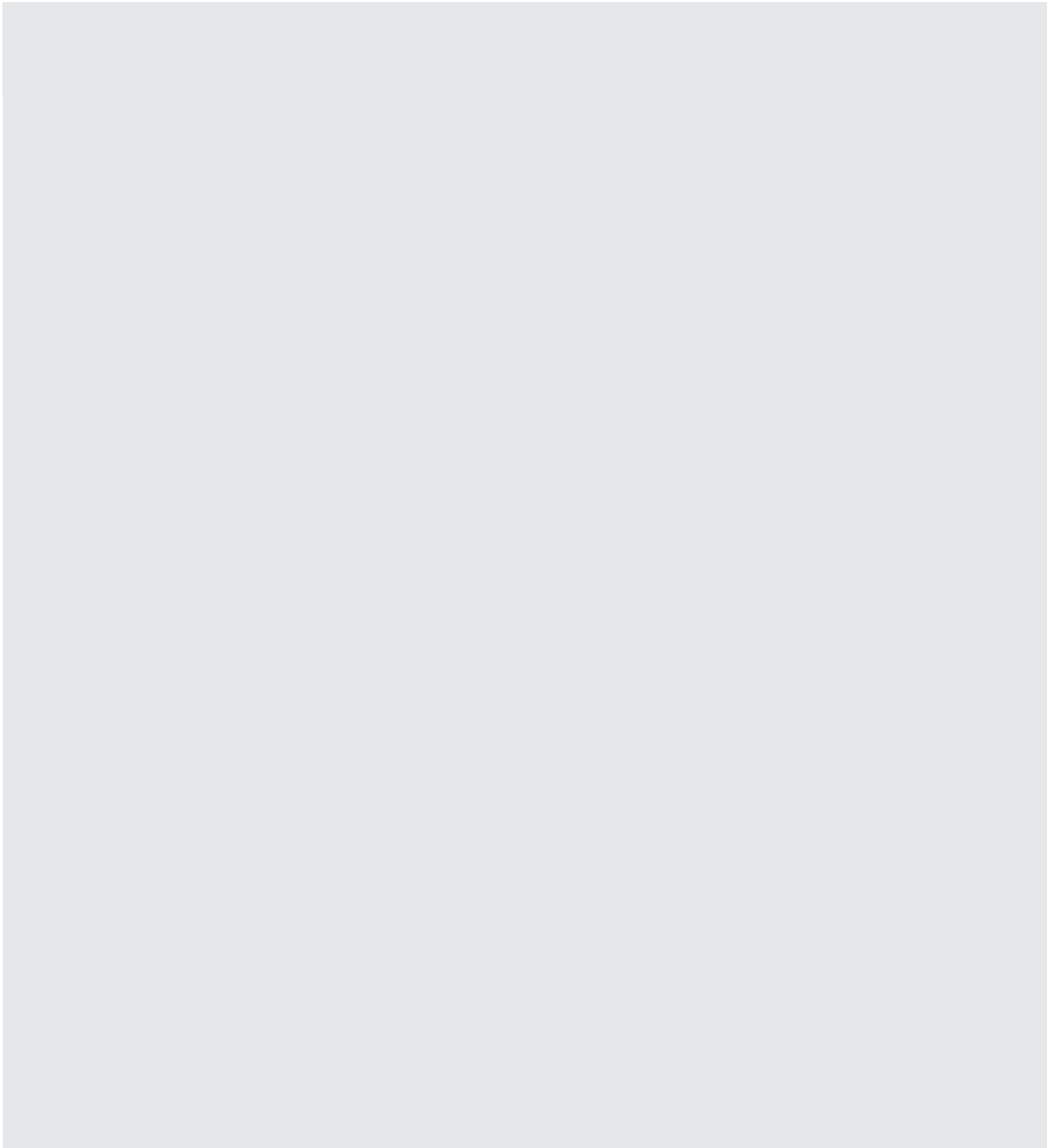

AESCULAP® BURRS & BLADES

ELAN 4 BURRS

ELAN 4 Fräser
 Fraises ELAN 4
 Fresa ELAN 4
 Fresa ELAN 4

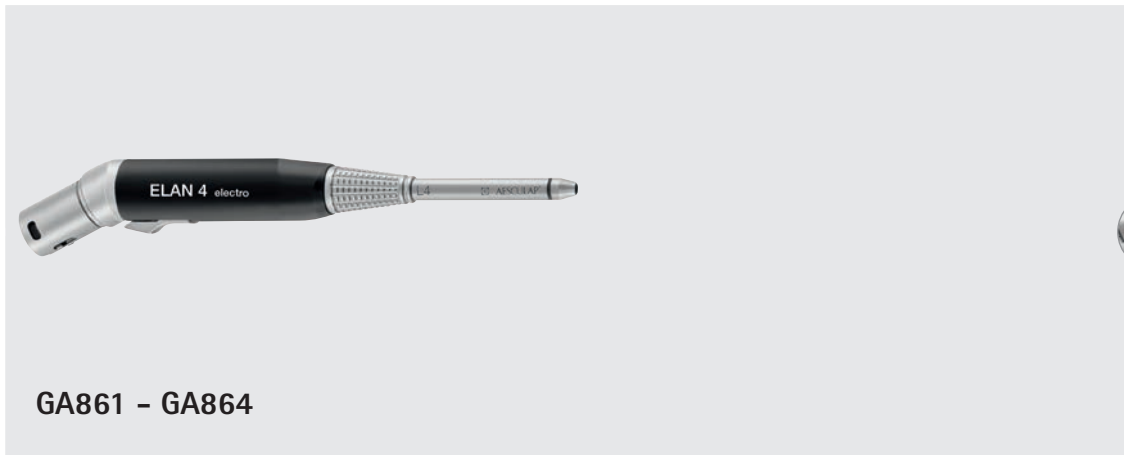

I



II

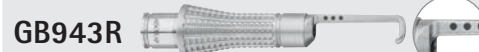

II

AESCU LAP® BURRS & BLADES













ELAN 4 BURRS – 1-RING











ELAN 4 Fräser – 1-Ring







Fraises ELAN 4 – 1 anneau





Fresa ELAN 4 – 1 anillos

Fresa ELAN 4 – 1 anelli







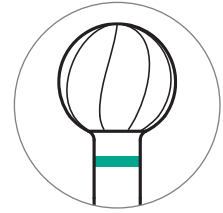

Ø	0.6 mm	0.8 mm	1.0 mm	1.0 mm	1.4 mm	1.4 mm	1.8 mm	1.8 mm	2.3 mm	2.3 mm		
												sterile
I	GP111R	GP112R	GP113R	GP114R	GP115R	GP116R	GP117R	GP118R	GP120R	GP121R		Rosen

Ø	2.7 mm	2.7 mm	3.0 mm	3.5 mm	4.0 mm	4.5 mm	5.0 mm	6.0 mm				
												sterile
I	GP122R	GP123R	GP124R	GP125R	GP126R	GP127R	GP128R	GP129R				Rosen

Ø	3.0 mm	4.0 mm	5.0 mm	6.0 mm	
Soft cut					
					
I	GP133R	GP134R	GP135R	GP136R	Rosen





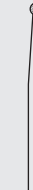
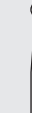
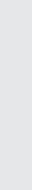



Ø	4.0 mm	5.0 mm	6.0 mm	7.0 mm	
					
I	GP184R	GP185R	GP186R	GP187R	Twin-Cut burr Twin-Cut Fräser Fraise Twin-Cut Fresa Twin-Cut Fresa Twin-Cut



Ø	0.6 mm	0.8 mm	1.0 mm	1.0 mm	1.4 mm	1.4 mm	1.8 mm	1.8 mm	2.3 mm	2.3 mm		
												
I	GP141R	GP142R	GP143R	GP144R	GP145R	GP146R	GP147R	GP148R	GP149R	GP150R		

 sterile

Diamond burr
 Diamantfräser
 Fraise à diamant
 Fresa diamante
 Fresa a diamante

Ø	2.7 mm	2.7 mm	3.0 mm	3.5 mm	4.0 mm	4.5 mm	5.0 mm	6.0 mm				
												
I	GP151R	GP152R	GP153R	GP154R	GP155R	GP156R	GP157R	GP158R				

 sterile

Diamond burr
 Diamantfräser
 Fraise à diamant
 Fresa diamante
 Fresa a diamante

ELAN 4



AESULAP[®] BURRS & BLADES











ELAN 4 BURRS – 1-RING







ELAN 4 Fräser – 1-Ring

Fraises ELAN 4 – 1 anneau

Fresa ELAN 4 – 1 anillos

Fresa ELAN 4 – 1 anelli

Ø	2.0 mm	2.0 mm	2.3 mm	2.3 mm	3.0 mm	3.0 mm	4.0 mm	5.0 mm	6.0 mm			
												
I	GP161R	GP162R	GP163R	GP164R	GP165R	GP166R	GP168R	GP169R	GP170R			
												 sterile Diamond burr coarse, Diamantfräser grob, Fraise diamantée rugueuse, Fresa diamantada de grano grueso, Frese a diamante grosse

Ø	3.0 mm	4.0 mm	5.0 mm	6.0 mm	7.0 mm							
												
I	GP173R	GP174R	GP175R	GP176R	GP177R							
												 sterile Diamond burr extra coarse, Diamantfräser extra grob, Fraise diamantée très rugueuse, Fresa diamantada de grano extra grueso, Frese a diamante extra-grosse

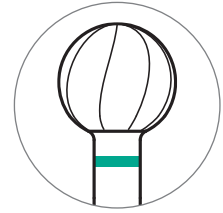

Ø	1.5 mm	2.0 mm	2.5 mm	3.0 mm	3.0 mm
US Type					
I	GP201R	GP202R	GP203R	GP204R	GP205R

sterile

Neuro cutter
Olivenfräser
Fraise à olive
Fresa oliva
Fresa ad oliva

Ø	2.0 mm	2.5 mm	3.0 mm
AESCLAP® Type			
I	GP208R	GP209R	GP210R

sterile

Neuro cutter
Olivenfräser
Fraise à olive
Fresa oliva
Fresa ad oliva

Ø	1.5 mm	1.5 mm	2.0 mm	2.0 mm	2.5 mm	2.5 mm	3.0 mm	3.0 mm	4.0 mm	4.0 mm
I	GP211R	GP212R	GP213R	GP214R	GP215R	GP216R	GP217R	GP218R	GP219R	GP220R

sterile

Neuro cutter diamond
Olivenfräser diamantiert
Fraise à olive diamantée
Fresa oliva diamantada
Fresa ad oliva diamant

Ø	4.0 mm	5.0 mm	6.0 mm
Standard			
I	GP224R	GP225R	GP226R

sterile

Barrel burr
Walzenfräser
Fraise cylindrique
Fresa cilíndrica
Fresa tangenziale

Ø	4.0 mm	5.0 mm	6.0 mm
Soft cut			
I	GP228R	GP229R	GP230R

sterile

Barrel burr
Walzenfräser
Fraise cylindrique
Fresa cilíndrica
Fresa tangenziale

Ø	4.0 mm	5.0 mm	6.0 mm
I	GP234R	GP235R	GP236R

sterile

Cone burr
Kegelfräser
Fraise conique
Fresa cónica
Fresa conica



AESCULAP® BURRS & BLADES

ELAN 4 BURRS – 1-RING

ELAN 4 Fräser – 1-Ring

Fraises ELAN 4 – 1 anneau

Fresa ELAN 4 – 1 anillos

Fresa ELAN 4 – 1 anelli

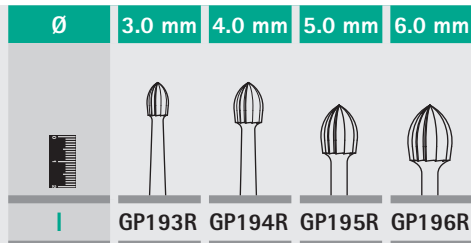
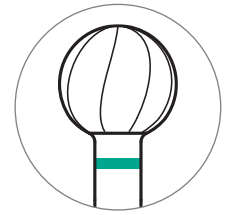

Acorn burr
Flammenfräser
Fraise flamme
Fresa flama
Fresa di flamma

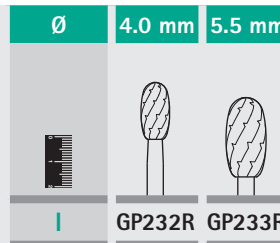

Oval burr
Ellipsenfräser
Fraise elliptique
Fresa elíptica
Fresa elíptica

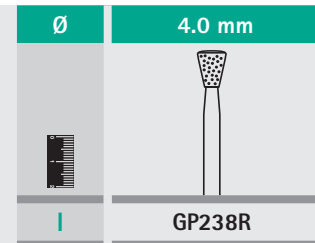

Reverse taper burr coarse diamond
Osteophytenfräser
Fraise pour ostéophytes
Fresa per resezione osteofiti
Fresa de diamante para osteofitos

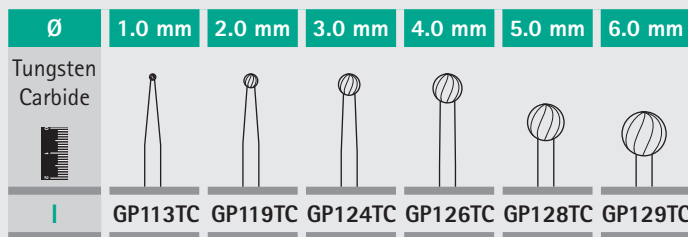

Rosen

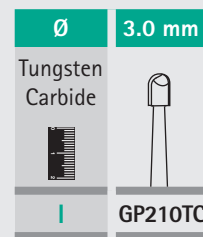

Neuro cutter
Olivenfräser
Fraise à olive
Fresa oliva
Fresa ad oliva

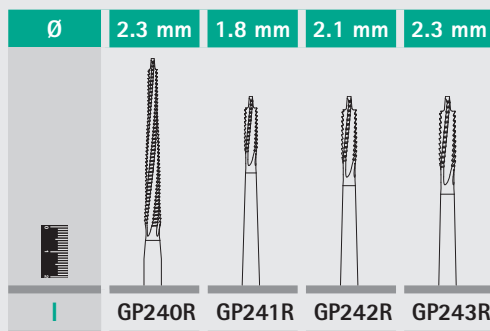

Lindemann

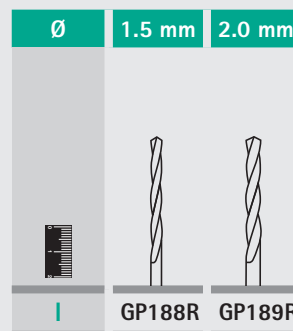

Twist drill
Spiralbohrer
Fraise spirale
Broca espiral
Punta elicoidale

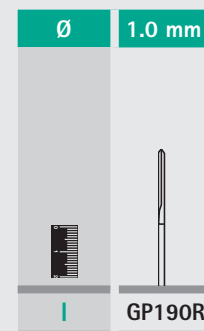

Pin cutter
Pinfräser
Fraise pointue
Fresa punta
Fresa puntuale

ELAN 4 BURRS – 2-RING

ELAN 4 Fräser – 2-Ring
 Fraises ELAN 4 – 2 anneaux
 Fresa ELAN 4 – 2 anillos
 Fresa ELAN 4 – 2 anelli

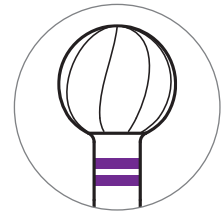

Ø	2.3 mm	3.0 mm	3.5 mm	4.0 mm	4.5 mm	5.0 mm	6.0 mm	7.0 mm	8.0 mm			
II	GP301R	GP302R	GP303R	GP304R	GP305R	GP306R	GP307R	GP308R	GP309R			1 sterile Rosen

Ø	2.3 mm	3.0 mm	3.5 mm	4.0 mm	4.5 mm	5.0 mm	6.0 mm					
II	GP311R	GP312R	GP313R	GP314R	GP315R	GP316R	GP317R					1 sterile Diamond burr Diamantfräser Fraise à diamant Fresa diamante Fresa a diamante

Ø	2.3 mm	3.0 mm	4.0 mm	5.0 mm	6.0 mm							
II	GP321R	GP322R	GP323R	GP324R	GP325R							1 sterile Diamond burr coarse, Diamantfräser grob, Fraise diamantée rugueuse, Fresa diamantada de grano grueso, Frese a diamante grosse

Ø	4.0 mm	5.0 mm	6.0 mm									
II	GP328R	GP329R	GP330R									1 sterile Diamond burr extra coarse, Diamantfräser extra grob, Fraise dia- mantée très rugueuse, Fresa diamantada de grano extra grueso, Frese a diamante extra-grosse

ELAN 4

AESCULAP® BURRS & BLADES

ELAN 4 BURRS – 2-RING

ELAN 4 Fräser – 2-Ring

Fraises ELAN 4 – 2 anneaux

Fresa ELAN 4 – 2 anillos

Fresa ELAN 4 – 2 anelli

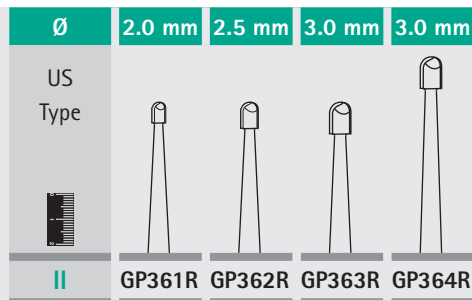

Neuro cutter
Olivenfräser
Fraise à olive
Fresa oliva
Fresa ad oliva

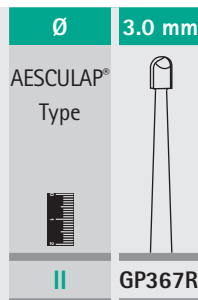

Neuro cutter
Olivenfräser
Fraise à olive
Fresa oliva
Fresa ad oliva

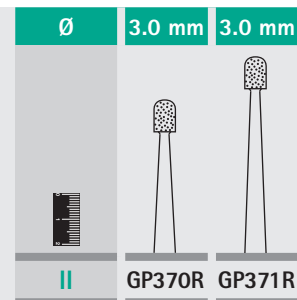

Neuro cutter diamond
Olivenfräser diamantiert
Fraise à olive diamantée
Fresa oliva diamantada
Fresa ad oliva diamant

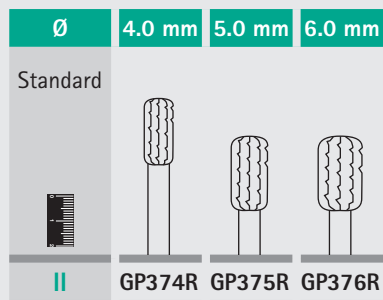

Barrel burr
Walzenfräser
Fraise cylindrique
Fresa cilíndrica
Fresa tangenziale

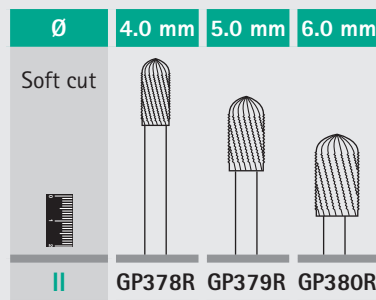

Barrel burr
Walzenfräser
Fraise cylindrique
Fresa cilíndrica
Fresa tangenziale

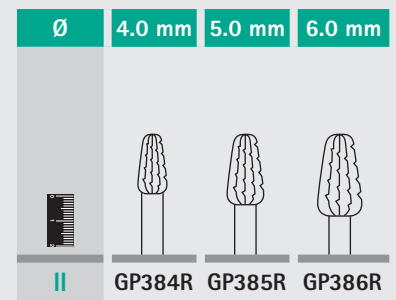

Cone burr
Kegelfräser
Fraise conique
Fresa cónica
Fresa conica

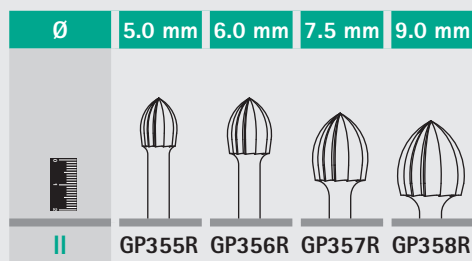

Acorn burr
Flammenfräser
Fraise flamme
Fresa flama
Fresa di flamma

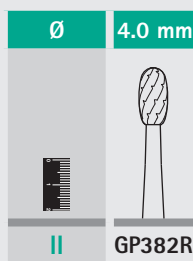

Oval burr
Ellipsenfräser
Fraise elliptique
Fresa elíptica
Fresa elíptica

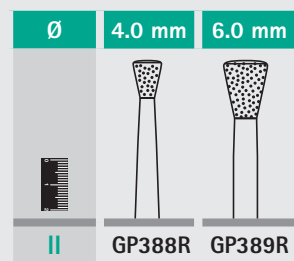

Reverse taper burr coarse diamond
Osteophytenfräser
Fraise pour ostéophytes
Fresa per resezione osteofiti
Fresa de diamante para osteofitos

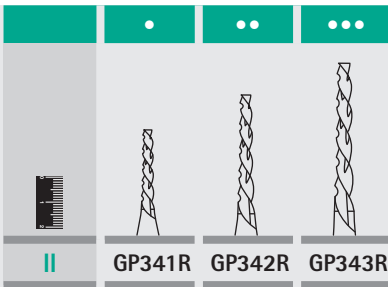
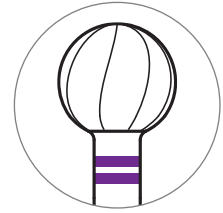

1 sterile

Craniotome cutter – spiral type
 Kraniotomfräser – spiralgig
 Fraise craniotome – en spirale
 Fresa cranéotomo – helicoidal
 Fresa di craniotomo – a spirale

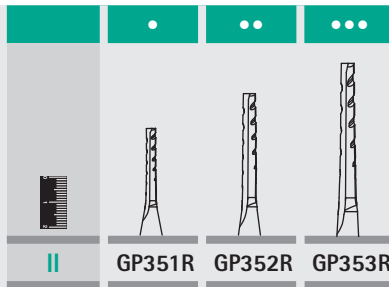

1 sterile

Craniotome cutter – straight type
 Kraniotomfräser – geradverzahnt
 Fraise craniotome – dents droites
 Fresa cranéotomo – dientes rectos
 Fresa di craniotomo – denti dritti

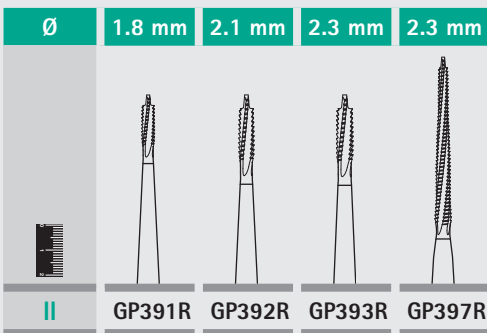

1 sterile

Lindemann

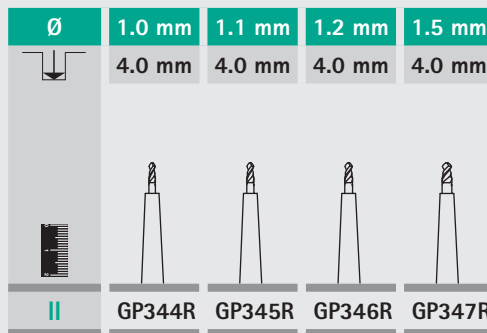

1 sterile

Twist drill
 Spiralbohrer
 Fraise spirale
 Broca espiral
 Punta elicoidale

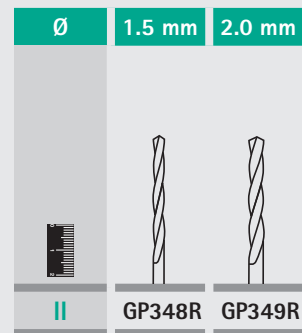

1 sterile

Twist drill
 Spiralbohrer
 Fraise spirale
 Broca espiral
 Punta elicoidale

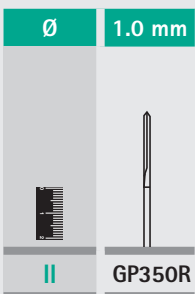

1 sterile

Pin cutter
 Pinfräser
 Fraise pointue
 Fresa punta
 Fresa puntuale

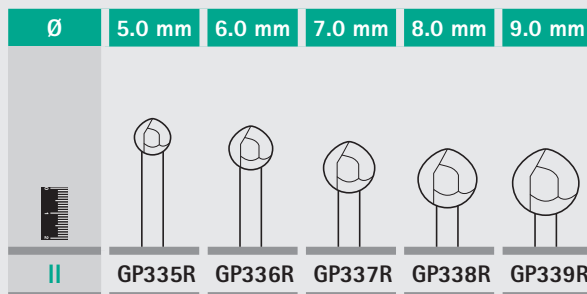

1 sterile

Twin-Cut burr
 Twin-Cut Fräser
 Fraise Twin-Cut
 Fresa Twin-Cut
 Fresa Twin-Cut

AESCULAP® BURRS & BLADES

ELAN 4 BURRS – 2-RING

ELAN 4 Fräser – 2-Ring

Fraises ELAN 4 – 2 anneaux

Fresa ELAN 4 – 2 anillos

Fresa ELAN 4 – 2 anelli

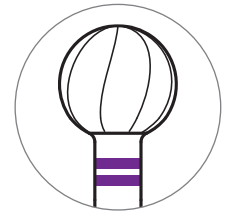

Tungsten Carbide Burrs

Ø	2.3 mm	3.0 mm	4.0 mm	5.0 mm	6.0 mm	7.0 mm	8.0 mm
II	GP301TC	GP302TC	GP304TC	GP306TC	GP307TC	GP308TC	GP309TC



Rosen

Ø	1.2 mm	1.6 mm
II	GP395TC	GP396TC



Taper burr
Konusfräser
Fraise conique
Fresa cónica
Fresa conica

Ø	3.0 mm
II	GP367TC



Neuro cutter
Olivenfräser
Fraise à olive
Fresa oliva
Fresa ad oliva

Burrs for metal dissection

Ø	2.3 mm
II (2)	GP399TC-SU



Side cutter
Zylinderfräser
Fraise cylindrique
Fresa cilíndrica
Fresa cilíndrica

Ø	25 mm
II (2)	GP398SU



Diamond disc
Diamant-Trennscheibe
Disque cou pant diamant
Disco cortante de diamante
Disco tagliante diamante

ELAN 4 BURRS – MIS

ELAN 4 Fräser – MIS
Fraises ELAN 4 – MIS
Fresa ELAN 4 – MIS
Fresa ELAN 4 – MIS

GA860



GB920R

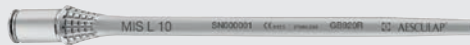

GB921R



GB922R



L10

GB925R

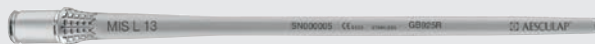

GB926R



GB927R





L13

AESCU LAP[®] BURRS & BLADES



ELAN 4 BURRS – MIS

ELAN 4 Fräser – MIS
 Fraises ELAN 4 – MIS
 Fresa ELAN 4 – MIS
 Fresa ELAN 4 – MIS

Ø	3.0 mm	4.0 mm		
				
L10 (2)	GP422SU	GP423SU		
L13 (2)	GP442SU	GP443SU		







Rosen

Ø	2.0 mm	3.0 mm		
				
L10 (2)	GP420SU	GP421SU		
L13 (2)	GP440SU	GP441SU		







Neuro cutter
 Olivenfräser
 Fraise à olive
 Fresa oliva
 Fresa ad oliva

Ø	3.0 mm	4.0 mm	5.0 mm	
				
L10 (2)	GP432SU	GP433SU	GP434SU	
L13 (2)	GP452SU	GP453SU	GP454SU	







Diamond burr
 Diamantfräser
 Fraise diamantée
 Fresa diamantada
 Frese a diamante

Ø	3.0 mm	4.0 mm	5.0 mm	
				
L10 (2)	GP435SU	GP436SU	GP437SU	
L13 (2)	GP455SU	GP456SU	GP457SU	







Diamond burr extra coarse
 Diamantfräser extra grob
 Fraise diamantée très ruguese
 Fresa diamantada de grano extra grueso
 Frese a diamante extra-grosse

Ø	2.0 mm	3.0 mm	4.0 mm	5.0 mm
				
L10 (2)	GP424SU	GP425SU	GP426SU	GP427SU
L13 (2)	GP444SU	GP445SU	GP446SU	GP447SU



Neuro cutter diamond
 Olivenfräser diamantiert
 Fraise à olive diamantée
 Fresa oliva diamantada
 Fresa ad oliva diamante



















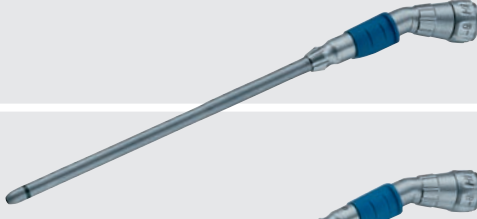

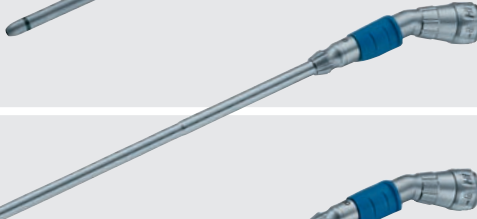

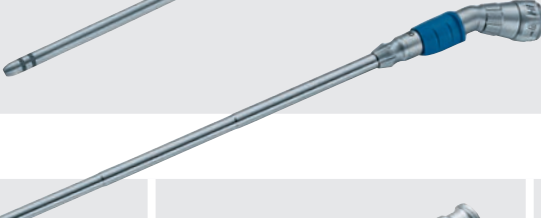



Ø	3.0 mm	4.0 mm	5.0 mm	
				
L10 (2)	GP428SU	GP429SU	GP430SU	
L13 (2)	GP448SU	GP449SU	GP450SU	



Neuro cutter diamond extra coarse
 Olivenfräser diamantiert extra grob
 Fraise à olive diamantée très ruguese
 Fresa oliva diamantada de grano extra grueso
 Fresa ad oliva diamante extra-grosse

Hi-Line XS BURRS

Hi-Line XS Fräser
 Fraises Hi-Line XS
 Fresa Hi-Line XS
 Fresa Hi-Line XS













GB751R 	GB756R 	 I	
GB752R 	GB757R 	 II	
GB753R 	GB758R 	 III	
GB771R 		 XLI	
GB772R 		 XLII	
GB773R 		 XLIII	
GB740R 	GB744R 	GB745R 	▲
	GB741R 	GB746R 	 I
	GB742R 	GB747R 	 II
	GB743R 	GB748R 	 III























AESULAP® BURRS & BLADES

Hi-Line XS BURRS







Hi-Line XS Fräser
 Fraises Hi-Line XS
 Fresa Hi-Line XS
 Fresa Hi-Line XS



Ø	1.0 mm	1.4 mm	1.8 mm	2.3 mm	2.7 mm	3.1 mm	4.0 mm	4.5 mm	5.0 mm	6.0 mm	
											 sterile
I	GE401R*	GE402R*	GE403R	GE404R	GE405R	GE406R	GE407R		GE408R	GE409R	Rosen
II	GE501R	GE502R	GE503R	GE504R	GE505R	GE506R	GE507R		GE508R	GE509R	
III			GE603R	GE604R	GE605R	GE606R	GE607R		GE608R	GE609R	
XLI				GE704R*		GE706R*	GE707R*		GE708R*	GE709R*	
XLII ②								GE282SU		GE281SU	
XLIII ②								GE292SU		GE291SU	

Ø	0.6 mm	1.0 mm	1.8 mm	1.8 mm	2.3 mm	2.7 mm					
											 sterile
I ②	GE469SU	GE471SU		GE473SU		GE475SU					Rosen
II			GE573R*		GE574R*						

Ø	1.0 mm	1.4 mm	1.8 mm	2.3 mm	2.7 mm	3.1 mm	4.0 mm	4.5 mm	5.0 mm	6.0 mm	
											 sterile
I	GE411R*	GE412R	GE413R	GE414R	GE415R	GE416R	GE417R		GE418R	GE419R	Diamond burr
II	GE511R	GE512R	GE513R	GE514R	GE515R	GE516R	GE517R		GE518R	GE519R	Diamantfräser
III			GE613R	GE614R	GE615R	GE616R	GE617R		GE618R	GE619R	Fraise à diamant
XLI				GE714R*		GE716R*	GE717R		GE718R	GE719R*	Fresa diamante
XLII ②								GE286SU		GE284SU	Fresa a diamante
XLIII ②								GE296SU		GE294SU	





* Only R version available; Nur als R Version verfügbar; Seulement disponible en version R; Solo disponible en versión R; Solo disponibile en versione R

Ø	0.6 mm	0.8 mm	1.0 mm	1.8 mm	
					 sterile
I ②	GE459SU	GE460SU	GE461SU	GE463SU	Diamond burr Diamantfräser Fraise diamantée Fresa diamantada Fresa diamantata
II					

Ø	2.3 mm	3.1 mm
		
I	GE424R*	GE425R*
II	GE524R*	GE525R*
III	GE624R*	GE625R*



 sterile

Diamond burr coarse
Diamantfräser grob
Fraise diamantée rugueuse
Fresa diamantada de grano grueso
Frese a diamante grosse

Ø	4.0 mm	5.0 mm	6.0 mm
			
I ②	GE456SU	GE457SU	
II ②	GE556SU	GE557SU	GE558SU
III ②	GE656SU	GE657SU	GE658SU

 sterile

Diamond burr extra coarse
Diamantfräser extra grob
Fraise diamantée très rugueuse
Fresa diamantada de grano extra grueso
Frese a diamante extra-grosse

Ø	5.0 mm	6.0 mm
		
▲	GE396R*	GE397R*







 sterile

Twin-Cut burr
Twin-Cut Fräser
Fraise Twin-Cut
Fresa Twin-Cut
Fresa Twin-Cut

AESCU LAP[®] BURRS & BLADES



Hi-Line XS BURRS

Hi-Line XS Fräser
 Fraises Hi-Line XS
 Fresa Hi-Line XS
 Fresa Hi-Line XS

Ø	1.8 mm	2.3 mm	3.1 mm	3.1 mm	3.1 mm
					
I	GE435R*				
II	GE531R*	GE534R	GE535R	GE555R	
III	GE631R	GE634R	GE635R	GE653R	GE655R*
XLI					



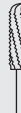

Neuro cutter
 Olivenfräser
 Fraise à olive
 Fresa oliva
 Fresa ad oliva

Ø	4.0 mm	5.0 mm	6.0 mm
			
I			
II	GE548R	GE549R	GE550R*
III	GE648R	GE649R*	GE650R*
XLI	GE729R*		GE712R*





Barrel burr
 Walzenfräser
 Fraise cylindrique
 Fresa cilíndrica
 Fresa tangenziale

Ø	4.0 mm	6.0 mm
		
II	GE544R	GE546R
III	GE644R	GE646R



Barrel burr
 Walzenfräser
 Fraise cylindrique
 Fresa cilíndrica
 Fresa tangenziale

Ø	4.0 mm	6.0 mm
		
II	GE540R	GE542R
III		





Cone burr
 Kegelfräser
 Fraise conique
 Fresa cónica
 Fresa conica

Ø	4.0 mm
	
II	GE539R*
III	GE639R*









Reverse taper burr
 coarse diamond
 Osteophytenfräser
 Fraise pour ostéophytes
 Fresa per resezione osteofiti
 Fresa de diamante para osteofitos

Ø	6.0 mm
	
I	GE437R
II	GE537R







Acorn burr
 Flammenfräser
 Fraise flamme
 Fresa flama
 Fresa di flamma

Ø	1.0 mm	1.1 mm	1.2 mm	1.5 mm	2.0 mm
					
▲	GE390R	GE391R	GE389R	GE395R	
I				GE432R	GE433R
II				GE532R	GE533R
XLI 				GE700SU	

 sterile





Twist drill
Spiralbohrer
Fraise spirale
Broca espiral
Punta elicoidale

		
		
I	GE420R	GE429SU
II	GE520R	GE529SU
III	GE620R	GE629SU

 sterile



Craniotome cutter
Kraniotomfräser
Fraise craniotome
Fresa craneótomo
Fresa di craniotomo

Hi-Line
XS

 / Ø	12 mm / 1.4 mm	20 mm / 1.4 mm
		
▲		
I		
II	GE522R	GE523R



 sterile

Lindemann

Ø	1.0 mm
	
▲	GE392R
I	
II	GE521R

 sterile

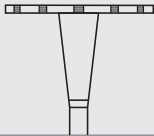
Pin cutter
Pinfräser
Fraise pointue
Fresa punta
Fresa puntuale

Ø	22.0 mm
	
▲	
I 	GE430SU
II 	GE530SU

 sterile

Diamond disc
Diamant-Trennscheibe
Disque cou pant diamant
Disco cortante de diamante
Disco tagliente diamante

AESULAP[®] BURRS & BLADES

Hi-Line XS BURRS (TUNGSTEN CARBIDE)

Hi-Line XS Fräser (Hartmetall)

Fraises Hi-Line XS (Carbure)

Fresa Hi-Line XS (Carburo sinterizado)

Fresa Hi-Line XS (Carburo di tungsteno)

Ø 2.35 mm

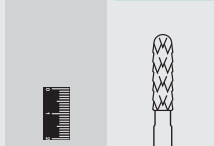

II ② GE528SU

III ② GE628SU

1 sterile

Ø 5.0 mm

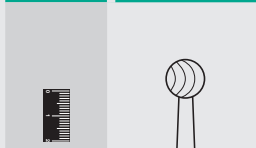

II ②

III ② GE608TC-SU

1 sterile

Rosen

Ø 3.1 mm

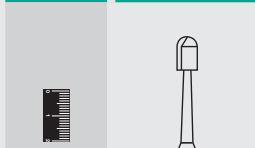

II ② GE535TC-SU*



























III ② GE635TC-SU

1 sterile

Neuro cutter
Olivenfräser
Fraise à olive
Fresa oliva
Fresa as oliva

Hi-Line BURRS

Hi-Line Fräser
 Fraises Hi-Line
 Fresa Hi-Line
 Fresa Hi-Line













<p>GB529R</p> 	<p>GB519R</p> 	 
<p>GB530R</p> 	<p>GB533R</p> 	 
<p>GB531R</p> 	<p>GB534R</p> 	 
<p>GB532R</p> 	<p>GB535R</p> 	 
<p>GB520R</p> 	<p>GB536R</p> 	 
	<p>GB537R</p> 	 
	<p>GB538R</p> 	 





















AESCULAP® BURRS & BLADES

Hi-Line BURRS

Hi-Line Fräser
Fraises Hi-Line
Fresa Hi-Line
Fresa Hi-Line







Ø	1.0 mm	1.4 mm	2.3 mm	3.1 mm	4.5 mm	6.0 mm	8.0 mm			
										 sterile
					GD824R	GD825R				Rosen
			GD807R	GD738R	GD741R	GD744R	GD747R			
	GD733R	GD736R	GD808R	GD739R	GD742R	GD745R	GD748R			
			GD809R	GD740R	GD743R	GD746R	GD749R			

Ø	1.0 mm	1.4 mm	2.3 mm	3.1 mm	4.5 mm	6.0 mm				
										 sterile
					GD831R	GD832R				Diamond burr Diamantfräser Fraise à diamant Fresa diamante Fresa a diamante
			GD792R	GD795R	GD798R	GD801R				
	GD787R	GD790R	GD793R	GD796R	GD799R	GD802R				
			GD794R	GD797R	GD800R	GD803R				

Ø	2.3 mm	3.1 mm
		
		
	GD692R	GD695R
	GD693R	GD696R





 sterile

Diamond burr coarse
Diamantfräser grob
Fraise diamantée rugueuse
Fresa diamantada de grano grueso
Fresa a diamante grosse

Ø	4.5 mm	6.5 mm
		
		
	GD714R	GD718R
	GD716R	GD719R

 sterile

Diamond burr extra coarse
Diamantfräser extra grob
Fraise diamantée très rugueuse
Fresa diamantada de grano extra grueso
Fresa a diamante extra-grosse

Ø	
	
	GD804R
	GD805R
	GD806R

 sterile

Craniotome cutter
Craniotomfräser
Fraise craniotome
Fresa craneótomo
Fresa di craniotomo

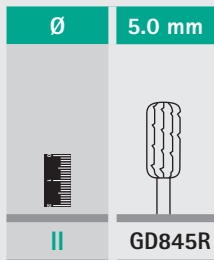

 sterile

Barrel burr
Walzenfräser
Fraise cylindrique
Fresa cilíndrica
Fresa tangenziale

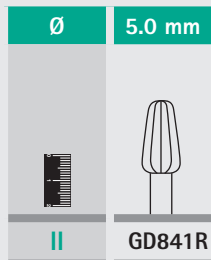

 sterile

Cone burr
Kegelfräser
Fraise conique
Fresa cónica
Fresa conica

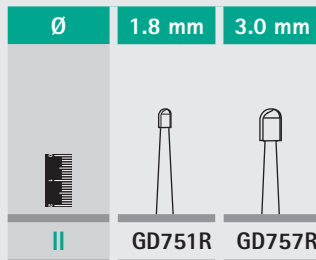

 sterile



Neuro cutter
Olivenfräser
Fraise à olive
Fresa oliva
Fresa ad oliva



AESCULAP® BURRS & BLADES



Hi-Line BURRS

Hi-Line Fräser
 Fraises Hi-Line
 Fresa Hi-Line
 Fresa Hi-Line

Ø	1.5 mm	2.0 mm
		
▲	GD836R	
I	GD726R	GD729R
II	GD727R	GD730R

 sterile

Twist drill
 Spiralbohrer
 Fraise spirale
 Broca espiral
 Punta elicoidale

 / Ø	16 mm / 1.65 mm
	
▲	GD839R

 sterile

Lindemann

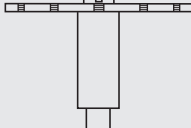
Ø	25 mm
	
II	GD763R

 sterile

Diamond disc
 Diamant-Trennscheibe
 Disque cou pant diamant
 Disco cortante de diamante
 Disco tagliente diamante

2.35 mm BURRS

2,35 mm Fräser
 Fraises 2,35 mm
 Fresa 2,35 mm
 Fresa 2,35 mm

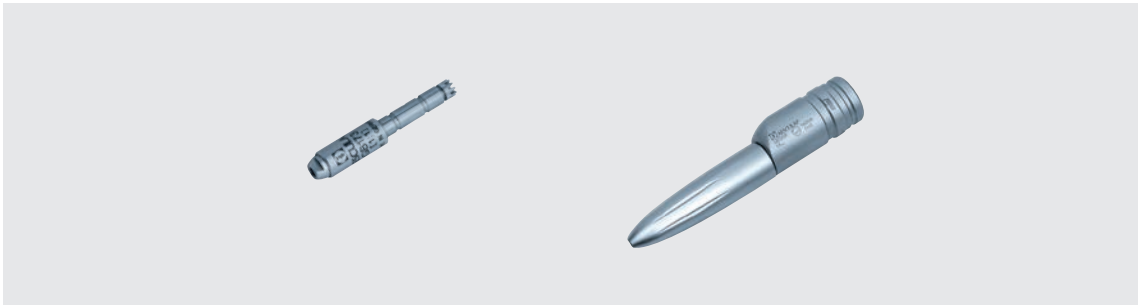

GB173

GB376R/GB380R

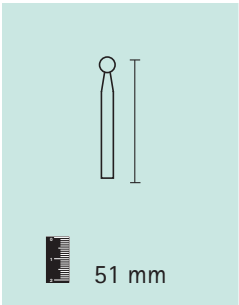

51 mm

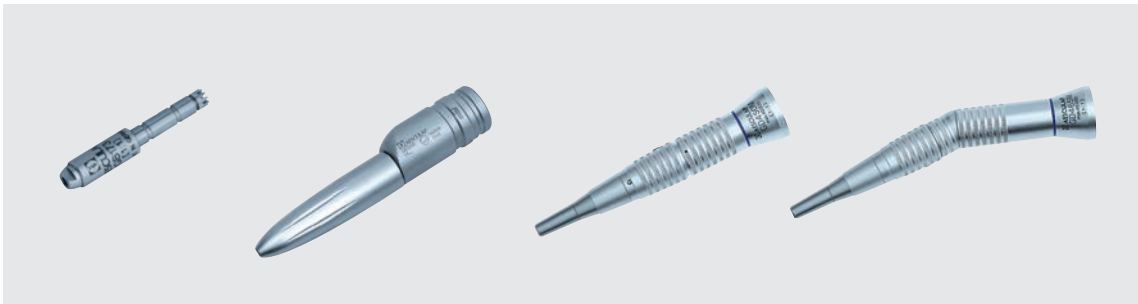

GB173

GB376R/GB380R

GD450

GD465/GD455

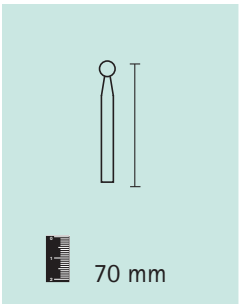

70 mm

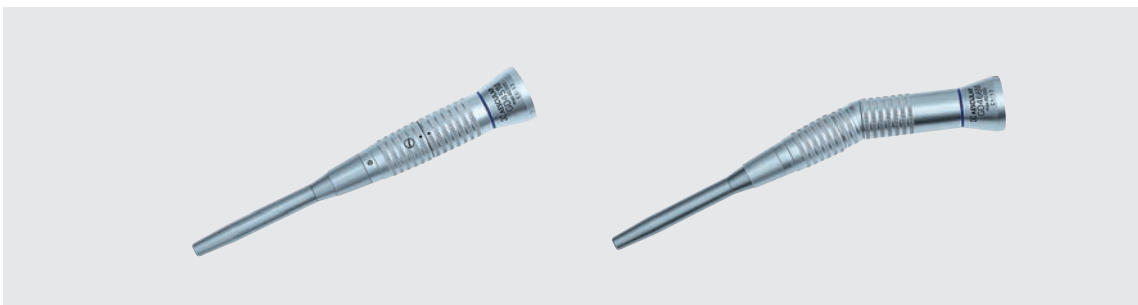

GD451

GD466/GD456

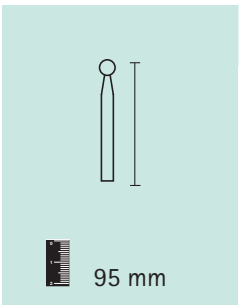

95 mm

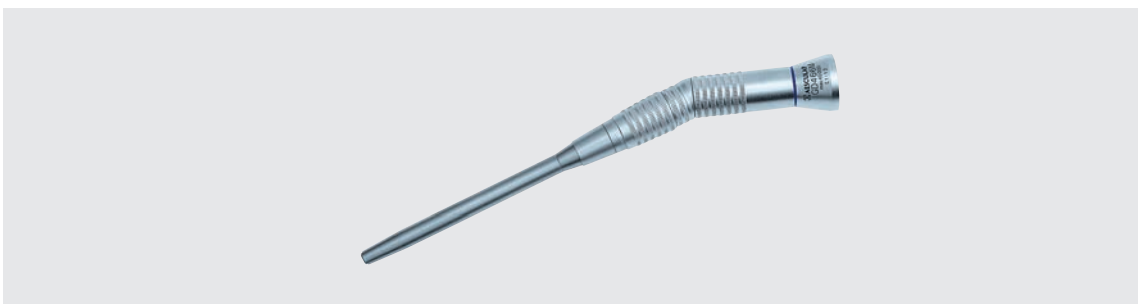

GB124R

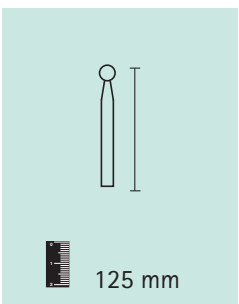

125 mm



2.35 mm

AESCULAP® BURRS & BLADES

2.35 mm BURRS

2,35 mm Fräser
 Fraises 2,35 mm
 Fresa 2,35 mm
 Fresa 2,35 mm

Ø mm	0.60	0.70	0.80	1.00	1.40	1.80	2.30	2.70	3.10	3.50	4.00	4.50	5.00	6.00	7.00
ISO	006	007	008	010	014	018	023	027	031	035	040	045	050	060	070

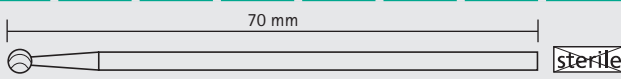
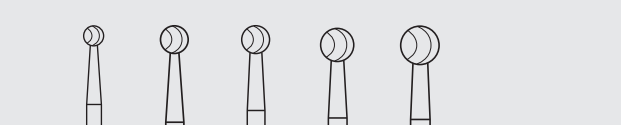



70 mm

GC900R GC901R GC902R GC903R GC904R



70 mm



Allport

Ø mm	0.60	0.70	0.80	1.00	1.40	1.80	2.30	2.70	3.10	3.50	4.00	4.50	5.00	6.00	7.00
ISO	006	007	008	010	014	018	023	027	031	035	040	045	050	060	070

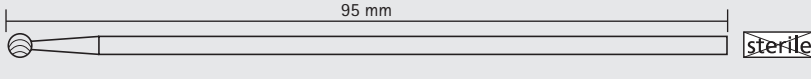
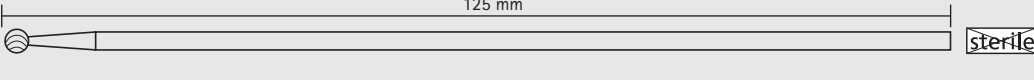
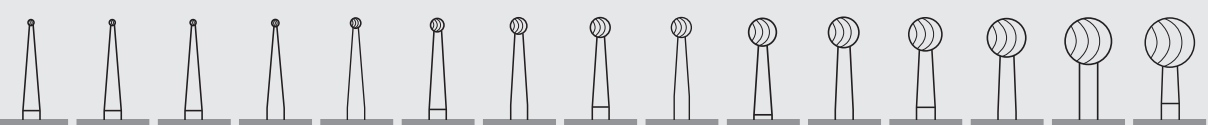
70 mm



GD041R GD042R GD043R GD044R GD045R GD046R GD047R GD048R GD049R GD050R GD051R GD052R GD053R GD054R GD055R

95 mm

GD145R GD146R GD147R GD148R GD149R GD150R GD151R GD152R GD153R GD154R GD155R

125 mm

GD246R GD247R GD248R GD249R GD250R GD251R GD252R GD253R GD254R GD255R

Rosen

Ø mm	0.60	0.70	0.80	1.00	1.40	1.80	2.30	2.70	3.10	3.50	4.00	4.50	5.00	6.00	7.00
ISO	006	007	008	010	014	018	023	027	031	035	040	045	050	060	070

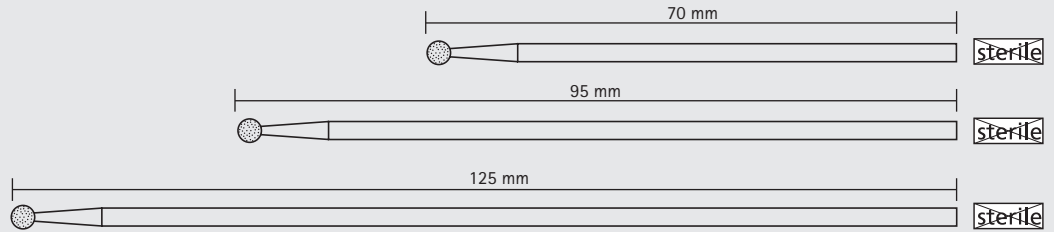

70 mm	GD021R	GD022R	GD023R	GD024R	GD025R	GD026R	GD027R	GD028R	GD029R	GD030R	GD031R	GD032R	GD033R	GD034R	GD035R
95 mm					GD125R	GD126R	GD127R	GD128R	GD129R	GD130R	GD131R	GD132R	GD133R	GD134R	GD135R
125 mm					GD225R	GD226R	GD227R	GD228R	GD229R	GD230R	GD231R	GD232R	GD233R	GD234R	GD235R



Diamond burr – Diamantfräser – Fraise diamantée – Fresa diamantada – Frese a diamante

2.35 mm



Ø	4.0 mm	5.0 mm	6.0 mm	7.0 mm				
70 mm	GD071R	GD072R	GD073R	GD074R				



Cone burr – Kegelfräser – Fraise conique – Fresa cónica – Fresa conica

Ø	4.0 mm	5.0 mm	6.0 mm	7.0 mm				
70 mm	GD081R	GD082R	GD083R	GD084R				
95 mm		GD182R		GD184R				
125 mm		GD282R		GD284R				

2.35 mm



Barrel burr – Walzenfräser – Fraise cylindrique – Fresa cilíndrica – Fresa tangenziale

AESCULAP® BURRS & BLADES

2.35 mm BURRS

2,35 mm Fräser
 Fraises 2,35 mm
 Fresa 2,35 mm
 Fresa 2,35 mm

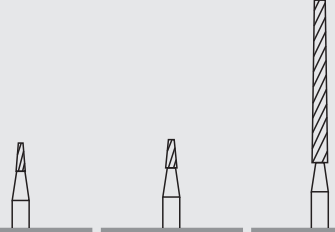
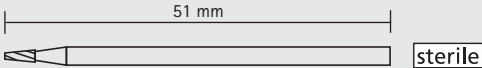
 / Ø	4.0/1.2 mm	4.5/1.6 mm	23.0/2.2 mm					
								
	GD950R	GD951R	GD953R					
	TC	TC						

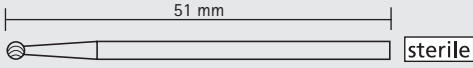

Taper burr – Konusfräser – Fraise conique – Fresa cónica – Fresa conica

Ø	2.3 mm							
								
	GD961R							
	TC							

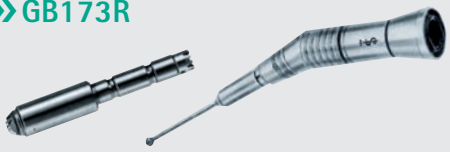

Rosen

 	Ø				
GC880R	1.4 mm	58 mm	28 mm		 »GB173R 
GC884R	2 mm	65 mm	35 mm		
GC887R	2.7 mm	67 mm	37 mm		
GC890R	3.2 mm	67 mm	37 mm		

TWIST DRILLS, INTRAMEDULLARY REAMERS

Spiralbohrer, Markraumbohrer

Forets hélicoïdaux, foret intramédullaire

Broca helicoidal, broca para cavidad medular

Perforatore spiralato, perforatore midollare



AESCALAP® BURRS & BLADES







TWIST DRILLS, INTRAMEDULLARY REAMERS

Spiralbohrer, Markraumborher

Forets hélicoïdaux, foret intramédullaire





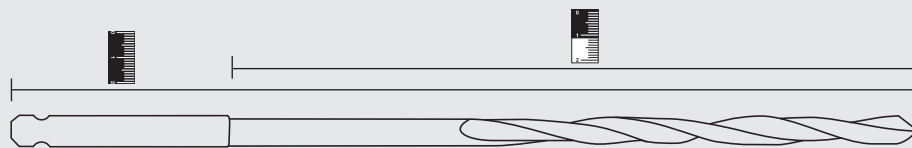

Broca helicoidal, broca para cavidad medular

Perforatore spirato, perforatore midollare

 sterile	Ø			 sterile	Ø		
GC310R	1.1 mm	60 mm	35 mm	GC319R	3.2 mm	145 mm	120 mm
GC312R	1.5 mm	85 mm	60 mm	GC372R	3.2 mm	195 mm	170 mm
GC314R	2 mm	100 mm	75 mm	GC320R	3.5 mm	110 mm	85 mm
GC378R	2 mm	125 mm	100 mm	GC375R	3.5 mm	195 mm	170 mm
GC315R	2.5 mm	110 mm	85 mm	GC323R	4.5 mm	145 mm	120 mm
GC380R	2.5 mm	125 mm	100 mm	GC377R	4.5 mm	200 mm	175 mm
GC316R	2.7 mm	100 mm	75 mm				

AO
small



 sterile	Ø			 sterile	Ø		
GC002R	1.5 mm	70 mm	45 mm	GC010R	3.5 mm	100 mm	75 mm
GC004R	2 mm	100 mm	75 mm	GC395R	3.5 mm	210 mm	170 mm
GC006R	2.5 mm	100 mm	75 mm	GC012R	4 mm	110 mm	85 mm
GC391R	2.5 mm	175 mm	135 mm	GC013R	4.5 mm	150 mm	125 mm
GC007R	2.8 mm	100 mm	75 mm	GC397R	4.5 mm	210 mm	170 mm
GC008R	3 mm	100 mm	75 mm	GC014R	5 mm	160 mm	135 mm
GC009R	3.2 mm	100 mm	75 mm	GC016R	6 mm	160 mm	135 mm

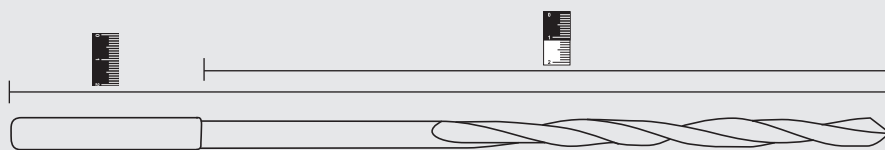



∅



GC355R	2.7/3.5/4 mm	130 mm	2.5 mm
GC354R	4.5-6.5 mm	130 mm	3.5 mm

A0
small



∅



GC461R	1.1 mm	65 mm	35 mm
GC462R	1.5 mm	75 mm	45 mm
GC464R	2 mm	90 mm	60 mm



GC458R	1.5 mm	50 mm

Dental

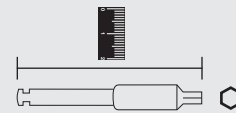
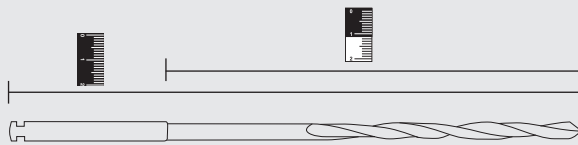

∅



GC880R	1.4 mm	58 mm	28 mm
GC884R	2 mm	65 mm	35 mm
GC887R	2.7 mm	67 mm	37 mm
GC890R	3.2 mm	67 mm	37 mm

» GB173R

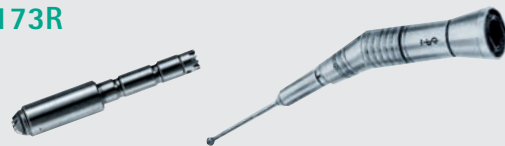

∅
2.35 mm

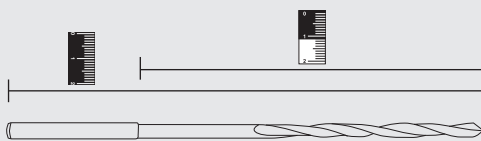

AESULAP® BURRS & BLADES





TWIST DRILLS, INTRAMEDULLARY REAMERS

Spiralbohrer, Markraumböhrer

Forets hélicoïdaux, foret intramédullaire

Broca helicoidal, broca para cavidad medular

Perforatore spiralato, perforatore midollare

 sterile	Ø	 sterile	Ø	 sterile	Ø	 sterile	Ø
GE668R*	9 mm	GE674R*	12 mm	GE682R*	16 mm	GE691R	21 mm
GE669R*	9.5 mm	GE675R*	12.5 mm	GE684R*	17 mm	GE692R	22 mm
GE670R*	10 mm	GE676R*	13 mm	GE685R	17.5 mm	GE693R	23 mm
GE671R*	10.5 mm	GE678R*	14 mm	GE686R*	18 mm	GE694R	24 mm
GE672R*	11 mm	GE679R	14.5 mm	GE688R*	19 mm		
GE673R*	11.5 mm	GE680R*	15 mm	GE690R	20 mm		

Burr head
Bohrkopf
Tête de forage
Trépano
Testa perforante

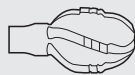

 sterile	
GE666R*	470 mm

Burr shaft
Bohrerschaft
Tige de forage
Vástago de broca
Gambo perforatore

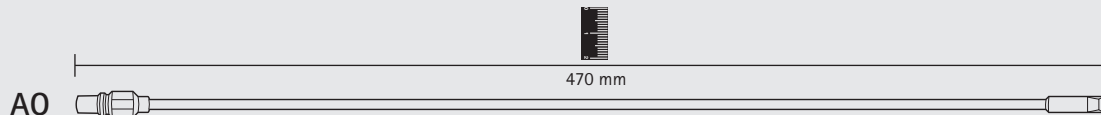

 sterile		Ø
GE663S*	800 mm	2.5 mm

Guide wire
Führungsdraht
Fil de guidage
Alambre guía
Filo guida

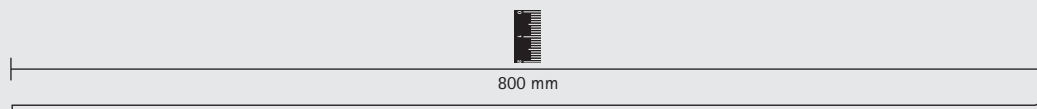

SKULL PERFORATORS, CRANIOTOME BURRS

Schädeltrepane, Kraniotomfräser

Trépans crâniens, fraises de craniotome

Trépanos y fresas para craneótomo

Perforatori cranici, frese per craniotomia

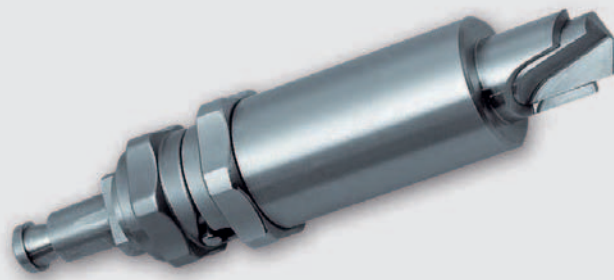

AESCULAP® BURRS & BLADES

SKULL PERFORATORS, CRANIOTOME BURRS

Schädeltrepane, Kraniotomfräser
 Trépans crâniens, fraises de craniotome
 Trépanos y fresas para craneótomo
 Perforatori cranici, frese per craniotomia



Ø/mm

GB300R	6/9	4.0 mm*
GB302R	9/12	5.0 mm*
GB304R	12/15	5.4 mm*

Hudson

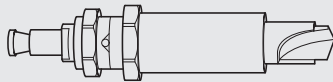

Ø/mm

TE561	6/9	4.0 mm*
TE562	9/12	5.0 mm*
TE563	12/15	5.4 mm*



* Minimal cranial bone thickness
 Mindestdicke des Schädelknochens
 Épaisseur minimal de l'os crânien
 Grosor mínimo del hueso craneal
 Spessore minimo dell'osso cranico

* Minimal cranial bone thickness
 Mindestdicke des Schädelknochens
 Épaisseur minimal de l'os crânien
 Grosor mínimo del hueso craneal
 Spessore minimo dell'osso cranico



Ø

GC303R	20 mm	1.6 mm
GC307R	20 mm	2.0 mm

GC303R



GC307R



» GB265R, GB268R



GC304R

» GB292

GC304R

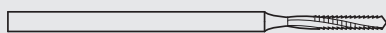

OTHERS

Sonstige

Divers

Otros

Altro



etc.

AESCULAP® BURRS & BLADES

DERMATOLOGY

Dermatologie
 Dermatologie
 Dermatología
 Dermatologia



GB228R

Wagner



» GA340, GA341, GB231R, GA670



Enlargement factor – Vergrößerungsfaktor – Facteur d'agran-
 dissement – Factor de extensión – Fattore d'ingrandimento

BA721

1:1.5

BA722

1:3

BA723

1:6

» BA720R

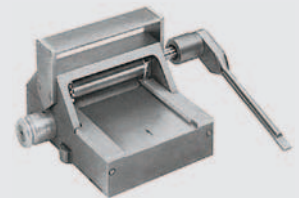

Skin Graft
 Mesher



CARE AND MAINTENANCE

Pflege und Aufbereitung
 Entretien et maintenance
 Conservación y mantenimiento
 Cura e manutenzione



GB600850
 ELAN 4 air



GB600860
 ELAN 4 electro



GB600880
 Acculan 4 small drill



GB600840
 Acculan 4, Acculan 3Ti



GB600870
 ELAN 4 MIS shafts,
 microspeed uni XS



GB600820
 HiLAN, HiLAN XS, Hi-Line
 (XS, XXS), Microspeed EC,
 microspeed uni, microLAN,
 miniLAN



GB600830
 mini-Line



GB600810
 micro-Line



GB600 
 Sterilit Power Systems
 consisting parts:
 3x GB600890 spray tube

etc.

AESCU LAP[®] BURRS & BLADES

CARE AND MAINTENANCE

Pflege und Aufbereitung

Entretien et maintenance

Conservación y mantenimiento

Cura e manutenzione

ECCOS fixation for saw blades – ECCOS Halterungen für Sägeblätter – ECCOS fixation pour lames de scie – ECCOS soporte para hojas de sierra – ECCOS supporto per lame de sega

GB481R



GB729R



GB720R



GB730R



ECCOS fixation for burrs – ECCOS Halterungen für Fräser – ECCOS fixation pour fraises – ECCOS soporte para fresas – ECCOS supporto per frese

Hi-Line/Hi-Line XS

GB613R

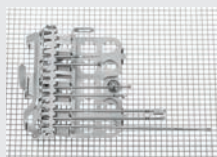

ELAN 4

GB718R



ECCOS fixation cranial perforator – ECCOS Halterung für Schädeltrepan – ECCOS fixation pour trepan cranien – ECCOS soporte para trepano cranial – ECCOS supporto per trapano craniale

GB572R

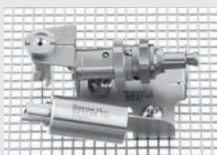

INDEX, UNIVERSAL TOOL ATTACHMENTS, SIGNS AND SYMBOLS

Index, universelle Werkzeuganschlüsse, Zeichenerklärung

Sommaire, raccords d'outil universels, explication des symboles

Índice, conexiones universales para útiles, explicación de los símbolos

Indice, attacchi utensili universali, spiegazione dei simboli

A B C
1 2 3

AESCULAP® BURRS & BLADES





INDEX, UNIVERSAL TOOL ATTACHMENTS, SIGNS AND SYMBOLS





Index, Universelle Werkzeuganschlüsse, Zeichenerklärung

Sommaire, Raccords d'outil universels, Explication des symboles

Índice, Conexiones universales para útiles, Explicación de los símbolos

Indice, Attacchi utensili universali, Spiegazione dei simboli

Art. No.		Art. No.		Art. No.		Art. No.		Art. No.	
BA721	74	GC139R	18	GC458R	69	GC867R	64	GD047R	62
BA722	74	GC148R	18	GC461R	69	GC880R	66, 69	GD048R	62
BA723	74	GC149R	18	GC462R	69	GC884R	66, 69	GD049R	62
		GC203R	10	GC464R	69	GC887R	66, 69	GD050R	62
GB228R	74	GC207R	10	GC570R	37	GC890R	66, 69	GD051R	62
GB300R	72	GC208R	10	GC575R	37	GC900R	62	GD052R	62
GB302R	72	GC209R	10	GC576R	37	GC901R	62	GD053R	62
GB304R	72	GC211R	10, 15	GC578R	37	GC902R	62	GD054R	62
GB481R	76	GC215R	11	GC580R	37	GC903R	62	GD055R	62
GB572R	76	GC216R	11	GC583R	36	GC905R	29	GD062R	64
GB600	75	GC217R	11	GC584R	36	GC906R	28	GD063R	64
GB600810	75	GC218R	11	GC585R	36	GC907R	28	GD064R	64
GB600820	75	GC219R	11	GC586R	36	GC909R	28	GD071R	65
GB600830	75	GC261R	34	GC587R	36	GC912R	28	GD072R	65
GB600840	75	GC263R	34	GC604R	19	GC915R	30	GD073R	65
GB600850	75	GC265R	34	GC605R	19	GC919R	30	GD074R	65
GB600860	75	GC267R	34	GC615R	24, 29	GC921R	30	GD081R	65
GB600870	75	GC269R	34	GC633R	24, 29	GC923R	30	GD082R	65
GB600880	75	GC271R	35	GC634R	19	GC925R	30	GD083R	65
GB613R	76	GC273R	35	GC635R	19	GC926R	30	GD084R	65
GB718R	76	GC277R	35	GC636R	19	GC927R	29	GD125R	63
GB720R	76	GC279R	35	GC648R	20			GD126R	63
GB729R	76	GC303R	72	GC649R	20	GD021R	63	GD127R	63
GB730R	76	GC304R	72	GC650R	20	GD022R	63	GD128R	63
GC002R	68	GC307R	72	GC651R	20	GD023R	63	GD129R	63
GC004R	68	GC310R	68	GC652R	20	GD024R	63	GD130R	63
GC006R	68	GC312R	68	GC654R	29	GD025R	63	GD131R	63
GC007R	68	GC314R	68	GC655R	28	GD026R	63	GD132R	63
GC008R	68	GC315R	68	GC657R	28	GD027R	63	GD133R	63
GC009R	68	GC316R	68	GC658R	28	GD028R	63	GD134R	63
GC010R	68	GC319R	68	GC675R	15	GD029R	63	GD135R	63
GC012R	68	GC320R	68	GC681R	15	GD030R	63	GD145R	62
GC013R	68	GC323R	68	GC682R	16	GD031R	63	GD146R	62
GC014R	68	GC354R	69	GC683R	16	GD032R	63	GD147R	62
GC016R	68	GC355R	69	GC761R	26	GD033R	63	GD148R	62
GC114R	18	GC372R	68	GC766R	26	GD034R	63	GD149R	62
GC115R	18	GC375R	68	GC767R	26	GD035R	63	GD150R	62
GC124R	18	GC377R	68	GC768R	26	GD041R	62	GD151R	62
GC125R	18	GC378R	68	GC769R	26	GD042R	62	GD152R	62
GC127R	18	GC380R	68	GC770R	26	GD043R	62	GD153R	62
GC128R	18	GC391R	68	GC771R	26	GD044R	62	GD154R	62
GC137R	18	GC395R	68	GC864R	64	GD045R	62	GD155R	62
GC138R	18	GC397R	68	GC866R	64	GD046R	62	GD162R	64

Art. No.		Art. No.		Art. No.		Art. No.		Art. No.	
GD164R	64	GD695R	58	GD806R	58	GE291SU	52	GE463SU	53
GD182R	65	GD696R	58	GD807R	58	GE292SU	52	GE469SU	52
GD184R	65	GD714R	58	GD808R	58	GE294SU	52	GE471SU	52
GD196R	64	GD716R	58	GD809R	58	GE296SU	52	GE473SU	52
GD225R	63	GD718R	58	GD824R	58	GE389R	55	GE475SU	52
GD226R	63	GD719R	58	GD825R	58	GE390R	55	GE501R	52
GD227R	63	GD726R	60	GD831R	58	GE391R	55	GE502R	52
GD228R	63	GD727R	60	GD832R	58	GE392R	55	GE503R	52
GD229R	63	GD729R	60	GD836R	60	GE395R	55	GE504R	52
GD230R	63	GD730R	60	GD839R	60	GE396R	53	GE505R	52
GD231R	63	GD733R	58	GD841R	59	GE397R	53	GE506R	52
GD232R	63	GD736R	58	GD845R	59	GE401R	52	GE507R	52
GD233R	63	GD738R	58	GD950R	66	GE402R	52	GE508R	52
GD234R	63	GD739R	58	GD951R	66	GE403R	52	GE509R	52
GD235R	63	GD740R	58	GD953R	66	GE404R	52	GE511R	52
GD246R	62	GD741R	58	GD961R	66	GE405R	52	GE512R	52
GD247R	62	GD742R	58			GE406R	52	GE513R	52
GD248R	62	GD743R	58	GE231SU	12	GE407R	52	GE514R	52
GD249R	62	GD744R	58	GE232SU	12	GE408R	52	GE515R	52
GD250R	62	GD745R	58	GE233SU	12	GE409R	52	GE516R	52
GD251R	62	GD746R	58	GE234SU	12	GE411R	52	GE517R	52
GD252R	62	GD747R	58	GE235SU	12	GE412R	52	GE518R	52
GD253R	62	GD748R	58	GE236SU	12	GE413R	52	GE519R	52
GD254R	62	GD749R	58	GE238SU	12	GE414R	52	GE520R	55
GD255R	62	GD751R	59	GE239SU	12	GE415R	52	GE521R	55
GD262R	64	GD757R	59	GE240SU	12	GE416R	52	GE522R	55
GD264R	64	GD763R	60	GE241SU	12	GE417R	52	GE523R	55
GD282R	65	GD787R	58	GE242SU	12	GE418R	52	GE524R	53
GD284R	65	GD790R	58	GE243SU	13	GE419R	52	GE525R	53
GD320R	27	GD792R	58	GE244SU	13	GE420R	55	GE528SU	56
GD321R	27	GD793R	58	GE245SU	13	GE424R	53	GE529SU	55
GD322R	27	GD794R	58	GE246SU	13	GE425R	53	GE530SU	55
GD323R	27	GD795R	58	GE247SU	13	GE429SU	55	GE531R	54
GD390R	17	GD796R	58	GE248SU	13	GE430SU	55	GE532R	55
GD391R	17	GD797R	58	GE249SU	13	GE432R	55	GE533R	55
GD392R	17	GD798R	58	GE252R	14	GE433R	55	GE534R	54
GD393R	17	GD799R	58	GE253R	14	GE435R	54	GE535R	54
GD394R	17	GD800R	58	GE254R	14	GE437R	54	GE535TC-SU	56
GD395R	17	GD801R	58	GE255R	14	GE456SU	53	GE537R	54
GD396R	17	GD802R	58	GE281SU	52	GE457SU	53	GE539R	54
GD397R	17	GD803R	58	GE282SU	52	GE459SU	53	GE540R	54
GD692R	58	GD804R	58	GE284SU	52	GE460SU	53	GE542R	54
GD693R	58	GD805R	58	GE286SU	52	GE461SU	53	GE544R	54

AESCALAP® BURRS & BLADES





INDEX, UNIVERSAL TOOL ATTACHMENTS, SIGNS AND SYMBOLS





Index, Universelle Werkzeuganschlüsse, Zeichenerklärung

Sommaire, Raccords d'outil universels, Explication des symboles

Índice, Conexiones universales para útiles, Explicación de los símbolos

Indice, Attacchi utensili universali, Spiegazione dei simboli

Art. No.		Art. No.		Art. No.		Art. No.		Art. No.	
GE546R	54	GE657SU	53	GP113TC	44	GP161R	42	GP220R	43
GE548R	54	GE658SU	53	GP114R	40	GP162R	42	GP224R	43
GE549R	54	GE663S	70	GP115R	40	GP163R	42	GP225R	43
GE550R	54	GE666R	70	GP116R	40	GP164R	42	GP226R	43
GE555R	54	GE668R	70	GP117R	40	GP165R	42	GP228R	43
GE556SU	53	GE669R	70	GP118R	40	GP166R	42	GP229R	43
GE557SU	53	GE670R	70	GP119TC	44	GP168R	42	GP230R	43
GE558SU	53	GE671R	70	GP120R	40	GP169R	42	GP232R	44
GE573R	52	GE672R	70	GP121R	40	GP170R	42	GP233R	44
GE574R	52	GE673R	70	GP122R	40	GP173R	42	GP234R	43
GE603R	52	GE674R	70	GP123R	40	GP174R	42	GP235R	43
GE604R	52	GE675R	70	GP124R	40	GP175R	42	GP236R	43
GE605R	52	GE676R	70	GP124TC	44	GP176R	42	GP238R	44
GE606R	52	GE678R	70	GP125R	40	GP177R	42	GP240R	44
GE607R	52	GE679R	70	GP126R	40	GP184R	40	GP241R	44
GE608R	52	GE680R	70	GP126TC	44	GP185R	40	GP242R	44
GE608TC-SU	56	GE682R	70	GP127R	40	GP186R	40	GP243R	44
GE609R	52	GE684R	70	GP128R	40	GP187R	40	GP301R	45
GE613R	52	GE685R	70	GP128TC	44	GP188R	44	GP301TC	48
GE614R	52	GE686R	70	GP129R	40	GP189R	44	GP302R	45
GE615R	52	GE688R	70	GP129TC	44	GP190R	44	GP302TC	48
GE616R	52	GE690R	70	GP133R	40	GP193R	44	GP303R	45
GE617R	52	GE691R	70	GP134R	40	GP194R	44	GP304R	45
GE618R	52	GE692R	70	GP135R	40	GP195R	44	GP304TC	48
GE619R	52	GE693R	70	GP136R	40	GP196R	44	GP305R	45
GE620R	55	GE694R	70	GP141R	41	GP201R	43	GP306R	45
GE624R	53	GE700SU	55	GP142R	41	GP202R	43	GP306TC	48
GE625R	53	GE704R	52	GP143R	41	GP203R	43	GP307R	45
GE628SU	56	GE706R	52	GP144R	41	GP204R	43	GP307TC	48
GE629SU	55	GE707R	52	GP145R	41	GP205R	43	GP308R	45
GE631R	54	GE708R	52	GP146R	41	GP208R	43	GP308TC	48
GE634R	54	GE709R	52	GP147R	41	GP209R	43	GP309R	45
GE635R	54	GE712R	54	GP148R	41	GP210R	43	GP309TC	48
GE635TC-SU	56	GE714R	52	GP149R	41	GP210TC	44	GP311R	45
GE639R	54	GE716R	52	GP150R	41	GP211R	43	GP312R	45
GE644R	54	GE717R	52	GP151R	41	GP212R	43	GP313R	45
GE646R	54	GE718R	52	GP152R	41	GP213R	43	GP314R	45
GE648R	54	GE719R	52	GP153R	41	GP214R	43	GP315R	45
GE649R	54	GE729R	54	GP154R	41	GP215R	43	GP316R	45
GE650R	54			GP155R	41	GP216R	43	GP317R	45
GE653R	54	GP111R	40	GP156R	41	GP217R	43	GP321R	45
GE655R	54	GP112R	40	GP157R	41	GP218R	43	GP322R	45
GE656SU	53	GP113R	40	GP158R	41	GP219R	43	GP323R	45

Art. No.		Art. No.		Art. No.		Art. No.	
GP324R	45	GP385R	46	GP455SU	50	GP553R	23
GP325R	45	GP386R	46	GP456SU	50	GP554R	23
GP328R	45	GP388R	46	GP457SU	50	GP557R	25
GP329R	45	GP389R	46	GP491R	6	GP558R	25
GP330R	45	GP391R	47	GP492R	6	GP559R	24
GP335R	47	GP392R	47	GP493R	6	GP561R	23
GP336R	47	GP393R	47	GP494R	6	GP562R	23
GP337R	47	GP395TC	48	GP495R	6	GP563R	23
GP338R	47	GP396TC	48	GP496R	6	GP564R	23
GP339R	47	GP397R	47	GP497R	6	GP565R	24
GP341R	47	GP398SU	48	GP501R	7	GP567R	25
GP342R	47	GP399TC-SU	48	GP502R	7	GP569R	24
GP343R	47	GP420SU	50	GP504R	7	GP575R	24
GP344R	47	GP421SU	50	GP505R	7	GP576R	24
GP345R	47	GP422SU	50	GP511R	9	GP580R	32
GP346R	47	GP423SU	50	GP514R	7	GP581R	33
GP347R	47	GP424SU	50	GP515R	7	GP582R	32
GP348R	47	GP425SU	50	GP516R	7	GP583R	33
GP349R	47	GP426SU	50	GP518R	7	GP584R	33
GP350R	47	GP427SU	50	GP521R	7	GP586R	32
GP351R	47	GP428SU	50	GP522R	7	GP587R	33
GP352R	47	GP429SU	50	GP523R	7	GP588R	33
GP353R	47	GP430SU	50	GP524R	7	GP590R	32
GP355R	46	GP432SU	50	GP526R	9	GP591R	33
GP356R	46	GP433SU	50	GP527R	9	GP594R	33
GP357R	46	GP434SU	50	GP528R	9	GP595R	33
GP358R	46	GP435SU	50	GP529R	9	GP598R	33
GP361R	46	GP436SU	50	GP530R	9		
GP362R	46	GP437SU	50	GP531R	9	TE561	72
GP363R	46	GP440SU	50	GP532R	9	TE562	72
GP364R	46	GP441SU	50	GP535R	8	TE563	72
GP367R	46	GP442SU	50	GP536R	8		
GP367TC	48	GP443SU	50	GP537R	8		
GP370R	46	GP444SU	50	GP538R	8		
GP371R	46	GP445SU	50	GP539R	8		
GP374R	46	GP446SU	50	GP541R	22		
GP375R	46	GP447SU	50	GP542R	22		
GP376R	46	GP448SU	50	GP543R	22		
GP378R	46	GP449SU	50	GP544R	22		
GP379R	46	GP450SU	50	GP545R	22		
GP380R	46	GP452SU	50	GP550R	24		
GP382R	46	GP453SU	50	GP551R	23		
GP384R	46	GP454SU	50	GP552R	23		

AESCALAP® BURRS & BLADES

INDEX, UNIVERSAL TOOL ATTACHMENTS, SIGNS AND SYMBOLS

Index, Universelle Werkzeuganschlüsse, Zeichenerklärung

Sommaire, Raccords d'outil universels, Explication des symboles

Índice, Conexiones universales para útiles, Explicación de los símbolos

Indice, Attacchi utensili universali, Spiegazione dei simboli

UNIVERSAL TOOL ATTACHMENTS – UNIVERSELLE WERKZEUGANSCHLÜSSE – RACCORDS D'OUTIL UNIVERSELS – CONEXIONES UNIVERSALES PARA ÚTILES – ATTACCHI UTENSILI UNIVERSALI

AO LARGE

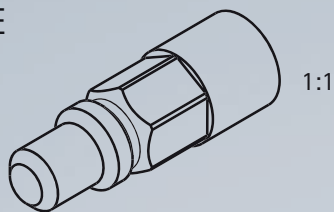

AO SMALL

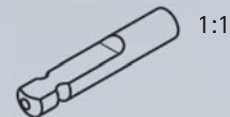

DENTAL

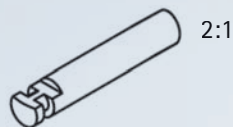

DIN

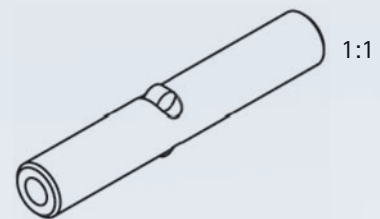

HARRIS

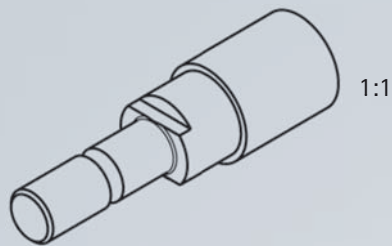

HUDSON

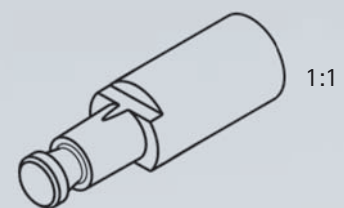

HEXAGON

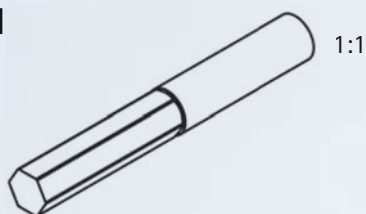

SYNTHES
DHS/DCS

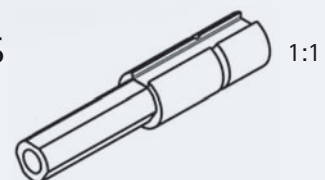

TRINKLE

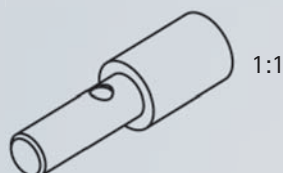

ZIMMER

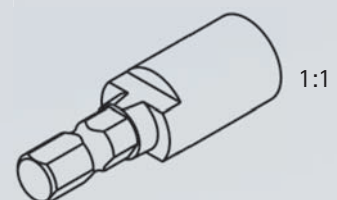

SIGNS AND SYMBOLS – ZEICHENERKLÄRUNG – EXPLICATION DES SYMBOLES – EXPLICACIÓN DE LOS SIMBOLOS – SPIEGAZIONE DEI SIMBOLI



› USEABLE WORKING SURFACE (E. G. OF SAWBLADES), IF NOT OTHERWISE INDICATED BY ACCOMPANYING ILLUSTRATION

Nutzlänge (z. B. bei Sägeblättern), wenn nicht per Skizze anders angegeben
Longueur utile (p. ex. pour les lames de scie), sauf spécification contraire sur schéma
Longitud útil (p.ej.: de las hojas de sierra), si no se indican otros datos en el croquis
Lunghezza utile (ad es. per le lame da sega) se non diversamente indicato nel diagramma



› BURR/BLADE LENGTH

Länge des Werkzeugs – Longueur de l'outil – Longitud de la herramienta – Lunghezza dell'utensile



› BURR/BLADE WIDTH

Breite des Werkzeugs – Largeur de l'outil – Ancho de la herramienta – Larghezza dell'utensile



› BURR/BLADE THICKNESS

Dicke des Werkzeugs – Épaisseur de l'outil – Espesor de la herramienta – Spessore dell'utensile



› INCISION WIDTH: DIFFERENT FROM BLADE THICKNESS IN SAWBLADES WITH OFF-SET

Schnittspalt: weicht bei geschränkten Sägeblättern von der Dicke des Blattes ab
Jeu de coupe: pour les lames de scie croisées, diffère de l'épaisseur de lame
Ancho de corte: en las hojas de sierra triscadas difiere del espesor de la hoja
Fessura di taglio: per le lame allicciate è diversa dallo spessore della lama



› INCISION DEPTH

Schnitttiefe – Profondeur de coupe – Profundidad de corte – Profondità di taglio



› DIAMETER OF BURR

Durchmesser des Werkzeugs – Diamètre de l'outil – Diámetro de la herramienta – Diametro dell'utensile

AESCULAP® BURRS & BLADES

INDEX, UNIVERSAL TOOL ATTACHMENTS, SIGNS AND SYMBOLS

Index, Universelle Werkzeuganschlüsse, Zeichenerklärung

Sommaire, Raccords d'outil universels, Explication des symboles

Índice, Conexiones universales para útiles, Explicación de los símbolos

Indice, Attacchi utensili universali, Spiegazione dei simboli

SIGNS AND SYMBOLS – ZEICHENERKLÄRUNG – EXPLICATION DES SYMBOLES – EXPLICACIÓN DE LOS SIMBOLOS – SPIEGAZIONE DEI SIMBOLI

TC

› TUNGSTEN CARBIDE BURR

Hartmetallfräser – Mèche carbure – Broca de carburo sinterizado – Perforatore in carburo di tungsteno



› PACKAGING UNIT

Verpackungseinheit – Unité de conditionnement – Unidad de embalaje – Unità di confezionamento



› PACKED STERILE / UNSTERILE

Sterile/unsterile Verpackung – Emballage stérile/non stérile – Embalaje estéril/no estéril –
Confezione sterile/non sterile



› TOOL FOR SINGLE USE

Werkzeug zum Einmalgebrauch – Outil pour usage unique – Herramienta de un solo uso –
Utensile monouso



› FOR USE WITH HANDPIECE

Zur Verwendung mit Handstück – A utiliser avec la pièce à main – Utilizar con empuñadura –
Da usarsi con il manipolo



› PAGE

Seite – Page – Pagina – Pagina

NOTICES

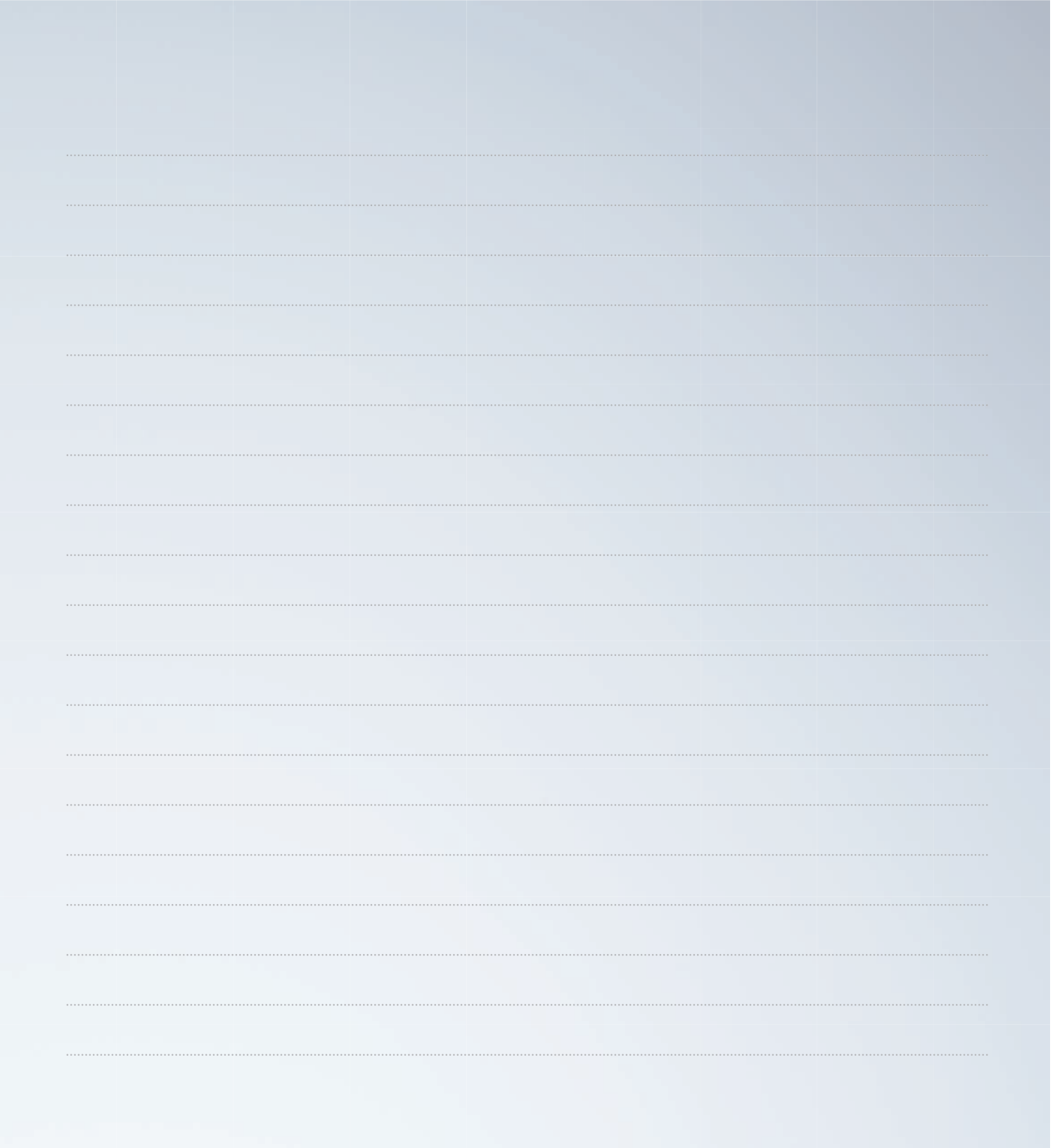

A large rectangular area with a light blue background, overlaid with a faint grey grid. Numerous horizontal dotted lines are spaced evenly down the page, providing a guide for writing. This section is intended for notices.



AESCULAP[®] – a B. Braun brand

Aesculap AG | Am Aesculap-Platz | 78532 Tuttlingen | Germany
Phone +49 7461 95-0 | Fax +49 7461 95-2600 | www.aesculap.com

The main product trademark "Aesculap" is a registered trademark of Aesculap AG.

Subject to technical changes. All rights reserved. This brochure may only be used for the exclusive purpose of obtaining information about our products. Reproduction in any form partial or otherwise is not permitted.