



Hygiene · Aufbereitung

Hygiene ·

Instrument Reprocessing

Hygiene · Instrument Reprocessing

Hygiene · Aufbereitung

1	<i>Machine Reprocessing / Sterilization</i>	Maschinelle Aufbereitung / Sterilisation
2	<i>Manual Reprocessing / RIWO-BOX</i>	Manuelle Aufbereitung / RIWO-BOX
3	<i>Reprocessing Accessories</i>	Aufbereitungs-Zubehör
4	<i>Detergents and Cleaning Agents</i>	Reinigungs- und Pflegemittel
5	<i>Replacement Stopcocks</i>	Ersatz-Hahnküken
6	<i>Accessories / Rubber Seals</i>	Zubehör / Gummidichtungen
7	<i>Hand Blower for air insufflation</i>	Handgebläse zur Luftinsufflation

*Reprocessing Basket
for Laser Fibers
Machine Reprocessing - Sterilization*

*Aufbereitungskorb
für Laserfasern
Maschinelle Aufbereitung - Sterilisation*

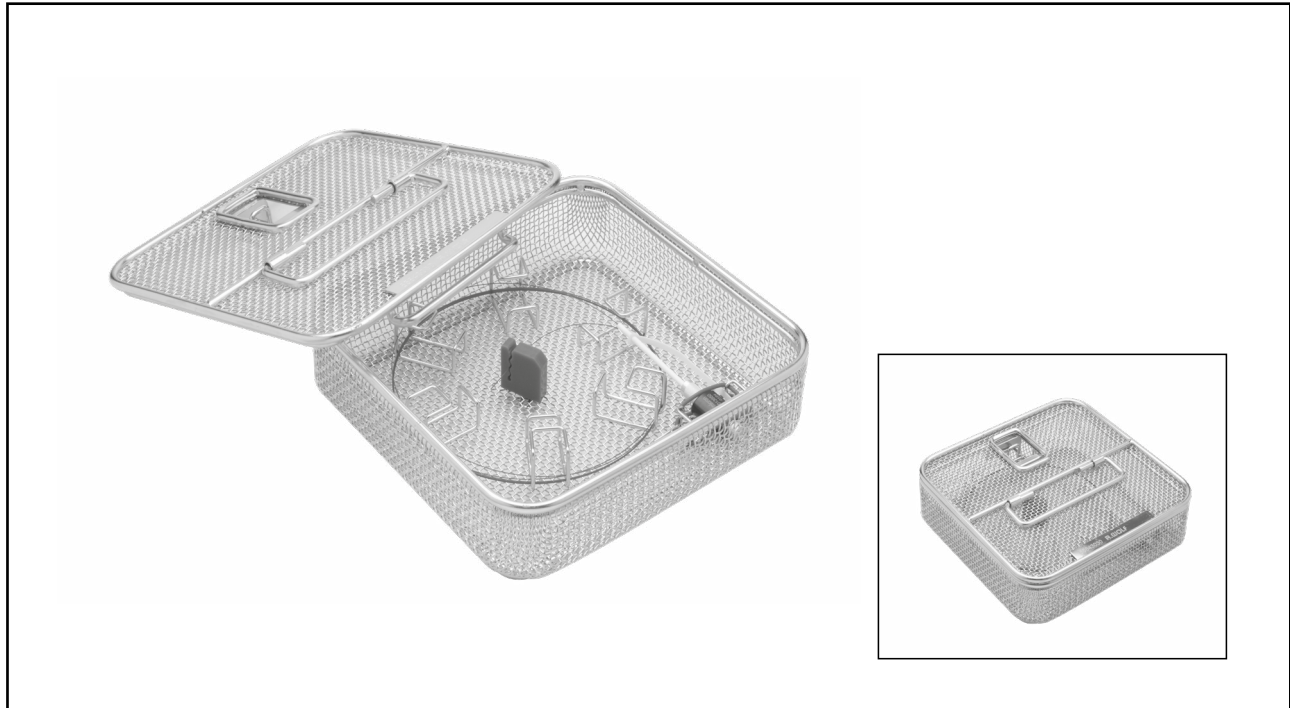

1

	Breite / Width mm	Gesamthöhe / Total height mm	Tiefe / Depth mm	Type / Type
Aufbereitungskorb Laserfasern Aufnahmekapazität: 1 Laser Reprocessing basket laser fibers Capacity: 1 laser	245	68	240	85843030

also:
Silicone holder set 643301190
Spare O-Ring set
 PACK=5 PCS 643301262

hierzu:
Silikonaufnahme-Set 643301190
Ersatz O-Ring-Set,
 VE=5 ST 643301262

**Reprocessing Basket
for Camera Head**
Machine Reprocessing - Sterilization

**Aufbereitungskorb
für Kamerakopf**
Maschinelle Aufbereitung - Sterilisation

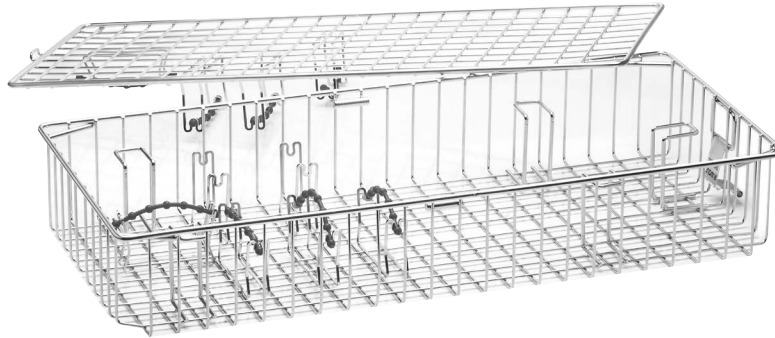

1-Chip HD-Kamerakopf
1-chip HD camera head

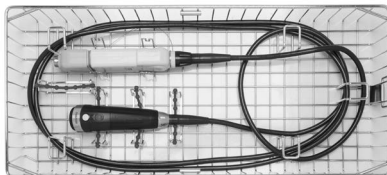

Pendual HD-Kamerakopf - gerade
Pendual HD camera head - straight

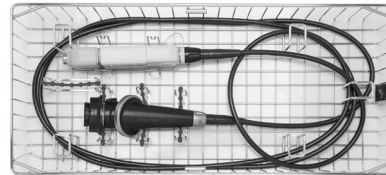

3-Chip HD-Kamerakopf
3-chip HD camera head



Pendual HD-Kamerakopf - abgewinkelt
Pendual HD camera head - angled

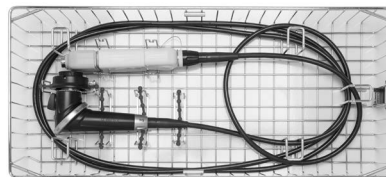

	passend für suitable for	Breite / Width mm	Gesamthöhe / Total height mm	Tiefe / Depth mm	Type / Type
Aufbereitungskorb Kamerakopf Reprocessing basket camera head	85525902 85525922 85525923 85525942 5525933 5525833 5514901 5514961 5521902	445	73	200	38047111

also:

Silicone chain set

consisting of: Silicone chain

1x 6 beads, 6x 7 beads, 1x 8 beads 643301174

hierzu:

Silikon-Kette Set

bestehend aus: Silikonkette

1x 6-fach, 6x 7-fach, 1x 8-fach 643301174

*Reprocessing Basket
for URS, Nephroscope and
US-Transducer
Machine Reprocessing - Sterilization*

**Aufbereitungskorb
für URS, Nephroskop und
US-Transducer
Maschinelle Aufbereitung - Sterilisation**

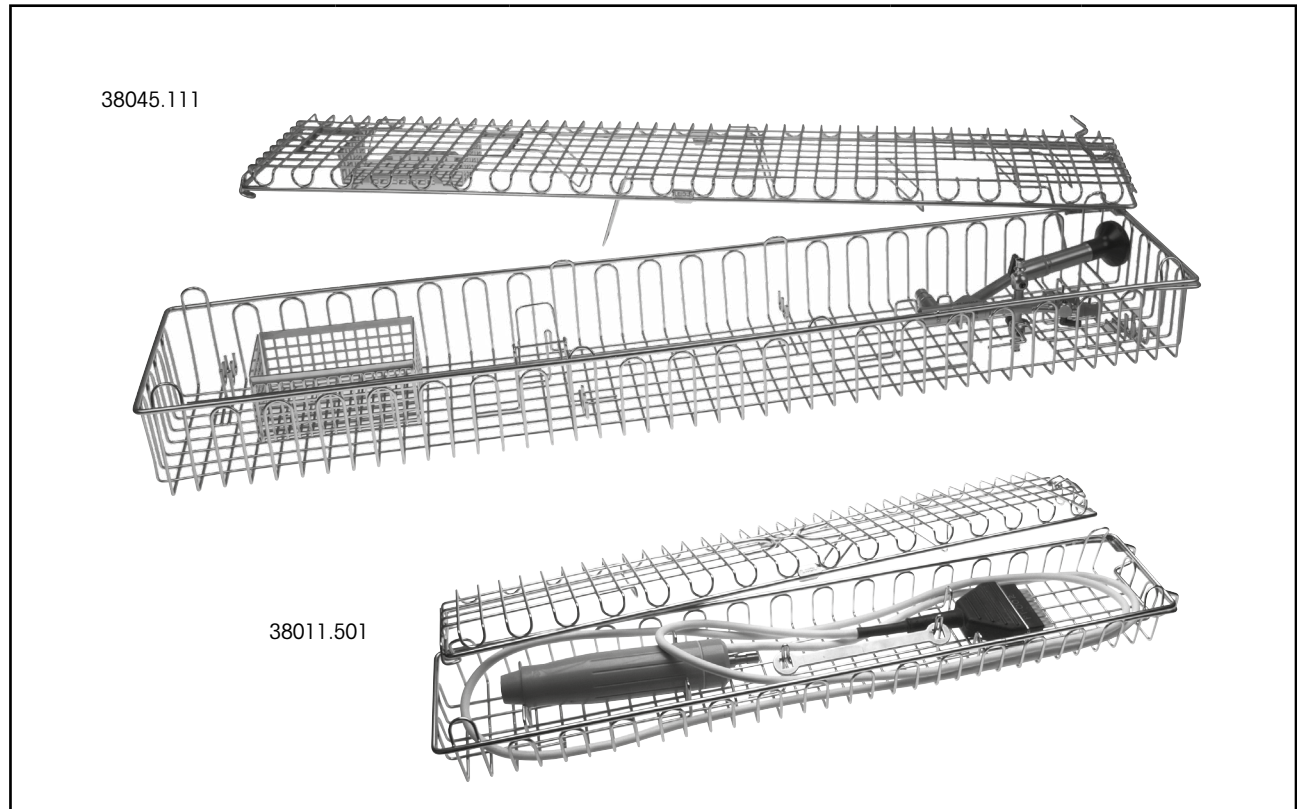

	passend für <i>suitable for</i>	Breite / <i>Width</i> mm	Gesamthöhe / <i>Total height</i> mm	Tiefe / <i>Depth</i> mm	Type / <i>Type</i>
Aufbereitungskorb URS mit zusätzlichen Halterungen für Sonotroden Reprocessing basket URS <i>with additional mountings for sonotrodes</i>	URS / <i>URS</i> : 8701.xxx 8702.xxx 8703.xxx 8704.xxx 8708.xxx Nephroskop: <i>Nephroscope</i> : 8968.421	640	74	132	38045.111*
Aufbereitungskorb US-Transducer inkl. Ringschlüssel (64262.012) Reprocessing basket US-transducer <i>incl. ring key (64262.012)</i>	US-Transducer: <i>US-transducer</i> : 2271.501	450	46	80	38011.501

* also:

Tube set

for instrument connection

(8702.514/8703.514) 38040.901

* hierzu:

Schlauchset

zum Instrumenten-Anschluss

(8702.514/8703.514) 38040.901

*Reprocessing Basket
for Cystoscope
Machine Reprocessing - Sterilization*

**Aufbereitungskorb
für Cystoskop
Maschinelle Aufbereitung - Sterilisation**

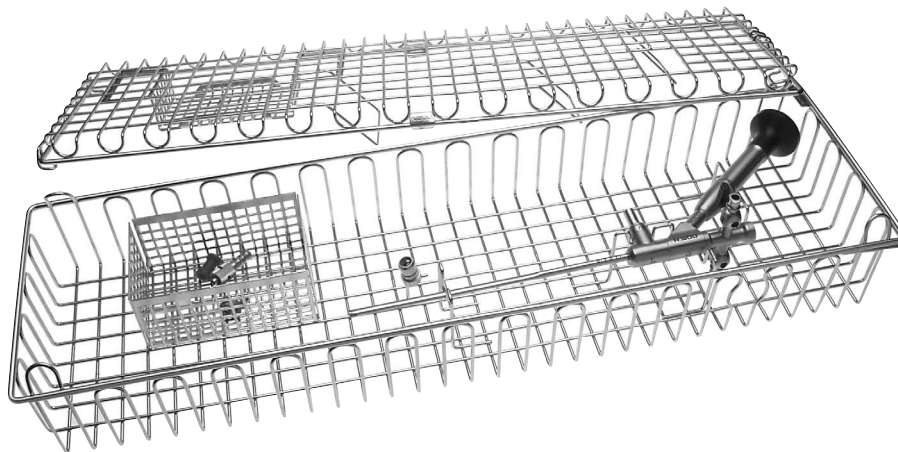

	passend für <i>suitable for</i>	Breite / <i>Width</i> mm	Gesamthöhe / <i>Total height</i> mm	Tiefe / <i>Depth</i> mm	Type / <i>Type</i>
Aufbereitungskorb Cystoskop <i>Reprocessing basket cystoscope</i>	Cystoskop: <i>Cystoscope:</i> 8626.531 OP-Optik: <i>OP telescope:</i> 8632.411 8643.401 8746.401	472	74	132	38044.611

*Reprocessing Basket
for Discoscope
Machine Reprocessing - Sterilization*

**Aufbereitungskorb
für Diskoskop
Maschinelle Aufbereitung - Sterilisation**

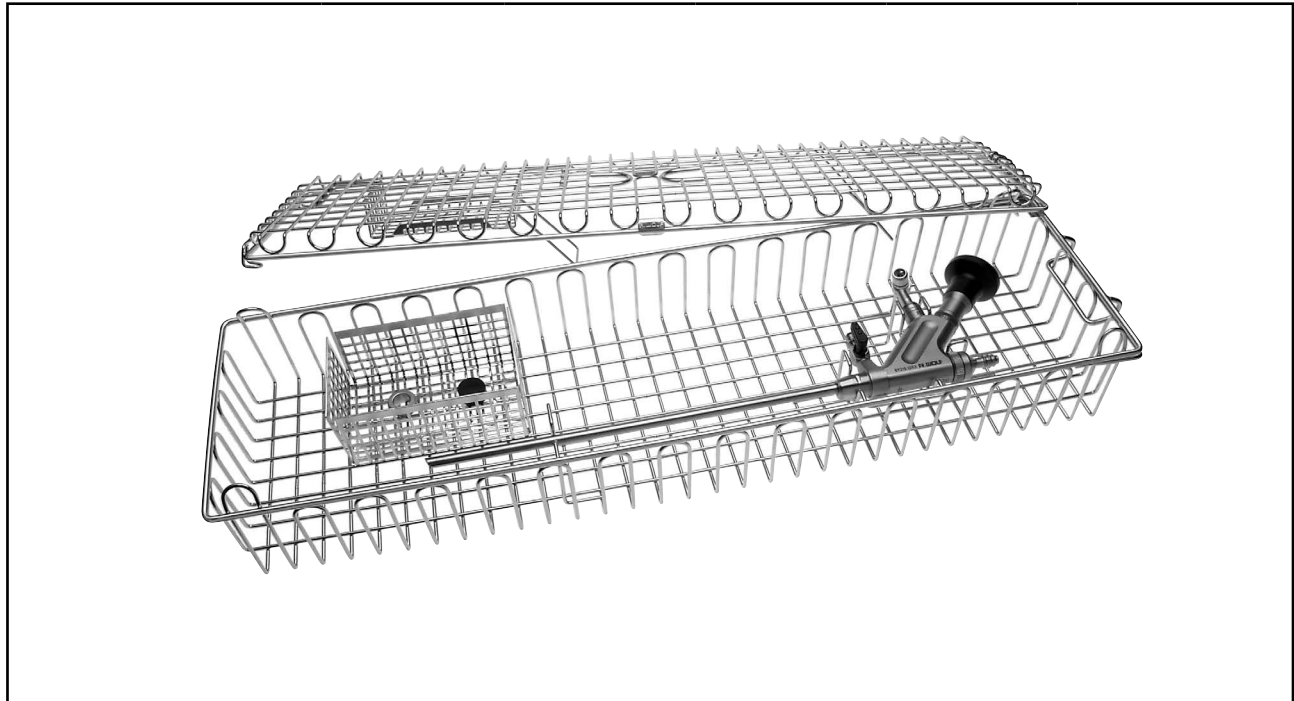

	passend für <i>suitable for</i>	Breite / <i>Width</i> mm	Gesamthöhe / <i>Total height</i> mm	Tiefe / <i>Depth</i> mm	Type / <i>Type</i>
Aufbereitungskorb Diskoskop <i>Reprocessing basket discoscope</i>	Discoskop: Discoscope: 89210.1253 89210.1254 89210.3253 89210.3254	472	74	132	38044.411

**Reprocessing Basket
for Telescope**
Machine Reprocessing - Sterilization

**Aufbereitungskorb
für Optik**
Maschinelle Aufbereitung - Sterilisation

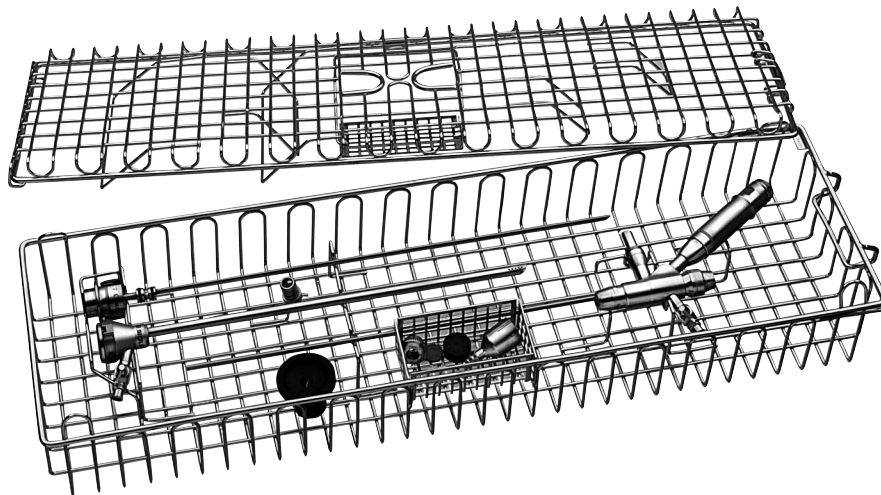

	passend für suitable for	Breite / Width mm	Gesamthöhe / Total height mm	Tiefe / Depth mm	Type / Type
Aufbereitungskorb Optik mit Aufnahme für Wechselschäfte Reprocessing basket telescope with mounting for exchangeable sheaths	PANOVIEW-Optik: PANOVIEW telescope: 8753.411	472	74	132	38044.311

also:
Irrigation adapter 64164.033

hierzu:
Spüladapter 64164.033

*Reprocessing Basket
for Video-Mediastinoscope
Machine Reprocessing - Sterilization*

*Aufbereitungskorb
für Video-Mediastinoskop
Maschinelle Aufbereitung - Sterilisation*

1

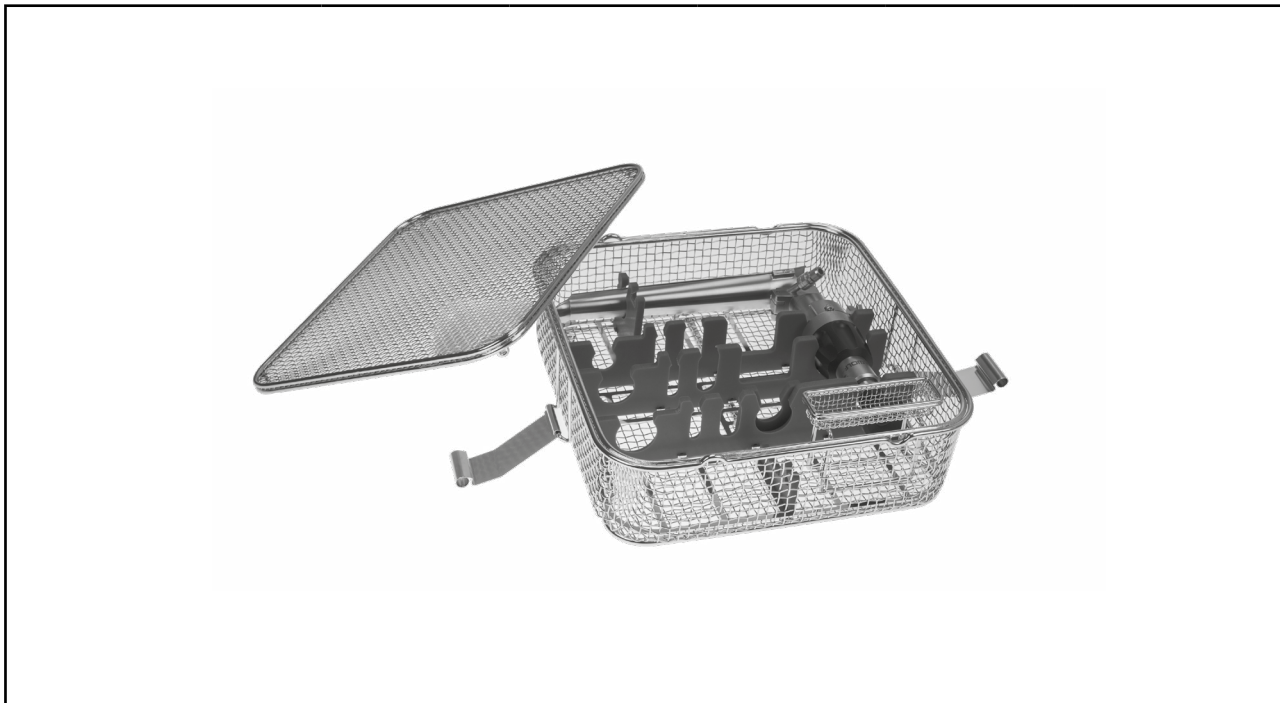

	passend für <i>suitable for</i>	Breite / <i>Width</i> mm	Gesamthöhe / <i>Total height</i> mm	Tiefe / <i>Depth</i> mm	Type / <i>Type</i>
Aufbereitungskorb Video-Mediastinoskop Reprocessing basket video-mediastinoscope	Video- Mediastinoskop: Video- mediastinoscope: 8783.412 8784.411	250	72	240	38044240

also:
Silicone holder set 643301197

hierzu:
Silikonaufnahme-Set 643301197

*Reprocessing Basket
for OP-Telescope
Machine Reprocessing - Sterilization*

**Aufbereitungskorb
für OP-Optik
Maschinelle Aufbereitung - Sterilisation**

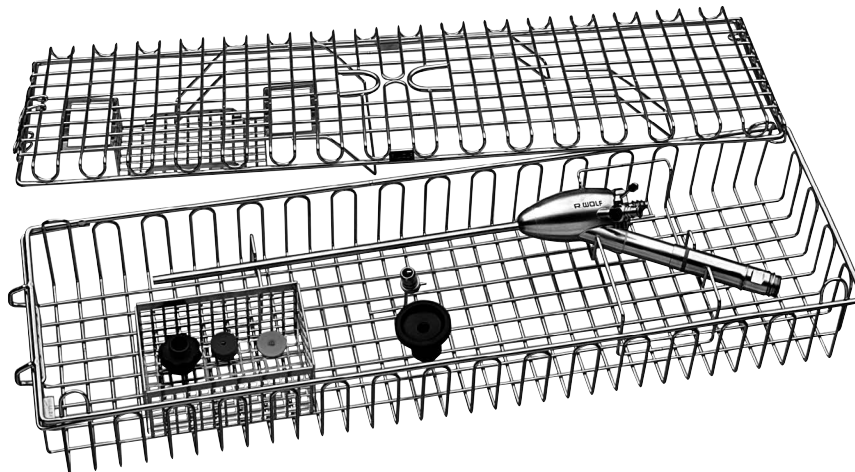

	passend für <i>suitable for</i>	Breite / Width mm	Gesamthöhe / <i>Total height</i> mm	Tiefe / Depth mm	Type / Type
Aufbereitungskorb OP-Optik <i>Reprocessing basket OP-Telescope</i>	OP-Optik: OP-Telescope: 8920.4011	472	74	132	38044.211

also:
Irrigation adapter 64164.031

hierzu:
Spüladapter 64164.031

*Reprocessing Basket
for Hysteroscope
Machine Reprocessing - Sterilization*

**Aufbereitungskorb
für Hysteroskop
Maschinelle Aufbereitung - Sterilisation**

1

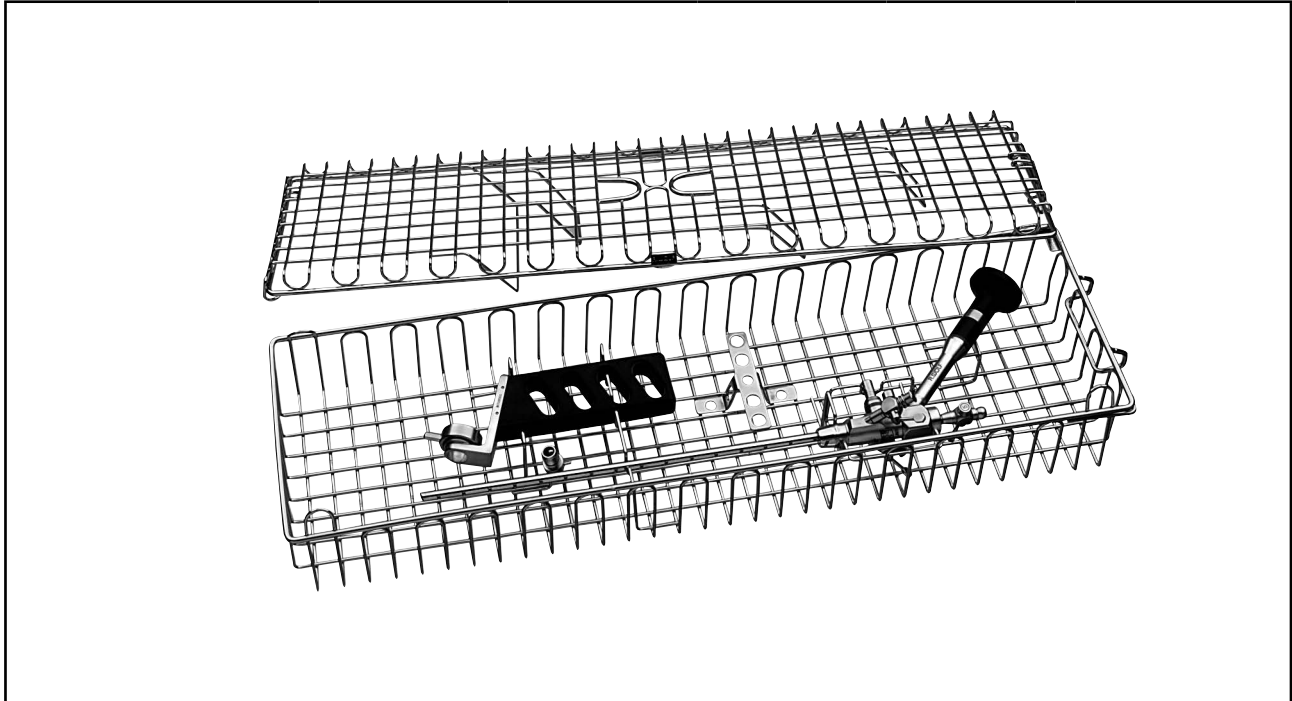

	passend für <i>suitable for</i>	Breite / <i>Width</i> mm	Gesamthöhe / <i>Total height</i> mm	Tiefe / <i>Depth</i> mm	Type / <i>Type</i>
Aufbereitungskorb Hysteroskop Reprocessing basket hysteroscope	Hysteroskop: <i>Hysteroscope:</i> 8986.401 8977.411 8793.401 8792.401 8792.411 8767.412	472	89	132	38044.111

also:
Irrigation adapter 64164.039

hierzu:
Spüladapter 64164.039

*Reprocessing Basket
for Stereo-Telescope
Machine Reprocessing - Sterilization*

**Aufbereitungskorb
für Stereo-Optik
Maschinelle Aufbereitung - Sterilisation**

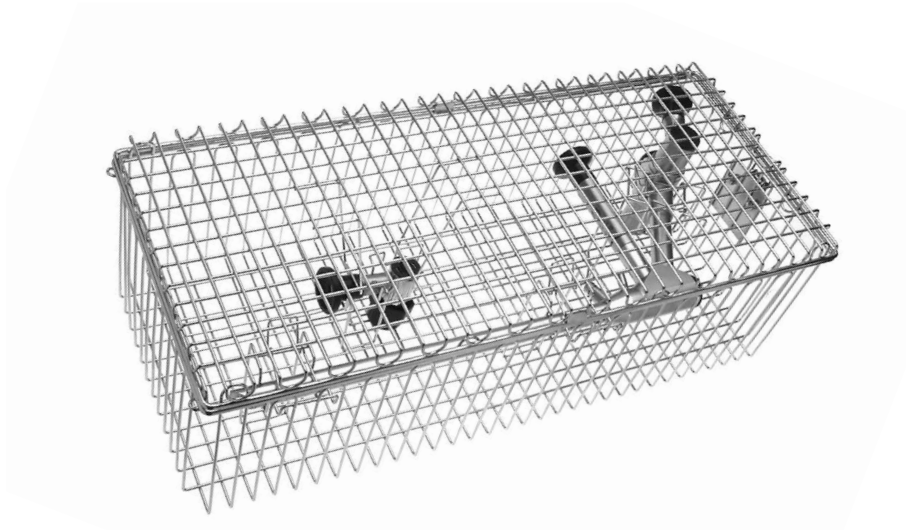

	passend für <i>suitable for</i>	Breite / <i>Width</i> mm	Höhe / <i>Height</i> mm	Tiefe / <i>Depth</i> mm	Type / <i>Type</i>
Aufbereitungskorb Stereo-Optik <i>Reprocessing baskets stereo-telescope</i>	Stereo-Optik: <i>Stereo-telescope:</i> 8840.402 884080	479	139	196	38043012

*Reprocessing Basket
for Nephroscope
Machine Reprocessing - Sterilization*

**Aufbereitungskorb
für Nephroskop
Maschinelle Aufbereitung - Sterilisation**

1

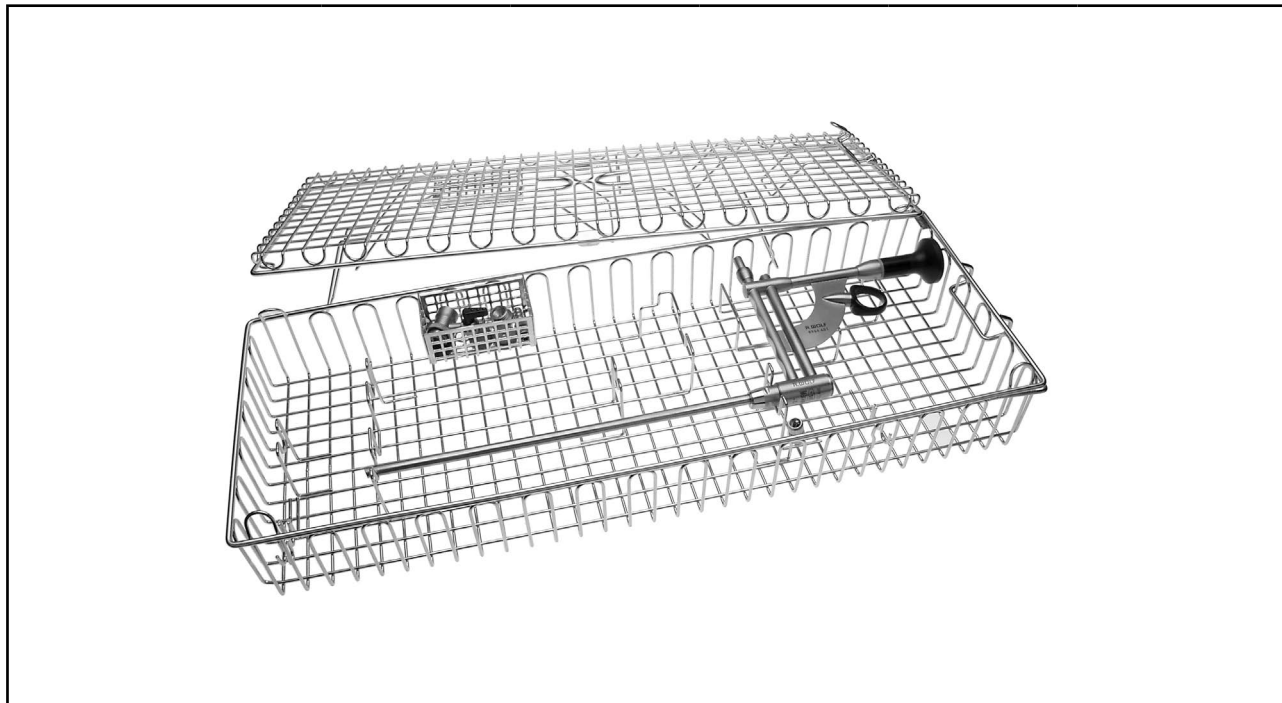

	passend für <i>suitable for</i>	Breite / <i>Width</i> mm	Gesamthöhe / <i>Total height</i> mm	Tiefe / <i>Depth</i> mm	Type / <i>Type</i>
Aufbereitungskorb Nephroskop <i>Reprocessing basket nephroscope</i>	Nephroskop: <i>Nephroscope:</i> 8964.401 8965.401 8965.411 8966.401	458	73	172	38042.311

also:
Irrigation adapter
(8964.401/8965.401/8965.411) 64164.038
(8966.401)..... 64164.031

hierzu:
Spüladapter
(8964.401/8965.401/8965.411) 64164.038
(8966.401)..... 64164.031

*Reprocessing Basket
for Morescope
Machine Reprocessing - Sterilization*

**Aufbereitungskorb
für Morescope
Maschinelle Aufbereitung - Sterilisation**

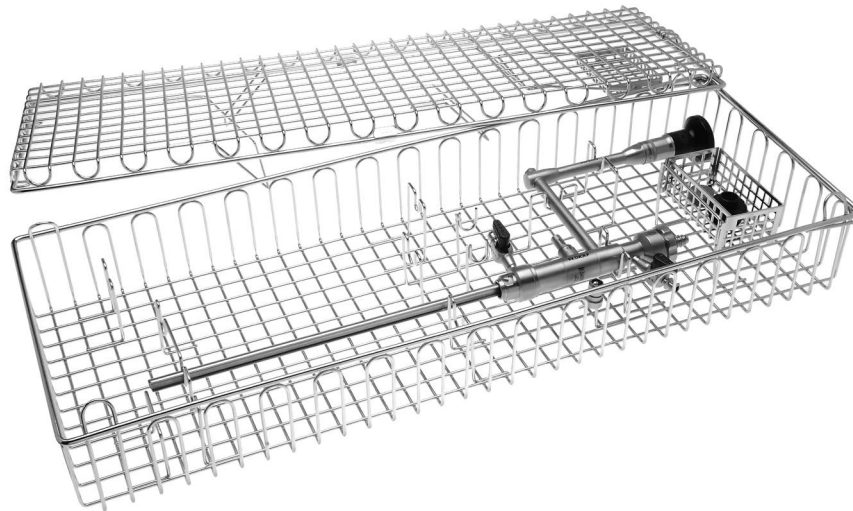

	passend für <i>suitable for</i>	Breite / <i>Width</i> mm	Gesamthöhe / <i>Total height</i> mm	Tiefe / <i>Depth</i> mm	Type / <i>Type</i>
Aufbereitungskorb Morescope <i>Reprocessing basket Morescope</i>	Morescope: 8970.401 8970402 8970403 8970405 8970407	458	73	172	38042.211

*Reprocessing Basket
for Cysto-Urethroscope
Machine Reprocessing - Sterilization*

**Aufbereitungskorb
für Cysto-Urethroskop
Maschinelle Aufbereitung - Sterilisation**

1

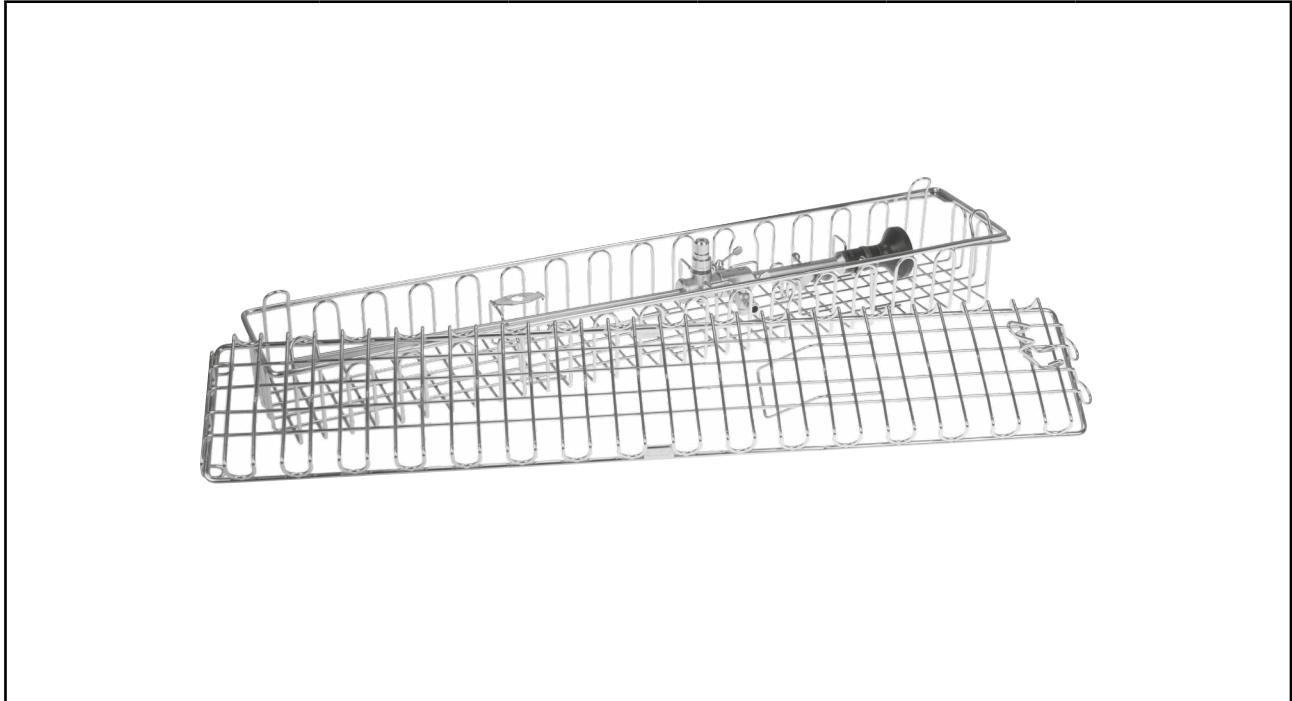

	passend für <i>suitable for</i>	Breite / <i>Width</i> mm	Gesamthöhe / <i>Total height</i> mm	Tiefe / <i>Depth</i> mm	Type / <i>Type</i>
Aufbereitungskorb Cysto-Urethroskop <i>Reprocessing basket cysto-urethroscope</i>	Kompakt-Cysto- Urethroskop: Compact cysto- urethroscope: 8642.403 8645.403	450	62	80	38039.011

also:
Tube set 38039.901

hierzu:
Schlauchset 38039.901

**Reprocessing Basket
for 3DHD Telescope**
Machine Reprocessing - Sterilization

**Aufbereitungskorb
für 3DHD Optik**
Maschinelle Aufbereitung - Sterilisation

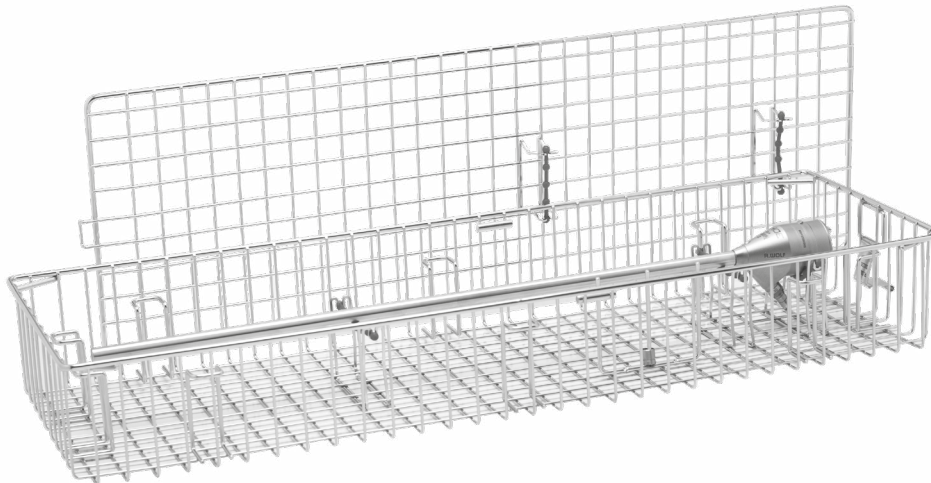

	passend für suitable for	Breite / Width mm	Gesamthöhe / Total height mm	Tiefe / Depth mm	Type / Type
Aufbereitungskorb 3DHD Optik Reprocessing basket 3DHD telescope	3DHD Optik: 3DHD telescope: 89346311 893446311 89346321 893446321	583	80	200	38023111

also:
Silicone chain set
 consisting of: Silicone chain 1x 5 beads, 1x 6 beads,
 2x 7 beads, 1x 8 beads 643301187

hierzu:
Silikon-Kette Set
 bestehend aus: Silikon-Kette 1x 5-fach, 1x 6-fach,
 2x 7-fach, 1x 8-fach 643301187

*Reprocessing Basket
for Standard Telescope
Machine Reprocessing - Sterilization*

*Aufbereitungskorb
für Standard-Optik
Maschinelle Aufbereitung - Sterilisation*

1

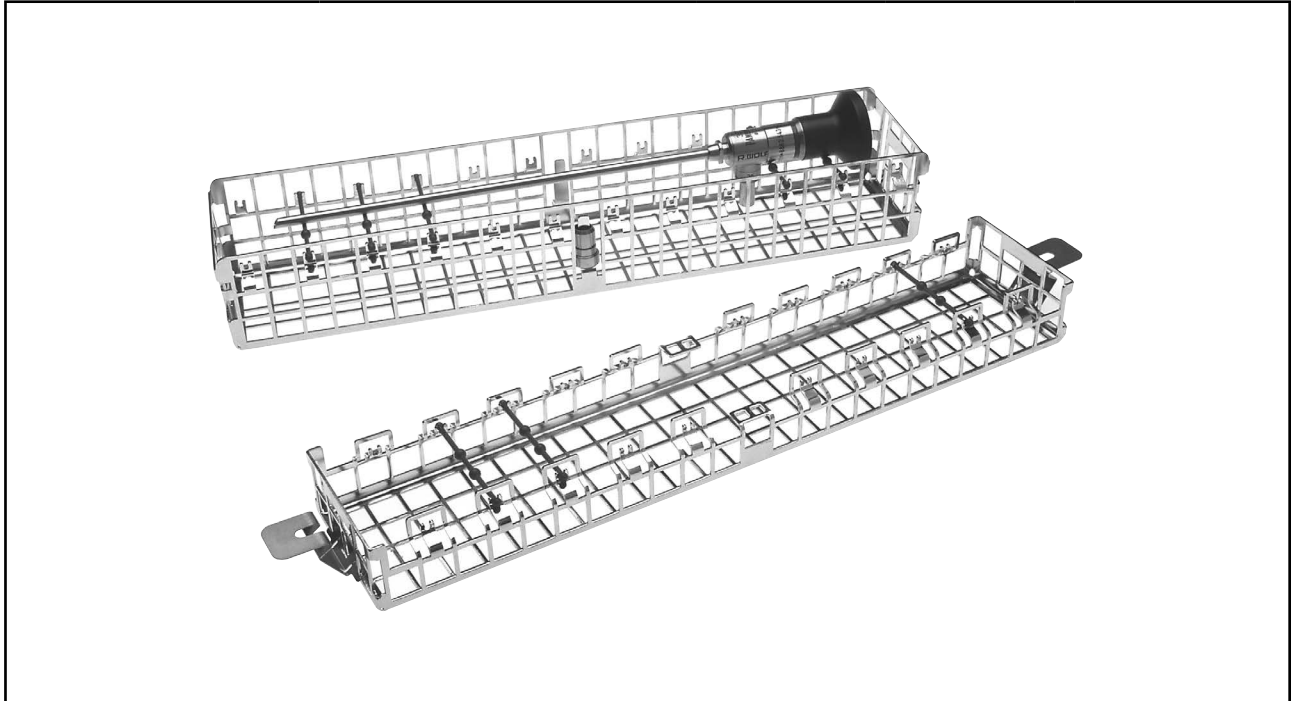

	Breite / Width mm	Höhe / Height mm	Tiefe / Depth mm	Gewicht / Weight g	Type / Type
Aufbereitungskorb für alle endoskopischen Optiken Aufnahmekapazität: 1 Optik Reprocessing basket for all endoscopic telescopes Capacity: 1 telescope	287	54	59	255	38020.111
	471			355	38021.111
	610			410	38022.111

also:

Ball chain

PACK=20 PCS 38015.001

hierzu:

Kugel-Kette

VE=20 ST 38015.001

Sterilization Basket System

Sterilisations-Siebkorbsystem

1

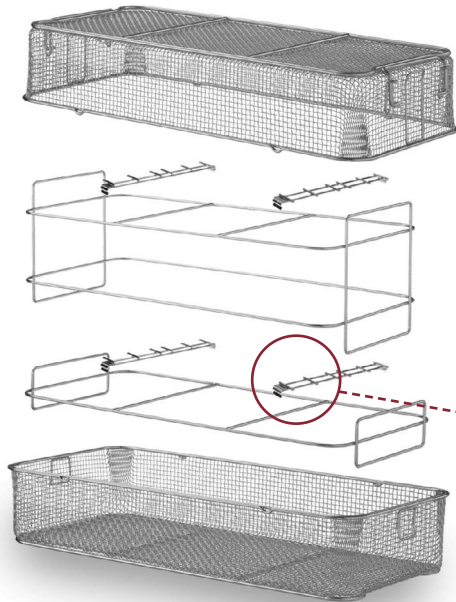

Das RICHARD WOLF Siebkorbsystem, universell verwendbar, dient der sicheren und schonenden Aufnahme des wertvollen Instrumentariums während

- der Sterilisation
- des Transportes
- der Lagerung

Durch das universelle Siebkonzept lässt sich fast jede Siebkonfiguration zusammenstellen.

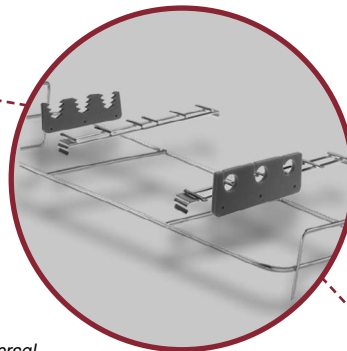

RICHARD WOLF's open mesh basket system, which has universal application, holds even the most expensive instruments safely and carefully during

- sterilization
- transport
- storage

The universal basket concept allows almost any basket configuration to be set up.

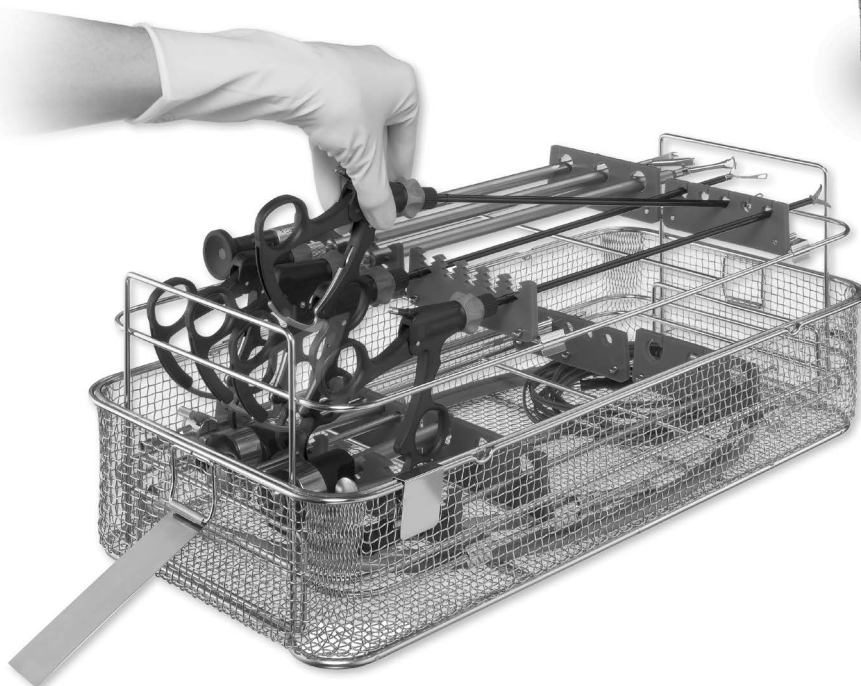
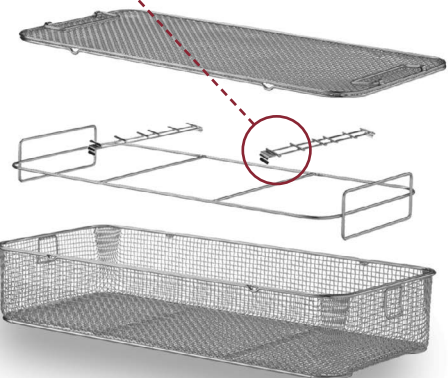

Sterilization Basket System

Sterilisations-Siebkorbsystem

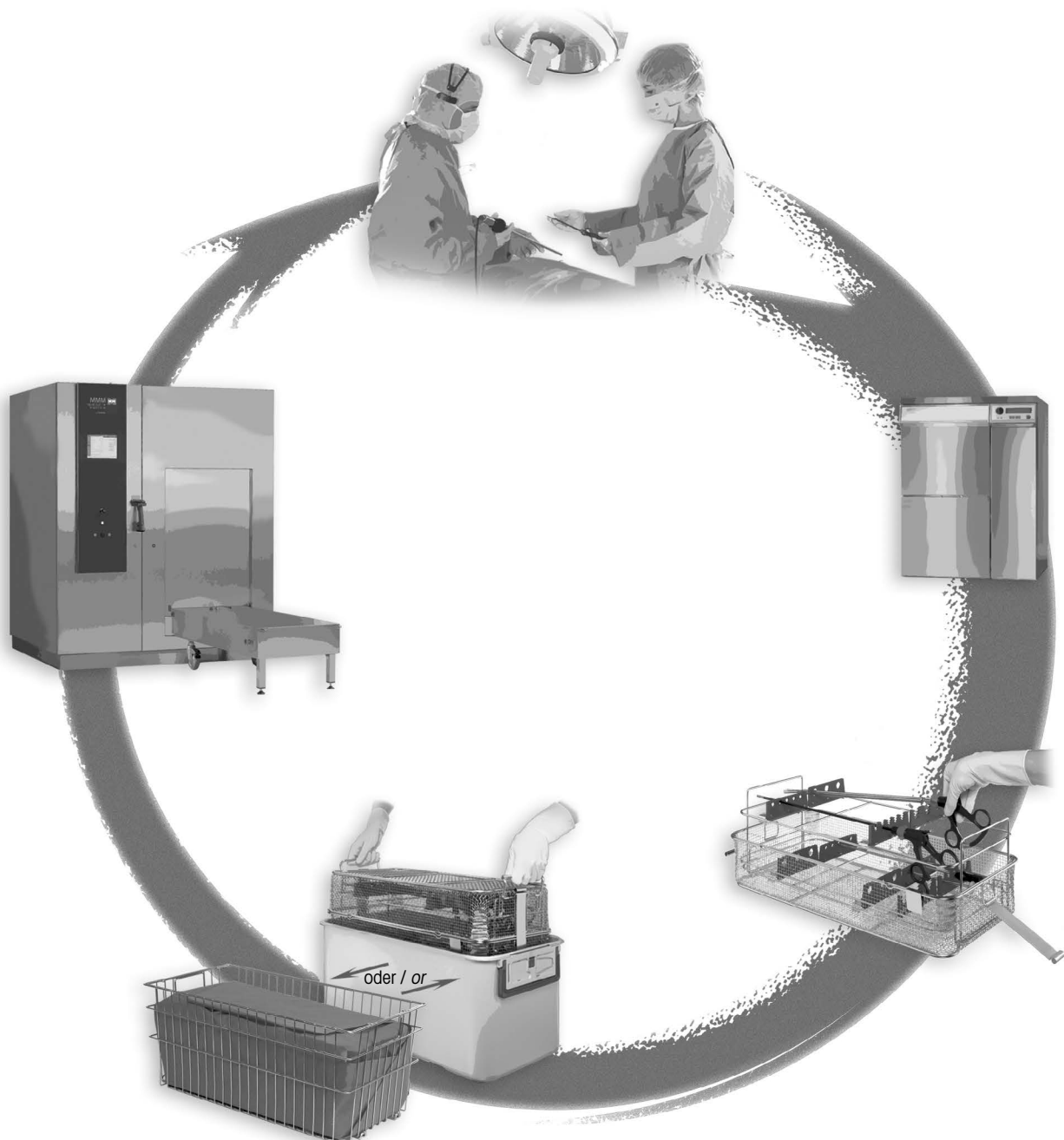

Sterilization Basket

low

Sterilization - Storage - Transport

Sterilisationskorb

niedrig

Sterilisation - Lagerung - Transport

1

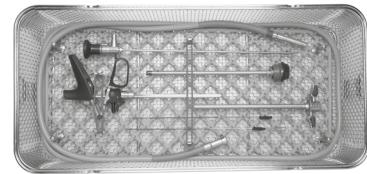
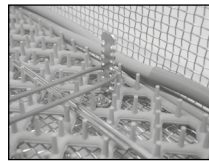
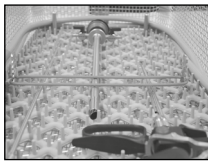
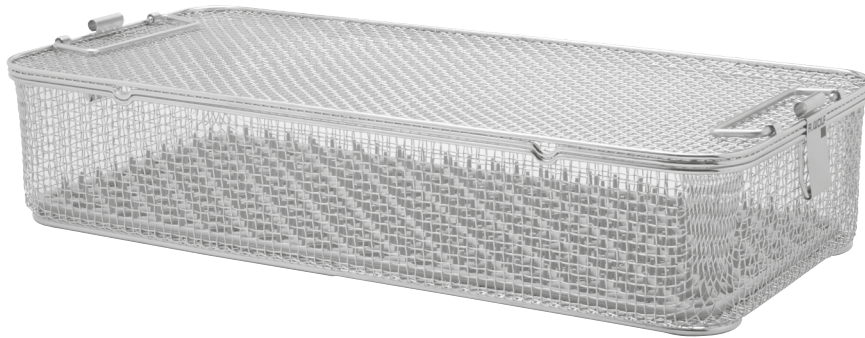

Beispiel für Lagerung
Example for storage

	Breite / Width mm	Gesamthöhe / Total height mm	Tiefe / Depth mm	Type / Type
<p>Sterilisationskorb, niedrig bestehend aus: Siebkorbunterteil, Siebkorbdeckel flach mit Federverschluss und 2 Griffen und Silikonmatte "Large Diamond"</p> <p>Sterilization basket, low consisting of: basket lower part, basket lid flat with spring lock and 2 handles and Silicone mat "Large Diamond"</p>	530	108	250	85844001

suitable for standard container

passend für Standard Container (1 STE = 1 Sterilguteinheit)

Accessories see page J 23-J 24.

Zubehör siehe Seite J 23-J 24.

Sterilization Basket

low - long

Sterilization - Storage - Transport

Sterilisationskorb

niedrig - lang

Sterilisation - Lagerung - Transport

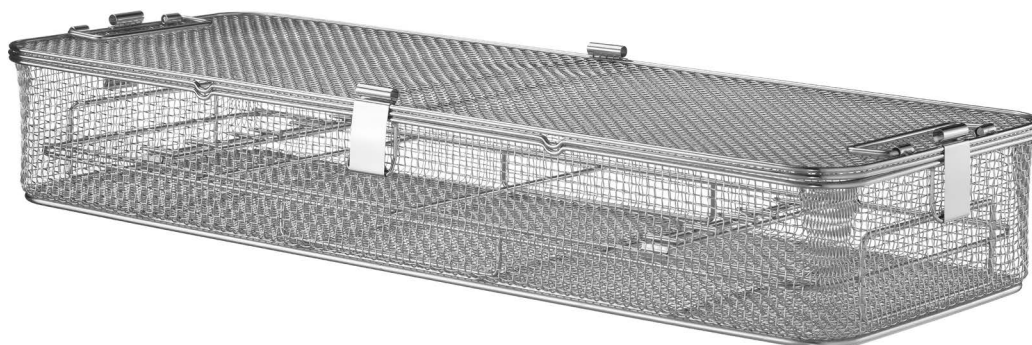

	Breite / Width mm	Gesamthöhe / Total height mm	Tiefe / Depth mm	Type / Type
<p>Sterilisationskorb, niedrig - lang bestehend aus: Siebkorbunterteil, Instrumentträger niedrig, 2 Aufnahmesteg, Siebkorbdeckel flach mit Federverschluss und 2 Griffen</p> <p>Sterilization basket, low - long consisting of: basket lower part, instrument rack flat, 2 support bars, basket lid high with spring lock and 2 handles</p>	725	108	275	8584.1312

Extra-long e.g. for bronchoscopy, urology (upper urinary tract)

Überlänge z.B. für Bronchoskopie, Urologie (oberer Harntrakt)

Accessories see page J 23-J 24.

Zubehör siehe Seite J 23-J 24.

Sterilization Basket
high - long
Sterilization - Storage - Transport

Sterilisationskorb
hoch - lang
Sterilisation - Lagerung - Transport

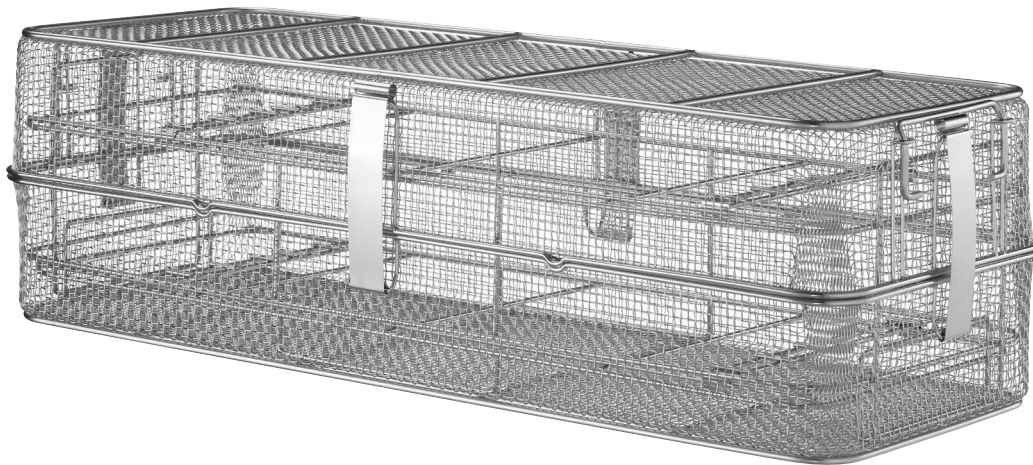

	Breite / Width mm	Gesamthöhe / Total height mm	Tiefe / Depth mm	Type / Type
<p>Sterilisationskorb, hoch - lang bestehend aus: Siebkorbunterteil, Instrumententräger niedrig, 4 Aufnahmesteg, Siebkorbdeckel hoch mit Federverschluss und 2 Griffen</p> <p>Sterilization basket, high - long consisting of: basket lower part, instrument rack low, 4 support bars, basket lid high with spring lock and 2 handles</p>	725	200	275	8584.1302

Extra-long e.g. for bronchoscopy, urology (upper urinary tract)

Überlänge z.B. für Bronchoskopie, Urologie (oberer Harntrakt)

Accessories see page J 23-J 24.

Zubehör siehe Seite J 23-J 24.

Sterilization Basket

low - standard

Sterilization - Storage - Transport

Sterilisationskorb

niedrig - Standard

Sterilisation - Lagerung - Transport

1

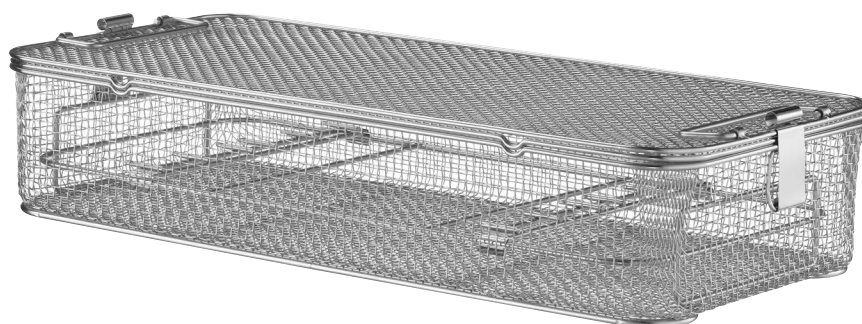

	Breite / Width mm	Gesamthöhe / Total height mm	Tiefe / Depth mm	Réf. / Ref.
<p>Sterilisationskorb, niedrig - Standard bestehend aus: Siebkorbunterteil, Instrumententräger niedrig, 2 Aufnahmesteg, Siebkorbdeckel flach mit Federverschluss und 2 Griffen</p> <p>Sterilization basket, flat - standard consisting of: basket lower part, instrument rack low, 2 support bars, basket lid flat with spring lock and 2 handles</p>	530	108	250	8584.1212

suitable for standard container

passend für Standard Container (1 STE = 1 Sterilguteinheit)

Accessories see page J 23-J 24.

Zubehör siehe Seite J 23-J 24.

Sterilization Basket
high - standard
Sterilization - Storage - Transport

Sterilisationskorb
hoch - Standard
Sterilisation - Lagerung - Transport

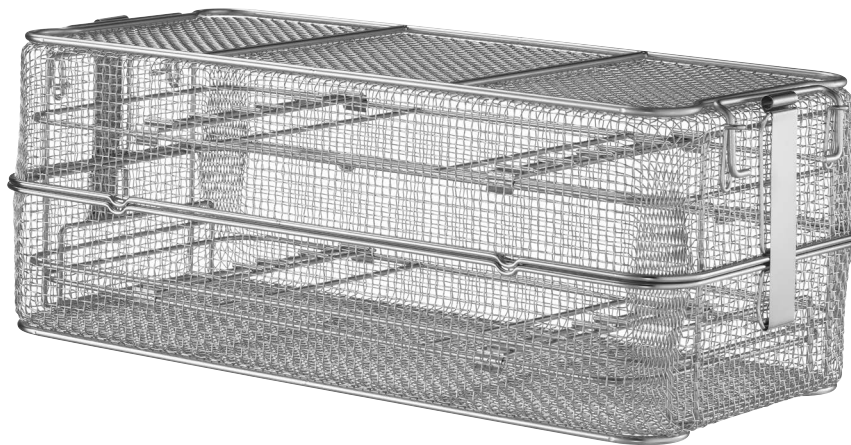

	Breite / Width mm	Gesamthöhe / Total height mm	Tiefe / Depth mm	Type / Type
<p>Sterilisationskorb, hoch - Standard bestehend aus: Siebkorbunterteil, Instrumententräger hoch und niedrig, 4 Aufnahmesteg, Siebkorbdeckel hoch mit Federverschluss und 2 Griffen</p> <p>Sterilization basket, high - standard consisting of: Basket lower part, instrument rack high and low, 4 support bars, basket lid high with spring lock and 2 handles</p>	530	200	250	8584.1202

suitable for standard container

passend für Standard Container (1 STE = 1 Sterilguteinheit)

Accessories see page J 23-J 24.















Zubehör siehe Seite J 23-J 24.

Accessories

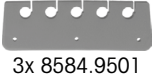
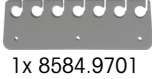
for Sterilization Basket System

Zubehör

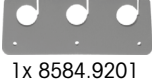

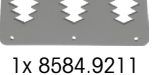
zum Sterilisation-Siebkorbsystem

	Bezeichnung / Article description	Type / Type
	Aufnahmesteg für Silikonaufnahmen, 2-fach Support bar for silicone holder, double	8584.8203
	Silikonaufnahme , geschlossen, 3-fach, für Instrumente von Ø 8 - 14,5 mm Silicone holder , closed, triple, for instruments with Ø 8 to 4.5 mm	8584.9201
	Silikonaufnahme , offen, 3-fach, für Instrumente von Ø 8 - 14,5 mm Silicone holder , open, triple, for instruments with Ø 8 to 14.5 mm	8584.9211
	Silikonaufnahme , geschlossen, 5-fach, für Instrumente von Ø 1 - 7,5 mm Silicone holder , closed, for up to 5 items, for instruments with Ø 1 to 7.5 mm	8584.9501
	Silikonaufnahme , offen, 5-fach, für Instrumente von Ø 1 - 7,5 mm Silicone holder , open, for up to 5 items, for instruments with Ø 1 to 7.5 mm	8584.9511
	Silikonaufnahme , geschlossen, 7-fach, für Instrumente von Ø 1 - 7,5 mm Silicone holder , closed, for up to seven items, for instruments with Ø 1 to 7.5 mm	8584.9701
	Silikonaufnahme , offen, 7-fach für Instrumente von Ø 1 - 7,5 mm Silicone holder , open, for up to seven items, for instruments with Ø 1 to 7.5 mm	8584.9711
	Silikon-Anschlagplatte zur Sicherstellung der axialen Position von Instrumenten mit kleinen Durchmessern, Dim: 109 x 40 x 5 mm Silicon stop plate ensures the axial position of instruments with smaller diameters, Dim: 109 x 40 x 5 mm	85849005
für Urologie / Arthroskopie for Urology / Arthroscopy  3x 8584.9501  1x 8584.9701  3x 8584.9511  1x 8584.9711	Starter Set Silikonaufnahmen bestehend aus: 3x 8584.9501, 3x 8584.9511, 1x 8584.9701, 1x 8584.9711 Starting Set Silicone holder consisting of: 3x 8584.9501, 3x 8584.9511, 1x 8584.9701, 1x 8584.9711	8584.9001
für Laparoskopie / Chirurgie / Gynäkologie for Laparoscopy / Surgery / Gynaecology  3x 8584.9501  1x 8584.9201  3x 8584.9511  1x 8584.9211	Starter Set Silikonaufnahmen bestehend aus: 3x 8584.9501, 3x 8584.9511, 1x 8584.9201, 1x 8584.9211 Starting Set Silicone holder consisting of: 3x 8584.9501, 3x 8584.9511, 1x 8584.9701, 1x 8584.9711	8584.9002

Accessories
for Sterilization Basket System

Zubehör
zum Sterilisation-Siebkorbsystem

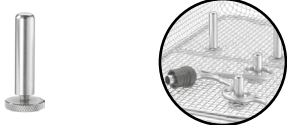
1

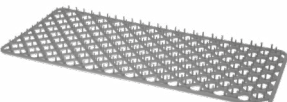
	Bezeichnung / Article description	Type / Type
	<p>System Kleinteilsieb (B x H x T): 121 x 35 x 121 mm System small part basket (w x h x d) 121 x 35 x 121 mm</p>	8584.3003
	<p>Arretierstift, z.B. für die Fixierung von Handgriffen, VE= 2 ST Locking pin, e.g. for fixation of handles, PACK=2 PCS</p>	8584.8205
	<p>Fixierwinkel-Set bestehend aus: O-Ring-Set, 2x Winkel, 1x Sechskant-Stiftschlüssel Set of fixation brackets consisting of: O-ring set, 2x angle bracket, 1x allen wrench</p>	85848210
	<p>O-Ring-Set bestehend aus: 1x O-Ring 90x3 mm, 1x O-Ring 116x3mm O-ring set consisting of: 1x O-ring 90x3 mm, 1x O-ring 116x3</p>	74002311
	<p>Silikonmatte "Large Diamond" (B x H x T) 500 x 18 x 226 mm Silicone mat "Large Diamond" (w x h x d) 500 x 18 x 226 mm</p>	85843010

*Sterilization Basket
for Instruments
Knee Arthroscopy - Basic Set
Sterilization - Storage - Transport*

Sterilisationskorb
für Instrumentarium
Knie-Arthroskopie - Basis-Set
Sterilisation - Lagerung - Transport

1



	Breite / Width mm	Gesamthöhe / Total height mm	Tiefe / Depth mm	Type / Type
<p>Sterilisationskorb Knie-Basis-Set bestehend aus: Siebkorbunterteil, 2 Instrumententräger mit Aufnahme-Einheiten und Silikon- aufnahmen für Instrumenten-Basis-Set "Knie", Siebkorbdeckel mit Federverschluss und 2 Griffen</p> <p>Sterilization basket <i>knee basic set</i> consisting of: Basket lower part, 2 instrument racks with support bars, basket and silicone holders for instrument basic set "Knee", basket lid with spring lock and 2 handles</p>	530	150	250	85841221

suitable for standard container

passend für Standard Container (1 STE = 1 Sterilguteinheit)

**Sterilization Basket
for Instruments**

Knee Arthroscopy - ACL / PCL 1
Sterilization - Storage - Transport

**Sterilisationskorb
für Instrumentarium**

Knie-Arthroskopie - ACL / PCL 1
Sterilisation - Lagerung - Transport

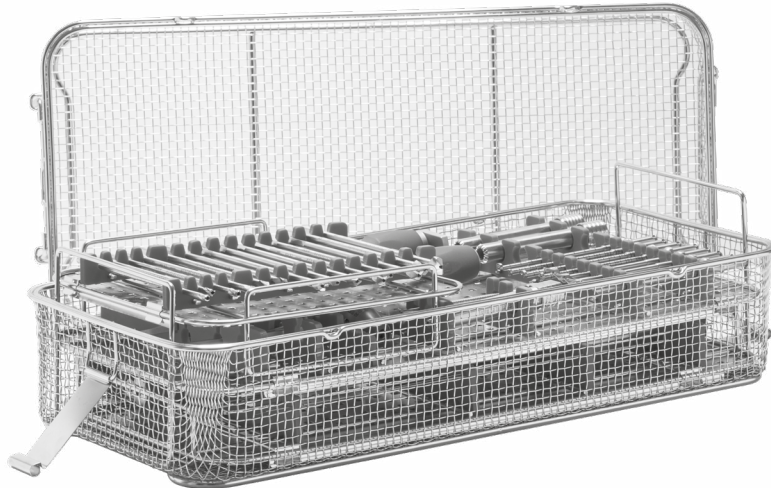

1

	Breite / Width mm	Gesamthöhe / Total height mm	Tiefe / Depth mm	Type / Type
<p>Sterilisationskorb ACL / PCL 1 bestehend aus: Siebkorbunterteil, 2 Instrumententräger mit Aufnahme-Einheiten und Silikon- aufnahmen sowie Zusatzebene für Instrumente ACL/PCL 1, Siebkorbdeckel mit Federverschluss und 2 Griffen</p> <p>Sterilization basket ACL / PCL 1 consisting of: Basket lower part, 2 instrument racks with support bars, basket and silicone holders additional instrument rack for instruments ACL/PCL 1, basket lid with spring lock and 2 handles</p>	530	150	250	85841220

suitable for standard container

passend für Standard Container (1 STE = 1 Sterilguteinheit)

**Sterilization Basket
for Instruments**

Knee Arthroscopy - ACL / PCL 2
Sterilization - Storage - Transport

**Sterilisationskorb
für Instrumentarium**

Knie-Arthroskopie - ACL / PCL 2
Sterilisation - Lagerung - Transport

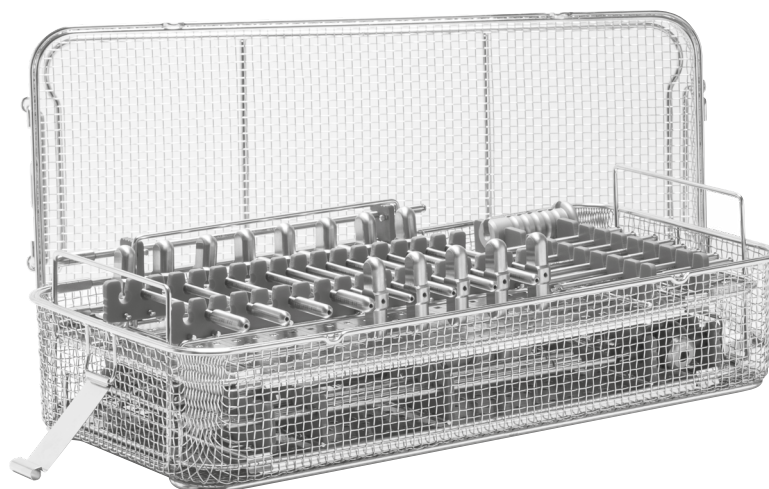

1

	Breite / Width mm	Gesamthöhe / Total height mm	Tiefe / Depth mm	Type / Type
<p>Sterilisationskorb ACL / PCL 2 bestehend aus: Siebkorbunterteil, 2 Instrumententräger mit Aufnahme-Einheiten und Silikon- aufnahmen für Instrumente ACL / PCL 2, Siebkorbdeckel mit Federverschluss und 2 Griffen</p> <p>Sterilization basket ACL / PCL 2 consisting of: Basket lower part, 2 instrument racks with support bars, basket and silicone holders for instruments ACL / PCL 2, basket lid with spring lock and 2 handles</p>	530	150	250	85841219

suitable for standard container

passend für Standard Container (1 STE = 1 Sterilguteinheit)

Sterilization Basket
for Instruments
Knee Arthroscopy - Workplate
Sterilization - Storage - Transport

Sterilisationskorb
für Instrumentarium
Knie-Arthroskopie - Arbeitsplatte
Sterilisation - Lagerung - Transport

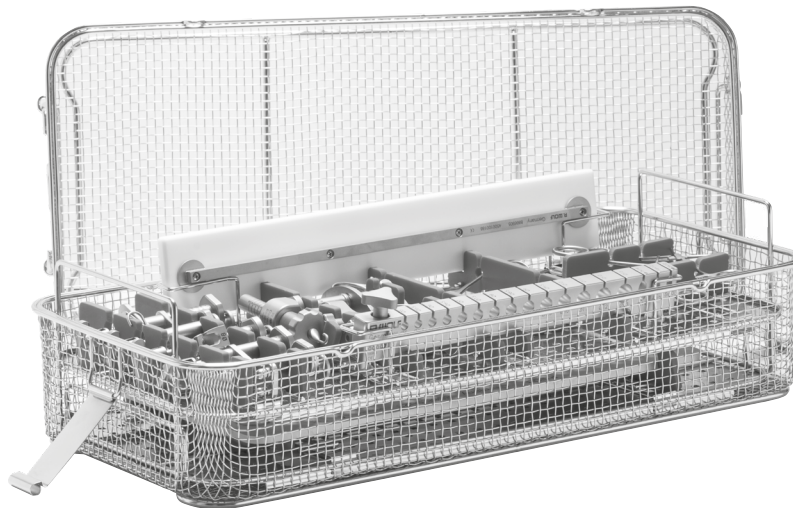

1

	Breite / Width mm	Gesamthöhe / Total height mm	Tiefe / Depth mm	Type / Type
<p>Sterilisationskorb Arbeitsplatte bestehend aus: Siebkorbunterteil, 2 Instrumententräger mit Aufnahme-Einheiten und Silikon- aufnahmen für Präparations- Arbeitsplatte, Siebkorbdeckel mit Federverschluss und 2 Griffen</p> <p>Sterilization basket Workplate consisting of: Basket lower part, 2 instrument racks with support bars, basket and silicone holders for preparation workplate, basket lid with spring lock and 2 handles</p>	530	150	250	85841218

suitable for standard container

passend für Standard Container (1 STE = 1 Sterilguteinheit)

*Sterilization Basket
for Instruments
VERTEBRIS lumbar
Sterilization - Storage - Transport*

*Sterilisationskorb
für Instrumentarium
VERTEBRIS lumbal
Sterilisation - Lagerung - Transport*

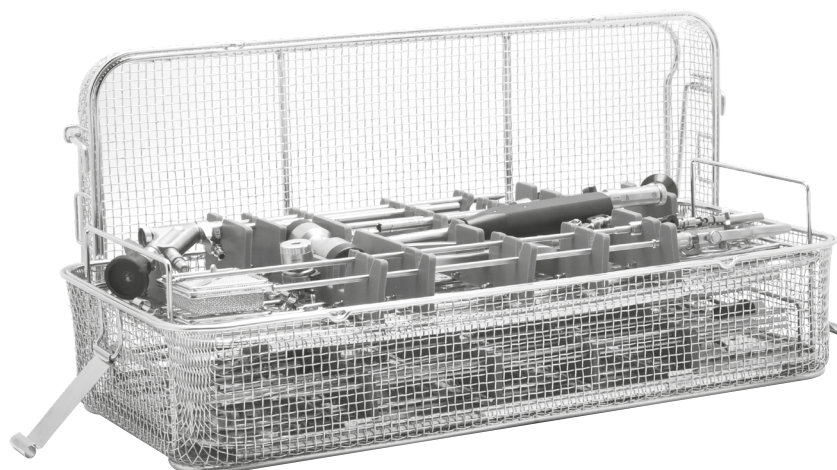

1

	Breite / Width mm	Gesamthöhe / Total height mm	Tiefe / Depth mm	Type / Type
<p>Sterilisationskorb VERTEBRIS lumbal bestehend aus: Siebkorbunterteil, 2 Instrumententräger mit Aufnahme-Einheiten und Silikon- aufnahmen für Instrumente VERTEBRIS lumbal, Siebkorbdeckel mit Federverschluss und 2 Griffen</p> <p>Sterilization basket VERTEBRIS lumbar consisting of: Basket lower part, 2 instrument racks with support bars, basket and silicone holders for instruments VERTEBRIS lumbar, basket lid with spring lock and 2 handles</p>	530	150	250	85841217

suitable for standard container

passend für Standard Container (1 STE = 1 Sterilguteinheit)

Sterilization Basket
for Instruments
reconstructive shoulder arthroscopy
Sterilization - Storage - Transport

Sterilisationskorb
für Instrumentarium
Schulter-Arthroskopie
Sterilisation - Lagerung - Transport

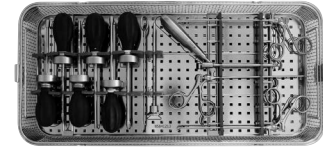
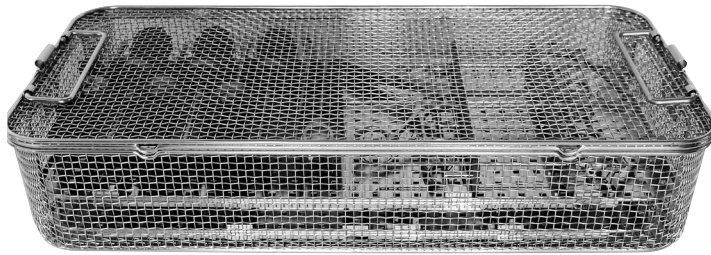

oben / up

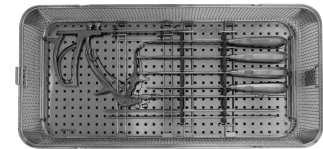

unten / bottom

	Breite / Width mm	Gesamthöhe / Total height mm	Tiefe / Depth mm	Type / Type
<p>Sterilisationskorb für Schulternaht-Set bestehend aus: Siebkorbunterteil, 2 Instrumententräger mit Aufnahme-Einheiten und Silikonaf- nahmen für Instrumenten-Set "Schulter", Siebkorbdeckel mit Federverschluss und 2 Griffen</p> <p>Sterilization basket <i>shoulder arthroscopy</i> consisting of: Basket lower part, 2 instrument racks with support bars, basket and silicone holders for instrument set "shoulder", basket lid with spring lock and 2 handles</p>	530	108	250	85841213

suitable for standard container

passend für Standard Container (1 STE = 1 Sterilguteinheit)

Sterilization basket
for flexible Endoscopes
Sterilization - Storage - Transport

Sterilisationskorb
für flexible Endoskope
Sterilisation - Lagerung - Transport

1

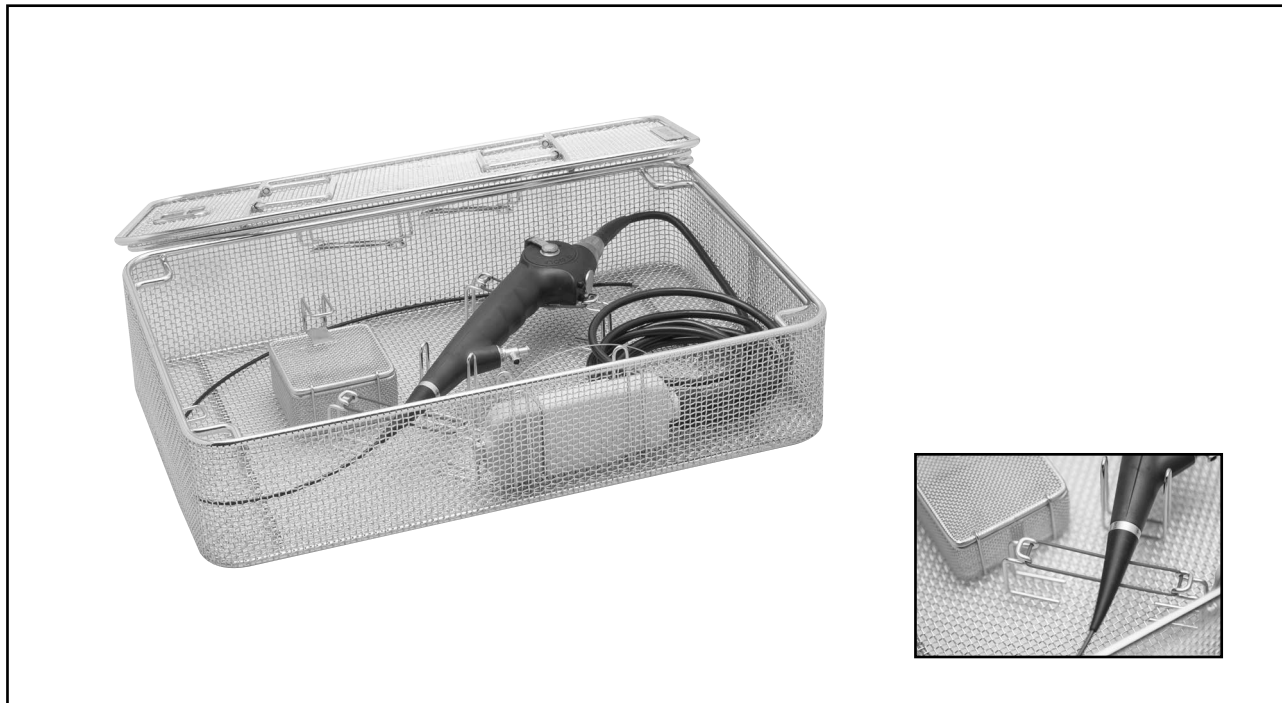

	Breite / Width mm	Gesamthöhe / Total height mm	Tiefe / Depth mm	Type / Type
<p>Sterilisationskorb flexible Endoskope bestehend aus: Siebkorbunterteil mit integriertem Kleinteilesieb, Halterungen und O-Ringen aus Silikon, Siebkorbdeckel mit Federverschluss und 2 Griffen</p> <p>Sterilization basket flexible endoscopes consisting of: Basket lower part with integrated small part basket, brackets and silicone O-rings, basket lid with spring clip and 2 handles</p>	448	106	288	85841240

Spare O-ring set 643301261

Ersatz O-Ring-Set 643301261

Sterisafe® DURO A3 Steri Container
for flexible endoscopes
Sterilization - Storage - Transport

Steribehälter Sterisafe® DURO A3
für flexible Endoskope
Sterilisation - Lagerung - Transport

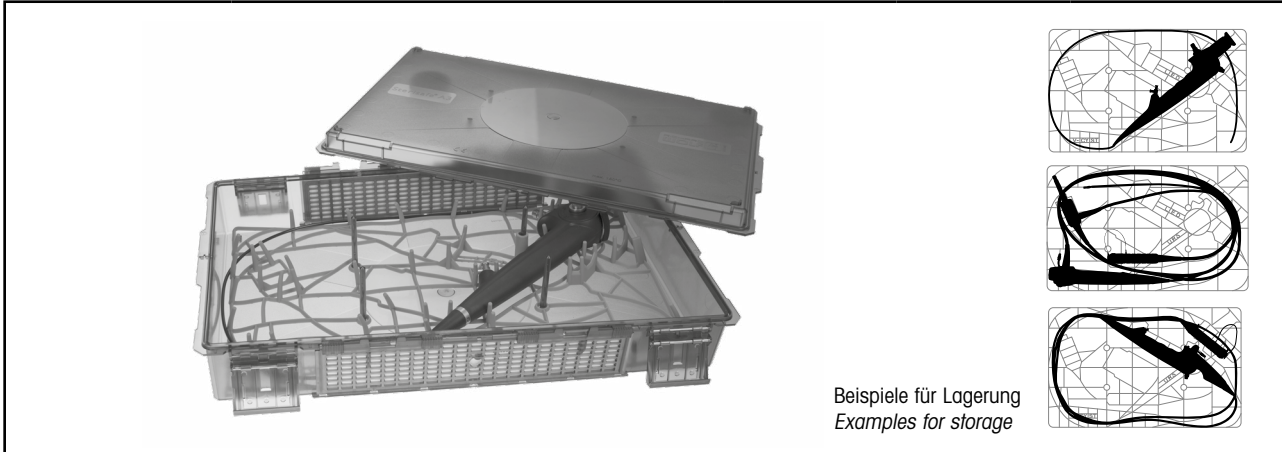

Beispiele für Lagerung
Examples for storage

	bestehend aus: consisting of:	Außenmaße (B x H x T) Outer dimensions (W x H x D)	Innenmaße (B x H x T) Inner dimensions (B x H x D)	Type / Type
Sterisafe® DURO A3 Steribehälter komplett, für Plasma-Sterilisation Sterisafe® DURO A3 steri container bundle, for plasma sterilization	Sterisafe® DURO A3 (382031003), Toolsafe® Gitterunterlage (382031101), Einwegfilter für H ₂ O ₂ , VE=100 ST (382031401) Sterisafe® DURO A3 (382031003), Toolsafe® grid frame (382031101), Disposable filter for H ₂ O ₂ PACK=100 PCS, (382031401)	450 x 87 x 292 mm	420 x 75 x 265 mm	382032000*
Sterisafe® DURO A3 Steribehälter komplett, für EO und FA Sterisafe® DURO A3 steri container bundle, for EO (ethylene oxide) and FA (formaldehyde)	Sterisafe® DURO A3 (382031003), Toolsafe® Gitterunterlage (382031101), Einwegfilter für EO und FA, VE=100 ST (382031501) Sterisafe® DURO A3 (382031003), Toolsafe® grid frame (382031101), Disposable filter for EO and FA PACK=100 PCS, (382031501)			382032100

- offers flexible endoscopes safe storage in a sterile barrier and packaging system in conformity with DIN EN ISO 11607
- is suitable for plasma, ethylene oxide and formaldehyde sterilization procedures

- bietet flexiblen Endoskopen eine sichere Lagerung in einem Sterilbarriere- und Verpackungssystem nach DIN EN ISO 11607
- ist geeignet für Plasma-, Ethylenoxid- und Formaldehyd-Sterilisationsverfahren

Accessories:

- Disposable filter, PACK= 100 PCS,**
- for H₂O₂ 382031401
 - for EO and FA 382031501
 - Sterisafe® universal label holder** 382031203
 - Sterisafe® safety seal, PACK= 100 PCS** 382031202
 - Toolsafe® grate base** 382031101

Zubehör:

- Einwegfilter, VE= 100 ST,**
- für H₂O₂ 382031401
 - für EO und FA 382031501
 - Sterisafe® Universal Etikettenhalter** 382031203
 - Sterisafe® Sicherungsplombe, VE= 100 St.** 382031202
 - Toolsafe® Gitterunterlage** 382031101

Filter system:

Disposable filter for plasma sterilization procedure (STERRAD®, H₂O₂),
Disposable filter for ethylene oxide (EO) and formaldehyde (FA) sterilization procedure

Filtersystem:

Einmalfilter für Plasma-Sterilisations-Verfahren (STERRAD®, H₂O₂),
Einmalfilter für Ethylenoxid- (EO) und Formaldehyd- (FA) Sterilisations-Verfahren

* not suitable for "COBRA vision" and "COBRA vision EF".

* nicht für "COBRA vision" und "COBRA vision EF" geeignet.

Sterisafe® DURO A3 Steri Container
Universal, Steam - H₂O₂
for rigid instruments
Steam sterilization

Steribehälter Sterisafe® DURO A3
Universal, Dampf - H₂O₂
für starre Instrumente
Dampfsterilisation

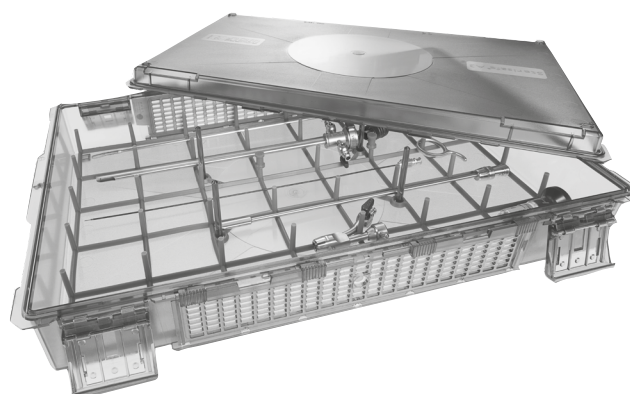

1

	bestehend aus: consisting of:	Außenmaße (B x H x T) Outer dimensions (W x H x D)	Innenmaße (B x H x T) Inner dimensions (B x H x D)	Type / Type
Sterisafe® DURO A3 Universal Steribehälter komplett Dampf für Dampfsterilisation Sterisafe® DURO A3 Universal steri container bundle Steam for steam sterilization	Sterisafe® DURO A3 (382031003), Toolsafe® Gitterunterlage A3 Universal (382031102), Einwegfilter D, EO, FA VE=100 ST (382031501)	450 x 87 x 295 mm	420 x 75 x 265 mm	382032300
Sterisafe® DURO A3 Universal Steribehälter komplett H₂O₂ für Dampfsterilisation Sterisafe® DURO A3 Universal steri container bundle H₂O₂ for steam sterilization	Sterisafe® DURO A3 (382031003), Toolsafe® Gitterunterlage A3 Universal (382031102), Einwegfilter H ₂ O ₂ VE=100 ST (382031401)	450 x 87 x 295 mm	420 x 75 x 265 mm	382032200

- offers flexible endoscopes safe storage in a sterile barrier and packaging system in conformity with DIN EN ISO 11607
- is suitable for plasma, ethylene oxide and formaldehyde sterilization procedures

- bietet Endoskopen eine sichere Lagerung in einem Sterilbarriere- und Verpackungssystem nach DIN EN ISO 11607
- hervorragend geeignet zur Dampfsterilisation starrer Instrumente

Accessories:

- Disposable filter, PACK= 100 PCS,**
- for H₂O₂ 382031401
- for steam, EO and FA 382031501
- Sterisafe® universal label holder** 382031203
- Sterisafe® safety seal, PACK= 100 PCS** 382031202
- Toolsafe® grate base A3 universal** 382031102

Zubehör:

- Einwegfilter, VE= 100 ST,**
- für H₂O₂ 382031401
- für D, EO und FA 382031501
- Sterisafe® Universal Etikettenhalter** 382031203
- Sterisafe® Sicherungsplombe, VE= 100 ST** 382031202
- Toolsafe® Gitterunterlage A3 Universal** 382031102

Filter system:

Disposable filter for plasma sterilization procedure (STERRAD®, H₂O₂),
 Disposable filter for steam, ethylene oxide (EO) and formaldehyde (FA) sterilization procedure

Filtersystem:

Einmalfilter für Plasma-Sterilisations-Verfahren (STERRAD®, H₂O₂),
 Einmalfilter für Dampf, Ethylenoxid- (EO) und Formaldehyd- (FA) Sterilisations-Verfahren

RIWO-SYSTEM-TRAY

Steam and low temperature process
Sterilization - Storage - Transport

RIWO-SYSTEM-TRAY

Dampf- und Niedertemperatur-Verfahren
Sterilisation - Lagerung - Transport

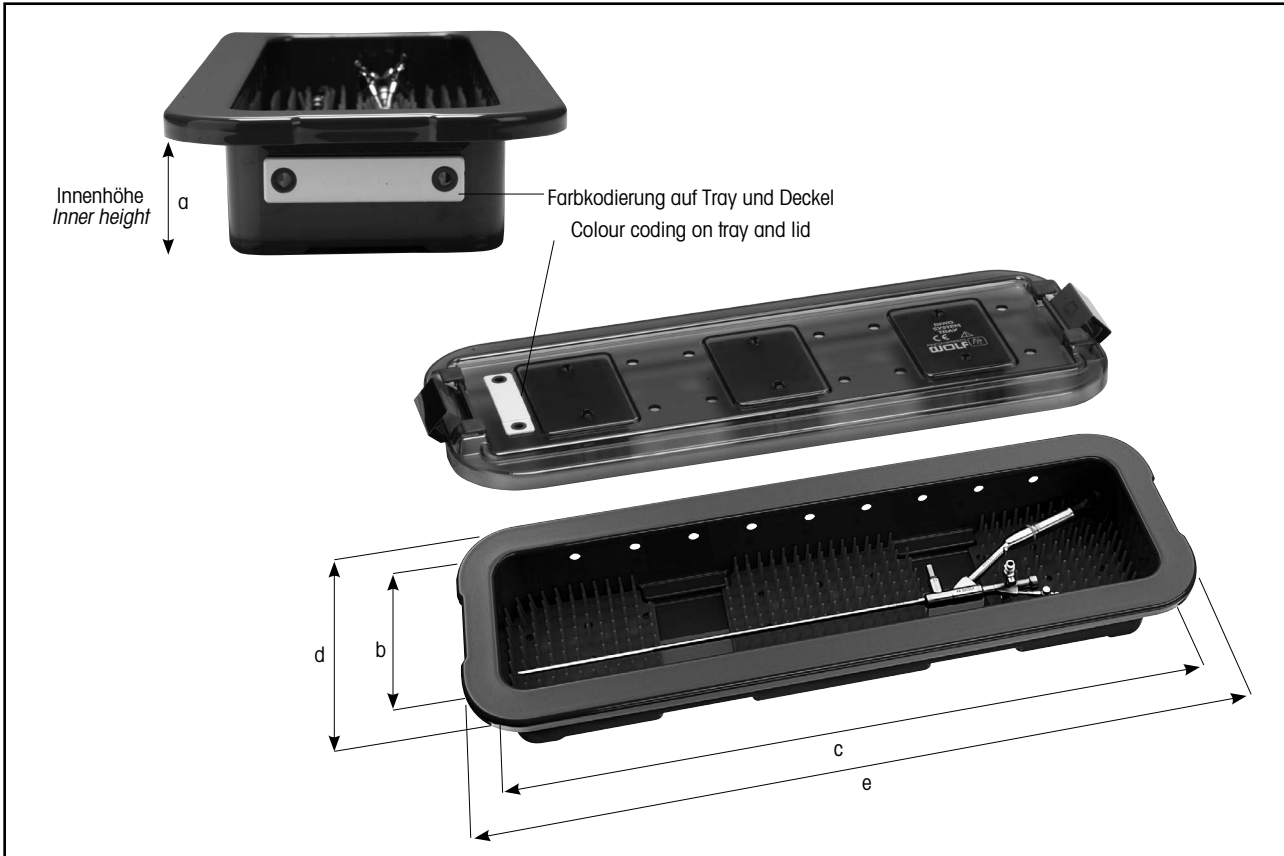

	Innenmaße / Inner dimensions			Außenmaße / Outer dimensions		Type / Type
	a Höhe / Height mm	b Breite / Width mm	c Länge / Length mm	d Breite / Width mm	e Länge / Length mm	
RIWO-System-Tray Sterbehälter universal einsetzbar	75	120	500	186	566	38201.583
RIWO-System-Tray Steri container universal application	75	120	700	186	766	38201.783

Sterilisierungsschutzhülse zur Aufnahme von max. 5 Stück Resektions- oder Vaporisations-Elektroden oder Urethrotommeser Protective sterilization sleeve for a maximum of 5 pieces resection or vaporisation electrodes or urethrotome knives	 AUTOCLAVE 134° C / 273° F		8428.901
	Länge / Length 328 mm	Außen-Ø / Outer Ø 20 mm	

RIWO-SYSTEM-TRAY

Steam and low temperature process
Sterilization - Storage - Transport

RIWO-SYSTEM-TRAY

Dampf- und Niedertemperatur-Verfahren
Sterilisation - Lagerung - Transport

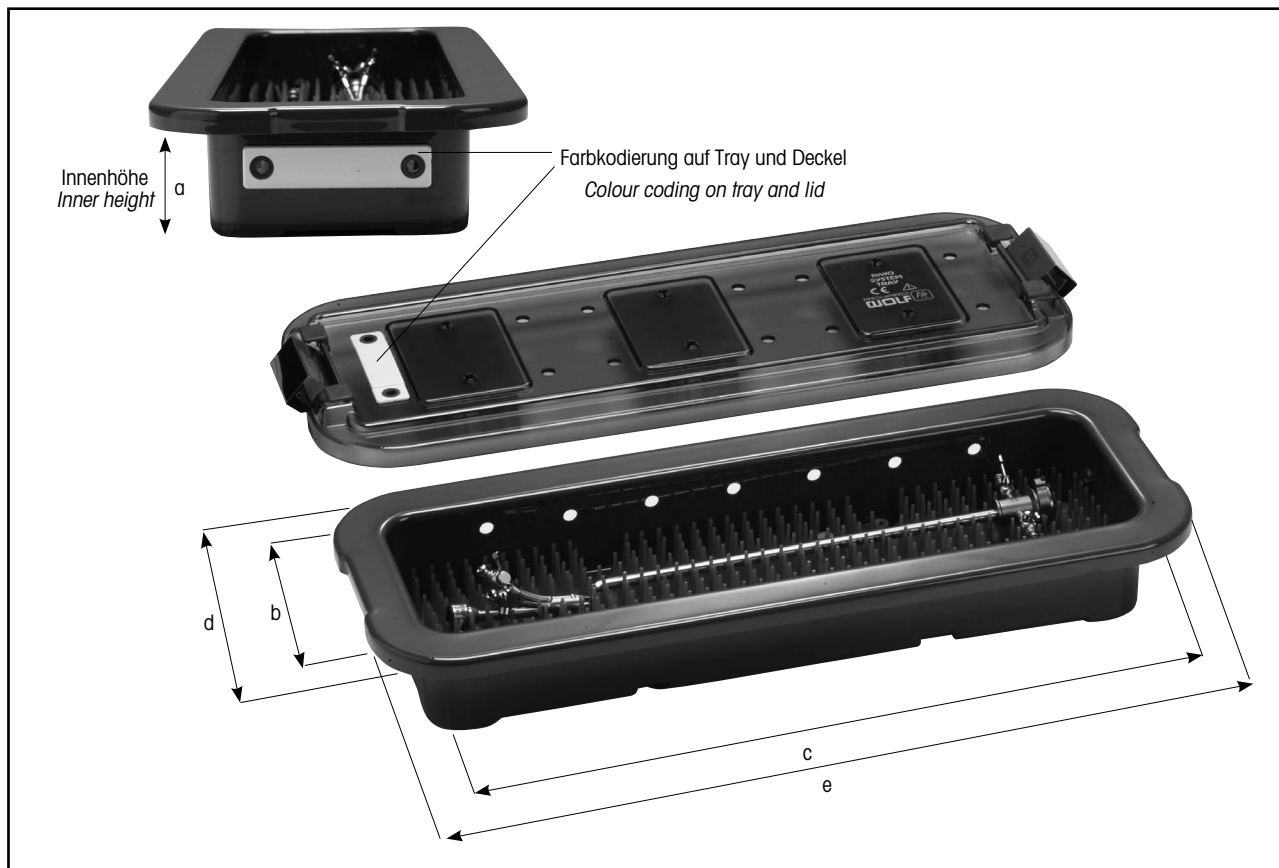

	Innenmaße / Inner dimensions			Außenmaße / Outer dimensions		Noppen- mattenset / Peg mat set	Type / Type
	a Höhe / Height mm	b Breite / Width mm	c Länge / Length mm	d Breite / Width mm	e Länge / Length mm		
RIWO-System-Tray Steribehälter bestehend aus: Instrumenten-Behälter mit eingelegeten Noppenmatten, Deckel mit fixierten Noppenmatten, 2 Codierstiften (weiß) und 1 Markierungsstift RIWO-System-Tray Steri container consisting of: instrument container with inserted peg mats, lid with fixed peg mats, 2 coding pins (white) and 1 highlighter	60	120	300	186	366	38201.321	38201.382
	60	200	300	266	366	38201.322	38201.386
	60	120	400	186	466	38201.323	38201.482
	60	200	400	266	466	38201.324	38201.486
	60	120	500	186	566	38201.323	38201.582
	60	200	500	266	566	38201.324	38201.586
	60	200	600	266	666	38201.326	38201.686
	60	120	700	186	766	-	38201.782
	60	200	700	266	766	38201.326	38201.786

Accessories **RIWO-System-Tray** see overleaf.

Zubehör **RIWO-System-Tray** siehe Rückseite.

RIWO-SYSTEM-TRAY

Accessories

RIWO-SYSTEM-TRAY

Zubehör

Instrumenten-Behälter, 60 mm hoch <i>Instrument container,</i> 60 mm high	Zubehör-Behälter 100 mm hoch <i>Accessory container,</i> 100 mm high	Noppenmatten-Set für Instrumenten- oder Zubehör-Behälter Peg Mat Set for instrument or accessory container	Deckel Lid	Noppenmatte für Deckel Peg mat for lid
				
	ohne Noppenmatten <i>without peg mats</i>		ohne Noppenmatten <i>without peg mats</i>	inkl. Druckknöpfen (pro Deckel wird 38201.319 3 bzw. 4 mal benötigt) <i>incl. snap fasteners</i> (38201.319 is required 3 or 4 times for each lid)
38201.382	–	38201.321	–	3x 38201.316
38201.386	–	38201.322	–	3x 38201.319
38201.482	–	38201.323	–	3x 38201.316
38201.486	38202.409	38201.324	38202.494	3x 38201.319
38201.582	–	38201.323	–	3x 38201.316
38201.586	38202.509	38201.324	38202.594	3x 38201.319
38201.686	38202.609	38201.326	38202.694	4x 38201.319
38201.782	–	–	–	4x 38201.316
38201.786	38202.709	38201.326	38202.794	4x 38201.319

RIWO-SYSTEM-TRAY
for Telescope
Sterilization

RIWO-SYSTEM-TRAY
für Optik
Sterilisation

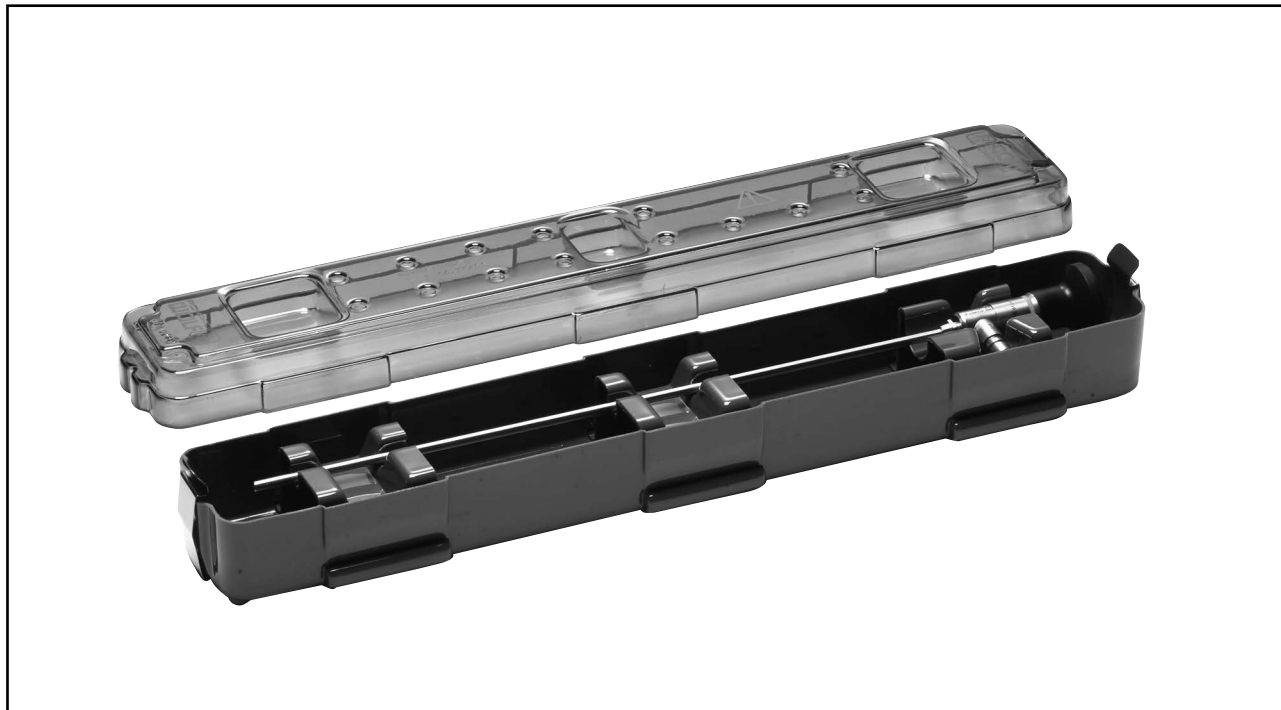

1

	Breite / Width mm	Gesamthöhe / Total height mm	Tiefe / Depth mm	Type / Type
Steribehälter Aufnahmekapazität: 1 Optik Sterilization basket Capacity: 1 telescope	400	60	70	8544.021

RIWO-BOX

Washing - Disinfection - Neutralisation

RIWO-BOX

Reinigung - Desinfektion - Neutralisation



6860.901 / 8509.01



6860.911

	dampfsterilisierbar steam sterilizable	Siebkorb-Innenmaße / Basket inner dimensions			Außenmaße / Outer dimensions			Type / Type
		Breite / Width mm	Höhe / Height mm	Tiefe / Depth mm	Breite / Width mm	Höhe / Height mm	Tiefe / Depth mm	
RIWO-BOX Desinfektionswanne mit Deckel und Siebkorb	-	432	100	150	552	165	200	6860.901
RIWO-BOX Disinfection basin with lid and perforated basket	●	432	100	150	552	165	200	8509.01
	-	760	100	150	881	165	200	6860.911

RIWO-BOX

Washing - Disinfection - Neutralisation

RIWO-BOX

Reinigung - Desinfektion - Neutralisation

2



	Innenmaße / Inner dimensions			Außenmaße / Outer dimensions			Type / Type
	Breite / Width mm	Höhe / Height mm	Tiefe / Depth mm	Breite / Width mm	Höhe / Height mm	Tiefe / Depth mm	
RIWO-BOX Desinfektionswanne mit Deckel <i>RIWO-BOX</i> <i>Disinfection basin</i> with lid	548	100	348	600	140	400	509.81

Water Jet Cleaning Gun

Wasserstrahl-Reinigungspistole

3

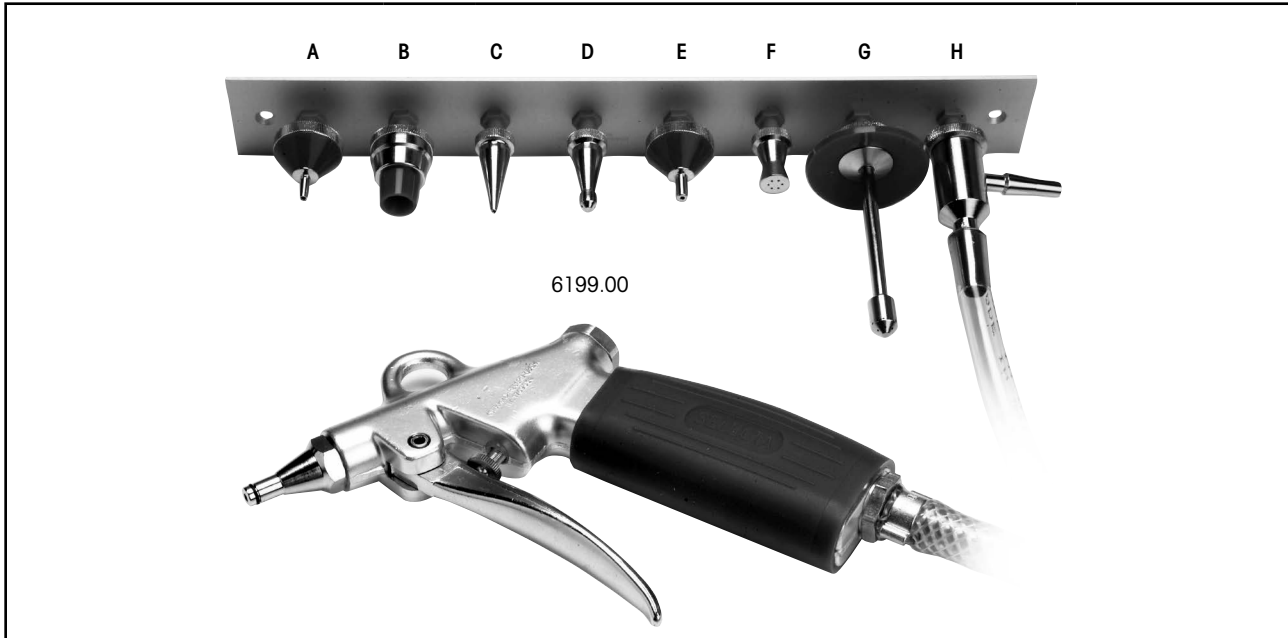





		Type / Type
<p>Wasserstrahl-Reinigungspistole inkl. Reinigungspistolen-Ansätze (A-H) und Halterung</p> <p>Water jet cleaning gun incl. clean pistol mounting (A-H) and holder</p>	<p>zum Anschluss an Wasserleitungshahn mit R-3/4"-Gewinde</p> <p>for connection to tap water with R-3/4" thread</p>	<p>6199.00</p>
<p>Reinigungspistolen-Ansätze (A-H)</p> <p>Clean gun mounting (A-H)</p>	<p>Die Ansätze eignen sich zum Reinigen von</p> <p>The adapters are suitable for cleaning the following</p>	
	<p>A Schäften und Einsätzen, Spritzen, Injektionskanülen Sheaths and inserts, syringes, injection cannulas</p>	15515.003
	<p>B Schäften, Mess- und Blutpipetten Sheaths, measuring and blood pipettes</p>	15515.004
	<p>C Kathetern Sheaths, measuring and blood pipettes</p>	15515.005
	<p>D Drainageschläuchen Drainage tubes</p>	15515.006
	<p>E Hähnen, Kanülen und Spritzen Taps, cannulas and syringes</p>	15515.007
	<p>F Brauseansätzen Douche attachments</p>	15515.009
	<p>G Flaschen Bottles</p>	15515.008
<p>H Wasserstrahlpumpen (mit Ansätzen auch zum Trocknen geeignet) Water jet pumps (with attachments also suitable for drying)</p>	15515.010	

Cleaning Accessories

Reinigungs-Zubehör

3

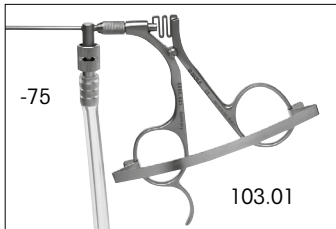
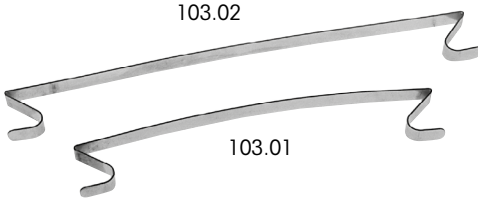









			Type / Type
	Demontagehilfe <i>Dissassembly tool</i>	zum einfachen Demontieren von O-Ringen <i>for easy removal of O-rings</i>	15106.230
	Druckball <i>Pressure ball</i>	zum Durchblasen von Kanälen <i>for blowing air through channels</i>	103.00
	Lupe <i>Magnifier</i>	wiederverwendbar <i>reusable</i>	9500.103

<p><i>For machine reprocessing and ultrasound</i></p> <p><i>We recommend having both types on hand.</i></p>		<p><i>Für die maschinelle Aufbereitung und Ultraschall</i></p> <p><i>Wir empfehlen Ihnen, beide Typen vorrätig zu haben.</i></p>	
	103.01		103.02
Reinigungsklammer, kurz <i>Cleaning clamp, short</i>	Spannbereich bis 75 mm (VE= 10 ST) <i>Clamping range up to 75 mm (PACK= 10 PCS)</i>	Reinigungsklammer, lang <i>Cleaning clamp, long</i>	Spannbereich 75 - 110 mm (VE= 10 ST) <i>Clamping range 75 - 110 mm (PACK= 10 PCS)</i>
Reinigungsklammer für Arbeitselemente <i>Cleaning clamp for working elements</i>		Reinigungsklammer <i>Cleaning clamp</i>	für die maschinelle Aufbereitung des Saug- Spülhandgriffs 8475.26 <i>for machine reprocessing of suction and irrigation handle 8475.26</i>
			Type / Type
			103.01
			103.02
			15242024
			8475621

Adapter for washer-disinfector
Machine Reprocessing





**Adapter für Reinigungs- und
Desinfektionsautomat**
Maschinelle Aufbereitung

3

	Bezeichnung / Article description	passend / suitable	Type / Type
	Spüladapter , Ø 9 mm, Länge 64 mm <i>Irrigation adapter</i> , Ø 9 mm, length 64 mm	für isolierte Schafftröhre / for insulated sheath tubes 8388200 / 8388201 / 8388202 / 8388203 / 8390933 / 8391933 / 8392933 / 8393933 / 8394933 / 8392935 / 8393935 / 8394935	163502
	Spüladapter <i>Irrigation adapter</i>	für unisolierte Schafftröhre for uninsulated sheath tubes	163503
	Adapter <i>Adapter</i>	für Dichtigkeitstest in OLYMPUS-E-RDG-Spülmaschinen for leakage testing in OLYMPUS endoscope washer / disinfecter	163.905
	Spüladapter <i>Irrigation adapter</i>	für flexible Bronchoskope mit Absaugventil for flexible bronchoscope with suction valve	163912
	Adapter <i>Adapter</i>	für Uretero-Renoskope zur Reinigung des Laserfaserkanals for uretero renosscopes for cleaning the laser fiber channel	163914
	Spüladapter <i>Irrigation adapter</i>	für Motorhandgriff / for motor handpiece 8564.021	163951
	Spüladapter <i>Irrigation adapter</i>	für Motorhandgriffe / for motor handpieces 89955.0000, 89955.0003, 89955.00001, 89955.00031	163955
	Spüladapter <i>Irrigation adapter</i>	für Motorhandgriff / for motor handpiece 89951.0001	163956
	Anschlussstück <i>Connecting part</i>	für flexible Endoskope for flexible endoscopes	15028.083
	Anschlussstück <i>Connecting part</i>	für flexible Bronchoskope for flexible bronchoscopes	15028103

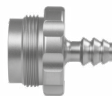
*Adapter for washer-disinfector
Machine Reprocessing*

Adapter für Reinigungs- und
Desinfektionsautomat
Maschinelle Aufbereitung

	Bezeichnung / Article description	passend / suitable	Type / Type
	Adapter <i>Adapter</i>	für Dichtigkeitstest in E-RDG-Spülmaschinen anderer Hersteller <i>for leakage testing in endoscope washers / disinfectors of other manufacturers</i>	15092.102
	Spüladapter <i>Irrigation adapter</i>	für Aufbereitungskorb 38042.111 / 38044.211 / 38046.111 <i>for reprocessing basket 38042.111 / 38044.211 / 38046.111</i>	64164.031
	Spüladapter <i>Irrigation adapter</i>	für Aufbereitungskorb 38042.311 <i>for reprocessing basket 38042.311</i>	64164.038
	Spüladapter <i>Irrigation adapter</i>	für Aufbereitungskorb 38044.111 / 38044.611 <i>for reprocessing basket 38044.111 / 38044.611</i>	64164.039
	Spüladapter <i>Irrigation adapter</i>	für DuoRotate Zangen / Scheren 5 mm / 10 mm <i>for DuoRotate forceps / scissors 5 mm / 10 mm</i>	8399300
	Schlauchset <i>Tube set</i>	zum Instrumenten-Anschluss <i>for instrument connection</i>	38040.901

3

Adapter for washer-disinfector
Machine Reprocessing of flexible Endoscopes

Adapter für Reinigungs- und Desinfektionsautomat
Maschinelle Aufbereitung flexibler Endoskope

3

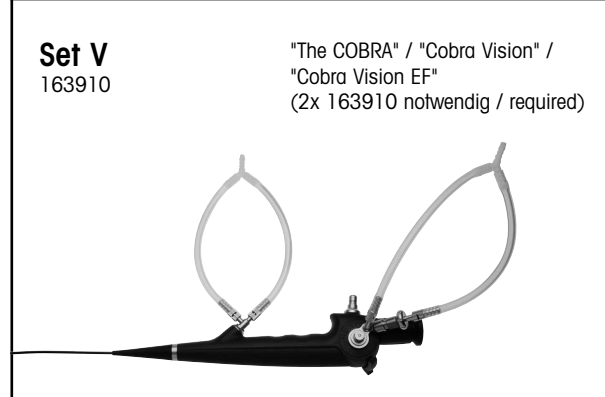
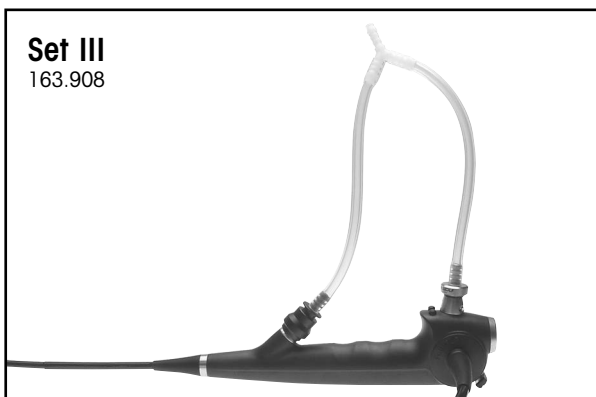
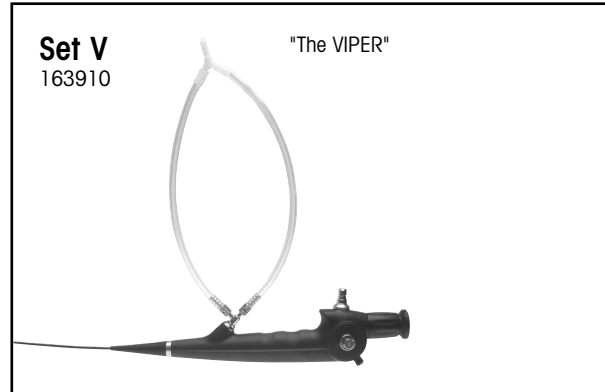
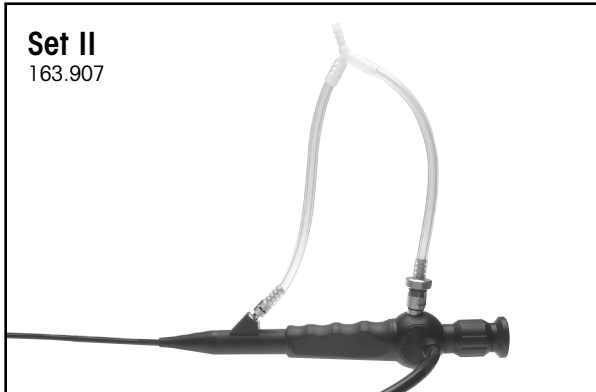

Irrigation set II
for flexible Bronchoscopes, DAFE bronchoscopes 163.907

Spülset II
für flexible Bronchoskope, DAFE Bronchoskope 163.907

Irrigation set III
for Video-urethro-cystoscopes, PDD Video-urethro-cystoscopes,
Video-bronchoscopes, DAFE video-bronchoscopes 163.908

Spülset III
für Video-Urethro-Cystoskope, PDD Video-Urethro-Cystoskope,
Video-Bronchoskope, DAFE Video-Bronchoskope 163.908

Irrigation set V
with double luer lock tube connector
for flexible Fiber-uretero-renoscopes and
flexible Sensor Uretero Renoscopes 163910

Spülset V
mit Doppel-Luer-Lock-Schlauchteil
für flexible Fiber-Uretero-Renoskope und
flexible Sensor Uretero-Renoskope 163910

Tube with Luer lock connector
for flexible Urethro-cystoscopes, Hysteroscopes,
Nasopharyngo-laryngoscopes

Ø 3 mm, male	886.00
Ø 4 mm, male	886.01
Ø 3 mm, female	891.00
Ø 4 mm, female	15023.041

Luer-Lock-Schlauchteil
für flexible Urethro-Cystoskope, Hysteroskope,
Nasopharyngo-Laryngoskope

Ø 3 mm, männlich	886.00
Ø 4 mm, männlich	886.01
Ø 3 mm, weiblich	891.00
Ø 4 mm, weiblich	15023.041

*Cleaning Brush
for single use*

Reinigungsbürste
zum Einmalgebrauch

3

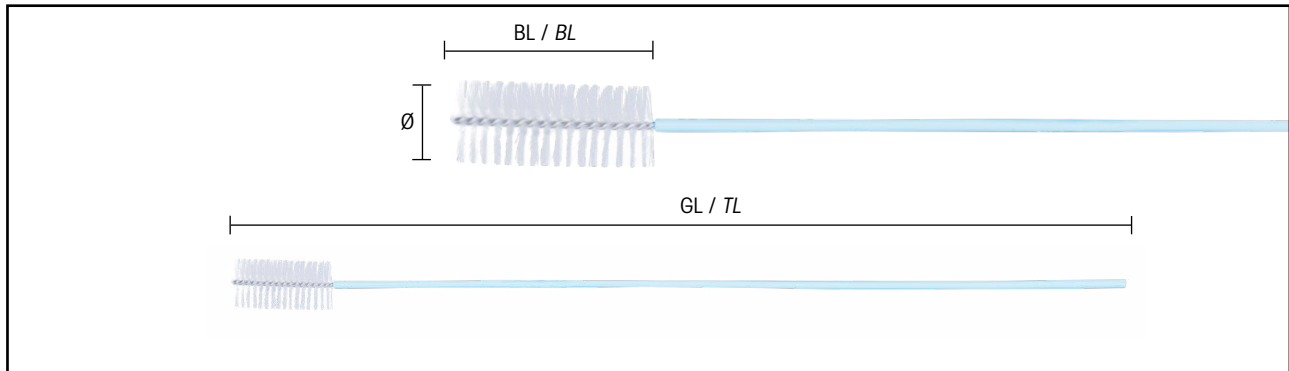

	Bürstenkopf / Brush head Ø mm	Bürstenlänge BL / Brush length BL mm	Gesamtlänge GL / Total length TL mm	Farbe Color	für Kanal / for channel Ø mm	Type / Type
Reinigungsbürste zum Einmalgebrauch (VE= 10 ST) Cleaning Brush for single use (PACK= 10 PCS)	2	20	400	blau blue	1.0 - 1.5	7970402
			700			7970702
	3	30	400	rot red	1.6 - 2.5	7970403
			700			7970703
	4	30	400	gelb yellow	2.6 - 3.5	7970404
			700			7970704
	5	48	400	grün green	3.6 - 4.5	7970405
			700			7970705
	7	48	400	violett purple	4.6 - 6.5	7970407
			700			7970707
	9	48	400	orange orange	6.6 - 8.5	7970409
			700			7970709
	11	48	400	weiß white	8.6 - 10.5	7970411
			700			7970711
Reinigungsbürste zum Einmalgebrauch (VE= 5 ST) Cleaning Brush for single use (PACK= 5 PCS)	14	48	400	pink pink	10.6 - 13.5	7970414
			700			7970714
	17	48	400	schwarz black	13.6 - 16.5	7970417
			700			7970717
	20	48	400	hellblau light blue	16.6 - 19.5	7970420
			700			7970720

Storage rack see overleaf.

Aufbereitungsleiste siehe Rückseite.

*Cleaning Brush
for single use
Storage rack*

Reinigungsbürste
zum Einmalgebrauch
Aufbewahrungsleiste



3

		Type / Type
Aufbewahrungsleiste Reinigungsbürsten <i>Storage rack for cleaning brushes</i>	zur Aufbewahrung und einfacher Entnahme von Reinigungsbürsten, zur Wandmontage, Material: Edelstahl, wiederverwendbar <i>For storing and easily removing cleaning brushes, for wall mounting, Material: stainless steel, reusable</i>	7970901

*Double Cleaning Brush
for single use
for stopcocks and stopcock plugs*

**Doppel-Reinigungsbürste
zum Einmalgebrauch
für Hähne und Hahnküken**

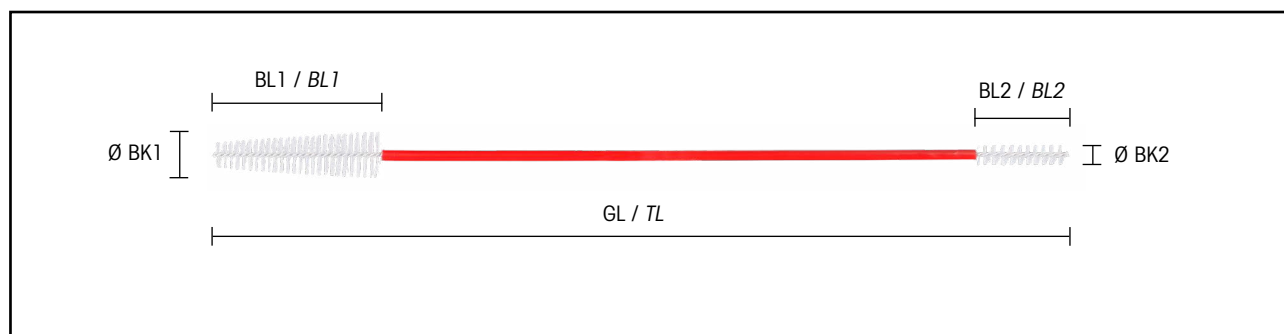

3

	Bürstenkopf BK <i>Brush head BK</i>		Bürstenlänge BL <i>Brush length BL</i>		Gesamtlänge GL / <i>Total length TL</i>	Farbe <i>Color</i>	für Hahnküken /-gehäuse mit <i>for stopcock inserts with</i>	Type / <i>Type</i>
	BK1 Ø mm	BK2 Ø mm	BL1 mm	BL2 mm	mm		Noppen / <i>Nubs</i>	
Reinigungsbürste doppel konisch gerade zum Einmalgebrauch (VE= 50 ST) Double conical straight cleaning brush <i>for single use (PACK= 50 PCS)</i>	konisch <i>conical</i> 4-7	3	35	20	180	blau <i>blue</i>	2	7980001
	konisch <i>conical</i> 5-9	4	35	20	180	rot <i>red</i>	3	7980002
	konisch <i>conical</i> 6-11	5	35	20	180	gelb <i>yellow</i>	4	7980003

hierzu: / *also:*



		Type / <i>Type</i>
Dispenser Reinigungsbürsten Dispenser for cleaning brushes	zur Aufbewahrung und einfacher Entnahme von Reinigungsbürsten, zur Tischmontage, Material: Edelstahl, wiederverwendbar <i>For storing and easily removing cleaning brushes, for table mounting, Material: stainless steel, reusable</i>	7980901

Cleaning Brush
for single use
for flexible endoscopes

Reinigungsbürste
zum Einmalgebrauch
für flexible Endoskope

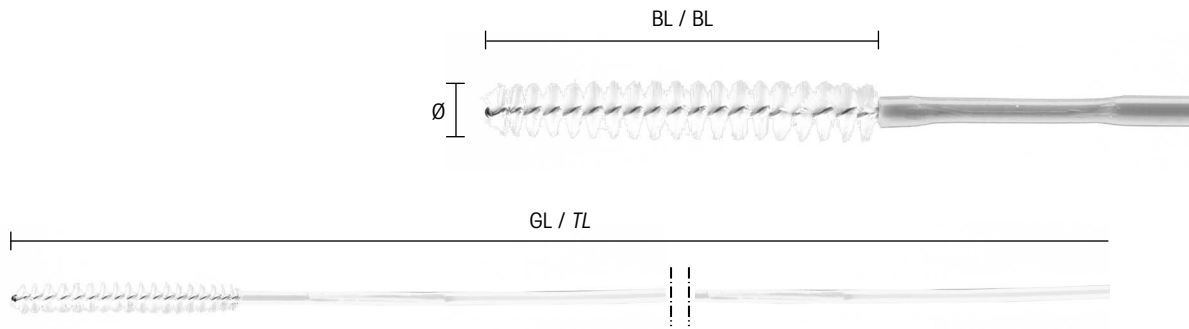

3

	Ø mm	Farbe Color	Bürstenlänge Brush length BL / BL mm	Gesamtlänge Total length GL / TL mm	Verwendung / Application		Type / Type
					in Arbeits- und Laserkanal in working and laser channel	in den flexiblen Endoskopen in the flexible endoscopes	
Reinigungsbürste zum Einmalgebrauch (VE= 10 ST) Cleaning Brush for single use (PACK= 10 PCS)	2	gelb yellow	15	1200	Ø 1.0 - 1.5 mm	7223.xxx 7325.xxx 7326.xxx 7330.xxx 7331.xxx	7990001
	3	grün green	20	1200	Ø 2.0 - 2.5 mm	7250.011 7265.xxx 7268.xxx 7269.xxx 7270.xxx 7305.xxx 7308.xxx 7309.xxx 7310.xxx	7990002
	0.85	blau blue	10	1200	Ø 0.8 mm	7356xxx	7990003
(VE= 100 ST / PACK= 100 PCS)	5	weiß white	20	1800	Ø 2.5 - 3.5 mm	7235xxx 7236xxx 7260xxx 7315xxx	7990004

Cleaning Brush
reusable

Reinigungsbürste
wiederverwendbar

3

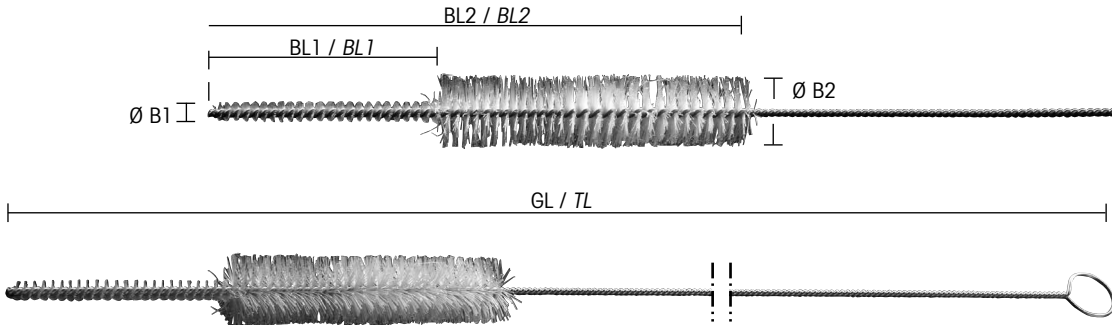

	Ø B1 mm	Ø B2 mm	Bürstenlänge Brush length BL1 / BL1 mm	Bürstenlänge Brush length BL2 / BL2 mm	Gesamtlänge Total length GL / TL mm	Type / Type
Reinigungsbürste	3	5	40	100	250	6.011
Cleaning Brush	3	13	40	100	250	6.012

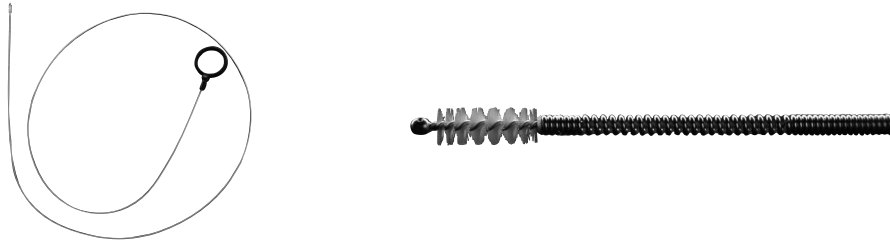

	Ø mm	für Arbeitskanal for working channel Ø mm	Bürstenlänge Brush length BL/BL mm	Arbeitslänge Working length NL/WL mm	Gesamtlänge Total length GL/OL mm	Type / Type
Reinigungsbürste	2.2	1.0 - 1.5	15	--	1200	7326911
	2.5	1.1 - 2.0	10	--	1000	7321.911
	3	2.0 - 2.5	8	--	1000	7264.691
	5	2.5 - 3.5	10	175	285	7268.691

*Cleaning Brush
for surface cleaning*

Reinigungsbürste
zur Oberflächenreinigung

3



	Bürstenlänge / Brush length BL / BL mm	Type / Type
Reinigungsbürste , gerade, zum Einmalgebrauch, (VE= 10 ST) <i>Cleaning brush</i> , straight, for single use (PACK = 10 PCS)	25	8691



	Bürstenlänge / Brush length BL / BL mm	Type / Type
Reinigungsbürste , abgewinkelt, dampfsterilisierbar <i>Cleaning brush</i> , angled, steam-sterilizable	42	86.90

Sterilization Accessories

Sterilisations-Zubehör

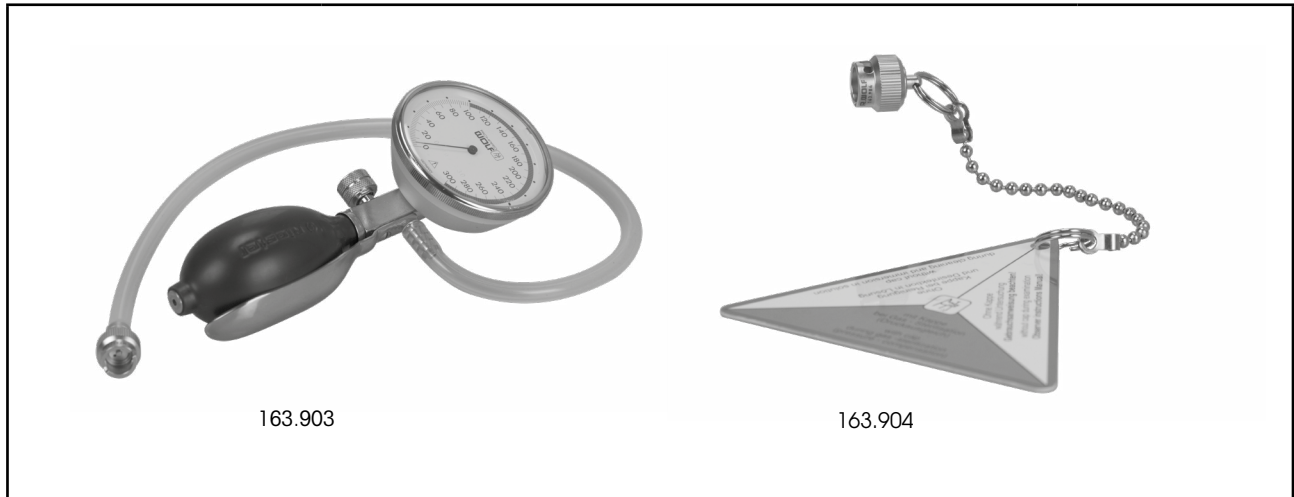

163.903

163.904

		Type / Type
Dichtigkeitstester für flexible Endoskope Leak tester for flexible endoscopes	wiederverwendbar <i>reusable</i>	163.903
Druckausgleichsventil Pressure equalization valve	wiederverwendbar <i>reusable</i>	163.904

Cleaning and Care Products

Reinigungs- und Pflegemittel

4



200.532







1001

		Type / Type
<p>Instrumenten-Öl, 30 ml</p> <p><i>Instrument oil,</i> 30 ml</p>	<p>für Trokarhülsen, Resektoskope, Hähne, Albarranhebel, flexible und starre Zangen</p> <p><i>for trocar sleeves, resectoscopes, stopcocks as well as flexible and rigid forceps</i></p>	<p>200.532</p>
<p>Polierpaste (VE= 5 ST)</p> <p><i>Polishing paste</i> (PACK= 5 PCS)</p>	<p>zum Entfernen von Rückständen auf optischen Endfenstern</p> <p><i>for removing residues on optical end windows</i></p>	<p>1001</p>

Replacement Stopcock Inserts

Ersatz-Hahnküken

	Demontierbare Hahnküken <i>Demountable stopcock inserts</i>	Type / Type
	<p>Hahnküken für Zweiwegehahn</p> <p>Stopcock plug for two-way stopcock</p>	15036060

	Noppen <i>Nubs</i>	Demontierbare Hahnküken <i>Demountable stopcock inserts</i>	Type / Type
	● ●	<p>Hahnküken, Durchlass 1,8 mm und 2,5 mm, Kennzeichen: 2 Noppen (VE= 5 ST)</p> <p>Stopcock inserts, capacity 1.8 mm and 2.5 mm, identification: 2 nubs (PACK = 5 PCS)</p>	896.0001
	● ● ●	<p>Hahnküken, Durchlass 3,0 mm, Kennzeichen: 3 Noppen (VE= 5 ST)</p> <p>Stopcock inserts, capacity 3.0 mm, identification: 3 nubs (PACK = 5 PCS)</p>	896.0002
	● ● ● ●	<p>Hahnküken, Durchlass 4,2 mm, Kennzeichen: 4 Noppen (VE= 5 ST)</p> <p>Stopcock inserts, capacity 4.2 mm, identification: 4 nubs (PACK = 5 PCS)</p>	896.0003

5

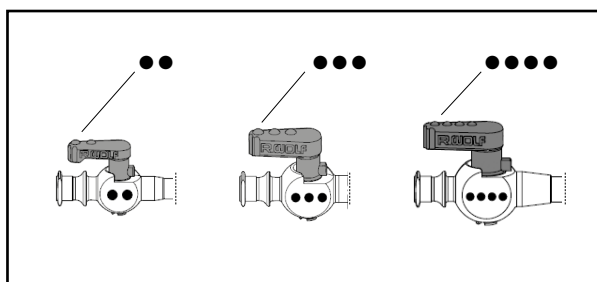

Damit es zu keinen Verwechslungen kommt, sind die Hahngehäuse mit der gleichen Anzahl von Noppen versehen, wie die passenden Hahnküken.

The stopcock housings and the corresponding stopcock inserts are marked with indicator nubs in order to simplify assembly.

Accessories
Rubber Seals

Zubehör
Gummidichtungen

6

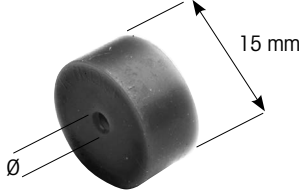
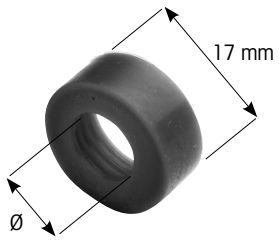
	Durchlass Capacity (Ø) mm	Farbe Colour	Type / Type
Dichtungskappe ohne Bohrung, klein, VE= 10 ST Sealing cap without holes, small, PACK= 10 PCS	-	rotorange / dark orange	89.20
Dichtungskappe, klein, VE= 10 ST Sealing cap, small, PACK= 10 PCS 	< 2.4	schwarz / black	89.00
	2.4 - 3.4	rot / red	89.01
	3.4 - 5.1	blau / blue	89.02
	5.1 - 6.0	grau / grey	89.03
	6.0 - 7.0	braun / brown	89.04
	7.0 - 8.0	gelb / yellow	89.05
Dichtungskappe ohne Bohrung, groß, VE=10 ST Sealing cap without holes, large, PACK= 10 PCS	-	rotorange / dark orange	89.21
Dichtungskappe, groß, VE=10 ST Sealing cap, large, PACK= 10 PCS 	9.5 - 10.1	rot / red	89.08
	> 10.1	blau / blue	89.09
	13.0 - 13.8	rot / red	89.10
	4 - 6	rot / red	89.141
	7.5 - 8.5	blau / blue	89.161
	7.0	braun / brown	89.171

Accessories
Rubber Seals / Rubber Caps

Zubehör
Gummidichtungen / Gummikappen

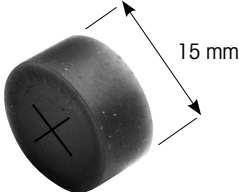
	Farbe Colour	Type / Type
<p>Dichtungskappe mit Kreuzschlitz, für Trocarhülse mit Gewindeschaff, VE= 10 ST</p> <p>Sealing cap with cross recess, for trocar sleeves with thread, PACK= 10 PCS</p> 	rotorange / dark orange	89.90

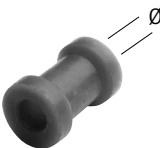

	Durchlass Capacity (Ø) mm	Farbe Colour	Type / Type
<p>RIWO Gummikappe ohne Bohrung, VE= 10 ST RIWO rubber cap without holes, PACK= 10 PCS</p>	-	rotorange / dark orange	88.00
<p>RIWO Gummikappe, VE= 10 ST RIWO rubber cap, PACK= 10 PCS</p> 	0.5	rot / red	88.005
	0.8	rotorange / dark orange	88.01
	1.4	blau / blue	88.02
	2.4	schwarz / black	88.03
<p>RIWO Gummikappe, für 5-mm-Instrumente, VE=10 ST RIWO rubber cap, for 5 mm instruments, PACK= 10 PCS</p>	4.0	grün / green	88.04

	Farbe Colour	Type / Type
<p>Gummikappe für Hysteroskop, verlängert, VE= 1 ST</p> <p>Rubber cap for Hysteroscope, long, PACK= 1 PCS</p> 	rotorange / dark orange	18.01

6

Hand Blower
for air insufflation

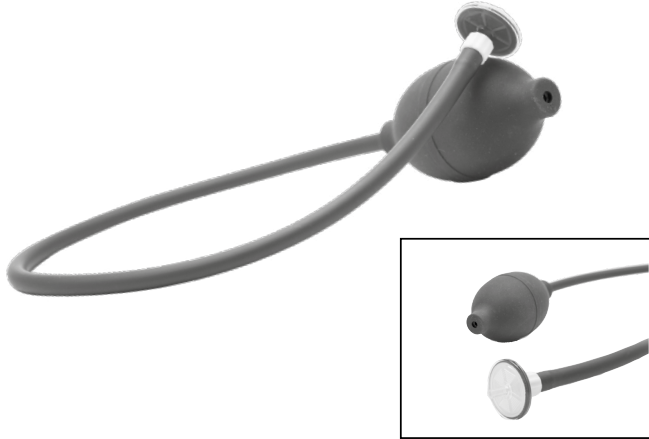
Handgebläse
zur Luftinsufflation

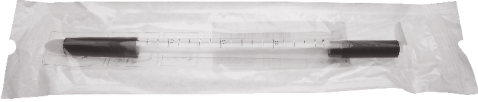
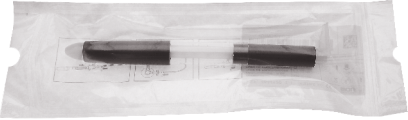
	<p>Applikationen / Applications</p>  <p>Pharynx und Larynx / Thoraskopie <i>Pharynx and Larynx / Thoracoscopy</i></p>  <p>Prokto-Rektoskopie / <i>Procto rectoscopy</i></p>		
	Ø	GL / TL	Type / Type
<p>Handgebläse, mit Filter zum Einmalgebrauch, steril (VE= 5 ST) Hand blower, with filter for single use, sterile (PACK= 5 PCS)</p>	49 mm	567 mm	412700
<p>Rektoskop-Tubus, steril, VE= 10 ST Rectoscope tube, sterile, PACK= 10 PCS</p> 	21 mm	NL / WL 255 mm	4844255
<p>Rektoskoptubus, steril, VE= 10 ST Rectoscope tube, sterile, PACK= 10 PCS</p> 	21 mm	NL / WL 120 mm	4844120

7