



Chirurgisches Nahtmaterial

Surgical suture material

Chirurgisches Nahtmaterial

Surgical Suture Material



- für Praxis und OP
- gezielter Einsatz bei jeder Art von Wundversorgung
- resorbierbares Nahtmaterial unterstützt die natürlichen Reparaturvorgänge
- nicht-resorbierbare Fadenmaterialien garantieren dauerhafte Unterstützung und beste Bioverträglichkeit

- *for practice and surgery*
- *employed specifically in any form of wound care*
- *absorbable suture materials underpin the natural processes of repair*
- *non-absorbable suture materials guarantee lasting support and optimal biocompatibility*



In der Natur müssen verletzte oder zerstörte Gewebeschichten rasch geschlossen werden, um die Integrität und Funktion des Organismus aufrecht zu erhalten. Diese Vorgehensweise hat der Mensch von der Natur übernommen.

Ein Ziel der modernen Wundversorgung ist dabei in erster Linie der Erhalt noch intakter Gewebe und die Unterstützung der geschädigten Bereiche. Unsere Nahtmaterialien auf der Basis bioverträglicher Rohstoffe ermöglichen den gezielten Einsatz bei jeder Art der Wundversorgung und garantieren bestmögliche Gewebeverträglichkeit.

Chirurgisches Nahtmaterial dient als typisches Medizinprodukt zur Reparatur von Geweben. Noch immer werden die meisten Wundverschlüsse mit Nähten ausgeführt. Dabei ist die mechanische Eigenschaft der eingesetzten Materialien von größter Bedeutung, um die verlorene Festigkeit zeitweilig zu ersetzen.

Resorbierbares Nahtmaterial, wie z.B. PGA RESORBA®, unterstützen dabei die natürlichen Reparaturvorgänge, bis Form und Funktion wieder hergestellt sind. Anschließend werden diese im Organismus abgebaut.

Nicht-resorbierbare Fadenmaterialien (z.B. MOPYLEN®) garantieren dauerhafte Unterstützung und beste Bioverträglichkeit, wie sie insbesondere bei Langzeitimplantaten gefordert wird.

In nature, tissue layers that have been damaged or destroyed must be closed promptly to maintain the integrity and normal functioning of the body. Man has adopted this process from nature.

One primary aim of modern wound care is to preserve tissues that are still intact, and to support areas that have been damaged. Our suture products, created from biocompatible starting materials, can be employed specifically in any form of wound care and guarantee the best possible tissue tolerance.

Surgical suture materials are a typical medical product used for repairing tissues. Sutures are still employed for the closure of most wounds. The mechanical properties of suture materials are therefore of great importance if they are to make good the temporary loss of tissue integrity and strength.

Absorbable suture materials such as PGA RESORBA® underpin the natural processes of repair until form and function have been restored. They are then broken down within the body.

Non-absorbable suture materials such as MOPYLEN® guarantee lasting support and optimal biocompatibility, essential requirements for long-term implants.

RESORBA Medical GmbH · Am Flachmoor 16 · 90475 Nürnberg · Germany
Tel. +49 9128 / 91 15 0 · Fax +49 9128 / 91 15 91 · infomail@resorba.com · www.resorba.com



Inhaltsübersicht

Allgemeine Übersicht	Seite
PEEL-eco-Pack	3
Micro-Pack	4
Verpackungen	5
Organisationshilfen	6
Fadentabelle	7
Symbole	8-9
Tipps / Die Nadel	10
Nadel-Daten	11-13
Nadel-Programm	14-18
Materialtabelle	19
Resorption	20

Produktübersicht

- PGA *resoquick*TM
- GLYCOLON®
- PGA RESORBA®
- PDO RESORBATM
- MOPYLEN®
- RESOPREN®
- POLYESTER
- SUPOLENE
- NYLON
- RESOLON®
- SUPRAMID
- SEIDE
- STAHLDRAHT
- RESORBA® OT-Cord
- DENTAL KOMBINATIONEN
- SPEZIALKOMBINATIONEN
- FEDERÖHRNADELN – UNSTERIL / STERIL

Index

General Information	Page
PEEL-eco-Pack	3
Micro-Pack	4
Types of packaging	5
Organizational support	6
Suture Table	7
Symbols	8-9
Tips / The needle	10
Needle data	11-13
Needle range	14-18
Table of materials	19
Absorption	20

Product Range

- PGA *resoquick*TM
- GLYCOLON®
- PGA RESORBA®
- PDO RESORBATM
- MOPYLEN®
- RESOPREN®
- POLYESTER
- SUPOLENE
- NYLON
- RESOLON®
- SUPRAMID
- SILK
- STAINLESS STEEL
- RESORBA® OT-Cord
- DENTAL COMBINATIONS
- SPECIALIST PRODUCTS
- SPRING-EYE-NEEDLES – NON STERILE / STERILE

Peel-eco-Pack

Eine Kombination aus peel-fähiger Umverpackung und multifunktionaler Innenverpackung.
 A combination of peelable outer sachet and multifunctional inner sachet.

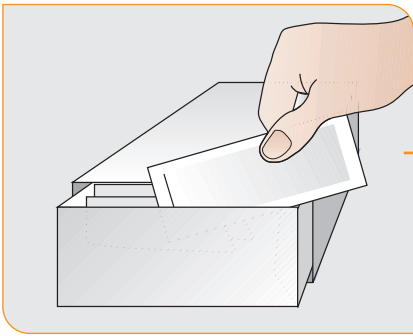

1. Entnahme der Peel-Packung aus dem Vorratskarton.

Remove the peel pack from the storage box.

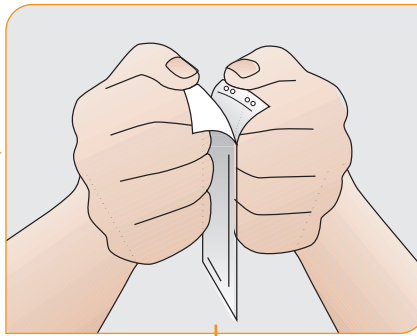

2. Der Springer greift die beiden Aufziehlaschen am oberen Ende der Packung und öffnet diese durch gleichmäßiges Peelen.

The circulating nurse grasps the two tabs at the upper end of the pack and opens them by peeling them apart evenly.



3. Steriler Inhalt wird kontaminationsfrei angereicht.

The sterile contents are passed to the surgeon without contaminating them.

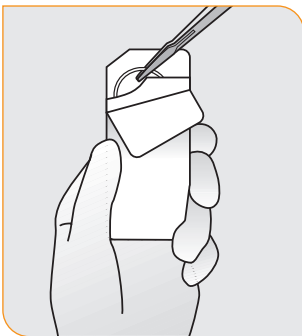

Einzelpack / Nadel-Faden-Kombination

Beim Umklappen der perforierten Lasche wird die Nadel freigelegt. Diese wird anschließend mit dem Nadelhalter entnommen.

Individual pack / needle-thread combination

The needle is exposed by folding back the perforated tab and then withdrawn with the needle holder.

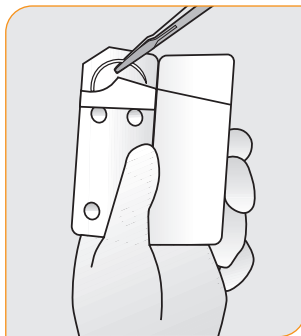

Einzelpack / Nadel-Faden-Kombination

Durch Aufklappen des Fadenträgers wird die Nadel freigelegt. Diese wird anschließend mit dem Nadelhalter entnommen.

Individual pack / needle-thread combination

The needle is exposed by folding out the suture carrier and then withdrawn with the needle holder.

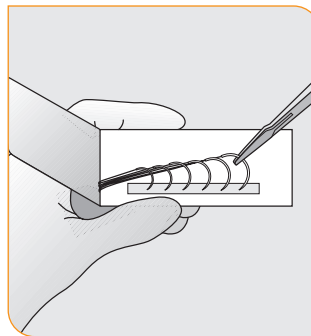

Multipack

Durch seitliches Aufklappen der Papierabdeckung werden die Nadeln freigelegt und anschließend einzeln (nacheinander) mittels Nadelhalter entnommen.

Multi pack

The needles are exposed by folding the paper cover to the side. They are then withdrawn individually (one after another) with the needle holder.

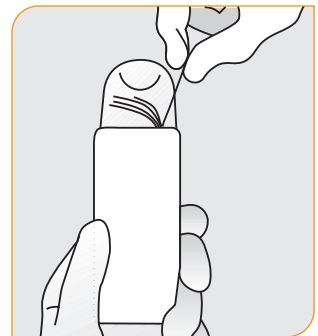

Einzelfadenpackung

Nach Aufklappen der oberen Lasche können die Einzelfäden in beliebiger Reihenfolge entnommen werden.

Pre-cut sutures

After the upper tab has been folded back the individual threads can be withdrawn in any order.

Micro-Pack

Packungen mit Schaumstoff-Trägern für die Mikro- und Augen Chirurgie.
Packs with foam carriers for microsurgery and ophthalmic surgery.

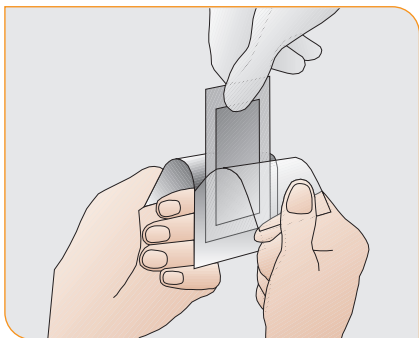

1. Aufpeelen des unsterilen Außenbeutels und kontaminationsfreies Anreichen des sterilen Innenbeutels.

Peel open the unsterile outer sachet and grasp the sterile inner sachet without contaminating it.

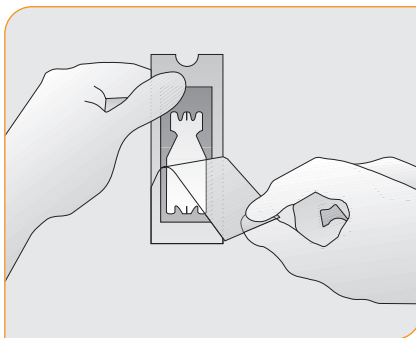

2. Aufpeelen des sterilen Innenbeutels.

Peel open the sterile inner sachet.

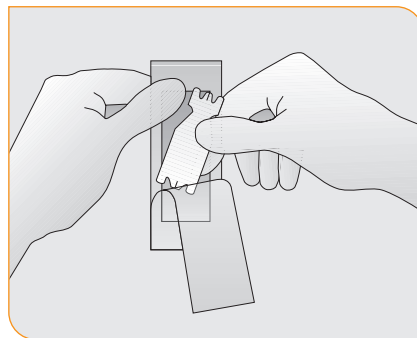

3. Vorsichtige Entnahme des sterilen Fadenträgers aus dem Blisterbeutel.

Carefully remove the sterile suture carrier from the blister.

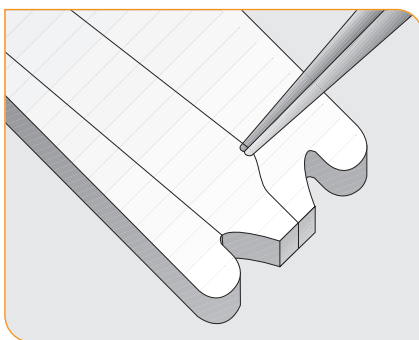

4. Vor Nadelentnahme fixierten Faden mit Pinzette vom Träger lösen.

Before removing the needle, separate the thread from the carrier with forceps.

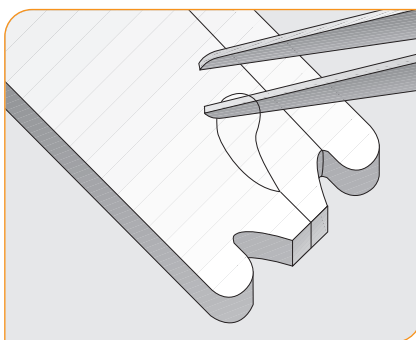

5. Bei doppelt armiertem Faden, erst Fadenschleife lösen bzw. durchtrennen, dann Faden mit Pinzette vom Träger lösen.

In the case of double-armed threads, firstly separate/cut the needle loop and then separate the thread from the carrier with forceps.

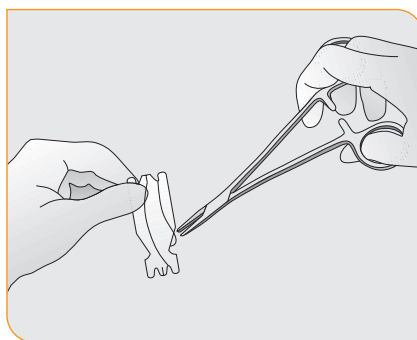

6. Nadel mit Nadelhalter fassen und durch leichtes Drehen vom Träger nehmen.

Grasp the needle with the needle holder and remove it from the carrier by gently rotating it.

7. Während der Operation kann die Nadel im sterilen Träger „geparkt“ werden. Nach der Operation dient der Träger zur Aufnahme und Kontrolle der eingesetzten Nadeln.

During the operation the needle can be „parked“ in the sterile carrier. After the operation the carrier serves as a recipient for checking the number of needles used.

Verpackungen / Types of packaging

Multi-L-Pack Multi-L-Pack

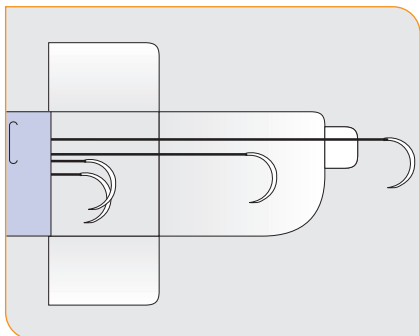

Spezielle Kombinationen werden zur Vermeidung des Memory-Effekts im Multi-L-Pack angeboten. Dieser ermöglicht die problemlose und schnelle Entnahme.

Special combinations are available for preventing the memory effect in the Multi-L-Pack. This ensures rapid, problem-free removal.

Flachspule Dispenser packaging

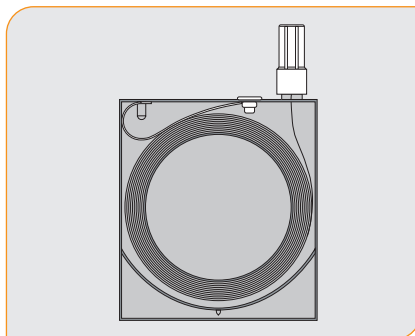

Das Nahtmaterial kann aseptisch aus der Flachspule entnommen werden. Chirurgische Nahtmaterialien in Flachspulen kommen überwiegend in der Veterinärmedizin zum Einsatz. Diese Verpackungsart ist zweckbestimmt sicher und ökonomisch.

Suture material can be removed aseptically from the dispenser. Suture material in so-called suture dispensers is predominantly used in veterinary medicine. The packaging is safe and economical.

Ligatu-Pack Ligature-Pack

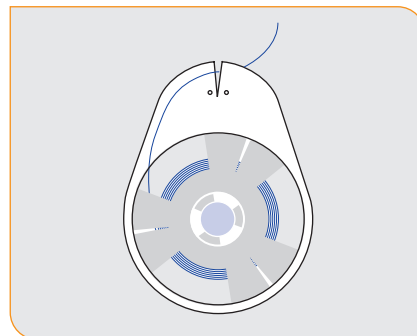

Chirurgisches Nahtmaterial bis zu einer Länge von 4 m kann während der Operation von einer Handrolle entnommen werden.

Suture material of up to 4 m in length can be taken from a hand reel during an operation.

Organisationshilfen / *Organizational support*

Set-Verpackung *Set packs*

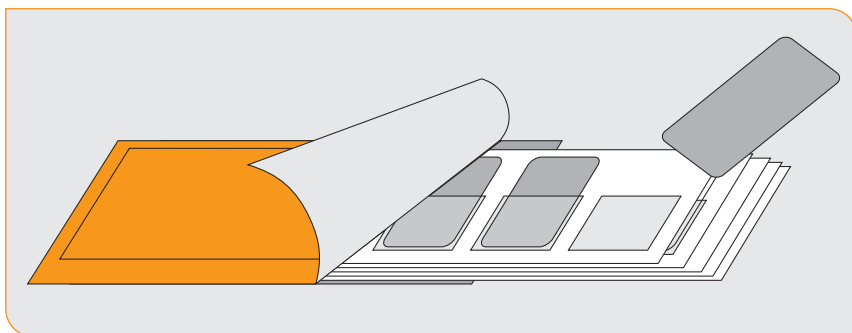

Individuelle Zusammenstellung verschiedener Nahtmaterialien in einem Set nach Ihren indikationsspezifischen Vorgaben über Material, Menge und Reihenfolge.

- Mindestabnahme: produktionsbedingt
- Fertigung ohne Aufpreis
- Beschriftung mit allen relevanten Angaben (Indikation, Inhalt, ...)
- Eine LOT-Nr. für gesamtes Set

Individually tailored combinations of various suture materials in accordance with your indication specific instructions regarding material, amount, and sequence.

- *Minimum purchase: due to production*
- *Prepared at no additional charge*
- *Lettering with all necessary data (indication, content, ...)*
- *Only one LOT-no. for the whole set*

Kombi-Box *Combination Box*

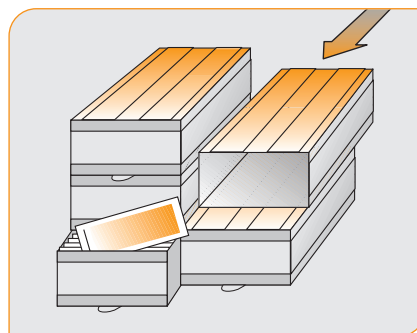

Das Aufbewahrungsmagazin für Standard-Nahtmaterialpackungen zur übersichtlichen Organisation im OP (horizontal / vertikal zusammensteckbar).











The container for storing standard packs of suture materials provides easy access to suture materials in the operating theatre (horizontally and vertically attachable).

Fadentabelle / Suture table

Pt.-Eur.	Durchmesser- spanne in mm Diameter range in mm	PGA RESORBA®	PGA resogquick™	MOPYLEN®	RESOPREN®	POLYESTER	SUPOLENE	NYLON monofil NYLON monofilament	RESOLON®	SUPRAMID	SEIDE SILK	STAHLDRAHT monofil STEEL monofilament	RESORBA® OT-Cord	Synth. monofile Durchm. spanne in mm Synth. monofilament Diameter range in mm	GLYCOLON®	PDO RESORBA™
0.1 EP	0,010-0,019	-	-	-	-	-	-	-	-	-	-	-	-	-	-	-
0.2 EP	0,020-0,029	-	-	10-0	-	-	-	10-0	-	-	-	-	-	-	-	-
0.3 EP	0,030-0,039	-	-	9-0	-	-	-	9-0	-	-	-	-	-	-	-	-
0.4 EP	0,040-0,049	8-0	8-0	8-0	-	-	-	8-0	-	-	8-0	-	-	-	-	-
0.5 EP	0,050-0,069	7-0	7-0	7-0	7-0	-	-	7-0	7-0	-	7-0	-	-	0,050-0,094	-	7-0
0.7 EP	0,070-0,099	6-0	6-0	6-0	6-0	6-0	6-0	6-0	6-0	6-0	6-0	6-0	-	0,095-0,149	6-0	6-0
1 EP	0,100-0,149	5-0	5-0	5-0	5-0	5-0	5-0	5-0	5-0	5-0	5-0	5-0	-	0,150-0,199	5-0	5-0
1.5 EP	0,150-0,199	4-0	4-0	4-0	4-0	4-0	4-0	4-0	4-0	4-0	4-0	4-0	4-0	0,200-0,249	4-0	4-0
2 EP	0,200-0,249	3-0	3-0	3-0	3-0	3-0	3-0	3-0	3-0	3-0	3-0	3-0	3-0	0,250-0,339	3-0	3-0
2.5 EP	0,250-0,299	-	2-0	-	-	-	-	-	-	2-0	-	-	-	-	-	-
3 EP	0,300-0,349	2-0	2-0	2-0	2-0	2-0	2-0	2-0	2-0	2-0	2-0	2-0	2-0	0,340-0,399	2-0	2-0
3.5 EP	0,350-0,399	0	0	0	0	0	0	0	0	0	0	0	0	0,400-0,499	0	0
4 EP	0,400-0,499	1	1	1	1	1	1	1	1	1	1	1	1	0,500-0,570	1	1
5 EP	0,500-0,599	2	2	2	2	2	2	2	-	2	2	2	2	0,571-0,610	-	2
6 EP	0,600-0,699	3+4	-	-	-	3+4	3+4	-	-	-	3+4	3+4	-	-	-	-
7 EP	0,700-0,799	5	-	-	-	5	-	-	-	-	-	5	-	-	-	-
8 EP	0,800-0,899	-	-	-	-	6	-	-	-	-	-	6	-	-	-	-
9 EP	0,900-0,999	-	-	-	-	-	-	-	-	-	-	7	-	-	-	-

Wussten Sie schon? / Do you know?





Kleine Symbollehre für Medizinprodukte Short lesson in symbols used for medical products

	Bestellnummer	Reference number
	Chargenbezeichnung	Batch number
	Verwendbar bis Jahr - Monat - Tag	Use by year - month - day
	Gebrauchsanweisung beachten	Consult instructions for use
	Nicht zur Wiederverwendung	Do not reuse
	Nicht erneut sterilisieren	Do not resterilize
	Bei beschädigter Verpackung nicht verwenden	Do not use if package is damaged
	Sterilisation mit Ethylenoxid	Sterilised using ethylene oxide
	Obere Temperaturbegrenzung	Upper Limit of Temperature
	CE-Kennzeichnung und Kennnummer der benannten Stelle. Das Produkt entspricht den grundlegenden Anforderungen der Richtlinie des Rates über Medizinprodukte 93/42/EWG	CE mark and identification Number of the Notified Body. Product conforms to the essential requirements of the Medical Device Directive 93/42/EEC
	HIBC-Code	HIBC-Code

Symbolerklärungen zur Chemischen Zusammensetzung synthetischen Nahtmaterials Explanation of symbols used for the chemical composition of synthetic sutures

PGA-PCL	GLYCOLON®	Poly(Glycolide-Co-Caprolactone)	Poly(glycolide-co-caprolactone)
PGA	PGA <i>resoquick</i> ™	Polyglykolsäure	Polyglycolic acid
PGA	PGA <i>RESORBA</i> ®	Polyglykolsäure	Polyglycolic acid
PDO	PDO <i>RESORBA</i> ™	Poly(P-Dioxanon)	Poly(p-dioxanone)
PP	MOPYLEN®	Polypropylen	Polypropylene
PVDF	RESOPREN®	Polyvinylidendifluorid	Polyvinylidene difluoride
PET	POLYESTER	Polyester	Polyester
PET	SUPOLENE	Polyester	Polyester
PA	NYLON	Polyamid	Polyamide
PA	RESOLON®	Polyamid	Polyamide
PA	SUPRAMID	Polyamid	Polyamide
UHMWPE	<i>RESORBA</i> ® OT-Cord	Ultrahochmolekulargewichtiges Polyethylen	Ultra High Molecular Weight Poly-Ethylene

Symbolerklärungen / Explanation of Symbols





	Abziehnadel <i>control release needle</i>		Schlingennaht <i>loop suture</i>
	Schlinge <i>loop</i>		Ligaturpack/-spule <i>ligature pack</i>

Materialsymbole auf der Verpackung

Symbols used on packaging





Resorbierbares Nahtmaterial

absorbable suture material

	gefärbt / geflochten / beschichtet / resorbierbar	<i>dyed / braided / coated / absorbable</i>	PGA RESORBA®
	gefärbt / monofil / resorbierbar	<i>dyed / monofilament / absorbable</i>	PDO RESORBA™, GLYCOLON®*
	ungefärbt / geflochten / beschichtet / resorbierbar	<i>undyed / braided / coated / absorbable</i>	PGA RESORBA®, PGA resoquick™
	ungefärbt / monofil / resorbierbar	<i>undyed / monofilament / absorbable</i>	PDO RESORBA™, GLYCOLON®

Nicht-resorbierbares Nahtmaterial

non-absorbable suture material

	gefärbt / geflochten / beschichtet / nicht-resorbierbar	<i>dyed / braided / coated / non-absorbable</i>	SUPRAMID*, SUPOLENE, POLYESTER, SEIDE SILK
	gefärbt / monofil / nicht-resorbierbar	<i>dyed / monofilament / non-absorbable</i>	MOPYLEN®, RESOPREN®, SUPRAMID, NYLON, RESOLON®
	ungefärbt / geflochten / beschichtet / nicht-resorbierbar	<i>undyed / braided / coated / non-absorbable</i>	SUPRAMID, SUPOLENE, POLYESTER
	weiß / geflochten / nicht-resorbierbar	<i>white / braided / non-absorbable</i>	RESORBA® OT-Cord
	ungefärbt / monofil / nicht-resorbierbar	<i>undyed / monofilament / non-absorbable</i>	SUPRAMID, NYLON, STAHLDRAHT STAINLESS STEEL

* auch als Oral-Variante erhältlich

Tipps (Warnhinweise) / Suggestions

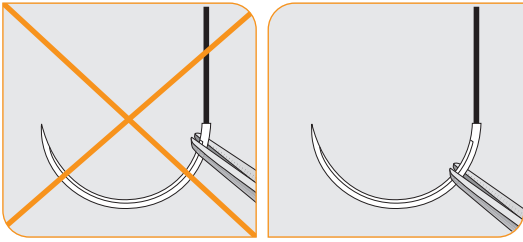

Nadel fassen

Die Nadeln sollen in einer Distanz von ca. 3/4, von der Nadelspitze aus gesehen, gefasst werden. Nicht an der Armierungszone fassen, damit diese und auch der Faden nicht verletzt werden.

Holding the needle

Needles should be held approx. 3/4 away from the tip. Do not clamp where the suture is swaged to the needle to avoid weakening the needle and suture.

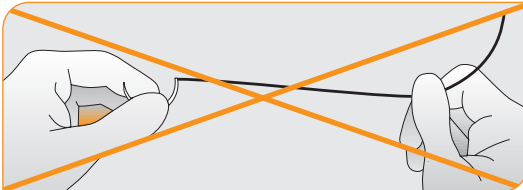

Faden strecken

Faden nach Herausnahme vorsichtig strecken! Nicht schnell ziehen oder reiben; nicht an der Nadel fassen und strecken!

Straightening the suture

Straighten the suture gently after removal. Do not rub it or pull it quickly. Do not hold the needle and stretch!

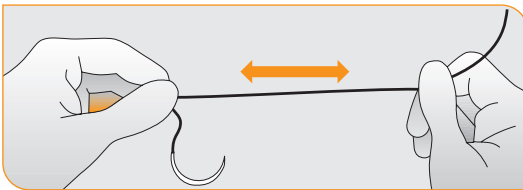

Die Nadel / The needle

Dürfen wir vorstellen: Die chirurgische Nadel!
May we introduce: The surgical needle!

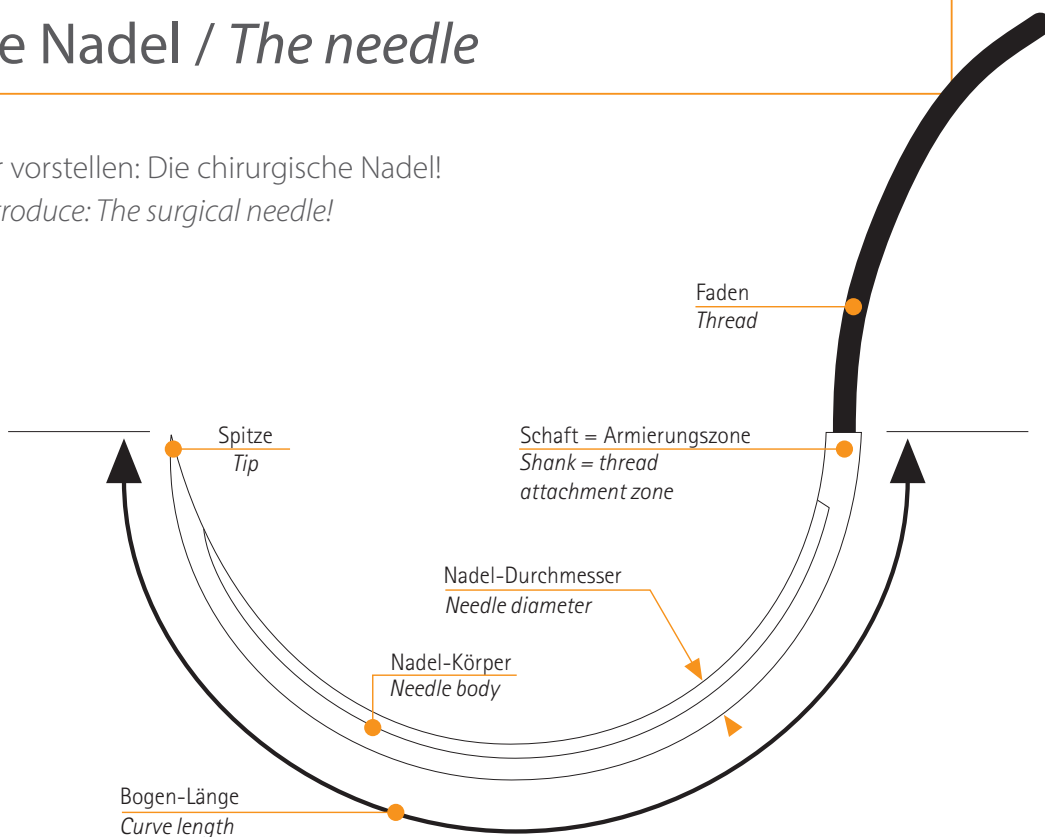

Nadelcode / Needle code

<p>H R X 30</p>	<p>1. Buchstabe: Gibt die Nadelkrümmung an</p> <p>F = 5/8-kreisförmig H = 1/2-kreisförmig D = 3/8-kreisförmig V = 1/4-kreisförmig K = 1/2-kreis/kufenförmig A = Asymptotisch G = Gerade</p>	<p>1st letter: Indicates the curvature of the needle</p> <p>F = 5/8 circle H = 1/2 circle D = 3/8 circle V = 1/4 circle K = semicurved A = asymptotic G = straight</p>
	<p>2. Buchstabe: Gibt Auskunft über die Ausführung des Nadelkörpers und der Spitze</p> <p>R = Rundkörper-Nadel S = Schneidende Nadel (außen)</p>	<p>2nd letter: Gives information on the type of needle and needle tip</p> <p>R = round bodied needle S = reverse cutting needle</p>
	<p>3.+4. Buchstabe: Bezeichnet die Sonderformen des Nadelkörpers und der Spitze</p> <p>I = innen schneidend M = PREMIUM-Schliff (z.T. Handschliff) N = Stumpfe Spitze T = Schneidende Spitze (DIAMOND) P = Spatula-Nadel (PREMIUM/DIAMOND) S = stärkerer Durchmesser X = extra starker Durchmesser F = feiner PREMIUM-Schliff "THIN LINE" (z.T. Handschliff) W = biegsame Nadel</p>	<p>3rd and 4th letters: Describe special features of the needle and needle tip</p> <p>I = conventional cutting M = PREMIUM cut (partly hand-honed) N = blunt point T = trocar point P = spatulated needle S = stronger diameter X = extra strong diameter F = thin PREMIUM cut "THIN LINE" (partly hand-honed) W = flexible needle</p>
<p>Zahlen geben gestreckte Länge der Nadel (Bogenlänge) in Millimeter an</p> <p>S (nach Zahlen) = stärkerer Durchmesser F (nach Zahlen) = extra feiner Durchmesser</p>	<p>Numbers indicate the straight (extended) length of the needle in millimeters</p> <p>S (after numbers) = stronger diameter F (after numbers) = extra thin diameter</p>	

Nadelkrümmung / Needle curvature

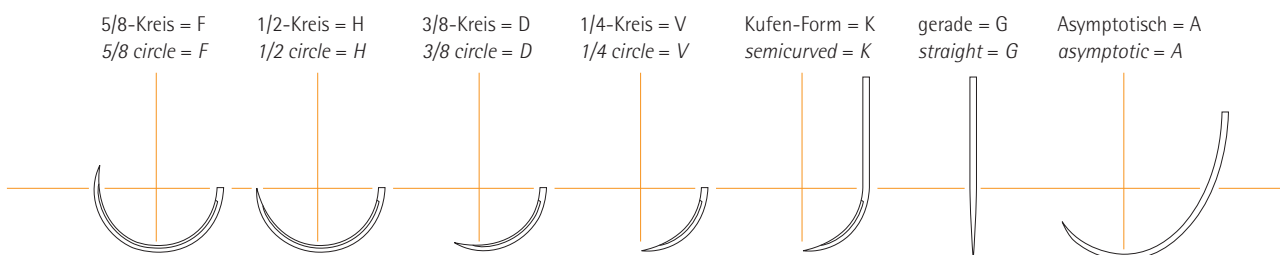

Nadelformen / Needle shapes

1. Spatula Nadel ◻ = P

1/2-, 3/8-, 1/4-kreisförmig oder gerade = HSPM, DSPM, VSPM

- Für Augen- und Mikrochirurgie
- Abgeflachter Nadelkörper
- PREMIUM-Schliff
- Seitlich schneidend

1. Spatula needle ◻ = P

1/2 circle, 3/8 circle, 1/4 circle, or straight = HSPM, DSPM, VSPM

- For use in ophthalmic surgery and microsurgery
- Needle cross-section flattened
- PREMIUM cut
- Cuts on lateral edges

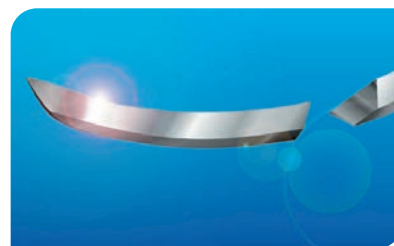

2. Stumpfe Rundkörpernadel ○ = RN

1/2-, 3/8- kreisförmig oder 1/2-gebogen = HRN, DRN, KRN

- Für Parenchymgewebe, Cervix und Muskelzüge am Auge
- Stumpfe Nadelspitze
- Kein Durchstechen von Gefäßen oder Sehnen

2. Blunt round-bodied needle ○ = RN

1/2 circle, 3/8 circle or semicurved = HRN, DRN, KRN

- For use in parenchymal tissue, the cervix, and muscle traction in the eye
- Needle tip blunt
- No puncturing of vessels or tendons



3. Außen schneidende Nadel ▼ = S

1/2-, 3/8-kreisförmig, 1/2-gebogen oder gerade = HS, DS, KS, GS

- Für festes Gewebe, wie z.B. Haut
- Dreieckiger Nadelquerschnitt
- z.T. mit PREMIUM-Schliff M

3. Reverse cutting needle ▼ = S

1/2 circle, 3/8 circle, semicurved or straight = HS, DS, KS, GS

- For use in firm tissue such as skin
- Triangular needle cross-section
- Also available with PREMIUM cut needles M

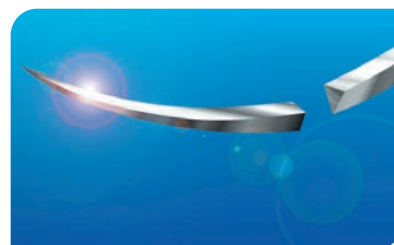

4. Innen schneidende Nadel ▲ = SI

1/2-, 3/8-kreisförmig = HSI, DSI, FSI

- Für festes Gewebe, wie z.B. Haut
- Dreieckiger Nadelquerschnitt
- z.T. mit PREMIUM-Schliff M

4. Inner cutting needle ▲ = SI

1/2 circle, 3/8 circle = HSI, DSI, FSI

- For use in firm tissue such as skin
- Triangular needle cross-section
- Also available with PREMIUM cut needles M



5. Rundkörpernadel ● = R

5/8-, 1/2-, 3/8-kreisförmig oder gerade = FR, HR, DR, GR

- Für weiches Gewebe (subcutan), wie Muskel, Faszie, Schleimhaut
- Zum besseren Sitz des Nadelhalters ist der Nadelkörper im mittleren Bereich abgeflacht
- Leichter Einstich

5. Round-bodied needle ● = R

5/8 circle, 1/2 circle, 3/8 circle or straight = FR, HR, DR, GR

- For use in soft tissue (subcutaneous) such as muscle, fascia, mucosa
- In order to improve grip by the needle holder, the cross-section of the middle part of the needle is flattened
- Easy insertion



6. Schneidende Rundkörpernadel

◻ = RT

1/2-, 3/8-kreisförmig oder gerade = HRT, DRT, GRT, ART

- Für festes Gewebe, sklerotische Gefäße und Prothesen
- Nadelspitze dreikantig geschliffen

6. Round-bodied cutting needle

◻ = RT

1/2 circle, 3/8 circle or straight = HRT, DRT, GRT, ART

- For use in firm tissue, sclerotic vessels, and implants
- Needle tip triangular in section



Nadelfolie / Needle foil

Zur Identifizierung atraumatischer Nadeln

Die Nadelfolie erleichtert die Einordnung von chirurgischen Nadeln hinsichtlich Länge und Form. Legen Sie die Folie des Nadelprogramms über die zu bestimmende Nadelab- bildung und lesen Sie die technischen Daten über den europäischen Nadelcode ab.

Foil for identifying atraumatic needles

The foil enables the length and shape of any needle to be identified. Place the foil showing the range of needles over the needle you like to identify and read off the corresponding technical data and European code.

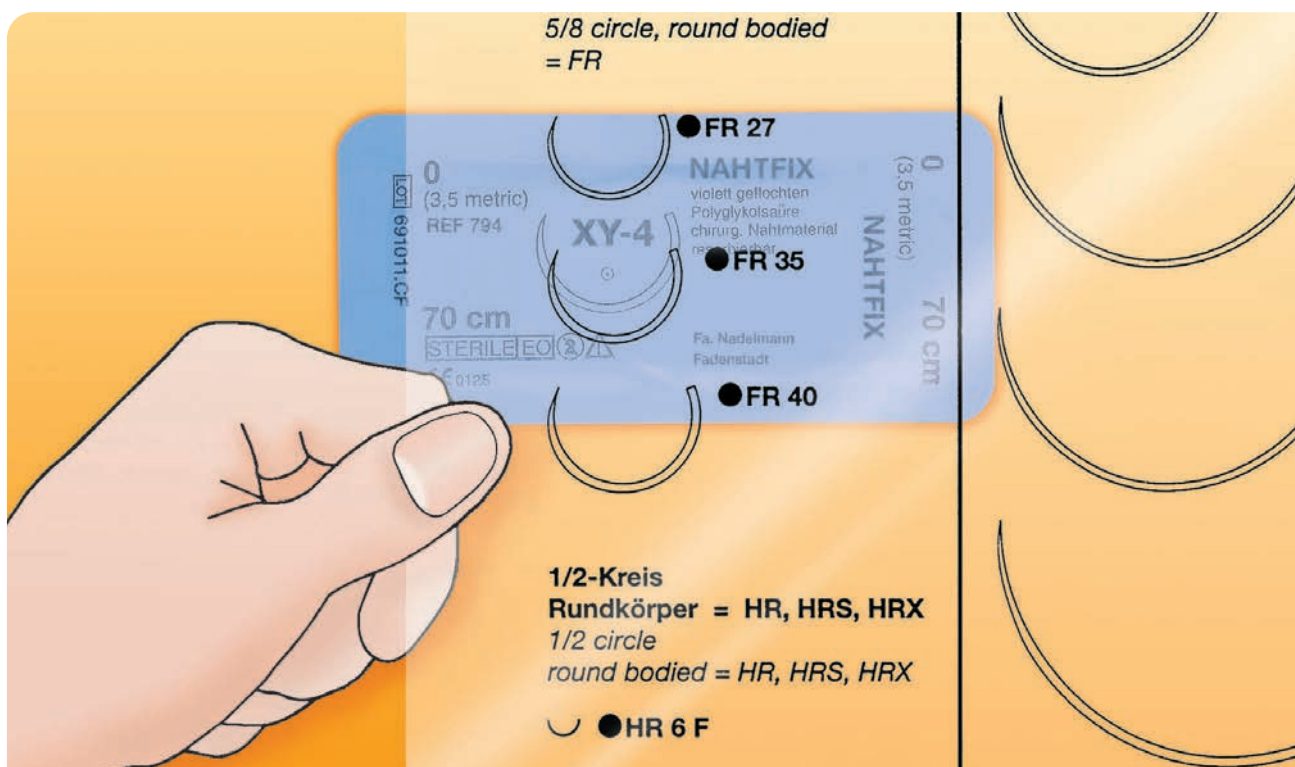

Nadel-Programm / Needle range

FR = 5/8-Kreis Rundkörper

FR = 5/8 circle, taper point

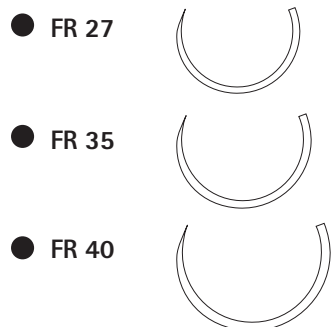

HR, HRS, HRX = 1/2-Kreis Rundkörper

HR, HRS, HRX = 1/2 circle, taper point

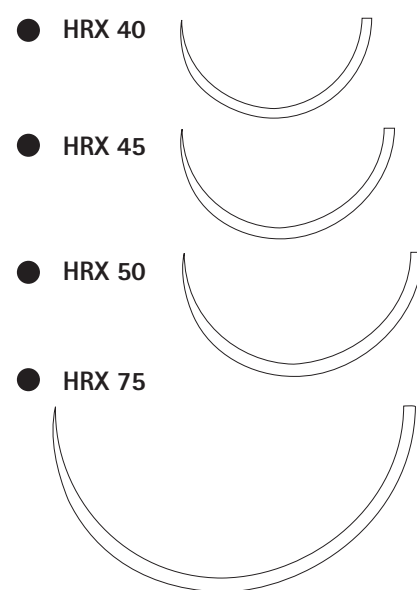
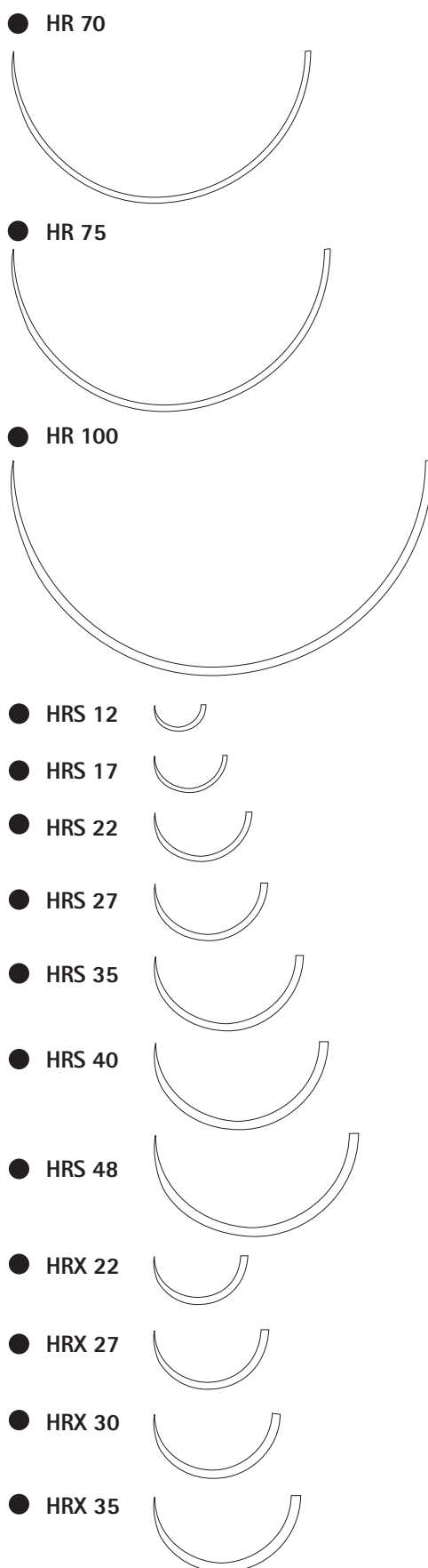
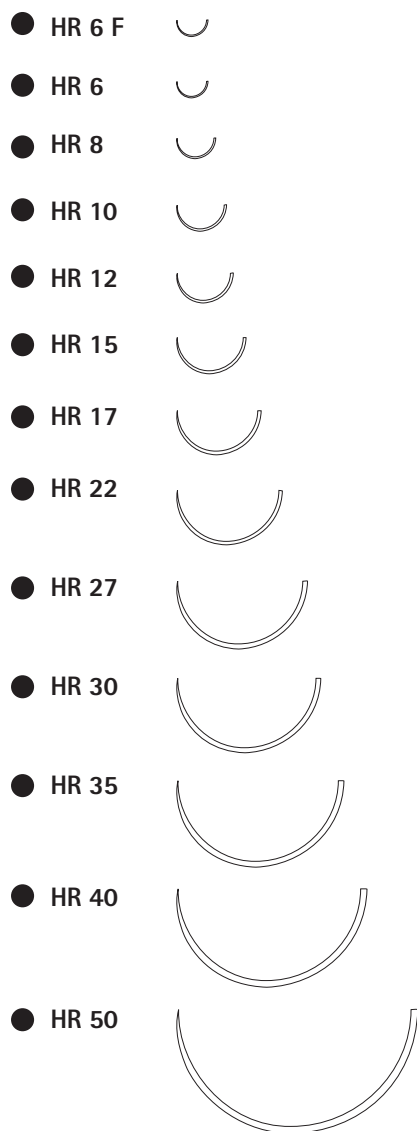

HRN = 1/2-Kreis Rundkörper stumpf

HRN = 1/2 circle, blunt taper point

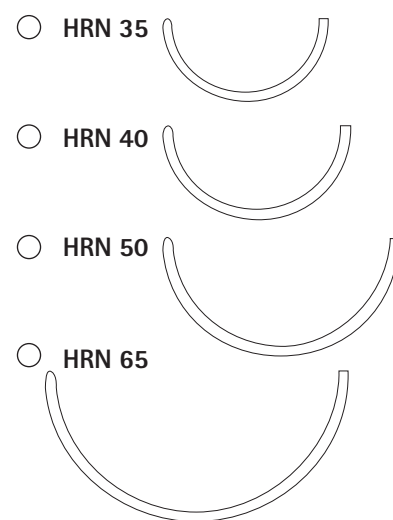

ART = Asymptotische schneidende Rundkörper



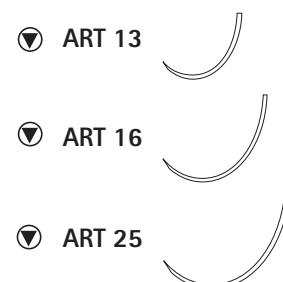









ART = asymptotic, taper cutting



Nadel-Programm / Needle range







HRT, HRTX = 1/2-Kreis schneidende Rundkörper (Diamond-Spitze)







HRT, HRTX = 1/2 circle, taper cutting

- ▼ HRT 13 
- ▼ HRT 16 
- ▼ HRT 18 
- ▼ HRT 22 
- ▼ HRT 25 
- ▼ HRT 30 
- ▼ HRT 35 
- ▼ HRT 40 
- ▼ HRT 45 
- ▼ HRT 50 
- ▼ HRTX 45 
- ▼ HRTX 50 

DR = 3/8-Kreis Rundkörper



DR = 3/8 circle, taper point

- DR 4 
- DR 5 F 
- DR 5 
- DR 6 
- DR 8 
- DR 10 F 

- DR 10 
- DR 12 F 
- DR 12 
- DR 18 
- DR 20 
- DR 30 







DRN = 3/8-Kreis Rundkörper stumpf

DRN = 3/8 circle, blunt taper point

- DRN 17 
- DRN 64 & 65 

DRT = 3/8-Kreis schneidende Rundkörper (Diamond-Spitze), DRTM = mit PREMIUM-Schliff

*DRT = 3/8 circle, taper cutting,
DRTM = with PREMIUM cut*

- ▼ DRT 12 
- ▼ DRT 18 
- ▼ DRT 25 
- ▽ DRTM 5 
- ▽ DRTM 6 
- ▽ DRTM10 
- ▽ DRTM 12 

Nadel-Programm / Needle range

HS = 1/2-Kreis außen schneidend

HS = 1/2 circle, reverse cutting

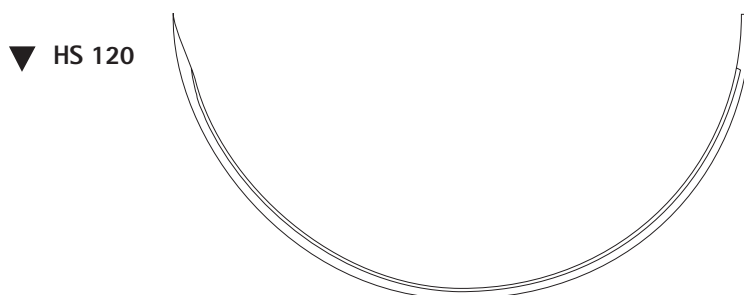
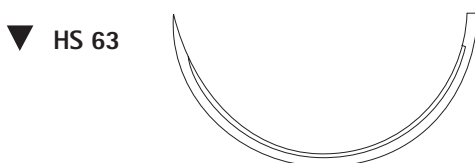

Nadel-Programm / Needle range

HSX = 1/2-Kreis außen schneidend, extra stark

HSX = 1/2 circle, reverse cutting, extra strong



HSM = 1/2-Kreis außen schneidend mit PREMIUM-Schliff

HSM = 1/2 circle, reverse cutting, with PREMIUM cut

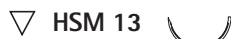

**DS = 3/8-Kreis außen schneidend
DSM = mit PREMIUM-Schliff**

*DS = 3/8 circle, reverse cutting
DSM = PREMIUM cut*

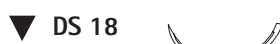

**PREMIUM-Schliff
PREMIUM cut**

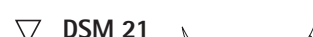
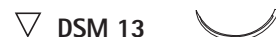
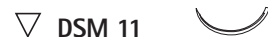
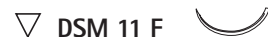

DSI = 3/8-Kreis innen schneidend

DSI = 3/8 circle, conventional cutting



Nadel-Programm / Needle range

GR = Gerade Rundkörper

GR = straight, taper point

● GR 20



● GR 22

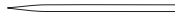

● GR 45



● GR 51



● GR 65



● GRW 65



biegsame Nadel / flexible needle

GRT = Gerade schneidende Rundkörper (Diamond-Spitze)

GRT = straight, taper cutting

▼ GRT 40



GS = Gerade schneidend

GS = straight, cutting

▼ GS 12



▼ GS 25



▼ GS 45



▼ GS 50



▼ GS 60



GSPM = Gerade SPATULA (PREMIUM-Schliff)

GSPM = straight, spatulated
(PREMIUM cut)

▽ GSPM 16



HSPM = 1/2-Kreis SPATULA (PREMIUM-Schliff)

HSPM = 1/2 circle, spatulated
(PREMIUM cut)

▽ HSPM 5 P (progressive Kurve) (progressive curve)

▽ HSPM 6 F

▽ HSPM 6

▽ HSPM 7

▽ HSPM 8

DSPM = 3/8-Kreis SPATULA (PREMIUM-Schliff)

DSPM = 3/8 circle, spatulated
(PREMIUM cut)

▽ DSPM 4

▽ DSPM 5

▽ DSPM 6

▽ DSPM 7

▽ DSPM 8

▽ DSPM 11

VSPM = 1/4-Kreis SPATULA (PREMIUM-Schliff)

VSPM = 1/4 circle, spatulated
(PREMIUM cut)

▽ VSPM 6 F

▽ VSPM 6

▽ VSPM 7

▽ VSPM 8 F

▽ VSPM 8

▽ VSPM 9

KS = 1/2-gebogene außen schneidend

KS = 1/2 curved, reverse cutting

▼ KS 20



Materialtabelle / Table of materials

Bezeichnung Trade name	Grundstoff Raw material	Struktur Structure	Fadenstärke Thread diameter metric	Fadenstärke Thread diameter USP	Farbe Colour	Resorptionsprofil Absorption profile
PGA <i>resoquick</i> ™	Polyglykolsäure, beschichtet <i>Polyglycolic acid, coated</i>	multifil/geflochten <i>multifilament/braided</i>	0.4 bis/to 5 metric	USP 8-0 bis/to 2	ungefärbt <i>undyed</i>	kurzfristig <i>short term</i>
GLYCOLON®	Polyglykolsäure-Caprolacton <i>Polyglycolic acid-caprolactone</i>	monofil <i>monofilament</i>	0.7 bis/to 4 metric	USP 6-0 bis/to 1	violett, ungefärbt <i>violet, undyed</i>	kurzfristig <i>short term</i>
PGA RESORBA®	Polyglykolsäure, beschichtet <i>Polyglycolic acid, coated</i>	multifil/geflochten <i>multifilament/braided</i>	0.4 bis/to 7 metric	USP 8-0 bis/to 5	violett, ungefärbt <i>violet, undyed</i>	mittelfristig <i>mid term</i>
PDO RESORBA™	Poly(P-Dioxanon) <i>Poly(p-dioxanone)</i>	monofil <i>monofilament</i>	0.5 bis/to 5 metric	USP 7-0 bis/to 2	violett, ungefärbt <i>violet, undyed</i>	langfristig <i>long term</i>
MOPYLEN®	Polypropylen <i>Polypropylene</i>	monofil <i>monofilament</i>	0.2 bis/to 5 metric	USP 10-0 bis/to 2	blau <i>blue</i>	
RESOPREN®	PVDF	monofil <i>monofilament</i>	0.5 bis/to 5 metric	USP 7-0 bis/to 2	blau <i>blue</i>	
POLYESTER	Polyester, beschichtet <i>Polyester, coated</i>	multifil/geflochten <i>multifilament/braided</i>	0.7 bis/to 8 metric	USP 6-0 bis/to 6	grün, weiß <i>green, white</i>	
SUPOLENE	Polyester, beschichtet <i>Polyester, coated</i>	multifil/geflochten <i>multifilament/braided</i>	0.7 bis/to 6 metric	USP 6-0 bis/to 3	grün, weiß <i>green, white</i>	
NYLON RESOTEX® ORAL	Polyamid <i>Polyamide</i>	monofil <i>monofilament</i>	0.2 bis/to 5 metric 0.5 bis/to 1.5 metric	USP 10-0 bis/to 2 USP 7-0 bis/to 4-0	schwarz, weiß <i>black, white</i>	
RESOLON®	Polyamid <i>Polyamide</i>	monofil <i>monofilament</i>	0.5 bis/to 4 metric	USP 7-0 bis/to 1	blau <i>blue</i>	
SUPRAMID	Polyamid <i>Polyamide</i>	pseudomonofil <i>pseudomonofilament</i>	0.7 bis/to 5 metric	USP 6-0 bis/to 2	schwarz, weiß <i>black, white</i>	
SEIDE SILK	Seidenfibroin <i>Silk fibroin</i>	multifil/geflochten <i>multifilament/braided</i>	0.4 bis/to 6 metric	USP 8-0 bis/to 3	schwarz <i>black</i>	
STAHLDRAHT STAINLESS STEEL	Stahldraht <i>Stainless steel</i>	monofil <i>monofilament</i>	0.7 bis/to 9 metric	USP 6-0 bis/to 7	natur <i>nature</i>	
RESORBA® OT-Cord	Ultrahochmolekulargewichtiges Polyethylen <i>Ultra High Molecular Weight Poly-Ethylene</i>	multifil/geflochten <i>multifilament/braided</i>	1.5 bis/to 5 metric	USP 4-0 bis/to 2	weiß <i>white</i>	

Resorption / Absorption

Resorbierbare Nahtmaterialien

adaptieren das Gewebe während der Heilungsphase und verlieren dabei zunehmend ihre Zugfestigkeit und Reißkraft. Resorbierbares Nahtmaterial wird durch körpereigene proteolytische Enzyme oder durch Hydrolyse (bei PGA RESORBA®, PGA resoquick™, PDO RESORBA™ und GLYCOLON®) abgebaut.

Nicht-resorbierbares Nahtmaterial

bleibt bei versenkten Nähten im Körpergewebe nahezu unverändert und wird vom Organismus in das umliegende Gewebe eingebaut (abgekapselt). Das für Hautnähte angewandte Fadenmaterial wird, sobald die Festigkeit des Narbengewebes die Wundränder ausreichend zusammenhält, vom Arzt entfernt (üblich nach 7-14 Tagen). Innerhalb des Abbauprozesses unterscheidet man folgende Stadien:

Resorptionszeit

Zeit, in der der Faden 50 % seiner Knotenreißkraft verliert.

Massenresorption

Zeitraum bis zur völligen Auflösung des Fadenmaterials im Gewebe.

Verfallszeit

Zeit, in der ein grundsätzlich nicht-resorbierbares Fadenmaterial durch Degradation in (kleinere) Bruchstücke

zerfällt und somit gleichfalls an Festigkeit verliert (z.B. Polyamide).

Resorptionseigenschaften

Unterschiedliche Indikationen erfordern auch ein unterschiedliches Reißkraft- und Resorptionsverhalten. Diese definierten Fadeneigenschaften können durch die Wahl des Materials sowie modifizierte Herstellungsprozesse erreicht werden. Neben dem kurz-, mittel- oder langfristigen Reißkraftverlust erfolgt auch die entsprechende zeitlich bestimmte Resorption. Das Fadenmaterial erfüllt seine eigentliche Aufgabe nur, solange die gewünschte Reißkraft vorhanden ist.

Absorbable sutures

approximate the tissues during the healing process. During this time the suture's tensile strength will gradually diminish. Absorbable suture material is metabolised by endogenous proteolytic enzymes or by hydrolysis (in the case of PGA RESORBA®, PGA resoquick™, PDO RESORBA™ and GLYCOLON®).

Non-absorbable sutures

remain almost unchanged when placed within body tissues and is encapsulated within the wound scar tissue by the organism. The sutures used for skin closure are removed once the scar tissue has become sufficiently firm to

hold the wound edges together (usually after 7 – 14 days).

It has to be distinguished as follows:

Absorption time

The period in which the suture loses 50 % of its knot tensile strength.

Disintegration

The period during which essentially non-absorbable suture break down by degradation into (smaller) pieces and thus losing its strength (e.g. polyamide).

Dissolution

The period during which the suture completely dissolves within the tissue.

Characteristics of absorption

Different indications also require different tensile strengths and absorption characteristics. These particular features of different sutures can be achieved by the choice of the material and modifying the production process. In addition to the immediate, moderately quick or delayed loss of tensile strength there is also the corresponding duration of absorption. Any given thread material can only fulfil its purpose as long as it has the desired tensile strength.

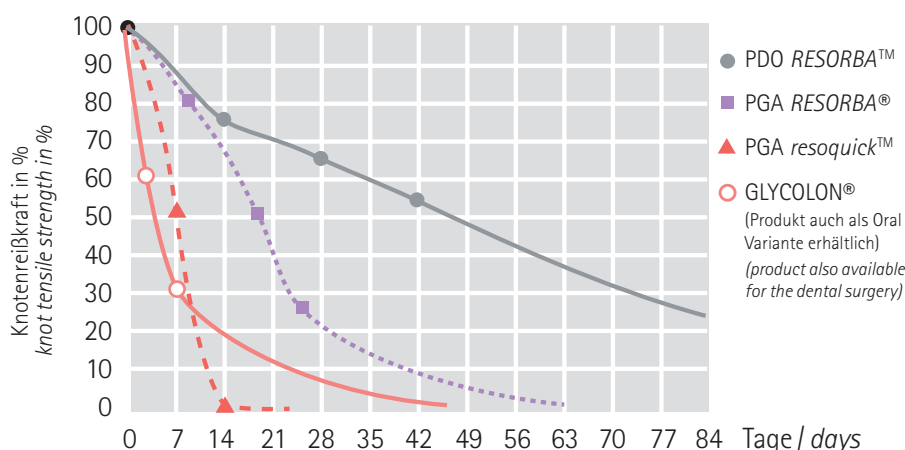

In-vitro-Degradationsversuch: Messung der Knotenreißkraft von GLYCOLON®, PGA resoquick™, PGA RESORBA® und PDO RESORBA™. Nahtmaterial der Stärke 3-0 USP bzw. 2 metric.

In-vitro trial of suture degradation by measuring the knot tensile strengths of GLYCOLON®, PGA resoquick™, PGA RESORBA® and PDO RESORBA™. Suture size: 3-0 USP (2 metric).



- kurzfristig resorbierbares Multifilament
- hohe Reißkraft
- minimales Gewebetrauma
- glatter Gewebedurchzug
- guter Knotensitz

- *short term absorbable multifilament*
- *high tensile strength*
- *minimized tissue trauma*
- *smooth tissue passage*
- *perfect knot security*

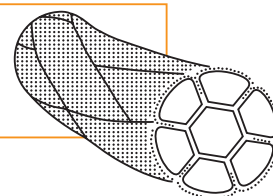

Eigenschaften:

- sehr geschmeidig
- hohe Reißkraft
- guter Knotensitz
- atraumatischer Gewebedurchzug
- moderate Gewebereaktion

PGA resoquick™ ist ein lineares Homopolymer der Glykolsäure (Hydroxyessigsäure) mit hohem Molekulargewicht, das zu Fäden extrudiert und zu Nähten verschiedener Durchmesser geflochten wird. Die Metabolisierung des PGA-Fadenmaterials im Gewebe erfolgt durch die Aufnahme von Wasser, sodass die Synthese umgekehrt wird. Die monomere Glykolsäure wird durch

den normalen Stoffwechsel mittels Enzymen in CO₂ und H₂O gespalten. Die feinen, präzisionsgeflochtenen Fäden gewähren eine sehr hohe Reißfestigkeit sowie ausgezeichnete Handlingeigenschaften. Die spezielle Beschichtung aus einem Gemisch aus Kalziumstearat und Polycaprolacton überzieht die Faserbündel in einer dünnen Schicht, sodass die Oberflächenreibung verringert wird. Resorbierbare Nahtmaterialien adaptieren das Gewebe während der Heilungsphase und verlieren dabei zunehmend ihre Zugfestigkeit und Reißkraft. Die präzisionsgeflochtenen Fäden aus Polyglykolsäure, aus denen PGA resoquick™ besteht, gewährleisten eine standardisierte und mäßig schnelle Resorption im Gewebe. PGA resoquick™ wird schneller als PGA RESORBA® resorbiert, da dieses Material unter Verwendung eines PGA-Materials mit niedrige-

rem Molekulargewicht hergestellt wird. Das Molekulargewicht des PGA-Materials wird während eines speziellen Wärmebehandlungsprozesses des Fadens verringert, bevor die Beschichtung aufgetragen wird. Nach nur sieben Tagen hat PGA resoquick™ bereits 50 % seiner ursprünglichen Reißkraft verloren. Nach 14 Tagen ist keine messbare Reißkraft mehr vorhanden. Die Resorption von PGA resoquick™ ist nach ca. 42 Tagen abgeschlossen.

- ➔ Farbe: ungefärbt
- ➔ Chemische Bezeichnung: Polyglykolsäure
- ➔ Fadenstärke: USP 8-0 -2 (0.4 - 5 metric)
- ➔ Konfektionsangebote:
 - Nadel-Faden-Kombinationen
 - in vorgeschrittenen Längen
- ➔ Sterilisation: Ethylenoxid

Properties:

- very supple
- very high tensile strength
- minimal tissue reaction
- smooth passage through tissue
- high knot security

PGA resoquick™ is a high molecular weight, linear homopolymer of glycolic acid (hydroacetic acid), which is extruded into thin filaments and braided into sutures of various diameters.

Metabolisation of the PGA suture within the tissue occurs by the uptake of water, thus reversing the













synthesis. The monomeric glycolic acid is split enzymatically into CO₂ and H₂O by the normal metabolism. The fine, precision braided filaments guarantee a very high tensile strength as well as great suppleness. The special coating of a mixture of calcium stearate & polycaprolactone thinly covers the fibre bundles for specific reduction of surface friction. Absorbable suture approximates the tissue during the healing phase and progressively loses its tensile strength and breaking load. The precision braided filaments of polyglycolic acid that make up PGA resoquick™ ensure standardized and moderately rapid absorption in tissue. PGA resoquick™ is absorbed rather quickly than PGA RESORBA® because this material is manufactured using a lower molecular weight

PGA. The molecular weight of the PGA material is reduced during a special heat treatment process of the thread before coating. After only seven days PGA resoquick™ has already lost 50% of its original breaking load. After 14 days all original breaking load is lost completely. Absorption of PGA resoquick™ is approximately completed after 42 days.

- ➔ Colour: undyed
- ➔ Chemical name: polyglycolic acid
- ➔ Thread diameter: USP 8-0 -2 (0.4 - 5 metric)
- ➔ Types of packaging:
 - needle-thread-combinations
 - precut lengths
- ➔ Sterilization method: ethylene oxide









PGA resoquick™

Sterile Nadel-Faden-Kombination / *needle suture combination, sterile*

Nadel / needle	Stärke / gauge		Länge / length (m)	Farbe / colour	Best.-Nr. / code no.	Packungsinhalt / box content (Stück / pieces)
	USP	metric				
FR = 5/8-Kreis Rundkörper <i>FR = 5/8 circle, taper point</i>						
FR 27 ● 	3-0	2	0,70	ungefärbt / undyed	PRN30105	24
FR 35 ● 	3-0	2	0,70	ungefärbt / undyed	PRN30104	24
	2-0	3	0,70	ungefärbt / undyed	PRN30103	24
HR, HRS = 1/2-Kreis Rundkörper <i>HR, HRS = 1/2 circle, taper point</i>						
HR 13 ● 	5-0	1	0,70	ungefärbt / undyed	PRN30223	24
HR 17 ● 	5-0	1	0,45	ungefärbt / undyed	PRN30222	24
	5-0	1	0,70	ungefärbt / undyed	PRN30203	24
	4-0	1.5	0,70	ungefärbt / undyed	PRN30204	24
	3-0	2	0,70	ungefärbt / undyed	PRN30205	24
HR 17 F ● 	4-0	1.5	0,70	ungefärbt / undyed	PRN30221	24
HR 22 ● 	4-0	1.5	0,70	ungefärbt / undyed	PRN30208	24
	3-0	2	0,70	ungefärbt / undyed	PRN30209	24
	2-0	3	0,70	ungefärbt / undyed	PRN30210	24
HR 27 ● 	4-0	1.5	0,70	ungefärbt / undyed	PRN30213	24
	3-0	2	0,70	ungefärbt / undyed	PRN30214	24
	2-0	3	0,70	ungefärbt / undyed	PRN30215	24
	0	3.5	0,70	ungefärbt / undyed	PRN30216	24
HRS 27 ● 	2-0	3	0,70	ungefärbt / undyed	PRN30303	24
	0	3.5	0,70	ungefärbt / undyed	PRN30304	24
HR 35 ● 	0	3.5	0,90	ungefärbt / undyed	PRN30217	24
HRS 35 ● 	2-0	3	0,90	ungefärbt / undyed	PRN30308	24
	0	3.5	0,90	ungefärbt / undyed	PRN30309	24
	1	4	0,90	ungefärbt / undyed	PRN30310	24
HRS 40 ● 	0	3.5	0,90	ungefärbt / undyed	PRN30313	24
	1	4	0,90	ungefärbt / undyed	PRN30314	24
HRS 48 ● 	1	4	0,90	ungefärbt / undyed	PRN30317	24
	2	5	0,90	ungefärbt / undyed	PRN30318	24





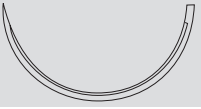







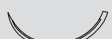

PGA resoquick™

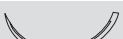
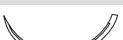
Sterile Nadel-Faden-Kombination / *needle suture combination, sterile*

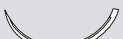
Nadel / needle	Stärke / gauge USP	gauge metric	Länge / length (m)	Farbe / colour	Best.-Nr. / code no.	Packungsinhalt / box content (Stück / pieces)
HR 50 ● 	0	3.5	1,20	ungefärbt / undyed	PRN30219	24
	0	3.5	1,50	ungefärbt / undyed	PRN30218	24
HRT = 1/2-Kreis schneidende Rundkörper (Diamond-Spitze) / <i>HRT = 1/2 circle, taper cutting</i>						
HRT 25 ◐ 	3-0	2	0,70	ungefärbt / undyed	PRN30614	24
HRT 35 ◐ 	2-0	3	0,70	ungefärbt / undyed	PRN30612	24
	2-0	3	0,90	ungefärbt / undyed	PRN30608	24
	0	3.5	0,90	ungefärbt / undyed	PRN30609	24
	1	4	0,70	ungefärbt / undyed	PRN30613	24
HRT 45 ◐ 	2-0	3	0,90	ungefärbt / undyed	PRN30611	24
DRT = 3/8-Kreis schneidende Rundkörper (Diamond-Spitze) / <i>DRT = 3/8 circle, taper cutting</i>						
DRT 18 ◑ 	4-0	1.5	0,70	ungefärbt / undyed	PRN30801	24
HS = 1/2-Kreis außen schneidend <i>HS = 1/2 circle, reverse cutting</i>						
HS 18 ▼ 	4-0	1.5	0,45	ungefärbt / undyed	PRN31103	24
	3-0	2	0,45	ungefärbt / undyed	PRN31104	24
HS 20 ▼ 	3-0	2	0,70	ungefärbt / undyed	PRN31117	24
	3-0	2	0,90	ungefärbt / undyed	PRN31115	24
HS 22 ▼ 	3-0	2	0,45	ungefärbt / undyed	PRN31107	24
	3-0	2	0,70	ungefärbt / undyed	PRN31116	24
	2-0	3	0,45	ungefärbt / undyed	PRN31108	24
HS 35 ▼ 	2-0	3	0,90	ungefärbt / undyed	PRN31118	24
HS 40 ▼ 	1	4	0,90	ungefärbt / undyed	PRN31114	24

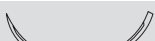

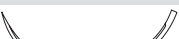
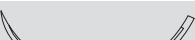
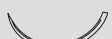
PGA resoquick™

Sterile Nadel-Faden-Kombination / *needle suture combination, sterile*

Nadel / needle	Stärke / gauge		Länge / length (m)	Farbe / colour	Best.-Nr. / code no.	Packungsinhalt / box content (Stück / pieces)
	USP	metric				
DS = 3/8-Kreis außen schneidend DSM = mit PREMIUM-Schliff <i>DS = 3/8 circle, reverse cutting, DSM = PREMIUM cut</i>						
DSM 11   PREMIUM-Schliff / <i>PREMIUM cut</i>	6-0	0,7	0,45	ungefärbt / <i>undyed</i>	PRN31502	24
	6-0	0,7	0,75	ungefärbt / <i>undyed</i>	PRN31527	24
DSM 13   PREMIUM-Schliff / <i>PREMIUM cut</i>	6-0	0,7	0,45	ungefärbt / <i>undyed</i>	PRN31528	24
	5-0	1	0,45	ungefärbt / <i>undyed</i>	PRN31504	24
	4-0	1,5	0,45	ungefärbt / <i>undyed</i>	PRN31505	24
DS 16 	5-0	1	0,75	ungefärbt / <i>undyed</i>	PRN31428	24
	4-0	1,5	0,70	ungefärbt / <i>undyed</i>	PRN31427	24
DS 18 	5-0	1	0,45	ungefärbt / <i>undyed</i>	PRN31405	24
	4-0	1,5	0,45	ungefärbt / <i>undyed</i>	PRN31426	24
	4-0	1,5	0,75	ungefärbt / <i>undyed</i>	PRN31429	24
	3-0	2	0,45	ungefärbt / <i>undyed</i>	PRN31408	24
	2-0	3	0,75	ungefärbt / <i>undyed</i>	PRN31431	24
	4-0	1,5	0,45	ungefärbt / <i>undyed</i>	PRN31410	24
DS 18 F 	2-0	3	0,75	ungefärbt / <i>undyed</i>	PRN31431	24
	4-0	1,5	0,45	ungefärbt / <i>undyed</i>	PRN31516	24
DSM 18 F   PREMIUM-Schliff / <i>PREMIUM cut</i>	4-0	1,5	0,70	ungefärbt / <i>undyed</i>	PRN31517	24
	4-0	1,5	0,45	ungefärbt / <i>undyed</i>	PRN31510	24
DSM 18   PREMIUM-Schliff / <i>PREMIUM cut</i>	4-0	1,5	0,70	ungefärbt / <i>undyed</i>	PRN31509	24
	3-0	2	0,70	ungefärbt / <i>undyed</i>	PRN31511	24
	3-0	2	0,45	ungefärbt / <i>undyed</i>	PRN31420	24
DS 24 	2-0	3	0,45	ungefärbt / <i>undyed</i>	PRN31422	24
	3-0	2	0,70	ungefärbt / <i>undyed</i>	PRN31421	24
	2-0	3	0,70	ungefärbt / <i>undyed</i>	PRN31423	24
	3-0	2	0,45	ungefärbt / <i>undyed</i>	PRN31520	24
DSM 24   PREMIUM-Schliff / <i>PREMIUM cut</i>	2-0	3	0,45	ungefärbt / <i>undyed</i>	PRN31522	24
	3-0	2	0,70	ungefärbt / <i>undyed</i>	PRN31521	24
	2-0	3	0,70	ungefärbt / <i>undyed</i>	PRN31523	24
	3-0	2	0,70	ungefärbt / <i>undyed</i>	PRN31424	24
DS 27 	3-0	2	0,70	ungefärbt / <i>undyed</i>	PRN31424	24
DS 30 	2-0	3	0,90	ungefärbt / <i>undyed</i>	PRN31430	24
DSMI = 3/8-Kreis innen schneidend, mit PREMIUM-Schliff <i>DSMI = 3/8 circle, conventional cutting, PREMIUM cut</i>						
DSMI 16   PREMIUM-Schliff / <i>PREMIUM cut</i>	4-0	1,5	0,75	ungefärbt / <i>undyed</i>	PRN32901	24

PGA resoquick™

Sterile Nadel-Faden-Kombination / *needle suture combination, sterile*

Nadel / needle	Stärke / gauge		Länge / length (m)	Farbe / colour	Best.-Nr. / code no.	Packungsinhalt / box content (Stück / pieces)
	USP	metric				
GS = Gerade schneidend <i>GS = straight, cutting</i>						
GS 12 ▼ 	4-0	1.5	0,45	ungefärbt / undyed	PRN31703	24
DSPM = 3/8-Kreis SPATULA, mit PREMIUM-Schliff <i>DSPM = 3/8 circle, spatulated, PREMIUM cut</i>						
2x DSPM 7  PREMIUM-Schliff / PREMIUM cut	8-0	0.4	0,45	ungefärbt / undyed	PRN3201	24
	7-0	0.5	0,45	ungefärbt / undyed	PRN3202	24

PGA resoquick™

Einzelfadenpackungen, steril in vorgeschrittenen Längen / *Sterile pre-cut suture, non-needed*

Stärke / gauge	Länge / length		Farbe / colour	Best.-Nr. / code no.	Packungsinhalt / box content (Stück / pieces)
	USP	metric			
3-0	2	3 x 0,45	ungefärbt / undyed	PWN433	24
2-0	3	3 x 0,45	ungefärbt / undyed	PWN533	24
3-0	2	6 x 0,45	ungefärbt / undyed	PWN465	24
2-0	3	6 x 0,45	ungefärbt / undyed	PWN565	24
0	3.5	6 x 0,45	ungefärbt / undyed	PWN665	24
2-0	3	2 x 0,70	ungefärbt / undyed	PWN520	24
0	3.5	2 x 0,70	ungefärbt / undyed	PWN620	24
1	4	2 x 0,70	ungefärbt / undyed	PWN720	24
2-0	3	3 x 0,70	ungefärbt / undyed	PWN733	24





- kurzfristig resorbierbares Monofilament
- hohe Reißkraft
- glatter Gewebedurchzug
- minimale Gewebereaktion
- guter Knotensitz

- *short term absorbable monofilament*
- *high tensile strength*
- *smooth tissue passage*
- *minimized tissue trauma*
- *perfect knot security*

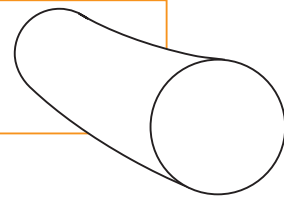

Eigenschaften:

- hohe Reißkraft
- guter Knotensitz
- atraumatischer Gewebedurchzug

Zur Herstellung von GLYCOLON® werden die beiden Materialbestandteile Polyglykolsäure und ϵ -Caprolacton in einem bestimmten Verhältnis copolymerisiert.

Der Abbau des polymeren Fadensmaterials im Gewebe erfolgt durch Wasseraufnahme in Umkehrung der

Synthese. Nach Implantation nimmt die Reißkraft von GLYCOLON® nach 7 Tagen auf 30% ab.

Gewebereaktionen werden zum einen durch die dabei entstehenden unbedenklichen Zwischenprodukte, zum anderen durch die monofile und glatte Oberflächenstruktur des Fadens minimiert.

GLYCOLON® besitzt durch die glatten und monofilen Oberflächenstrukturen des Polymers ausgezeichnete Eigenschaften bezüglich des Handlings und der Gleitfähigkeit.

Gewebetraumatisierungen durch den Fadedurchzug sind bei GLYCOLON® nicht relevant und die monofile Struktur verhindert eine

Dochtwirkung des Fadens ohne zusätzliche Oberflächenbehandlung.

GLYCOLON® ist ungefärbt, besonders für Hautnähte, und violett (mit dem physiologisch unbedenklichen Farbstoff D+C Nr.2) eingefärbt erhältlich.

- ➔ Farbe: ungefärbt oder violett
- ➔ Chemische Bezeichnung: [Poly(Glykolsäure-co- ϵ -Caprolacton)]
- ➔ Fadenstärke: USP 6-0 -1 (0.7-4 metric)
- ➔ Konfektionsangebote:
 - Nadel-Faden-Kombinationen
 - in vorgeschrittenen Längen
- ➔ Sterilisation: Ethylenoxid

Properties:

- high tear resistance
- excellent knot security
- atraumatic tissue passage

The production of GLYCOLON® involves the copolymerisation of polyglycolic acid and ϵ -caprolactone in a certain ratio.

The breakdown of the polymeric suture in the tissue occurs through water uptake, thereby reversing the synthesis.

The tear resistance of GLYCOLON® reduces by 30% 7 days after implantation.

The completely safe intermediary products that are formed, as well as the smooth, monofilament surface structure of the thread, result in minimal tissue reaction.

The smooth, monofilament surface structures of the polymer give GLYCOLON® excellent handling and tissue passage properties.











Tissue trauma as a result of suturing is not relevant to GLYCOLON®, and the monofilament structure prevents wicking of the thread without the need for additional surface treatment.

GLYCOLON® is available undyed, especially suitable for skin closure, and in violet (coloured with the physiologically harmless D+C No. 2 dye).

- ➔ Colour: undyed or violet
- ➔ Chemical name: [poly(glycolic acid-co- ϵ -caprolactone)]
- ➔ Thread diameter: USP 6-0 -1 (0.7-4 metric)
- ➔ Types of packaging:
 - needle-thread-combinations
 - precut lengths
- ➔ Sterilization method: ethylene oxide











GLYCOLON®

Sterile Nadel-Faden-Kombination / *needle suture combination, sterile*

Nadel / needle	Stärke / gauge		Länge / length (m)	Farbe / colour	Best.-Nr. / code no.	Packungsinhalt / box content (Stück / pieces)
	USP	metric				
FR = 5/8-Kreis Rundkörper <i>FR = 5/8 circle, taper point</i>						
FR 27 ● 	3-0	2	0,70	violett / violet	PB4012	24
2 x FR 27 ● 	3-0	2	0,70	violett / violet	PB4011	24
2 x FR 35 ● 	2-0	3	0,70	violett / violet	PB4010	24
HR, HRS = 1/2-Kreis Rundkörper <i>HR, HRS = 1/2 circle, taper point</i>						
HR 12 ● 	6-0	0.7	0,45	violett / violet	PB40204	24
	5-0	1	0,45	violett / violet	PB40200	24
HR 17 ● 	5-0	1	0,70	violett / violet	PB40201	24
	4-0	1.5	0,70	violett / violet	PB40202	24
	3-0	2	0,70	violett / violet	PB40203	24
2 x HR 17 ● 	5-0	1	0,70	violett / violet	PB40207	24
HR 22 ● 	4-0	1.5	0,70	violett / violet	PB40215	24
	3-0	2	0,70	violett / violet	PB40216	24
	2-0	3	0,70	violett / violet	PB40217	24
2 x HR 22 ● 	4-0	1.5	0,90	violett / violet	PB40227S	24
HR 27 ● 	4-0	1.5	0,70	violett / violet	PB40230	24
	3-0	2	0,70	violett / violet	PB40231	24
	2-0	3	0,70	violett / violet	PB40232	24
2x HRS 27 ● 	4-0	1.5	0,90	violett / violet	PB40236	24
2x HR 27 ● 	3-0	2	0,90	violett / violet	PB40239S	24

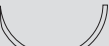
GLYCOLON®





Sterile Nadel-Faden-Kombination / *needle suture combination, sterile*

Nadel / needle		Stärke / gauge		Länge / length (m)	Farbe / colour	Best.-Nr. / code no.	Packungsinhalt / box content (Stück / pieces)
		USP	metric				
HRS 27 ●		0	3.5	0,70	violett / violet	PB40310	24
		1	4	0,90	violett / violet	PB40313	24
HR 35 ●		2-0	3	0,70	violett / violet	PB40241	24
		0	3.5	0,70	violett / violet	PB40242	24
HRS 35 ●		0	3.5	0,90	violett / violet	PB40324	24
		1	4	0,90	violett / violet	PB40325	24
HRS 40 ●		0	3.5	0,90	violett / violet	PB40334	24
		1	4	0,90	violett / violet	PB40335	24
HRS 48 ●		1	4	0,90	violett / violet	PB40343	24
HRT = 1/2-Kreis schneidende Rundkörper (Diamond-Spitze) <i>HRT = 1/2 circle, taper cutting</i>							
HRT 16 ▼		5-0	1	0,45	violett / violet	PB40602	24
HRT 18 ▼		4-0	1.5	0,70	violett / violet	PB40605	24
		3-0	2	0,70	violett / violet	PB40606	24
HRT 22 ▼		4-0	1.5	0,70	violett / violet	PB40613	24
HRT 25 ▼		2-0	3	0,70	violett / violet	PB40620	24
		2-0	3	0,70	ungefärbt / undyed	PB40621*	24
HS = 1/2-Kreis außen schneidend HSM = mit PREMIUM-Schliff <i>HS = 1/2 circle, reverse cutting</i> <i>HSM = PREMIUM cut</i>							
HSM 9 ▽ PREMIUM-Schliff / PREMIUM cut		6-0	0.7	0,45	violett / violet	PB41201	24
HS 18 ▼		4-0	1.5	0,70	violett / violet	PB41101	24

*eventuell mit verlängerter Lieferzeit verbunden / *possibly associated with an extended delivery time*



GLYCOLON®

Sterile Nadel-Faden-Kombination / *needle suture combination, sterile*

Nadel / needle	Stärke / gauge		Länge / length (m)	Farbe / colour	Best.-Nr. / code no.	Packungsinhalt / box content (Stück / pieces)	
	USP	metric					
DS = 3/8-Kreis außen schneidend DSM = mit PREMIUM-Schliff <i>DS = 3/8 circle, reverse cutting</i> <i>DSM = PREMIUM cut</i>							
DSM 11  ▼ PREMIUM-Schliff / PREMIUM cut	6-0	0,7	0,45	violett / violet	PB41512	24	
	5-0	1	0,45	violett / violet	PB41501	24	
	6-0	0,7	0,45	ungefärbt / undyed	PB41502	24	
DSM 13  ▼ PREMIUM-Schliff / PREMIUM cut	6-0	0,1	0,45	violett / violet	PB41527	24	
	5-0	1	0,45	violett / violet	PB41503	24	
	4-0	1,5	0,45	violett / violet	PB41508	24	
	5-0	1	0,70	violett / violet	PB41507	24	
	6-0	0,7	0,45	ungefärbt / undyed	PB41504	24	
	5-0	1	0,45	ungefärbt / undyed	PB41505	24	
	4-0	1,5	0,45	ungefärbt / undyed	PB41506	24	
	5-0	1	0,70	ungefärbt / undyed	PB41523	24	
	DSM 16  ▼ PREMIUM-Schliff / PREMIUM cut	5-0	1	0,45	violett / violet	PB41509	24
4-0		1,5	0,45	violett / violet	PB41511	24	
5-0		1	0,70	violett / violet	PB41528	24	
5-0		1	0,45	ungefärbt / undyed	PB41524	24	
4-0		1,5	0,45	ungefärbt / undyed	PB41510	24	
4-0		1,5	0,70	ungefärbt / undyed	PB41525	24	
DS 18  ▼	5-0	1	0,45	violett / violet	PB41421	24	
	4-0	1,5	0,45	violett / violet	PB41420	24	
	3-0	2	0,45	violett / violet	PB41413	24	
	4-0	1,5	0,70	violett / violet	PB41416	24	
	4-0	1,5	0,45	ungefärbt / undyed	PB41411	24	
	3-0	2	0,45	ungefärbt / undyed	PB41412	24	
	5-0	1	0,70	ungefärbt / undyed	PB41410	24	
	4-0	1,5	0,70	ungefärbt / undyed	PB41414	24	
	3-0	2	0,70	ungefärbt / undyed	PB41415	24	
	5-0	1	0,70	violett / violet	PB41422	24	
	DSM 18  ▼ PREMIUM-Schliff / PREMIUM cut	4-0	1,5	0,70	violett / violet	PB41515	24
		3-0	2	0,90	violett / violet	PB41529	24
5-0		1	0,45	ungefärbt / undyed	PB41516	24	
4-0		1,5	0,45	ungefärbt / undyed	PB41513	24	
3-0		2	0,45	ungefärbt / undyed	PB41514	24	
4-0		1,5	0,70	ungefärbt / undyed	PB41522	24	
3-0		2	0,70	ungefärbt / undyed	PB41526	24	

GLYCOLON®

Sterile Nadel-Faden-Kombination / *needle suture combination, sterile*

Nadel / needle		Stärke / gauge		Länge / length (m)	Farbe / colour	Best.-Nr. / code no.	Packungsinhalt / box content (Stück / pieces)
		USP	metric				
DS 21 ▼		4-0	1.5	0,70	violett / violet	PB41417	24
DS 24 ▼		3-0	2	0,70	ungefärbt / undyed	PB41418	24
		2-0	3	0,70	ungefärbt / undyed	PB41419	24
DSM 24 ▽ PREMIUM-Schliff / PREMIUM cut		3-0	2	0,70	ungefärbt / undyed	PB41520	24
		2-0	3	0,70	ungefärbt / undyed	PB41521	24

GLYCOLON®

Einzelfadenpackungen, steril in vorgeschrittenen Längen
Sterile pre-cut suture, non-needled

Stärke / gauge	Länge / length (m)	Farbe / colour	Best.-Nr. / code no.	Packungsinhalt / box content (Stück / pieces)
4-0	1.5	3 x 0,45	PT333	24
3-0	2	3 x 0,45	PT433	24
2-0	3	3 x 0,45	PT533	24



- mittelfristig resorbierbares Multifilament
- hohe Reißkraft
- minimales Gewebetrauma
- glatter Gewebedurchzug
- guter Knotensitz

- *midterm absorbable multifilament*
- *high tensile strength*
- *minimized tissue trauma*
- *smooth tissue passage*
- *perfect knot security*

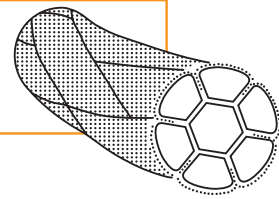

Eigenschaften:

- hohe Reißkraft
- gutes Handling
- guter Knotensitz
- atraumatischer Gewebedurchzug
- minimale Gewebereaktion

PGA RESORBA® ist ein Polymer der Glykolsäure. Die linear hochmolekulare Polyglykolsäure wird unter Einwirkung eines Katalysators über das Zwischenprodukt Glykolid, einem zyklischen Ester, synthetisiert.

Der Abbau des PGA-Fadenmaterials im Gewebe erfolgt durch Wasseraufnahme in Umkehrung der Synthese.

Die monomere Glykolsäure wird durch den normalen Stoffwechsel enzymatisch in CO_2 und H_2O gespalten. Fadenmaterial mit einem Anteil von 10% Lactid als Copolymer unterscheidet sich in seinem physikalischen und physiologischen Verhalten nur geringfügig von reinen PGA-Fäden.

Die feinen, präzisionsgeflochtenen Filamente gewähren eine sehr hohe Reißfestigkeit sowie eine ausgezeichnete Geschmeidigkeit.

Die spezielle Beschichtung legt sich fein um die Faserbündel und führt zu einer gezielten Herabsetzung der Oberflächenreibung. Resorbierbare Nahtmaterialien adaptieren das Gewebe während der Heilungsphase und verlieren dabei zunehmend ihre Zugfestigkeit und Reißkraft.

Bei PGA RESORBA® führen die präzisionsgeflochtenen Filamente aus Polyglykolsäure zu einem standardisierten, mittelfristigen Resorptionsverhalten im Gewebe. 18 Tage nach Implantation liegt die Reißkraft von PGA RESORBA® bei 50% der ursprünglichen Reißkraft.*

Violettes PGA RESORBA® ist mit einem physiologisch unbedenklichen Farbstoff gefärbt.

- ➔ Farbe: violett oder ungefärbt
- ➔ Chemische Bezeichnung: Polyglykolsäure
- ➔ Fadenstärke: USP 8-0 -5 (0.4-7 metric)
- ➔ Konfektionsangebote:
 - Nadel-Faden-Kombinationen
 - in vorgeschrittenen Längen
- ➔ Sterilisation: Ethylenoxid

* Bei Artikeln, die von Healthium hergestellt werden, liegt die ursprüngliche Reißkraft 21 Tage nach Implantation bei 55%

Properties:

- high tear resistance
- good handling
- excellent knot security
- atraumatic tissue passage
- minimal tissue reaction

PGA RESORBA® is a polymer of glycolic acid. The linear, high molecular weight polyglycolic acid is synthesised in the presence of a catalyst via the intermediary product glycolide, a cyclic ester.

The breakdown of the PGA suture in the tissue occurs through water

uptake, thereby reversing the synthesis. Regular metabolic processes break down the glycolic acid monomers into CO_2 and H_2O through enzymatic degradation. The physical and physiological properties of suture material containing 10% lactide as copolymer differ only slightly from pure PGA sutures.

The thin, precision-braided filaments provide very high tear resistance as well as excellent suppleness.

The special coating thinly encapsulates the fibre bundles resulting in a specific reduction of surface friction. Absorbable sutures approximate the tissue during the healing phase; at the same time, they increasingly lose their tensile strength and tear resistance.

PGA RESORBA® contains precision-braided filaments made of polyglycolic acid that result in a standardised, moderate rate of absorption in the tissue. Depending on the thread diameter 50% of the original tensile strength of PGA RESORBA® is lost after 18 days.*









Violet PGA RESORBA® is coloured with a physiologically harmless dye.

- ➔ Colour: violet or undyed
- ➔ Chemical name: polyglycolic acid
- ➔ Thread diameter: USP 8-0 -5 (0.4-7 metric)
- ➔ Types of packaging:
 - needle-thread-combinations
 - precut lengths
- ➔ Sterilization method: ethylene oxide

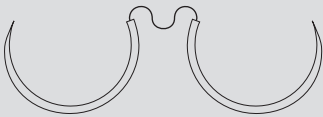
* Articles manufactured by Healthium are experience loss of strength down to 55% after 21 days





PGA RESORBA®

Sterile Nadel-Faden-Kombination / *needle suture combination, sterile*

Nadel / needle	Stärke / gauge		Länge / length (m)	Farbe / colour	Best.-Nr. / code no.	Packungsinhalt / box content (Stück / pieces)
	USP	metric				
FR = 5/8-Kreis Rundkörper <i>FR = 5/8 circle, taper point</i>						
FR 27 ● 	3-0	2	0,70	violett / violet	PA1011	24
	2-0	3	0,70	violett / violet	PA1019	24
	0	3.5	0,70	violett / violet	PA1015	24
FR 35 ● 	0	3.5	0,70	violett / violet	PA1013	24
	1	4	0,70	violett / violet	PA1014	24
2 x FR 35 ● 	2-0	3	0,70	violett / violet	PA1012	24
	0	3.5	0,90	violett / violet	PA1018	24
FR 40 ● 	0	3.5	0,70	violett / violet	PA1016	24
HR, HRS, HRX = 1/2-Kreis Rundkörper <i>HR, HRS, HRX = 1/2 circle, taper point</i>						
HR 8 ● 	7-0	0.5	0,45	violett / violet	PA10289	12
HR 10 ● 	5-0	1	0,70	ungefärbt / undyed	PA10262	24
HR 12 ● 	6-0	0.7	0,45	violett / violet	PA10273	24
	5-0	1	0,45	violett / violet	PA10274	24
	6-0	0.7	0,70	violett / violet	PA1021	24
	5-0	1	0,70	violett / violet	PA1022	24
	4-0	1.5	0,70	violett / violet	PA1023	24
	6-0	0.7	0,70	ungefärbt / undyed	PA10242	24
	5-0	1	0,70	ungefärbt / undyed	PA10265	24
	4-0	1.5	0,70	ungefärbt / undyed	PA10266	24
HRS 12 ● 	3-0	2	0,70	violett / violet	PA10328	24
	2-0	3	0,70	violett / violet	PA10329	24
	0	3.5	0,70	violett / violet	PA10330	2
HR 17 ● 	5-0	1	0,70	violett / violet	PA1024	24
	4-0	1.5	0,70	violett / violet	PA1025	24
	3-0	2	0,70	violett / violet	PA1026	24
	2-0	3	0,70	violett / violet	PA1027	24
	5-0	1	0,70	ungefärbt / undyed	PA10248	24
	4-0	1.5	0,70	ungefärbt / undyed	PA10243	24
	3-0	2	0,70	ungefärbt / undyed	PA10244	24
	2-0	3	0,70	ungefärbt / undyed	PA10258	24



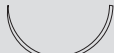

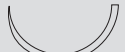
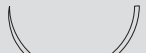

PGA RESORBA®

Sterile Nadel-Faden-Kombination / *needle suture combination, sterile*

Nadel / needle	Stärke / gauge USP	metric	Länge / length (m)	Farbe / colour	Best.-Nr. / code no.	Packungsinhalt / box content (Stück / pieces)			
HRS 17 ●		2-0	3	0,70	violett / violet	PA10378	24		
		0	3.5	0,70	violett / violet	PA10379	24		
		1	4	0,70	violett / violet	PA10380	24		
HR 17 A ● Abziehnadel / control release needle		5-0	1	4 x 0,45	violett / violet	PA10256 (M)	12		
		4-0	1.5	4 x 0,45	violett / violet	PA10287 (M)	12		
		3-0	2	4 x 0,45	violett / violet	PA10288 (M)	12		
		4-0	1.5	8 x 0,45	violett / violet	PA1028 (M)	12		
		3-0	2	8 x 0,45	violett / violet	PA1029 (M)	12		
		4-0	1.5	4 x 0,70	violett / violet	PA10284 (M)	12		
HR 22 ●		4-0	1.5	0,70	violett / violet	PA10210	24		
		3-0	2	0,70	violett / violet	PA10211	24		
		2-0	3	0,70	violett / violet	PA10212	24		
		3-0	2	4 x 0,70	violett / violet	PA10283 (M)	12		
		3-0	2	0,70	ungefärbt / undyed	PA10254	24		
		2-0	3	0,70	ungefärbt / undyed	PA10255	24		
		HR 22 A ● Abziehnadel / control release needle		4-0	1.5	4 x 0,45	violett / violet	PA10252 (M)	12
3-0	2			4 x 0,45	violett / violet	PA10286 (M)	12		
2-0	3			4 x 0,45	violett / violet	PA10276 (M)	12		
4-0	1.5			8 x 0,45	violett / violet	PA10213 (M)	12		
3-0	2			8 x 0,45	violett / violet	PA10214 (M)	12		
2-0	3			8 x 0,45	violett / violet	PA10215 (M)	12		
3-0	2			4 x 0,70	violett / violet	PA10241 (M)	12		
4-0	1.5			8 x 0,70	violett / violet	PA10285 (M)	12		
HRS 22 ●				2-0	3	0,70	violett / violet	PA10331	24
				0	3.5	0,70	violett / violet	PA10332	24
		1	4	0,70	violett / violet	PA10333	24		
		0	3.5	4 x 0,70	violett / violet	PA10357 (M)	12		
HR 27 ●		4-0	1.5	0,70	violett / violet	PA10216	24		
		3-0	2	0,70	violett / violet	PA10217	24		
		2-0	3	0,70	violett / violet	PA10218	24		
		0	3.5	0,70	violett / violet	PA10219	24		
		4-0	1.5	0,90	violett / violet	PA10220	24		
		3-0	2	0,90	violett / violet	PA10221	24		
		2-0	3	0,90	violett / violet	PA10222	24		
		0	3.5	0,90	violett / violet	PA10223	24		
		3-0	2	0,70	ungefärbt / undyed	PA10250	24		
		2-0	3	0,70	ungefärbt / undyed	PA10251	24		
		0	3.5	0,70	ungefärbt / undyed	PA10253	24		
		2-0	3	6 x 0,70	violett / violet	PA10249 (M)	12		







PGA RESORBA®

Sterile Nadel-Faden-Kombination / *needle suture combination, sterile*

Nadel / needle	Stärke / gauge		Länge / length (m)	Farbe / colour	Best.-Nr. / code no.	Packungsinhalt / box content (Stück / pieces)	
	USP	metric					
HR 27 A ● Abziehnadel / control release needle 	4-0	1.5	4 x 0,45	violett / violet	PA10227 (M)	12	
	3-0	2	4 x 0,45	violett / violet	PA10228 (M)	12	
	2-0	3	4 x 0,45	violett / violet	PA10229 (M)	12	
	4-0	1.5	8 x 0,45	violett / violet	PA10224 (M)	12	
	3-0	2	8 x 0,45	violett / violet	PA10225 (M)	12	
	2-0	3	8 x 0,45	violett / violet	PA10226 (M)	12	
	3-0	2	0,70	violett / violet	PA10280	24	
	4-0	1.5	4 x 0,70	violett / violet	PA10230 (M)	12	
	3-0	2	4 x 0,70	violett / violet	PA10231 (M)	12	
	2-0	3	4 x 0,70	violett / violet	PA10232 (M)	12	
	0	3.5	4 x 0,70	violett / violet	PA10261 (M)	12	
	3-0	2	4 x 0,45	ungefärbt / undyed	PA10263 (M)	12	
	2-0	3	4 x 0,45	ungefärbt / undyed	PA10264 (M)	12	
	HRS 27 ● 	2-0	3	0,70	violett / violet	PA1030	24
0		3.5	0,70	violett / violet	PA1031	24	
1		4	0,70	violett / violet	PA1032	24	
2		5	0,70	violett / violet	PA10334	24	
2-0		3	0,90	violett / violet	PA10335	24	
0		3.5	0,90	violett / violet	PA1033	24	
1		4	0,90	violett / violet	PA1034	24	
2		5	0,90	violett / violet	PA1035	24	
1		4	4 x 0,70	violett / violet	PA10364 (M)	12	
2		5	4 x 0,70	violett / violet	PA10351 (M)	12	
2-0		3	0,70	ungefärbt / undyed	PA10353	24	
HRS 27 A ● Abziehnadel / control release needle 		2-0	3	4 x 0,45	violett / violet	PA10336 (M)	12
		0	3.5	4 x 0,45	violett / violet	PA10337 (M)	12
		1	4	4 x 0,45	violett / violet	PA10338 (M)	12
	0	3.5	8 x 0,45	violett / violet	PA10348 (M)	12	
	1	4	8 x 0,45	violett / violet	PA10372 (M)	12	
	0	3.5	4 x 0,70	violett / violet	PA10339 (M)	12	
	1	4	4 x 0,70	violett / violet	PA10340 (M)	12	
	2	5	4 x 0,70	violett / violet	PA10341 (M)	12	
	HRX 27 ● 	1	4	0,90	violett/violet	PA1041	24
HRX 27 A ● Abziehnadel / control release needle 	1	4	4 x 0,70	violett / violet	PA1045 (M)	12	
HR 30 ● 	3-0	2	0,70	violett / violet	PA10245	24	
	2-0	3	0,70	violett / violet	PA10233	24	
	0	3.5	0,70	violett / violet	PA10234	24	

PGA RESORBA®







Sterile Nadel-Faden-Kombination / *needle suture combination, sterile*

Nadel / needle	Stärke / gauge		Länge / length (m)	Farbe / colour	Best.-Nr. / code no.	Packungsinhalt / box content (Stück / pieces)
	USP	metric				
HR 30 A ● Abziehnadel / <i>control release needle</i> 	0	3.5	4 x 0,70	violett / violet	PA10270 (M)	12
HRX 30 ● 	1	4	0,90	violett / violet	PA1042	24
	2	5	0,90	violett / violet	PA1043	24
HR 35 ● 	3-0	2	0,70	violett / violet	PA10246	24
	2-0	3	0,70	violett / violet	PA10235	24
	0	3.5	0,70	violett / violet	PA10236	24
	1	4	0,70	violett / violet	PA10237	24
	3-0	2	0,90	violett / violet	PA10247	24
	2-0	3	0,90	violett / violet	PA10238	24
	0	3.5	0,90	violett / violet	PA10239	24
	1	4	0,90	violett / violet	PA10240	24
	3-0	2	0,70	ungefärbt / undyed	PA10272	24
HR 35 A ● Abziehnadel / <i>control release needle</i> 	3-0	2	4 x 0,45	violett/violet	PA10277 (M)	12
	2-0	3	8 x 0,70	violett/violet	PA10269 (M)	12
	0	3.5	4 x 0,70	violett/violet	PA10267 (M)	12
HRS 35 ● 	2-0	3	0,70	violett / violet	PA1037	24
	0	3.5	0,70	violett / violet	PA1038	24
	1	4	0,70	violett / violet	PA1039	24
	3-0	2	0,90	violett / violet	PA10371	24
	2-0	3	0,90	violett / violet	PA10310	24
	0	3.5	0,90	violett / violet	PA10311	24
	1	4	0,90	violett / violet	PA10312	24
	2	5	0,90	violett / violet	PA10313	24
	2-0	3	0,90	ungefärbt / undyed	PA10349	24
HRS 35 A ● Abziehnadel / <i>control release needle</i> 	0	3.5	4 x 0,45	violett / violet	PA10314 (M)	12
	1	4	4 x 0,45	violett / violet	PA10315 (M)	12
	2	5	4 x 0,45	violett / violet	PA10316 (M)	12
	0	3.5	8 x 0,50	violett / violet	PA10324 (M)	12
	1	4	4 x 0,70	violett / violet	PA10343 (M)	12
	2	5	4 x 0,70	violett / violet	PA10344 (M)	12
	0	3.5	4 x 0,45	ungefärbt / undyed	PA10360 (M)	12
	1	4	4 x 0,45	ungefärbt / undyed	PA10361 (M)	12
	HRX 35 ● 	0	3.5	0,70	violett / violet	PA1047
1		4	0,70	violett / violet	PA1046	24
1		4	0,90	violett / violet	PA1044	24

(M) = Multipack

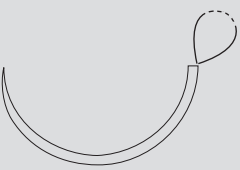
PGA RESORBA®

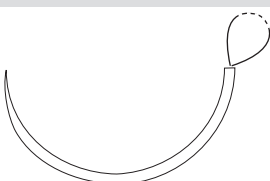



Sterile Nadel-Faden-Kombination / *needle suture combination, sterile*

Nadel / needle	Stärke / gauge USP	metric	Länge / length (m)	Farbe / colour	Best.-Nr. / code no.	Packungsinhalt / box content (Stück / pieces)
HR 40 ● 	3-0	2	0,90	violett / violet	PA10290	24
	2-0	3	0,90	violett / violet	PA10282	24
HRS 40 ● 	2-0	3	0,70	violett / violet	PA10370	24
	0	3.5	0,70	violett / violet	PA10317	24
	1	4	0,70	violett / violet	PA10318	24
	0	3.5	0,90	violett / violet	PA10319	24
	1	4	0,90	violett / violet	PA10320	24
	2	5	0,90	violett / violet	PA10321	24
	0	3.5	0,70	ungefärbt / undyed	PA10355	24
	0	3.5	0,90	ungefärbt / undyed	PA10362	24
	1	4	0,90	ungefärbt / undyed	PA10363	24
	HRS 40 ● Schlinge / loop 	1	4	1,50	violett / violet	PAN10322 ¹⁾
HRS 40 A ●  Abziehnadel / control release needle	1	1	4 x 0,45	violett / violet	PA10323 (M)	12
	2	5	4 x 0,45	violett / violet	PA10345 (M)	12
	2-0	3	8 x 0,45	violett / violet	PA10365 (M)	12
	1	4	8 x 0,45	violett / violet	PA10373 (M)	12
	2	5	4 x 0,70	violett / violet	PA10375 (M)	12
HRS 48 ● 	3-0	2	0,70	violett / violet	PA10359	24
	2-0	3	0,70	violett / violet	PA10368	24
	0	3.5	0,70	violett / violet	PA10377	24
	0	3.5	0,90	violett / violet	PA10325	24
	1	4	0,90	violett / violet	PA10326	24
	2	5	0,90	violett / violet	PA10327	24
	2	5	1,20	violett / violet	PA10354	24
	1	4	0,70	ungefärbt / undyed	PA10356	24
	2	5	0,90	ungefärbt / undyed	PAN10374 ¹⁾	24
	HRS 48 ● Schlinge / loop 	1	4	1,50	violett / violet	PAN10352 ¹⁾
HRS 48 A ●  Abziehnadel / control release needle	1	4	4 x 0,45	violett / violet	PA10346 (M)	12
	2	5	4 x 0,45	violett / violet	PA10347 (M)	12
	2	5	8 x 0,45	violett / violet	PA10369 (M)	12

(M) = Multipack

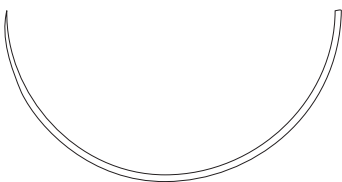
PGA RESORBA®

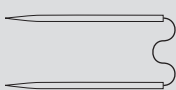







Sterile Nadel-Faden-Kombination / *needle suture combination, sterile*

Nadel / needle	Stärke / gauge		Länge / length (m)	Farbe / colour	Best.-Nr. / code no.	Packungsinhalt / box content (Stück / pieces)
	USP	metric				
HR 50 	2-0	3	0,70	violett / violet	PA10281	24
	1	4	0,70	violett / violet	PA10278	24
	0	3.5	0,90	violett / violet	PA10279	24
	4	6	0,90	violett / violet	PA10271	12
HR 70 	3-0	2	0,70	violett / violet	PA10275	24
	2-0	3	0,70	violett / violet	PA10257	24
	0	3.5	0,70	violett / violet	PA10259	24
	1	4	0,70	violett / violet	PA10260	24
	1	4	1,20	violett / violet	PA10268	24
HRX 75 	2	5	1,20	violett / violet	PA1048	24
GR = Gerade Rundkörper <i>GR = straight, taper point</i>						
2 x GR 20 	4-0	1.5	0,35	violett / violet	PA1091	24
HRT, HRTX = 1/2-Kreis schneidende Rundkörper (Diamond-Spitze) <i>HRT, HRTX = 1/2 circle, taper cutting</i>						
HRT 18 	4-0	1.5	0,70	violett / violet	PA1060	24
	3-0	2	0,70	violett / violet	PA1061	24
	2-0	3	0,70	violett / violet	PA10615	24
	0	3.5	0,70	violett / violet	PA10616	24
	5-0	1	0,70	ungefärbt / undyed	PA10640	24
	4-0	1.5	0,70	ungefärbt / undyed	PA10621	24
	3-0	2	0,70	ungefärbt / undyed	PA10613	24
	2-0	3	0,70	ungefärbt / undyed	PA1062	24
HRT 18 A 	2-0	3	6 x 0,45	violett / violet	PA10620 (M)	12

(M) = Multipack

PGA RESORBA®

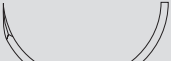

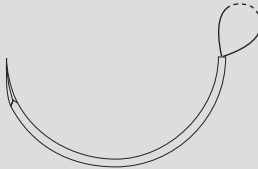



Sterile Nadel-Faden-Kombination / *needle suture combination, sterile*

Nadel / needle	Stärke / gauge USP	metric	Länge / length (m)	Farbe / colour	Best.-Nr. / code no.	Packungsinhalt / box content (Stück / pieces)
HRT 22 	3-0	2	0,70	violett / violet	PA10632	24
	2-0	3	0,70	violett / violet	PA10633	24
	3-0	2	0,70	ungefärbt / undyed	PA10625	24
	2-0	3	0,70	ungefärbt / undyed	PA10629	24
HRT 22 A Abziehnadel / control release needle 	2-0	3	4 x 0,45	violett / violet	PA1068 (M)	12
HRT 25 	3-0	2	0,70	violett / violet	PA1064	24
	2-0	3	0,70	violett / violet	PA1065	24
	0	3,5	0,70	violett / violet	PA1066	24
	3-0	2	0,90	violett / violet	PA10641	24
	2-0	3	0,90	violett / violet	PA10642	24
	1	4	0,90	violett / violet	PA1067	24
	2	5	0,90	violett / violet	PA1063	24
	3-0	2	0,70	ungefärbt / undyed	PA10622	24
	2-0	3	0,70	ungefärbt / undyed	PA10628	24
HRT 25 A Abziehnadel / control release needle 	0	3,5	4 x 0,70	violett / violet	PA10614 (M)	12
	3-0	2	4 x 0,45	ungefärbt / undyed	PA10630 (M)	12
	2-0	3	4 x 0,45	ungefärbt / undyed	PA10631 (M)	12
HRT 30 	2-0	3	0,70	violett / violet	PA10635	12
HRT 35 	1	4	0,70	violett / violet	PA10634	24
	2-0	3	0,90	violett / violet	PA10610	24
	0	3,5	0,90	violett / violet	PA10611	24
	1	4	0,90	violett / violet	PA10612	24
	2	5	0,90	violett / violet	PA10624	24
	2-0	3	0,90	ungefärbt / undyed	PA10623	24
	2-0	3	1,00	ungefärbt / undyed	PA1069	24
HRT 35 A Abziehnadel / control release needle 	1	4	4 x 0,45	violett / violet	PA10619 (M)	12
HRT 40 	1	4	0,70	violett / violet	PA10637	24
	0	3,5	0,70	ungefärbt / undyed	PA10636	24
	1	4	0,70	ungefärbt / undyed	PA10639	24
HRT 45 Schlinge / loop 	1	4	1,50	violett / violet	PAN10627 ¹⁾	24

(M) = Multipack

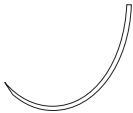
PGA RESORBA®

Sterile Nadel-Faden-Kombination / *needle suture combination, sterile*

Nadel / needle	Stärke / gauge		Länge / length (m)	Farbe / colour	Best.-Nr. / code no.	Packungsinhalt / box content (Stück / pieces)
	USP	metric				
HRTX 50 ▼ 	1	4	0,90	violett / violet	PA10617	24
ART = Asymptotische schneidende Rundkörper <i>ART = asymptotic, taper cutting</i>						
ART 16 ▼ 	4-0	1.5	0,45	ungefärbt / undyed	PA1282	24
ART 25 ▼ 	4-0	1.5	0,45	violett / violet	PA1281	12
	4-0	1.5	0,70	violett / violet	PA1284	24
DR, DRF = 3/8-Kreis Rundkörper <i>DR, DRF = 3/8 circle, taper point</i>						
DR 10 F ● 	6-0	0.7	0,45	violett / violet	PA1071	24
DR 12 A ● Abziehnadel / <i>control release needle</i> 	3-0	2	4 x 0,45	violett / violet	PA1072 (M)	12
DRT = 3/8-Kreis schneidende Rundkörper <i>DRT = 3/8 circle, taper cutting</i>						
DRT 12 ▼ 	6-0	0.7	0,45	violett / violet	PA1081	24
	5-0	1	0,45	violett / violet	PA1082	24
DRT 18 ▼ 	4-0	1.5	0,45	ungefärbt / undyed	PA1083	24
	3-0	2	0,70	ungefärbt / undyed	PA1084	24

(M) = Multipack









PGA RESORBA®

Sterile Nadel-Faden-Kombination / *needle suture combination, sterile*

Nadel / needle	Stärke / gauge		Länge / length (m)	Farbe / colour	Best.-Nr. / code no.	Packungsinhalt / box content (Stück / pieces)
	USP	metric				
HS, HSX = 1/2-Kreis außen schneidend HSM = mit PREMIUM-Schliff <i>HS, HSX = 1/2 circle, reverse cutting</i> <i>HSM = PREMIUM cut</i>						
HSM 13 ▽ PREMIUM-Schliff / PREMIUM cut	5-0	1	0,45	ungefärbt/	PA1120	24
HS 18 ▼	4-0	1.5	0,70	violett / violet	PA11112	24
	3-0	2	0,70	violett / violet	PA11113	24
	2-0	3	0,70	violett / violet	PA11114	24
HS 22 ▼	4-0	1.5	0,70	violett / violet	PA11119	24
	3-0	2	0,70	violett / violet	PA11117	24
	2-0	3	0,70	violett / violet	PA11118	24
	4-0	1.5	0,70	ungefärbt / undyed	PA11118	24
	3-0	2	0,70	ungefärbt / undyed	PA11119	24
	2-0	3	0,70	ungefärbt / undyed	PA11110	24
	2-0	3	0,70	violett / violet	PA11117	24
HSX 22 ▼	2-0	3	0,70	violett / violet	PA11117	24
HS 27 ▼	0	3.5	0,70	violett / violet	PA11111	24
HS 35 ▼	2-0	3	0,70	violett / violet	PA11110	24
	0	3.5	0,70	violett / violet	PA11111	24
	1	4	0,70	violett / violet	PA11112	24
HS 40 ▼	1	4	0,90	violett / violet	PAN11113 ¹⁾	24
	2	5	0,90	violett / violet	PAN11114 ¹⁾	24
HS 50 ▼	1	4	0,70	violett / violet	PA11116	24
	4	6	0,90	violett / violet	PA11115	12



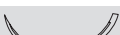

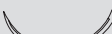
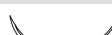



PGA RESORBA®

Sterile Nadel-Faden-Kombination / *needle suture combination, sterile*

Nadel / needle	Stärke / gauge		Länge / length (m)	Farbe / colour	Best.-Nr. / code no.	Packungsinhalt / box content (Stück / pieces)
	USP	metric				
DS = 3/8-Kreis außen schneidend DSM = mit PREMIUM-Schliff <i>DS = 3/8 circle, reverse cutting</i> <i>DSM = PREMIUM cut</i>						
DSM 11 ▽ PREMIUM-Schliff / PREMIUM cut 	6-0	0.7	0,45	ungefärbt / undyed	PA1158	24
2 x DSM 11 ▽ PREMIUM-Schliff / PREMIUM cut 	6-0	0.7	0,45	violett / violet	PA11520	24
DS 13 ▼ 	4-0	1.5	0,70	ungefärbt / undyed	PAN11422 ¹⁾	24
DSM 13 ▽ PREMIUM-Schliff / PREMIUM cut 	5-0	1	0,45	violett / violet	PA1159	24
	6-0	0.7	0,70	violett / violet	PA11512	24
	5-0	1	0,70	violett / violet	PA11511	24
	6-0	0.7	0,45	ungefärbt / undyed	PA1150	24
	5-0	1	0,45	ungefärbt / undyed	PA1151	24
	4-0	1.5	0,45	ungefärbt / undyed	PA1152	24
2 x DSM 13 ▽ PREMIUM-Schliff / PREMIUM cut 	5-0	1	0,45	violett / violet	PA11515	24
	4-0	1.5	0,45	violett / violet	PA11516	24
2 x DSM 13 S ▽ PREMIUM-Schliff / PREMIUM cut 	5-0	1	0,45	violett / violet	PA11514	24
DS 18 F ▼ 	4-0	1.5	0,70	ungefärbt / undyed	PAN11414 ¹⁾	24
DS 18 ▼ 	5-0	1	0,45	violett / violet	PA11417	24
	4-0	1.5	0,45	violett / violet	PA11418	24
	4-0	1.5	0,70	violett / violet	PA11423	24
	3-0	2	0,70	violett / violet	PA11416	24
	5-0	1	0,45	ungefärbt / undyed	PA1140	24
	4-0	1.5	0,45	ungefärbt / undyed	PA1141	24
	3-0	2	0,45	ungefärbt / undyed	PA1142	24
	4-0	1.5	0,70	ungefärbt / undyed	PA11424	24
	3-0	2	0,70	ungefärbt / undyed	PA11413	24
	3-0	2	0,45	ungefärbt / undyed	PA11413	24
DSM 18 ▽ PREMIUM-Schliff / PREMIUM cut 	5-0	1	0,70	violett / violet	PA11521	24
	4-0	1.5	0,70	violett / violet	PA11510	24
	4-0	1.5	0,45	ungefärbt / undyed	PA1154	24
	3-0	2	0,45	ungefärbt / undyed	PA1155	24
DSM 18 F ▽ PREMIUM-Schliff / PREMIUM cut 	4-0	1.5	0,45	ungefärbt / undyed	PA1153	24

PGA RESORBA®









Sterile Nadel-Faden-Kombination / *needle suture combination, sterile*

Nadel / needle	Stärke / gauge		Länge / length (m)	Farbe / colour	Best.-Nr. / code no.	Packungsinhalt / box content (Stück / pieces)
	USP	metric				
DS 24 	2-0	3	0,70	violett / violet	PA11412	24
	4-0	1.5	0,70	ungefärbt / undyed	PA1143	24
	3-0	2	0,70	ungefärbt / undyed	PA1145	24
	2-0	3	0,70	ungefärbt / undyed	PA1146	24
DSM 24  PREMIUM-Schliff / PREMIUM cut	3-0	2	0,45	violett / violet	PA11513	24
	3-0	2	0,45	ungefärbt / undyed	PA1156	24
	2-0	3	0,45	ungefärbt / undyed	PA1157	24
	4-0	1.5	0,70	ungefärbt / undyed	PA11517	24
	3-0	2	0,70	ungefärbt / undyed	PA11519	24
DS 30 	0	3.5	0,70	violett / violet	PA11411	24
	2-0	3	0,70	ungefärbt / undyed	PA1149	24
	3-0	2	0,70	ungefärbt / undyed	PA11421	24
	0	3.5	0,70	ungefärbt / undyed	PA1148	24
DS 40 	2-0	3	0,70	ungefärbt / undyed	PA11420	24
GS = Gerade schneidend <i>GS= straight, cutting</i>						
GS 12 	4-0	1.5	0,45	violett / violet	PA1175	24
	4-0	1.5	0,70	ungefärbt / undyed	PA1171	24
GS 45 	4-0	1.5	0,45	ungefärbt / undyed	PA1174	24
GS 60 	3-0	2	0,70	violett / violet	PA1177*	24
	2-0	3	0,70	violett / violet	PA1176	24
	3-0	2	0,70	ungefärbt / undyed	PA1173	24
	2-0	3	0,70	ungefärbt / undyed	PA1172	24
HSPM, HSPM F = 1/2-Kreis SPATULA, mit PREMIUM-Schliff <i>HSPM, HSPM F = 1/2 circle, spatulated, PREMIUM cut</i>						
2 x HSPM 7  PREMIUM-Schliff / PREMIUM cut	8-0	0.4	0,30	violett / violet	PAN1195 ¹⁾	12
	7-0	0.5	0,45	violett / violet	PA1194	12
2 x HSPM 8  PREMIUM-Schliff / PREMIUM cut	5-0	1	0,45	violett / violet	PA1193	24
	6-0	0.7	0,45	ungefärbt / undyed	PA1192	24

*eventuell mit verlängerter Lieferzeit verbunden / *possibly associated with an extended delivery time*

PGA RESORBA®

Sterile Nadel-Faden-Kombination / *needle suture combination, sterile*

Nadel / needle	Stärke / gauge		Länge / length (m)	Farbe / colour	Best.-Nr. / code no.	Packungsinhalt / box content (Stück / pieces)
	USP	metric				
DSPM = 3/8-Kreis SPATULA, mit PREMIUM-Schliff						
<i>DSPM = 3/8 circle, spatulated, PREMIUM cut</i>						
DSPM 6  PREMIUM-Schliff / PREMIUM cut	8-0	0.4	0,30	violett / violet	PAN1204 ¹⁾	12
	7-0	0.5	0,45	violett / violet	PAN1205 ¹⁾	24
2 x DSPM 6  PREMIUM-Schliff / PREMIUM cut	8-0	0.4	0,45	violett / violet	PAN1207 ¹⁾	12
	7-0	0.5	0,45	violett / violet	PAN1208 ¹⁾	24
2 x DSPM 7  PREMIUM-Schliff / PREMIUM cut	7-0	0.5	0,45	violett / violet	PA1201	24
2 x DSPM 8  PREMIUM-Schliff / PREMIUM cut	6-0	0.7	0,25	ungefärbt / undyed	PAN12014 ¹⁾	24
DSPM 9  PREMIUM-Schliff / PREMIUM cut	6-0	0.7	0,45	violett / violet	PAN1202 ¹⁾	24
2 x DSPM 11  PREMIUM-Schliff / PREMIUM cut	6-0	0.7	0,45	ungefärbt / undyed	PA1209	24
	4-0	1.5	0,45	ungefärbt / undyed	PA12011	24
VSPM, VSPM F = 1/4-Kreis SPATULA, mit PREMIUM-Schliff						
<i>VSPM, VSPM F = 1/4 circle, spatulated, PREMIUM cut</i>						
VSPM 6  PREMIUM-Schliff / PREMIUM cut	6-0	0.7	0,45	violett / violet	PA1214	24
2 x VSPM 8  PREMIUM-Schliff / PREMIUM cut	5-0	1	0,45	violett / violet	PAN12112 ¹⁾	24
	6-0	0.7	0,45	violett / violet	PAN12113 ¹⁾	24
2 x VSPM 8 F  PREMIUM-Schliff / PREMIUM cut	6-0	0.7	0,45	violett / violet	PA1210	24
	5-0	1	0,45	violett / violet	PAN1211 ¹⁾	24
	6-0	0.7	0,45	ungefärbt / undyed	PA1212	24
	5-0	1	0,45	ungefärbt / undyed	PA1213	24

PGA RESORBA®

Einzelfadenpackungen, steril in vorgeschrittenen Längen / *Sterile pre-cut suture, non-needed*

Stärke / gauge USP		Länge / length (m)	Farbe / colour	Best.-Nr. / code no.	Packungsinhalt / box content (Stück / pieces)
6-0	0.7	3 x 0,45	violett / violet	PS133	24
5-0	1	3 x 0,45	violett / violet	PS233	24
4-0	1.5	3 x 0,45	violett / violet	PS333	24
3-0	2	3 x 0,45	violett / violet	PS433	24
2-0	3	3 x 0,45	violett / violet	PS533	24
0	3.5	3 x 0,45	violett / violet	PS633	24
1	4	3 x 0,45	violett / violet	PS733	24
2	5	3 x 0,45	violett / violet	PS833	24
5-0	1	6 x 0,45	violett / violet	PS265	24
4-0	1.5	6 x 0,45	violett / violet	PS365	24
3-0	2	6 x 0,45	violett / violet	PS465	24
2-0	3	6 x 0,45	violett / violet	PS565	24
0	3.5	6 x 0,45	violett / violet	PS665	24
1	4	6 x 0,45	violett / violet	PS765	24
2	5	6 x 0,45	violett / violet	PS865	24
4-0	1.5	12 x 0,45	violett / violet	PS3125	24
3-0	2	12 x 0,45	violett / violet	PS4125	24
2-0	3	12 x 0,45	violett / violet	PS5125	24
0	3.5	12 x 0,45	violett / violet	PS6125	24
1	4	12 x 0,45	violett / violet	PS7125	24
2	5	12 x 0,45	violett / violet	PS8125	24
5-0	1	2 x 0,70	violett / violet	PS220	24
4-0	1.5	2 x 0,70	violett / violet	PS320	24
3-0	2	2 x 0,70	violett / violet	PS420	24
2-0	3	2 x 0,70	violett / violet	PS520	24
0	3.5	2 x 0,70	violett / violet	PS620	24
1	4	2 x 0,70	violett / violet	PS720	24
2	5	2 x 0,70	violett / violet	PS820	24
4-0	1.5	5 x 0,70	violett / violet	PS350	24
3-0	2	5 x 0,70	violett / violet	PS450	24
2-0	3	5 x 0,70	violett / violet	PS550	24
0	3.5	5 x 0,70	violett / violet	PS650	24
1	4	5 x 0,70	violett / violet	PS750	24
2	5	5 x 0,70	violett / violet	PS850	24

PGA RESORBA®

Einzelfadenpackungen, steril in vorgeschrittenen Längen / *Sterile pre-cut suture, non-needed*

Stärke / gauge USP	metric	Länge / length (m)	Farbe / colour	Best.-Nr. / code no.	Packungsinhalt / box content (Stück / pieces)
2-0	3	1 x 1,50	violett / violet	PSN515 ¹⁾	24
0	3.5	1 x 1,50	violett / violet	PSN615 ¹⁾	24
1	4	1 x 1,50	violett / violet	PSN715 ¹⁾	24
2	5	1 x 1,50	violett / violet	PSN815 ¹⁾	24
5-0	1	3 x 0,45	ungefärbt / undyed	PU233	24
4-0	1.5	3 x 0,45	ungefärbt / undyed	PU333	24
3-0	2	3 x 0,45	ungefärbt / undyed	PU433	24
2-0	3	3 x 0,45	ungefärbt / undyed	PU533	24
0	3.5	3 x 0,45	ungefärbt / undyed	PU633	24
1	4	3 x 0,45	ungefärbt / undyed	PU733	24
4-0	1.5	6 x 0,45	ungefärbt / undyed	PU365	24
3-0	2	6 x 0,45	ungefärbt / undyed	PU465	24
2-0	3	6 x 0,45	ungefärbt / undyed	PU565	24
0	3.5	6 x 0,45	ungefärbt / undyed	PU665	24
1	4	6 x 0,45	ungefärbt / undyed	PU765	24
3-0	2	12 x 0,45	ungefärbt / undyed	PU4125	24
2-0	3	12 x 0,45	ungefärbt / undyed	PU5125	24
0	3.5	12 x 0,45	ungefärbt / undyed	PU6125	24
1	4	12 x 0,45	ungefärbt / undyed	PU7125	24
2-0	3	2 x 0,70	ungefärbt / undyed	PU520	24
0	3.5	2 x 0,70	ungefärbt / undyed	PU620	24
3-0	2	5 x 0,70	ungefärbt / undyed	PU450	24
2-0	3	5 x 0,70	ungefärbt / undyed	PU550	24
0	3.5	5 x 0,70	ungefärbt / undyed	PU650	24
1	4	5 x 0,70	ungefärbt / undyed	PU750	24
4-0	1.5	1 x 2,50	violett / violet	PL100	12
3-0	2	1 x 2,50	violett / violet	PL101	12
2-0	3	1 x 2,50	violett / violet	PL102	12
0	3.5	1 x 2,50	violett / violet	PL103	12
1	4	1 x 2,50	violett / violet	PL104	12
2	5	1 x 2,50	violett / violet	PL105	12
4	6	1 x 2,50	violett / violet	PL106	12

¹⁾ Produkt hergestellt durch / product manufactured by:

 Healthium Medtech Private Limited · No. 472/D, 13th Cross, 4th Phase
Peenya Industrial Area, Bangalore 560 058, India
Mfg. Lic. No.: MFG/MD/2019/000139 · Email: care@healthiummedtech.com



- langfristig absorbierbar, synthetisch
- sehr hohe Reißkraft
- belastbarer und sicherer Knotensitz
- minimale Gewebereaktion

- *synthetic with a long period of action*
- *high tensile strength*
- *high knot security*
- *excellent biocompatibility*

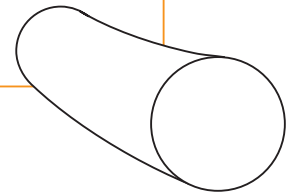

Eigenschaften:

- hohe Reißkraft
- minimale Gewebereaktion
- atraumatischer Gewebedurchzug
- guter Knotensitz

PDO RESORBA™ wird aus dem Polyester Poly (P-Dioxanon) hergestellt.

Durch das langfristige Resorptionsprofil ist PDO RESORBA™ besonders dann geeignet, wenn die Kombination aus einem resorbierbaren Faden und die Wundadaption über einen längeren Zeitraum (bis zu sechs Wochen) gewünscht wird. Nach Implantation liegt die Reißkraft nach 42 Tagen noch bei 55%. Die vollständige Resorption durch Hydrolyse ist nach etwa 25 - 31 Wochen abgeschlossen.

Gewebereaktionen werden durch die monofile Struktur des Fadens minimiert.

PDO RESORBA™ ist ungefärbt oder violett eingefärbt erhältlich.

- ➔ Farbe: ungefärbt oder violett
- ➔ Chemische Bezeichnung: Poly (P-Dioxanon)
- ➔ Fadenstärke: USP 7-0 -2 (0.5-5 metric)
- ➔ Konfektionsangebote: Nadel-Faden-Kombinationen
- ➔ Sterilisation: Ethylenoxid

Properties:

- very high tensile strength
- minimal tissue reaction
- smooth passage through tissue
- robust and high knot security

PDO RESORBA™ is made of the polyester poly (p-dioxanone).

Because of its slow degradation profile, PDO RESORBA™ is particularly useful where the combination of an absorbable suture and extended wound support (up to six weeks) is desirable. After implantation the breaking load is at 55% after 42 days. Absorption by hydrolysis is completed after about 25 - 31 weeks.







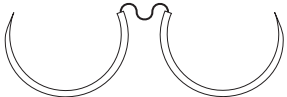
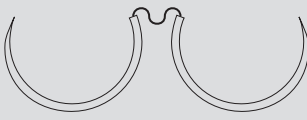

Tissue reaction is minimal because of the monofilament structure of the thread.

PDO RESORBA™ is supplied undyed or violet.

- ➔ Colour: violet or undyed
- ➔ Chemical name: poly (p-dioxanone)
- ➔ Thread diameter: USP 7-0 -2 (0.5-5 metric)
- ➔ Types of packaging: needle-thread-combinations
- ➔ Sterilization method: ethylene oxide



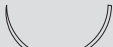

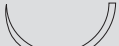

PDO RESORBA™

Sterile Nadel-Faden-Kombination / *needle suture combination, sterile*

Nadel / needle	Stärke / gauge		Länge / length (m)	Farbe / colour	Best.-Nr. / code no.	Packungsinhalt / box content (Stück / pieces)
	USP	metric				
FR = 5/8-Kreis Rundkörper <i>FR = 5/8 circle, taper point</i>						
FR 27 ● 	2-0	3	0,70	violett / violet	PN2015	24
2 x FR 27 ● 	3-0	2	0,70	violett / violet	PN2013	24
	2-0	3	0,70	violett / violet	PN2011	24
2 x FR 36 ● 	2-0	2	0,70	violett / violet	PN2014	24
HR, HRS = 1/2-Kreis Rundkörper <i>HR, HRS = 1/2 circle, taper point</i>						
HR 12 ● 	7-0	0.5	0,70	violett / violet	PN20224	24
	6-0	0.7	0,70	violett / violet	PN2021	24
	5-0	1	0,70	violett / violet	PN2022	24
	4-0	1.5	0,70	violett / violet	PN2023	24
2 x HR 12 ● 	5-0	1	0,70	violett / violet	PN2024	24
HRS 12 ● 	3-0	2	0,70	violett / violet	PN2031	24
	2-0	3	0,70	violett / violet	PN2032	24
	0	3.5	0,70	violett / violet	PN20325	24
HR 17 ● 	6-0	0.7	0,70	violett / violet	PN2025	24
	5-0	1	0,70	violett / violet	PN2026	24
	4-0	1.5	0,70	violett / violet	PN2027	24
	3-0	2	0,70	violett / violet	PN2028	24
2 x HR 17 ● 	6-0	0.7	0,70	violett / violet	PN20223	24
	5-0	1	0,70	violett / violet	PN2029	24
	4-0	1.5	0,70	violett / violet	PN20210	24
HRS 17 ● 	3-0	2	0,70	violett / violet	PN20324	24
HR 22 ● 	4-0	1.5	0,70	violett / violet	PN20211	24
	3-0	2	0,70	violett / violet	PN20212	24
2x HR 22 ● 	6-0	0.7	0,70	violett / violet	PN20239	24
	5-0	1	0,70	violett / violet	PN20238	24
	4-0	1.5	0,70	violett / violet	PN20237	24
	3-0	2	0,70	violett / violet	PN20236	24
HRS 22 ● 	2-0	3	0,70	violett / violet	PN2034	24
	0	3.5	0,70	violett / violet	PN2035	24

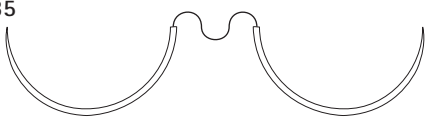

PDO RESORBA™

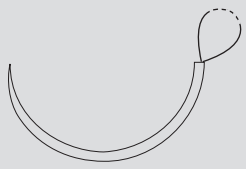
Sterile Nadel-Faden-Kombination / *needle suture combination, sterile*

Nadel / needle	Stärke / gauge USP	metric	Länge / length (m)	Farbe / colour	Best.-Nr. / code no.	Packungsinhalt / box content (Stück / pieces)
HR 27 	4-0	1.5	0,70	violett / violet	PN20213	24
	4-0	1.5	0,90	violett / violet	PN20242	24
	3-0	2	0,70	violett / violet	PN20214	24
	3-0	2	0,90	violett / violet	PN20234	24
	2-0	3	0,70	violett / violet	PN20215	24
	2-0	3	0,90	violett / violet	PN20241	24
	0	3.5	0,90	violett / violet	PN20230	24
2 x HR 27 	4-0	1.5	0,70	violett / violet	PN20217	24
	4-0	1.5	0,90	violett / violet	PN20240	24
	3-0	2	0,70	violett / violet	PN20218	24
	3-0	2	0,90	violett / violet	PN20225	24
	2-0	3	0,70	violett / violet	PN20219	24
HRS 27 	2-0	3	0,70	violett / violet	PN2036	24
	0	3.5	0,70	violett / violet	PN2037	24
	1	4	0,70	violett / violet	PN2038	24
HR 30 	1	4	0,90	violett / violet	PN20245	24
HR 35 	3-0	2	0,70	violett / violet	PN20220	24
	2-0	3	0,70	violett / violet	PN20221	24
2x HR 35 	4-0	1.5	0,70	violett / violet	PN20244	24
	3-0	2	0,70	violett / violet	PN20243	24
HRS 35 	2-0	3	0,70	violett / violet	PN2039	24
	0	3.5	0,70	violett / violet	PN20310	24
	1	4	0,70	violett / violet	PN20311	24
HRS 40 	2-0	3	0,90	violett / violet	PN20312	24
	0	3.5	0,90	violett / violet	PN20313	24
	1	4	0,90	violett / violet	PN20314	24
HRS 40 Schlinge / loop 	0	3.5	1,50	violett / violet	PN20318	24
	1	4	1,50	violett / violet	PN20319	24



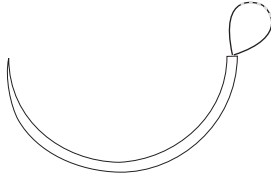
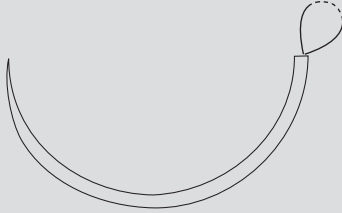
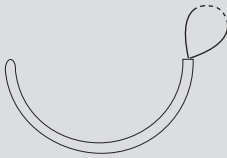

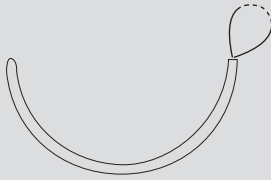



PDO RESORBA™

Sterile Nadel-Faden-Kombination / *needle suture combination, sterile*

Nadel / needle	Stärke / gauge		Länge / length (m)	Farbe / colour	Best.-Nr. / code no.	Packungsinhalt / box content (Stück / pieces)
	USP	metric				
HRS 48 ● 	0	3.5	0,90	violett / violet	PN20315	24
	1	4	0,90	violett / violet	PN20316	24
	2	5	0,90	violett / violet	PN20317	24
HRS 48 Schlinge / loop ● 	1	4	1,80	violett / violet	PN20320	24
HRS 65 Schlinge / loop ● 	1	4	2,40	violett / violet	PN20326	24
HRN = 1/2-Kreis Rundkörper stumpf <i>HRN = 1/2 circle, blunt taper point</i>						
HRN 40 Schlinge / loop ○ 	1	4	1,80	violett / violet	PN2057	24
	0	3.5	1,80	violett / violet	PN2058	24
HRN 45 ○ 	1	4	0,90	violett / violet	PN20511	24
HRN 48 Schlinge / loop ○ 	1	4	1,80	violett / violet	PN2055	24
	0	3.5	1,80	violett / violet	PN2056	24
	1	4	1,50	violett / violet	PN2059	24
	0	3.5	1,50	violett / violet	PN20510	24

PDO RESORBA™

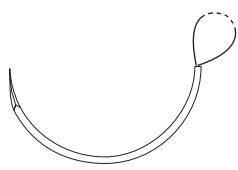
Sterile Nadel-Faden-Kombination / *needle suture combination, sterile*

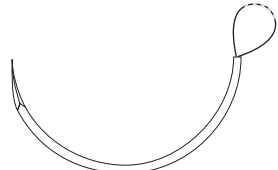
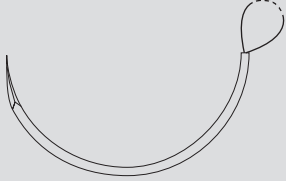
Nadel / needle	Stärke / gauge USP	gauge metric	Länge / length (m)	Farbe / colour	Best.-Nr. / code no.	Packungsinhalt / box content (Stück / pieces)
HRT = 1/2-Kreis schneidende Rundkörper <i>HRT = 1/2 circle, taper cutting</i>						
HRT 18 ▼ 	5-0	1	0,70	violett / violet	PN2061	24
	4-0	1.5	0,70	violett / violet	PN2062	24
	3-0	2	0,70	violett / violet	PN2063	24
	2-0	3	0,70	violett / violet	PN2064	24
2x HRT 18 ▼ 	4-0	1.5	0,90	violett / violet	PN20620	24
HRT 22 ▼ 	4-0	1.5	0,70	violett / violet	PN2065	24
	3-0	2	0,70	violett / violet	PN2066	24
HRT 25 ▼ 	4-0	1.5	0,70	violett / violet	PN2069	24
	3-0	2	0,70	violett / violet	PN2067	24
	2-0	3	0,70	violett / violet	PN2068	24
2x HRT 25 ▼ 	3-0	2	0,90	violett / violet	PN20619	24
HRTX 35 ▼ 	0	3.5	0,90	violett / violet	PN20612	24
HRT 40 ▼ 	2	5	0,90	violett / violet	PN20616	24
	1	4	0,90	violett / violet	PN20615	24
HRT 40 Schlinge / loop ▼ 	1	4	1,80	violett / violet	PN20617	24
HRTX 45 ▼ 	1	4	0,90	violett / violet	PN20614	24
HRT 48 Schlinge / loop ▼ 	0	3.5	1,50	violett / violet	PN20618	24
HRT 50 Schlinge / loop ▼ 	1	4	1,80	violett / violet	PN20610	24

PDO RESORBA™







Sterile Nadel-Faden-Kombination / *needle suture combination, sterile*

Nadel / needle	Stärke / gauge USP	metric	Länge / length (m)	Farbe / colour	Best.-Nr. / code no.	Packungsinhalt / box content (Stück / pieces)
DR = 3/8-Kreis Rundkörper <i>DR = 3/8 circle, taper point</i>						
2 x DR 10 ●	7-0	0.5	0,70	violett / violet	PN2071	24
		0.7	0,70	violett / violet	PN2072	24
DR 12 ●	6-0	0.7	0,70	violett / violet	PN2073	24
		1	0,70	violett / violet	PN2074	24
2 x DR 12 ●	6-0	0.7	0,70	violett / violet	PN2075	24
		1	0,70	violett / violet	PN2076	24
2 x DR 12 F ●	6-0	0.7	0,70	violett / violet	PN20710	24
DR 18 ●	2-0	3	0,30	violett / violet	PN20713	24
DR 18 ● Schlinge / loop Tsuge-Naht / Tsuge suture	4-0	1.5	0,30	violett / violet	PN2079	24
		2	0,30	violett / violet	PN2078	24
2x DR 18 ●	6-0	0.7	0,70	violett / violet	PN20712	24
		1	0,70	violett / violet	PN20711	24
DRT = 3/8-Kreis schneidende Rundkörper (Diamond-Spitze), DRTM = mit PREMIUM-Schliff <i>DRT = 3/8 circle, taper cutting</i> <i>DRTM = PREMIUM cut</i>						
DRTM 10 ⊖ PREMIUM-Schliff / PREMIUM cut	7-0	0.5	0,70	violett / violet	PN2251	24
		0.7	0,70	violett / violet	PN2252	24
2 x DRTM 10 ⊖ PREMIUM-Schliff / PREMIUM cut	6-0	0.7	0,70	violett / violet	PN2254*	24
DRTM 12 ⊖ PREMIUM-Schliff / PREMIUM cut	6-0	0.7	0,70	violett / violet	PN2255	24
		1	0,70	violett / violet	PN2256	24
2 x DRTM 12 ⊖ PREMIUM-Schliff / PREMIUM cut	6-0	0.7	0,70	violett / violet	PN2257*	24
		1	0,70	violett / violet	PN2258*	24
DRT 18 ⊖	4-0	1.5	0,45	violett / violet	PN2081	24

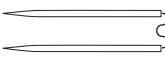
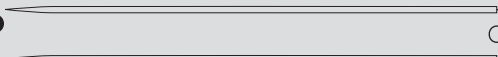
*eventuell mit verlängerter Lieferzeit verbunden / *possibly associated with an extended delivery time*













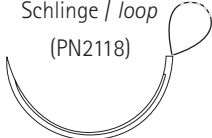

PDO RESORBA™

Sterile Nadel-Faden-Kombination / *needle suture combination, sterile*

Nadel / needle	Stärke / gauge		Länge / length (m)	Farbe / colour	Best.-Nr. / code no.	Packungsinhalt / box content (Stück / pieces)
	USP	metric				
GR = Gerade Rundkörper <i>GR = straight, taper point</i>						
GR 20 ● 	4-0	1.5	0,45	violett / violet	PN2096	24
2 x GR 20 ● 	4-0	1.5	0,35	violett / violet	PN2091	24
2 x GR 65 ● 	0	3.5	0,70	violett / violet	PN2092	24
	1	4	0,70	violett / violet	PN2093	24
2 x GRW 65 ● biegsame Nadel / flexible needle 	3-0	2	0,70	violett / violet	PN2095	24
GS = Gerade, außen schneidend <i>GS = straight, reverse cutting</i>						
GS 12 ▼ 	4-0	1.5	0,45	violett / violet	PN2173	24
ART = Asymptotische schneidende Rundkörper <i>ART = Asymptotic, taper cutting</i>						
ART 25 ▼ 	5-0	1	0,70	violett / violet	PN2282	24
	4-0	1.5	0,70	violett / violet	PN2281	24
JRT = J-förmig schneidende Rundkörper <i>JRT = J-shape taper cutting</i>						
JRT 30 ▼ 	0	3.5	0,70	violett / violet	PN2290	24
JR = J-förmige Rundkörper <i>JR = J-shape taper point</i>						
JR 36 ● 	2-0	3	0,70	violett / violet	PN2292	24









PDO RESORBA™

Sterile Nadel-Faden-Kombination / *needle suture combination, sterile*

Nadel / needle	Stärke / gauge		Länge / length (m)	Farbe / colour	Best.-Nr. / code no.	Packungsinhalt / box content (Stück / pieces)
	USP	metric				
HS = 1/2-Kreis außen schneidend <i>HS = 1/2 circle, reverse cutting</i>						
HS 27 	2-0	3	0,70	violett / violet	PN2111	24
	0	3.5	0,70	violett / violet	PN2112	24
	1	4	0,70	violett / violet	PN2113	24
HS 35   <i>Schlinge / loop (PN2118)</i>	2-0	3	1,50	violett / violet	PN2118	24
	0	3.5	0,70	violett / violet	PN2114	24
	1	4	0,70	violett / violet	PN2115	24
HS 40 	0	3.5	0,90	violett / violet	PN2116	24
HS 50 	1	4	0,90	violett / violet	PN2119	24
DS = 3/8-Kreis außen schneidend, DSM = mit PREMIUM-Schliff <i>DS = 3/8 circle, reverse cutting, DSM = PREMIUM cut</i>						
DSM 11   PREMIUM-Schliff / <i>PREMIUM cut</i>	6-0	0.7	0,45	violett / violet	PN2151	24
	6-0	0.7	0,45	ungefärbt / undyed	PN2152	24
	5-0	1	0,45	ungefärbt / undyed	PN2153	24
DS 13 	5-0	1	0,45	ungefärbt / undyed	PN21412	24
DSM 13   PREMIUM-Schliff / <i>PREMIUM cut</i>	5-0	1	0,45	violett / violet	PN2154	24
	5-0	1	0,45	ungefärbt / undyed	PN2156	24
	4-0	1.5	0,45	violett / violet	PN2155	24
	4-0	1.5	0,45	ungefärbt / undyed	PN2157	24
DSM 16   PREMIUM-Schliff / <i>PREMIUM cut</i>	5-0	1	0,45	violett / violet	PN21518	24
DS 18 	5-0	1	0,45	ungefärbt / undyed	PN2146	24
	4-0	1.5	0,45	ungefärbt / undyed	PN2141	24
	4-0	1.5	0,70	ungefärbt / undyed	PN2147	24
	3-0	2	0,45	ungefärbt / undyed	PN2142	24
	3-0	2	0,70	ungefärbt / undyed	PN2148	24
DS 18   Schlinge / <i>loop</i> <i>Tsuge-Naht / Tsuge suture</i>	4-0	1.5	0,30	violett / violet	PN2149	24

PDO RESORBA™

Sterile Nadel-Faden-Kombination / *needle suture combination, sterile*

Nadel / needle	Stärke / gauge		Länge / length (m)	Farbe / colour	Best.-Nr. / code no.	Packungsinhalt / box content (Stück / pieces)
	USP	metric				
DSM 18  PREMIUM-Schliff / <i>PREMIUM cut</i> 	4-0	1.5	0,45	violett / <i>violet</i>	PN21510	24
	4-0	1.5	0,45	ungefärbt / <i>undyed</i>	PN21512	24
	3-0	2	0,45	violett / <i>violet</i>	PN21511	24
	3-0	2	0,45	ungefärbt / <i>undyed</i>	PN21513	24
DS 24  	4-0	1.5	0,45	ungefärbt / <i>undyed</i>	PN2143	24
	3-0	2	0,45	ungefärbt / <i>undyed</i>	PN2144	24
	3-0	2	0,70	ungefärbt / <i>undyed</i>	PN21411	24
	3-0	2	0,90	violett / <i>violet</i>	PN21410	24
	2-0	3	0,45	ungefärbt / <i>undyed</i>	PN2145	24
DSM 24  PREMIUM-Schliff / <i>PREMIUM cut</i> 	4-0	1.5	0,45	ungefärbt / <i>undyed</i>	PN21514	24
	3-0	2	0,45	ungefärbt / <i>undyed</i>	PN21515	24
	2-0	3	0,45	ungefärbt / <i>undyed</i>	PN21516	24
	2-0	3	0,70	ungefärbt / <i>undyed</i>	PN21517	24
DSI = 3/8-Kreis innen schneidend <i>DSI = 3/8 circle, conventional cutting</i>						
DSI 16  	4-0	1.5	0,70	ungefärbt / <i>undyed</i>	PN2301	24



- nicht-resorbierbarer Polypropylenfaden
- dauerhaft hohe Reißfestigkeit
- hydrophob
- nicht-thrombogen
- geringste Gewebereaktion

- *non-absorbable suture*
- *high and permanent tensile strength*
- *water-repellent*
- *antithrombotic*
- *almost non-irritating*

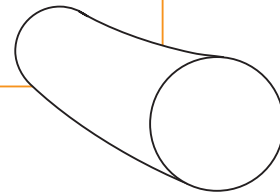

Eigenschaften:

- guter Knotensitz
- dauerhaft hohe Reißfestigkeit
- hervorragende Fadengleitfähigkeit
- hydrophob
- alterungsbeständig

MOPYLEN® ist ein synthetischer Faden, der durch Polymerisation von Propylen hergestellt wird.

Die Herstellung des Fadens erfolgt aus dem gefärbten Granulat nach dem Trockenspinverfahren.

Der Faden ist hydrophob, hat also praktisch keine Wasserabsorption und ist chemisch inert. MOPYLEN® ist ein idealer Hautfaden speziell für plastische Chirurgie und überall, wo es auf ein besonders gutes kosmetisches Ergebnis ankommt.

Das Material ist mit einem physiologisch unbedenklichen Farbstoff eingefärbt.

- Farbe: blau
- Chemische Bezeichnung: isotaktisches Polypropylen
- Fadenstärke: USP 10-0 –2 (0.2-5 metric)
- Konfektionsangebote:
 - Nadel-Faden-Kombinationen
- Sterilisation: Ethylenoxid

Properties:

- excellent knot security
- consistently high tear resistance
- excellent tissue passage
- hydrophobic
- non-ageing

MOPYLEN® is a synthetic suture, which is manufactured by polymerising propylene.

The suture is produced from the dyed granules using the dry spinning process.

The suture is hydrophobic, i.e., it absorbs practically no water and is chemically inert.













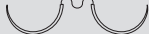

MOPYLEN® is an ideal skin suture, especially in plastic surgery and anywhere, where an excellent cosmetic result is critical.

The material is coloured with a physiologically harmless dye.

- Colour: blue
- Chemical name: isotactic polypropylene
- Thread diameter: USP 10-0 –2 (0.2-5 metric)
- Types of packaging:
 - needle-thread-combinations
- Sterilization method: ethylene oxide

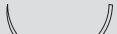

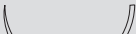



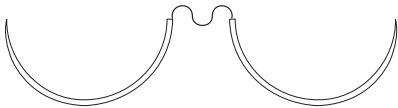

MOPYLEN®

Sterile Nadel-Faden-Kombination / *needle suture combination, sterile*

Nadel / needle	Stärke / gauge		Länge / length (m)	Farbe / colour	Best.-Nr. / code no.	Packungsinhalt / box content (Stück / pieces)
	USP	metric				
HR, HRS = 1/2-Kreis Rundkörper <i>HR, HRS = 1/2 circle, taper point</i>						
2 x HR 6 ● 	7-0	0.5	0,45	blau / blue	70235N ¹⁾	24
	6-0	0.7	0,45	blau / blue	70236N ¹⁾	24
HR 8 ● 	7-0	0.5	0,30	blau / blue	70223N ¹⁾	24
	6-0	0.7	0,30	blau / blue	70224N ¹⁾	24
2 x HR 8 ● 	7-0	0.5	0,45	blau / blue	70225N ¹⁾	24
	6-0	0.7	0,45	blau / blue	70226N ¹⁾	24
HR 10 ● 	6-0	0.7	0,45	blau / blue	70230	36
2 x HR 10 ● 	6-0	0.7	0,75	blau / blue	70231	36
HR 12 ● 	5-0	1	0,75	blau / blue	70232	36
2 x HR 12 ● 	6-0	0.7	0,75	blau / blue	7022	36
	5-0	1	0,75	blau / blue	7023	36
	4-0	1.5	0,90	blau / blue	7024	36
2 x HR 15 ● 	6-0	0.7	0,75	blau / blue	7025	36
	5-0	1	0,75	blau / blue	7026	36
HR 17 ● 	5-0	1	0,75	blau / blue	7027	36
	4-0	1.5	0,75	blau / blue	7028	36
	3-0	2	0,75	blau / blue	7029	36
2 x HR 17 ● 	5-0	1	0,90	blau / blue	70210	36
	4-0	1.5	0,90	blau / blue	70211	36
	3-0	2	0,90	blau / blue	70212	36
HR 22 ● 	4-0	1.5	0,75	blau / blue	70213	36
	3-0	2	0,75	blau / blue	70214	36
2 x HR 22 ● 	4-0	1.5	0,90	blau / blue	70215	36
	3-0	2	0,90	blau / blue	70216	36
HR 27 ● 	4-0	1.5	0,75	blau / blue	70238	36
	3-0	2	0,75	blau / blue	70217	36
	2-0	3	0,75	blau / blue	70218	36
	0	3.5	0,75	blau / blue	70219	36
2 x HR 27 ● 	5-0	1	0,75	blau / blue	70237	36
	4-0	1.5	0,90	blau / blue	70220	36
	3-0	2	0,90	blau / blue	70221	36
	2-0	3	0,90	blau / blue	70222	36
	4-0	1.5	1,20	blau / blue	70239	36
	3-0	2	1,20	blau / blue	70240	36

MOPYLEN®

Sterile Nadel-Faden-Kombination / *needle suture combination, sterile*

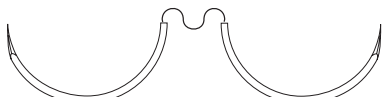
Nadel / needle	Stärke / gauge		Länge / length	Farbe / colour	Best.-Nr. / code no.	Packungsinhalt / box content (Stück / pieces)
	USP	metric				
HRS 27 ● 	2-0	3	0,75	blau / blue	7031	36
	0	3.5	0,75	blau / blue	7032	36
2 x HR 35 ● 	3-0	2	0,90	blau / blue	70241	36
HRS 35 ● 	2-0	3	0,75	blau / blue	7033	36
	0	3.5	0,75	blau / blue	7034	36
	1	4	0,75	blau / blue	7035	36
HRT = 1/2-Kreis schneidende Rundkörper <i>HRT = 1/2 circle, taper cutting</i>						
2 x HRT 13 ▼ 	5-0	1	0,60	blau / blue	70624	36
	4-0	1.5	0,75	blau / blue	70625	36
HRT 18 ▼ 	5-0	1	0,75	blau / blue	7061	36
	4-0	1.5	0,75	blau / blue	7062	36
	3-0	2	0,75	blau / blue	7063*	36
2 x HRT 18 ▼ 	5-0	1	0,90	blau / blue	70612	36
	4-0	1.5	0,90	blau / blue	7064	36
	3-0	2	0,90	blau / blue	7065	36
	2-0	3	0,90	blau / blue	7066	36
HRT 22 ▼ 	4-0	1.5	0,75	blau / blue	70613	36
	3-0	2	0,75	blau / blue	70614	36
	2-0	3	0,75	blau / blue	70615	36
2 x HRT 22 ▼ 	4-0	1.5	0,90	blau / blue	70616	36
HRT 25 ▼ 	3-0	2	0,75	blau / blue	7068	36
	2-0	3	0,75	blau / blue	7069	36
2 x HRT 25 ▼ 	3-0	2	0,90	blau / blue	70610	36
	2-0	3	0,90	blau / blue	70611	36
	3-0	2	1,20	blau / blue	70619*	36
2 x HRT 30 ▼ 	3-0	2	0,90	blau / blue	70623	36
	2-0	3	0,90	blau / blue	70622	36

*eventuell mit verlängerter Lieferzeit verbunden / *possibly associated with an extended delivery time*

MOPYLEN®

Sterile Nadel-Faden-Kombination / *needle suture combination, sterile*

Nadel / needle	Stärke / gauge USP	gauge metric	Länge / length	Farbe / colour	Best.-Nr. / code no.	Packungsinhalt / box content (Stück / pieces)
DR, DR F = 3/8-Kreis Rundkörper <i>DR, DR F = 3/8 circle, taper point</i>						
DR 5 F ●	10-0	0.2	0,15	blau / blue	70726N ¹⁾	24
DR 6 ●	9-0	0.3	0,15	blau / blue	7072N ¹⁾	24
2 x DR 6 ●	8-0	0.4	0,45	blau / blue	70736N ¹⁾	24
	8-0	0.4	0,75	blau / blue	70732N ¹⁾	24
DR 10 F	7-0	0.5	0,75	blau / blue	7074	36
	6-0	0.7	0,75	blau / blue	70725	36
2 x DR 10 F ●	7-0	0.5	0,75	blau / blue	7076	36
	6-0	0.7	0,75	blau / blue	7077	36
DR 12 ●	5-0	1	0,75	blau / blue	7079	36
	4-0	1.5	0,75	blau / blue	70710	36
2 x DR 12 ●	5-0	1	0,75	blau / blue	70712	36
	4-0	1.5	0,75	blau / blue	70713	36
	5-0	1	0,90	blau / blue	70714	36
DR 12 F ●	6-0	0.7	0,75	blau / blue	7078	36
2 x DR 12 F ●	7-0	0.5	0,60	blau / blue	70735	36
	6-0	0.7	0,75	blau / blue	70711	36
	5-0	1	0,75	blau / blue	70737	36
DR 18 ●	5-0	1	0,75	blau / blue	70715	36
	4-0	1.5	0,75	blau / blue	70716	36
	3-0	2	0,75	blau / blue	70719	36
2 x DR 18 ●	5-0	1	0,90	blau / blue	70717	36
	4-0	1.5	0,90	blau / blue	70718	36
	3-0	2	0,90	blau / blue	70720	36
DR 18 ● Schlinge / loop <i>Tsuge-Naht / Tsuge suture</i>	4-0	1.5	0,30	blau / blue	70734	36
	3-0	2	0,30	blau / blue	70733	36

MOPYLEN®









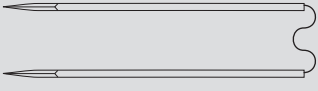

Sterile Nadel-Faden-Kombination / *needle suture combination, sterile*

Nadel / needle	Stärke / gauge USP	gauge metric	Länge / length	Farbe / colour	Best.-Nr. / code no.	Packungsinhalt / box content (Stück / pieces)
DRT = 3/8-Kreis schneidende Rundkörper						
DRTM = mit PREMIUM-Schliff						
<i>DRT = 3/8 circle, taper cutting,</i>						
<i>DRTM = PREMIUM cut</i>						
DRTM 10 ▽	7-0	0,5	0,75	blau / blue	7251	24
	6-0	0,7	0,75	blau / blue	7252	24
PREMIUM-Schliff / <i>PREMIUM cut</i>						
2 x DRTM 10 ▽	5-0	1	0,60	blau / blue	72513	24
	7-0	0,5	0,75	blau / blue	7253	24
PREMIUM-Schliff / <i>PREMIUM cut</i>						
DRT 12 ▽	6-0	0,7	0,75	blau / blue	7081	36
	5-0	1	0,75	blau / blue	7082	36
2 x DRT 12 ▽	6-0	0,7	0,75	blau / blue	7083N ¹⁾	24
	5-0	1	0,75	blau / blue	7084N ¹⁾	24
DRTM 12 ▽	6-0	0,7	0,75	blau / blue	7258	24
PREMIUM-Schliff / <i>PREMIUM cut</i>						
2 x DRTM 12 ▽	6-0	0,7	0,45	blau / blue	72511	24
	7-0	0,5	0,60	blau / blue	72514	24
PREMIUM-Schliff / <i>PREMIUM cut</i>						
	6-0	0,7	0,75	blau / blue	72510	24
	5-0	1	0,75	blau / blue	72512	24
	5-0	1	0,90	blau / blue	7259*	24
DRT 18 ▽	5-0	1	0,75	blau / blue	7088	36
	4-0	1,5	0,75	blau / blue	7089	36
	3-0	2	0,75	blau / blue	70810	36
GR = Gerade Rundkörper						
<i>GR = straight, taper point</i>						
2 x GR 20 ●	4-0	1,5	0,35	blau / blue	7091	36
2 x GR 45 ●	3-0	2	0,35	blau / blue	7092	36
2 x GR 65 ●	2-0	3	0,75	blau / blue	7094	36

*eventuell mit verlängerter Lieferzeit verbunden / *possibly associated with an extended delivery time*









MOPYLEN®

Sterile Nadel-Faden-Kombination / *needle suture combination, sterile*

Nadel / needle	Stärke / gauge		Länge / length	Farbe / colour	Best.-Nr. / code no.	Packungsinhalt / box content (Stück / pieces)
	USP	metric				
GRT = Gerade schneidende Rundkörper <i>GRT = straight, taper cutting</i>						
2 x GRT 40 ☉ 	4-0	1.5	0,35	blau / blue	7102	36
HS = 1/2-Kreis außen schneidend HSM = mit PREMIUM-Schliff <i>HS = 1/2 circle, reverse cutting, HSM = PREMIUM cut</i>						
HSM 17 ▽ PREMIUM-Schliff / PREMIUM cut 	4-0	1.5	0,45	blau / blue	7126	36
HS 18 ▼ 	3-0	2	0,45	blau / blue	7111	36
HS 27 ▼ 	2-0	3	0,75	blau / blue	7112	36
	0	3.5	0,75	blau / blue	7113	36
DS, DS F = 3/8-Kreis außen schneidend DSM, DSM F = mit PREMIUM-Schliff <i>DS, DS F = 3/8 circle, reverse cutting</i> <i>DSM, DSM F = PREMIUM cut</i>						
DSM 7 ▽ PREMIUM-Schliff / PREMIUM cut 	7-0	0.5	0,45	blau / blue	7151	36
	6-0	0.7	0,45	blau / blue	71525	36
DSM 11 ▽ PREMIUM-Schliff / PREMIUM cut 	7-0	0.5	0,45	blau / blue	71526	36
	6-0	0.7	0,45	blau / blue	7152	36
	5-0	1	0,45	blau / blue	7153	36
DSM 11 F ▽ PREMIUM-Schliff / PREMIUM cut 	6-0	0.7	0,45	blau / blue	71555	36
DS 13 ▼ 	5-0	1	0,45	blau / blue	7141	36
	4-0	1.5	0,45	blau / blue	7142	36
DSM 13 ▽ PREMIUM-Schliff / PREMIUM cut 	6-0	0.7	0,45	blau / blue	7155	36
	5-0	1	0,45	blau / blue	7156	36
	4-0	1.5	0,45	blau / blue	7157	36
	5-0	1	0,45	blau / blue	7145	36
DS 16 ▼ 	4-0	1.5	0,45	blau / blue	71446	36
	6-0	0.7	0,45	blau / blue	71530	36
DSM 16 ▽ PREMIUM-Schliff / PREMIUM cut 	5-0	1	0,45	blau / blue	71510	36
	4-0	1.5	0,45	blau / blue	71511	36









MOPYLEN®

Sterile Nadel-Faden-Kombination / *needle suture combination, sterile*

Nadel / needle	Stärke / gauge USP	metric	Länge / length	Farbe / colour	Best.-Nr. / code no.	Packungsinhalt / box content (Stück / pieces)
DS 18 	5-0	1	0,45	blau / blue	7147	36
	4-0	1.5	0,45	blau / blue	7148	36
	3-0	2	0,45	blau / blue	7149	36
	4-0	1.5	0,75	blau / blue	71410	36
	3-0	2	0,75	blau / blue	71411	36
DS 18 ▼ Schlinge / loop Tsuge-Naht / <i>Tsuge Suture</i> 	4-0	1.5	0,30	blau / blue	71447	36
	3-0	2	0,30	blau / blue	71448	36
DS 18 F ▼ 	4-0	1.5	0,45	blau / blue	71436	36
	4-0	1.5	0,75	blau / blue	71437	36
DSM 18 F ▽ PREMIUM-Schliff / <i>PREMIUM cut</i> 	4-0	1.5	0,45	blau / blue	71550	36
	4-0	1.5	0,75	blau / blue	71551	36
DSM 18 ▽ PREMIUM-Schliff / <i>PREMIUM cut</i> 	5-0	1	0,45	blau / blue	71512	36
	4-0	1.5	0,45	blau / blue	71513	36
	3-0	2	0,45	blau / blue	71514	36
	2-0	3	0,45	blau / blue	71515	36
	4-0	1.5	0,75	blau / blue	71516	36
	3-0	2	0,75	blau / blue	71517	36
	2-0	3	0,75	blau / blue	71518	36
DS 21 ▼ 	4-0	1.5	0,45	blau / blue	71427	36
	3-0	2	0,45	blau / blue	71428	36
	2-0	3	0,45	blau / blue	71429	36
	4-0	1.5	0,75	blau / blue	71430	36
	3-0	2	0,75	blau / blue	71431	36
	2-0	3	0,75	blau / blue	71432	36
DSM 21 ▽ PREMIUM-Schliff / <i>PREMIUM cut</i> 	4-0	1.5	0,45	blau / blue	71536	36
	3-0	2	0,45	blau / blue	71537	36
	2-0	3	0,45	blau / blue	71538	36
	4-0	1.5	0,75	blau / blue	71539	36
	3-0	2	0,75	blau / blue	71540	36
	2-0	3	0,75	blau / blue	71541	36
DS 24 ▼ 	4-0	1.5	0,45	blau / blue	71414	36
	3-0	2	0,45	blau / blue	71415	36
	2-0	3	0,45	blau / blue	71425	36
	3-0	2	0,75	blau / blue	71416	36
	2-0	3	0,75	blau / blue	71426	36

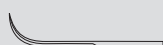

MOPYLEN®

Sterile Nadel-Faden-Kombination / *needle suture combination, sterile*

Nadel / needle	Stärke / gauge		Länge / length	Farbe / colour	Best.-Nr. / code no.	Packungsinhalt / box content (Stück / pieces)
	USP	metric				
DSM 24  PREMIUM-Schliff / <i>PREMIUM cut</i>	4-0	1.5	0,45	blau / blue	71520	36
	3-0	2	0,45	blau / blue	71521	36
	2-0	3	0,45	blau / blue	71522	36
	4-0	1.5	0,75	blau / blue	71531	36
	3-0	2	0,75	blau / blue	71523	36
	2-0	3	0,75	blau / blue	71524	36
DS 27 	2-0	3	0,45	blau / blue	71418	36
	2-0	3	0,75	blau / blue	71433	36
DSM 27  PREMIUM-Schliff / <i>PREMIUM cut</i>	2-0	3	0,45	blau / blue	71542	36
	2-0	3	0,75	blau / blue	71543	36
DS 30 	2-0	3	0,45	blau / blue	71421	36
	0	3.5	0,45	blau / blue	71422	36
	4-0	1.5	0,75	blau / blue	71419	36
	3-0	2	0,75	blau / blue	71420	36
	2-0	3	0,75	blau / blue	71424	36
DSM 30  PREMIUM-Schliff / <i>PREMIUM cut</i>	0	3.5	0,45	blau / blue	71547	36
	3-0	2	0,75	blau / blue	71544	36
	2-0	3	0,75	blau / blue	71546	36
DS 40 	2-0	3	0,75	blau / blue	71434	36
	0	3.5	0,75	blau / blue	71423	36
KS = 1/2-gebogen außen schneidend <i>KS = 1/2 curved, reverse cutting</i>						
KS 20 	3-0	2	0,45	blau / blue	7181	36
GS = Gerade schneidend <i>GS = straight, cutting</i>						
GS 12 	4-0	1.5	0,45	blau / blue	7171	36
GS 60 	3-0	2	0,75	blau / blue	7172	36

MOPYLEN®

Sterile Nadel-Faden-Kombination / *needle suture combination, sterile*

Nadel / needle	Stärke / gauge USP	gauge metric	Länge / length	Farbe / colour	Best.-Nr. / code no.	Packungsinhalt / box content (Stück / pieces)
GSPM = Gerade SPATULA, PREMIUM-Schliff						
<i>GSPM = straight, spatulated, PREMIUM cut</i>						
2 x GSPM 16  PREMIUM-Schliff / PREMIUM cut	10-0	0.2	0,20	blau / blue	7261N ¹⁾	24
DSPM = 3/8-Kreis SPATULA, PREMIUM-Schliff						
<i>DSPM = 3/8 circle, spatulated, PREMIUM cut</i>						
2 x DSPM 7  PREMIUM-Schliff / PREMIUM cut	10-0	0.2	0,15	blau / blue	7208N ¹⁾	24

¹⁾ Produkt hergestellt durch / *product manufactured by:*



Healthium Medtech Private Limited · No. 472/D, 13th Cross, 4th Phase
Peenya Industrial Area, Bangalore 560 058, India
Mfg. Lic. No.: MFG/MD/2019/000139 · Email: care@healthiummedtech.com



- nicht-resorbierbarer PVDF-Faden
- chemisch inert
- hydrophob
- keinerlei Gewebereaktion

- *non-absorbable PVDF suture*
- *absolutely inert*
- *hydrophobic*
- *non-irritating*

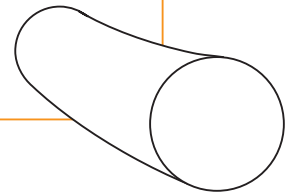

Eigenschaften:

- hydrophob, flexibel und elastisch
- sehr gute Fadengleitfähigkeit
- besonders hohe Geschmeidigkeit
- chemisch inert
- extrem alterungsbeständig

RESOPREN® ist ein monofiler, blauer Kunststofffaden aus Polyvinylidendifluorid (PVDF). Der Faden wird aus dem gefärbten Granulat im Trockenspinverfahren hergestellt.

RESOPREN® ist chemisch inert, Wasser abstoßend, extrem alterungsbeständig.

Das Material ist mit einem physiologisch unbedenklichen Farbstoff eingefärbt.

- Farbe: blau
- Chemische Bezeichnung: Polyvinylidendifluorid
- Fadenstärke: USP 7-0 -2 (0.5-5 metric)
- Konfektionsangebote:
 - Nadel-Faden-Kombinationen
- Sterilisation: Ethylenoxid

Properties:

- hydrophobic, flexible and elastic
- excellent tissue passage
- extremely supple
- chemically inert
- extremely resistant to aging

RESOPREN® is a blue, monofilament, synthetic suture made of polyvinylidene difluoride (PVDF). The suture is produced from the dyed granules using the dry spinning process.











RESOPREN® is chemically inert, hydrophobic and highly resistant to ageing.

The material is coloured with a physiologically harmless dye.

- Colour: blue
- Chemical name: polyvinylidene difluoride
- Thread diameter: USP 7-0 -2 (0.5-5 metric)
- Types of packaging:
 - needle-thread-combinations
- Sterilization method: ethylene oxide

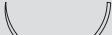

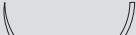

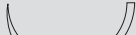







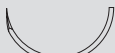

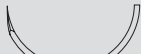
RESOPREN®

Sterile Nadel-Faden-Kombination / *needle suture combination, sterile*

Nadel / needle	Stärke / gauge		Länge / length (m)	Farbe / colour	Best.-Nr. / code no.	Packungsinhalt / box content (Stück / pieces)
	USP	metric				
HR, HRS = 1/2-Kreis Rundkörper <i>HR, HRS = 1/2 circle, taper point</i>						
HR 10 ● 	6-0	0.7	0,45	blau / blue	77021	36
2 x HR 10 ● 	6-0	0.7	0,75	blau / blue	77022	36
2 x HR 12 ● 	6-0	0.7	0,75	blau / blue	77023	36
	5-0	1	0,75	blau / blue	77024	36
	4-0	1.5	0,90	blau / blue	77025	36
2 x HR 15 ● 	6-0	0.7	0,75	blau / blue	77026	36
	5-0	1	0,75	blau / blue	77027	36
HR 17 ● 	5-0	1	0,75	blau / blue	770210	36
	4-0	1.5	0,75	blau / blue	770211	36
	3-0	2	0,75	blau / blue	770212	36
2 x HR 17 ● 	5-0	1	0,90	blau / blue	770213	36
	4-0	1.5	0,90	blau / blue	770214	36
	3-0	2	0,90	blau / blue	770215	36
HR 22 ● 	4-0	1.5	0,75	blau / blue	770216	36
	3-0	2	0,75	blau / blue	770217	36
2 x HR 22 ● 	4-0	1.5	0,90	blau / blue	770218	36
	3-0	2	0,90	blau / blue	770219	36
HR 27 ● 	3-0	2	0,75	blau / blue	770220	36
	2-0	3	0,75	blau / blue	770221	36
2 x HR 27 ● 	4-0	1.5	0,90	blau / blue	770222	36
	3-0	2	0,90	blau / blue	770223	36
	2-0	3	0,90	blau / blue	770224	36
HRS 27 ● 	2-0	3	0,75	blau / blue	770227	36
	0	3.5	0,75	blau / blue	770228	36













RESOPREN®

Sterile Nadel-Faden-Kombination / *needle suture combination, sterile*

Nadel / needle	Stärke / gauge USP	gauge metric	Länge / length (m)	Farbe / colour	Best.-Nr. / code no.	Packungsinhalt / box content (Stück / pieces)
HRT = 1/2-Kreis schneidende Rundkörper <i>HRT = 1/2 circle, taper cutting</i>						
HRT 18 ▼ 	5-0	1	0,75	blau / blue	77061	36
	4-0	1.5	0,75	blau / blue	77062	36
	3-0	2	0,75	blau / blue	77063	36
2x HRT 18 ▼ 	5-0	1	0,90	blau / blue	77064	36
	4-0	1.5	0,90	blau / blue	77065	36
	3-0	2	0,90	blau / blue	77066	36
	2-0	3	0,90	blau / blue	77067	36
HRT 22 ▼ 	4-0	1.5	0,75	blau / blue	77068	36
	3-0	2	0,75	blau / blue	77069	36
	2-0	3	0,75	blau / blue	770610	36
2 x HRT 22 ▼ 	4-0	1.5	0,90	blau / blue	770611	36
HRT 25 ▼ 	3-0	2	0,75	blau / blue	770615	36
	2-0	3	0,75	blau / blue	770616	36
	0	3.5	0,75	blau / blue	770621	36
2 x HRT 25 ▼ 	3-0	2	0,90	blau / blue	770617	36
	2-0	3	0,90	blau / blue	770618	36
DR, DR F = 3/8-Kreis Rundkörper <i>DR, DR F = 3/8 circle, taper point</i>						
DR 10 ● 	6-0	0.7	0,75	blau / blue	77074	36
2 x DR 10 ● 	6-0	0.7	0,75	blau / blue	77075	36
DR 10 F ● 	7-0	0.5	0,75	blau / blue	77071	36
2 x DR 10 F ● 	7-0	0.5	0,75	blau / blue	77072	36
DR 12 ● 	5-0	1	0,75	blau / blue	770711	36
	4-0	1.5	0,75	blau / blue	770712	36
2 x DR 12 ● 	5-0	1	0,75	blau / blue	770713	36
	4-0	1.5	0,75	blau / blue	770714	36
	5-0	1	0,90	blau / blue	770715	36
DR 12 F ● 	6-0	0.7	0,75	blau / blue	77078	36
2 x DR 12 F ● 	6-0	0.7	0,75	blau / blue	77079	36

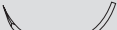







RESOPREN®

Sterile Nadel-Faden-Kombination / *needle suture combination, sterile*

Nadel / needle	Stärke / gauge		Länge / length (m)	Farbe / colour	Best.-Nr. / code no.	Packungsinhalt / box content (Stück / pieces)	
	USP	metric					
DR 18 ●		5-0	1	0,75	blau / blue	770718	36
		4-0	1.5	0,75	blau / blue	770719	36
		3-0	2	0,75	blau / blue	770720	36
2 x DR 18 ●		5-0	1	0,90	blau / blue	770721	36
		4-0	1.5	0,90	blau / blue	770722	36
		3-0	2	0,90	blau / blue	770723	36
DRT = 3/8-Kreis schneidende Rundkörper DRTM = mit PREMIUM-Schliff <i>DRT = 3/8 circle, taper cutting,</i> <i>DRTM = PREMIUM cut</i>							
DRTM 10 ⊖ PREMIUM-Schliff / PREMIUM cut		7-0	0.5	0,75	blau / blue	77251	24
		6-0	0.7	0,75	blau / blue	77252	24
2 x DRTM 10 ⊖ PREMIUM-Schliff / PREMIUM cut		7-0	0.5	0,75	blau / blue	77253	24
		6-0	0.7	0,75	blau / blue	77255	24
DRT 12 ⊖		6-0	0.7	0,75	blau / blue	77081	36
		5-0	1	0,75	blau / blue	77082	36
2x DRT 12 ⊖		6-0	0.7	0,75	blau / blue	77083	36
		5-0	1	0,75	blau / blue	77084	36
DRTM 12 ⊖ PREMIUM-Schliff / PREMIUM cut		6-0	0.7	0,75	blau / blue	77257	24
		5-0	1	0,75	blau / blue	77258	24
2 x DRTM 12 ⊖ PREMIUM-Schliff / PREMIUM cut		6-0	0.7	0,75	blau / blue	772510	24
		5-0	1	0,75	blau / blue	772511	24
DRT 18 ⊖		5-0	1	0,75	blau / blue	77086	36
		4-0	1.5	0,75	blau / blue	77087	36
		3-0	2	0,75	blau / blue	77088	36
DS = 3/8-Kreis außen schneidend DSM, DSM F = mit PREMIUM-Schliff <i>DS = 3/8 circle, reverse cutting</i> <i>DSM, DSM F = PREMIUM cut</i>							
DSM 7 ▽ PREMIUM-Schliff / PREMIUM cut		7-0	0.5	0,45	blau / blue	771518	36
		6-0	0.7	0,45	blau / blue	771519	36
DSM 11 ▽ PREMIUM-Schliff / PREMIUM cut		6-0	0.7	0,45	blau / blue	771520	36
DS 13 ▼		5-0	1	0,45	blau / blue	771411	36

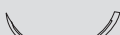

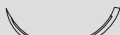

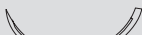

RESOPREN®

Sterile Nadel-Faden-Kombination / *needle suture combination, sterile*

Nadel / needle	Stärke / gauge USP	gauge metric	Länge / length (m)	Farbe / colour	Best.-Nr. / code no.	Packungsinhalt / box content (Stück / pieces)	
DSM 13 ▽ PREMIUM-Schliff / PREMIUM cut		6-0	0,7	0,45	blau / blue	771526	36
		5-0	1	0,45	blau / blue	771517	36
		4-0	1,5	0,45	blau / blue	771527	36
DS 16 ▼		5-0	1	0,45	blau / blue	771415	36
		4-0	1,5	0,45	blau / blue	771412	36
DSM 16 ▽ PREMIUM-Schliff / PREMIUM cut		5-0	1	0,45	blau / blue	771525	36
		4-0	1,5	0,45	blau / blue	77151	36
DSM 16 F ▽ PREMIUM-Schliff / PREMIUM cut		5-0	1	0,45	blau / blue	771535	36
DS 18 ▼		5-0	1	0,45	blau / blue	771401	36
		4-0	1,5	0,45	blau / blue	771402	36
		3-0	2	0,45	blau / blue	771403	36
		4-0	1,5	0,75	blau / blue	771416	36
		3-0	2	0,75	blau / blue	771417	36
DSM 18 ▽ PREMIUM-Schliff / PREMIUM cut		5-0	1	0,45	blau / blue	77152	36
		4-0	1,5	0,45	blau / blue	77153	36
		3-0	2	0,45	blau / blue	77154	36
		4-0	1,5	0,75	blau / blue	771529	36
		3-0	2	0,75	blau / blue	77155	36
		2-0	3	0,75	blau / blue	771530	36
DSM 18 F ▽ PREMIUM-Schliff / PREMIUM cut		4-0	1,5	0,45	blau / blue	771521	36
DS 21 ▼		3-0	2	0,45	blau / blue	771420	36
		2-0	3	0,45	blau / blue	771421	36
		3-0	2	0,75	blau / blue	771422	36
		2-0	3	0,75	blau / blue	771423	36
DSM 21 ▽ PREMIUM-Schliff / PREMIUM cut		3-0	2	0,45	blau / blue	771534	36
		4-0	1,5	0,75	blau / blue	771523	36
		3-0	2	0,75	blau / blue	771524	36

RESOPREN®

Sterile Nadel-Faden-Kombination / *needle suture combination, sterile*

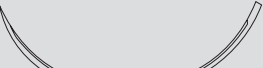
Nadel / needle	Stärke / gauge USP	metric	Länge / length (m)	Farbe / colour	Best.-Nr. / code no.	Packungsinhalt / box content (Stück / pieces)
DS 24 ▼ 	4-0	1.5	0,45	blau / blue	771418	36
	3-0	2	0,45	blau / blue	771406	36
	2-0	3	0,45	blau / blue	771419	36
	3-0	2	0,75	blau / blue	771407	36
	2-0	3	0,75	blau / blue	771408	36
DSM 24 ▽ PREMIUM-Schliff / <i>PREMIUM cut</i> 	4-0	1.5	0,45	blau / blue	771531	36
	3-0	2	0,45	blau / blue	77158	36
	2-0	3	0,45	blau / blue	771532	36
	3-0	2	0,75	blau / blue	77159	36
	2-0	3	0,75	blau / blue	771510	36
DS 27 ▼ 	2-0	3	0,45	blau / blue	771425	36
	2-0	3	0,75	blau / blue	771426	36
DS 30 ▼ 	3-0	2	0,75	blau / blue	771424	36
	2-0	3	0,75	blau / blue	771413	36
	0	3.5	0,75	blau / blue	771414	36
DSM 30 ▽ PREMIUM-Schliff / <i>PREMIUM cut</i> 	3-0	2	0,75	blau / blue	771513	36
	2-0	3	0,75	blau / blue	771514	36
	0	3.5	0,75	blau / blue	771515	36
DS 40 ▼ 	2-0	3	0,75	blau / blue	771427	36
	0	3.5	0,75	blau / blue	771428	36
DSM 40 ▽ PREMIUM-Schliff / <i>PREMIUM cut</i> 	0	3.5	0,75	blau / blue	771516	36

POLYESTER



- nicht-resorbierbarer Polyesterfaden
- extrem zugfest
- hydrophob
- alterungsbeständig
- geringe Gewebereaktion

- *non-absorbable polyester suture*
- *high and permanent tensile strength*
- *hydrophobic*
- *non-ageing*
- *minimal tissue reactions*

POLYESTER

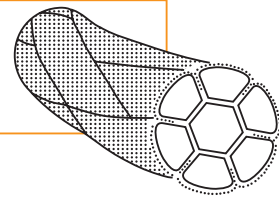

Eigenschaften:

- sehr hohe Reißfestigkeit
- hervorragende Fadengleitfähigkeit
- guter Knotensitz

POLYESTER wird durch Polykondensation von Ethylenglykol und Terephthalsäure hergestellt.

Die Faserbildung erfolgt nach dem Trockenspinnverfahren. Anschließend werden die gereckten, leicht verdrehten Faserbündel zu einem Faden präzisionsgeflochten und getempert. Der einzelne Faden ist hydrophob, nimmt also kein Wasser auf.

Das Material ist mit einem physiologisch unbedenklichen Farbstoff eingefärbt.

- Farbe: grün, weiß (ohne Farbstoff)
- Chemische Bezeichnung: Polyethylenterephthalat-Polyesterfaser
- Fadenstärke: USP 6-0 -6 (0.7-8 metric)
- Konfektionsangebote:
 - Nadel-Faden-Kombinationen
 - in vorgeschrittenen Längen
- Sterilisation: Ethylenoxid

Properties:

- very high tear resistance
- excellent tissue passage
- high knot security

POLYESTER is produced by polycondensation of ethylene glycol and terephthalic acid.











Fibres are formed using the dry spinning process. Precisionbraiding and tempering transform the stretched, slightly twisted fibre bundles into a suture. The individual fibres are hydrophobic, i.e., they repel water.

The material is coloured with a physiologically harmless dye.

- Colour: green, white (no dye)
- Chemical name: polyethylene terephthalate polyester fibre
- Thread diameter: USP 6-0 -6 (0.7-8 metric)
- Types of packaging:
 - needle-thread-combinations
 - pre-cut lengths
- Sterilization method: ethylene oxide

POLYESTER

Sterile Nadel-Faden-Kombination / *needle suture combination, sterile*







Nadel / needle	Stärke / gauge		Länge / length (m)	Farbe / colour	Best.-Nr. / code no.	Packungsinhalt / box content (Stück / pieces)	
	USP	metric					
HR, HRS = 1/2-Kreis Rundkörper <i>HR, HRS = 1/2 circle, taper point</i>							
HR 10 ●		4-0	1.5	0,45	grün / green	8021	36
HR 17 ●		5-0	1	0,75	grün / green	8022	36
		4-0	1.5	0,75	grün / green	8023	36
		3-0	2	0,75	grün / green	8024	36
		2-0	3	0,75	grün / green	8025	36
2 x HR 17 ●		5-0	1	0,90	grün / green	8026	36
		4-0	1.5	0,90	grün / green	80231*	36
HR 22 ●		4-0	1.5	0,75	grün / green	80210	36
		3-0	2	0,75	grün / green	80211	36
		2-0	3	0,75	grün / green	80212	36
HR 27 ●		3-0	2	0,75	grün / green	80215	36
		2-0	3	0,75	grün / green	80216	36
		0	3.5	0,75	grün / green	80217	36
		1	4	0,75	grün / green	80218	36
2 x HR 27 ●		3-0	2	0,90	grün / green	80221	36
		2-0	3	0,90	grün / green	80222	36
HR 35 ●		2-0	3	0,75	grün / green	80224	36
		0	3.5	0,75	grün / green	80225	36
		1	4	0,75	grün / green	80226	36
HRS 35 ●		2-0	3	0,75	grün / green	8031	36
		0	3.5	0,75	grün / green	8032	36
HRT, HRTX = 1/2-Kreis schneidende Rundkörper <i>HRT, HRTX = 1/2 circle, taper cutting</i>							
HRT 18 ▼		4-0	1.5	0,45	grün / green	8069	36
		3-0	2	0,45	grün / green	80616	36
		5-0	1	0,75	grün / green	8061	36
		4-0	1.5	0,75	grün / green	8062	36
		3-0	2	0,75	grün / green	8063	36
HRTX 50 ▼		6	8	6 x 0,75	grün / green	M80619 (M)	12

*eventuell mit verlängerter Lieferzeit verbunden / *possibly associated with an extended delivery time*

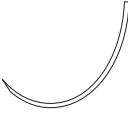
(M) = Multipack

POLYESTER

Sterile Nadel-Faden-Kombination / *needle suture combination, sterile*

Nadel / needle	Stärke / gauge USP	gauge metric	Länge / length (m)	Farbe / colour	Best.-Nr. / code no.	Packungsinhalt / box content (Stück / pieces)
ART = Asymptotische schneidende Rundkörper						
<i>ART = asymptotic, taper cutting</i>						
ART 13 ☉ 	4-0	1.5	0,45	grün / green	8281	12
ART 25 ☉ 	4-0	1.5	0,45	grün / green	8282	12
	3-0	2	0,45	grün / green	8283	12
HS = 1/2-Kreis außen schneidend						
<i>HS = 1/2 circle, reverse cutting</i>						
HS 18 ▼ 	5-0	1	0,45	grün / green	8111	36
	4-0	1.5	0,45	grün / green	8119	36
	3-0	2	0,45	grün / green	8112	36
	3-0	2	0,75	grün / green	8117	36
	2-0	3	0,75	grün / green	8118	36
HS 22 ▼ 	3-0	2	0,45	grün / green	8113	36
	3-0	2	0,75	grün / green	81110	36
HS 27 ▼ 	0	3.5	0,75	grün / green	8114	36
HS 35 ▼ 	1	4	0,75	grün / green	8115	36
HS 40 ▼ 	1	4	0,75	grün / green	8116	36

POLYESTER





Sterile Nadel-Faden-Kombination / *needle suture combination, sterile*

Nadel / needle	Stärke / gauge USP metric	Länge / length (m)	Farbe / colour	Best.-Nr. / code no.	Packungsinhalt / box content (Stück / pieces)	
DS, DS F = 3/8-Kreis außen schneidend DSM, DSM F = mit PREMIUM-Schliff <i>DS, DS F = 3/8 circle, reverse cutting</i> <i>DSM, DSM F = Premium cut</i>						
DSM 11 ▽ PREMIUM-Schliff / <i>PREMIUM cut</i>	6-0	0.7	0,45	grün / green	8151	36
DS 13 ▼	5-0	1	0,45	grün / green	8141	36
DSM 13 ▽ PREMIUM-Schliff / <i>PREMIUM cut</i>	5-0	1	0,45	grün / green	8156	36
	4-0	1.5	0,45	grün / green	8157	36
DS 16 ▼	6-0	0.7	0,45	grün / green	8147	36
	5-0	1	0,45	grün / green	8148	36
	4-0	1.5	0,45	grün / green	8149	36
DSM 16 ▽ PREMIUM-Schliff / <i>PREMIUM cut</i>	5-0	1	0,45	grün / green	81513	36
	4-0	1.5	0,45	grün / green	81514	36
DS 18 ▼	5-0	1	0,45	grün / green	81411	36
	4-0	1.5	0,45	grün / green	81412	36
	3-0	2	0,45	grün / green	81413	36
	3-0	2	4 x 0,45	grün / green	M81416 (M)	24
DS 18 F ▼	4-0	1.5	0,45	grün / green	81430	36
	4-0	1.5	0,45	weiß / white	81431	36
DSM 18 ▽ PREMIUM-Schliff / <i>PREMIUM cut</i>	4-0	1.5	0,45	grün / green	81515	36
	3-0	2	0,45	grün / green	81516	36
	2-0	3	0,45	grün / green	81517	36
DS 21 ▼	4-0	1.5	0,45	grün / green	81427	36
	3-0	2	0,45	grün / green	81428	36
	2-0	3	0,45	grün / green	81429	36
DSM 21 ▽ PREMIUM-Schliff / <i>PREMIUM cut</i>	4-0	1.5	0,45	grün / green	81520	36
	3-0	2	0,45	grün / green	81521	36
	2-0	3	0,45	grün / green	81522	36

(M) = Multipack







POLYESTER

Sterile Nadel-Faden-Kombination / *needle suture combination, sterile*

Nadel / needle	Stärke / gauge USP	metric	Länge / length (m)	Farbe / colour	Best.-Nr. / code no.	Packungsinhalt / box content (Stück / pieces)
DS 24 ▼ 	3-0	2	0,45	grün / green	81418	36
	2-0	3	0,45	grün / green	81419	36
	3-0	2	0,75	grün / green	81437	36
	2-0	3	0,75	grün / green	81434	36
	3-0	2	0,45	weiß / white	81420	36
DSM 24 ▽ PREMIUM-Schliff / <i>PREMIUM cut</i>	2-0	3	0,75	grün / green	81519	36
DS 27 ▼ 	0	3.5	0,75	grün / green	81439	36
	2-0	3	0,45	weiß / white	81421	36
DSM 27 ▽ PREMIUM-Schliff / <i>PREMIUM cut</i>	2-0	3	0,75	grün / green	81523	36
DS 30 ▼ 	0	3.5	0,45	grün / green	81435	36
	2-0	3	0,75	grün / green	81422	36
	0	3.5	0,75	grün / green	81423	36
	1	4	0,75	grün / green	81436	36
	3-0	2	0,45	weiß / white	81424	36
	2-0	3	0,45	weiß / white	81425	36
DS 40 ▼ 	1	4	0,75	grün / green	81438	36
DS 80 ▼ 	Ø 1,0 mm		1,50	weiß / white	81426	12

POLYESTER

Sterile Nadel-Faden-Kombination / *needle suture combination, sterile*

Nadel / needle	Stärke / gauge		Länge / length (m)	Farbe / colour	Best.-Nr. / code no.	Packungsinhalt / box content (Stück / pieces)
	USP	metric				
GS = Gerade schneidend <i>GS = straight, cutting</i>						
GS 60 	2-0	3	0,75	grün / green	8173	36
HSPM = 1/2-Kreis SPATULA, PREMIUM-Schliff <i>HSPM = 1/2 circle, spatulated, Premium cut</i>						
2 x HSPM 8   PREMIUM-Schliff / <i>PREMIUM cut</i>	5-0	1	0,45	weiß / white	8191	24
	4-0	1.5	0,45	weiß / white	8192	24
VSPM, VSPM F = 1/4-Kreis SPATULA, PREMIUM-Schliff <i>VSPM, VSPM F = 1/4 circle, spatulated, PREMIUM cut</i>						
2 x VSPM 8   PREMIUM-Schliff / <i>PREMIUM cut</i>	4-0	1.5	0,45	weiß / white	8217	24
2 x VSPM 8 F   PREMIUM-Schliff / <i>PREMIUM cut</i>	6-0	0.7	0,45	weiß / white	8211*	24
	5-0	1	0,45	weiß / white	8212	24
	4-0	1.5	0,45	weiß / white	8213	24

*eventuell mit verlängerter Lieferzeit verbunden / *possibly associated with an extended delivery time*

POLYESTER

Einzelfadenpackungen, steril in vorgeschrittenen Längen / *Sterile pre-cut suture, non-needled*

Stärke / <i>gauge</i> USP	metric	Länge / <i>length</i> (m)	Farbe / <i>colour</i>	Best.-Nr. / <i>code no.</i>	Packungsinhalt / <i>box content</i> (Stück / <i>pieces</i>)
4-0	1.5	5 x 0,35	grün / <i>green</i>	R353	24
3-0	2	5 x 0,35	grün / <i>green</i>	R453	24
2-0	3	5 x 0,35	grün / <i>green</i>	R553	24
0	3.5	5 x 0,35	grün / <i>green</i>	R653	24
1	4	5 x 0,35	grün / <i>green</i>	R753	24
3-0	2	5 x 0,35	weiß / <i>white</i>	WR453	24
2-0	3	5 x 0,35	weiß / <i>white</i>	WR553	24
5-0	1	3 x 0,50	grün / <i>green</i>	R235	24
4-0	1.5	3 x 0,50	grün / <i>green</i>	R335	24
3-0	2	3 x 0,50	grün / <i>green</i>	R435	24
2-0	3	3 x 0,50	grün / <i>green</i>	R535	24
0	3.5	3 x 0,50	grün / <i>green</i>	R635	24
1	4	3 x 0,50	grün / <i>green</i>	R735	24
2	5	3 x 0,50	grün / <i>green</i>	R835	24
3	6	3 x 0,50	grün / <i>green</i>	R935	24
3-0	2	3 x 0,50	weiß / <i>white</i>	WR435	24
2-0	3	3 x 0,50	weiß / <i>white</i>	WR535	24
0	3.5	3 x 0,50	weiß / <i>white</i>	WR635	24
2	5	3 x 0,50	weiß / <i>white</i>	WR835	24
5-0	1	5 x 0,50	grün / <i>green</i>	R255	24
4-0	1.5	5 x 0,50	grün / <i>green</i>	R355	24
3-0	2	5 x 0,50	grün / <i>green</i>	R455	24
2-0	3	5 x 0,50	grün / <i>green</i>	R555	24
0	3.5	5 x 0,50	grün / <i>green</i>	R655	24
1	4	5 x 0,50	grün / <i>green</i>	R755	24
2	5	5 x 0,50	grün / <i>green</i>	R855	24
3-0	2	5 x 0,50	weiß / <i>white</i>	WR455	24
2-0	3	5 x 0,50	weiß / <i>white</i>	WR555	24
0	3.5	5 x 0,50	weiß / <i>white</i>	WR655	24

POLYESTER

Einzelfadenpackungen, steril in vorgeschnittenen Längen / *Sterile pre-cut suture, non-needed*

Stärke / gauge USP	metric	Länge / length (m)	Farbe / colour	Best.-Nr. / code no.	Packungsinhalt / box content (Stück / pieces)
4-0	1.5	6 x 0,50	grün / green	SR355	24
3-0	2	6 x 0,50	grün / green	SR455	24
2-0	3	6 x 0,50	grün / green	SR555	24
0	3.5	6 x 0,50	grün / green	SR655	24
1	4	6 x 0,50	grün / green	SR755	24
2	5	6 x 0,50	grün / green	SR 855	24
3-0	2	10 x 0,50	grün / green	R4105	24
2-0	3	10 x 0,50	grün / green	R5105	24
0	3.5	10 x 0,50	grün / green	R6105	24
0	3.5	10 x 0,50	weiß / white	WR6105	24
3-0	2	12 x 0,50	grün / green	SR4105	24
2-0	3	12 x 0,50	grün / green	SR5105	24
0	3.5	12 x 0,50	grün / green	SR6105	24
1	4	12 x 0,50	grün / green	SR7105	24
3-0	2	2 x 0,75	grün / green	R420	24
2-0	3	2 x 0,75	grün / green	R520	24
0	3.5	2 x 0,75	grün / green	R620	24
1	4	2 x 0,75	grün / green	R720	24
2	5	2 x 0,75	grün / green	R820	24
3	6	2 x 0,75	grün / green	R920	24
3-0	2	2 x 0,75	weiß / white	WR420	24
2-0	3	2 x 0,75	weiß / white	WR520	24
0	3.5	2 x 0,75	weiß / white	WR620	24
1	4	2 x 0,75	weiß / white	WR720	24
3-0	2	5 x 0,75	grün / green	R450	24
2-0	3	5 x 0,75	grün / green	R550	24
0	3.5	5 x 0,75	grün / green	R650	24
1	4	5 x 0,75	grün / green	R750	24
2	5	5 x 0,75	grün / green	R850	24
0	3.5	1 x 1,20	grün / green	R612	24
1	4	1 x 1,40	grün / green	SR712	24
2	5	1 x 1,40	grün / green	SR812	24

SUPOLENE



- nicht-resorbierbarer Polyesterfaden
- extrem zugfest
- hydrophob
- alterungsbeständig
- sehr gewebefreundlich

- *non-absorbable suture*
- *high and permanent tensile strength*
- *hydrophobic*
- *non-ageing*
- *completely non-irritating*

SUPOLENE

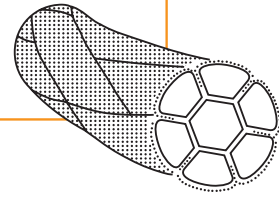

Eigenschaften:

- hohe Reißfestigkeit
- hervorragende Fadengleitfähigkeit, keine Sägewirkung
- sehr gleichmäßige und glatte Oberflächenbeschaffenheit
- sehr geringe Gewebereaktion
- geringe Kapillarität

SUPOLENE wird, ebenso wie POLYESTER, durch Polykondensation von Ethylenglykol und Terephthalsäure hergestellt.

Die Faserbildung erfolgt nach dem Trockenspinnverfahren. Anschließend wird der Faden präzisionsgeflochten, gefärbt, getempert und die Oberfläche durch Beschichtung des Fadens speziell veredelt. Durch diese Oberflächenbehandlung werden Kapillarität sowie Sägewirkung beim Gewebedurchzug und Knotenlauf auf ein Minimum reduziert.

SUPOLENE ist hydrophob, also ohne Wasserabsorptionseigenschaften. Das Material ist mit einem physiologisch unbedenklichen Farbstoff eingefärbt.

- ➔ Farbe: grün, weiß (ohne Farbstoff)
- ➔ Chemische Bezeichnung: Polyethylenterephthalat Polyesterfaser
- ➔ Fadenstärke: USP 6-0 -3 (0.7-6 metric)
- ➔ Konfektionsangebote:
 - Nadel-Faden-Kombinationen
 - in vorgeschrittenen Längen
- ➔ Sterilisation: Ethylenoxid

Properties:

- high tear resistance
- excellent tissue passage, no sawing effect
- very even and smooth surface properties
- very minimal tissue reaction
- minimal capillarity

Like POLYESTER, the production of SUPOLENE involves the polycondensation of ethylene glycol and terephthalic acid.













Fibres are formed using the dry spinning process. The suture then undergoes precision-braiding, dyeing and tempering and the surface is specially refined by coating. This surface treatment minimises capillarity and any sawing effect during tissue passage and knot rundown.

SUPOLENE is hydrophobic, i.e., it does not absorb water. The material is coloured with a physiologically harmless dye.

- ➔ Colour: green, white (no dye)
- ➔ Chemical name: polyethylene terephthalate polyester fibre
- ➔ Thread diameter: USP 6-0 -3 (0.7-6 metric)
- ➔ Types of packaging:
 - needle-thread-combinations
 - in precut lengths
- ➔ Sterilization method: ethylene oxide

SUPOLENE

Sterile Nadel-Faden-Kombination / *needle suture combination, sterile*









Nadel / needle	Stärke / gauge		Länge / length (m)	Farbe / colour	Best.-Nr. / code no.	Packungsinhalt / box content (Stück / pieces)
	USP	metric				
HR, HRX = 1/2-Kreis Rundkörper <i>HR, HRX = 1/2 circle, taper point</i>						
HR 12 ● 	5-0	1	0,75	grün / green	9021	36
	4-0	1.5	0,75	grün / green	9022	36
HR 12 A ● Abziehnadel / control release needle 	4-0	1.5	8 x 0,45	grün / green	A90232 (M)	12
2 x HR 15 ● 	5-0	1	0,75	grün / green	9024	36
HR 17 ● 	5-0	1	0,75	grün / green	9025	36
	4-0	1.5	0,75	grün / green	9026	36
	3-0	2	0,75	grün / green	9027	36
	2-0	3	0,75	grün / green	9028*	36
HR 17 A ● Abziehnadel / control release needle 	4-0	1.5	8 x 0,45	grün / green	A90238 (M)	12
2 x HR 17 ● 	4-0	1.5	0,90	grün / green	90210	36
	3-0	2	0,90	grün / green	90214	36
	2-0	3	0,90	grün / green	90234	36
HR 22 ● 	4-0	1.5	0,75	grün / green	90215	36
	3-0	2	0,75	grün / green	90216	36
	2-0	3	0,75	grün / green	90217	36
HR 22 A ● Abziehnadel / control release needle 	4-0	1.5	4 x 0,45	grün / green	A90233 (M)	12
2 x HRX 22 ● 	2	5	0,75	grün / green	9043	24
HR 27 ● 	4-0	1.5	0,75	grün / green	90233	36
	3-0	2	0,75	grün / green	90218	36
	2-0	3	0,75	grün / green	90219	36
	0	3.5	0,75	grün / green	90220	36
	1	4	0,75	grün / green	90221	36
	2-0	3	1,20	grün / green	90222	36
	0	3.5	1,20	grün / green	90223	36
	2-0	3	6 x 0,75	grün / green	M90222 (M)	12
	2 x HRX 27 ● 	2	5	0,75	grün / green	9041
	3	6	0,75	grün / green	9042	24
HR 30 ● 	2-0	3	0,75	grün / green	90227	36
	0	3.5	0,75	grün / green	90228	36
HR 35 ● 	0	3.5	0,75	grün / green	90230	36
	1	4	0,75	grün / green	90231	36

*eventuell mit verlängerter Lieferzeit verbunden / possibly associated with an extended delivery time

(M) = Multipack

SUPOLENE

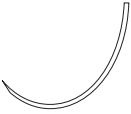





Sterile Nadel-Faden-Kombination / *needle suture combination, sterile*

Nadel / needle	Stärke / gauge		Länge / length (m)	Farbe / colour	Best.-Nr. / code no.	Packungsinhalt / box content (Stück / pieces)
	USP	metric				
HRT = 1/2-Kreis schneidende Rundkörper <i>HRT = 1/2 circle, taper cutting</i>						
HRT 18 ▼ 	5-0	1	0,45	grün / green	90630	36
	4-0	1.5	0,45	grün / green	90612	36
	5-0	1	0,75	grün / green	9061	36
	4-0	1.5	0,75	grün / green	9062	36
	3-0	2	0,75	grün / green	9063	36
	2-0	3	0,75	grün / green	9064	36
	0	3.5	0,75	grün / green	90652	36
2 x HRT 18 ▼ 	4-0	1.5	0,75	grün / green	9067	36
	3-0	2	0,75	grün / green	9068	36
	2-0	3	0,75	grün / green	9069	36
	0	3.5	0,75	grün / green	90610	36
HRT 25 ▼ 	3-0	2	0,75	grün / green	90616	36
	2-0	3	0,75	grün / green	90617	36
	0	3.5	0,75	grün / green	90618	36
HRT 35 ▼ 	2	5	0,75	grün / green	90655	24
HRT 45 ▼ 	0	3.5	0,75	grün / green	90620	24
	2	5	0,75	grün / green	90626	24
	2	5	4 x 0,75	grün / green	M90613 (M)	12
ART = Asymptotische schneidende Rundkörper <i>ART = asymptotic, taper cutting</i>						
ART 13 ▼ 	5-0	1	0,45	grün / green	9284	12
	4-0	1.5	0,45	grün / green	9281	12
ART 25 ▼ 	4-0	1.5	0,45	grün / green	9282	12
	3-0	2	0,45	grün / green	9283	12
DR = 3/8-Kreis Rundkörper <i>DR = 3/8 circle, taper point</i>						
DR 20 ● 	3-0	2	0,75	grün / green	90718	36

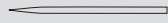
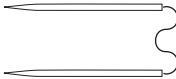
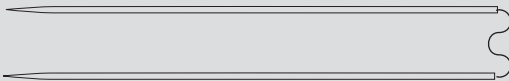
(M) = Multipack

SUPOLENE

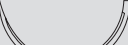
Sterile Nadel-Faden-Kombination / *needle suture combination, sterile*

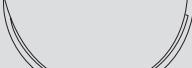
Nadel / needle	Stärke / gauge		Länge / length (m)	Farbe / colour	Best.-Nr. / code no.	Packungsinhalt / box content (Stück / pieces)
	USP	metric				
GR = Gerade Rundkörper <i>GR = straight, taper point</i>						
GR 20 ● 	4-0	1.5	0,45	grün / green	9096	36
	3-0	2	0,45	grün / green	9091	36
2 x GR 20 ● 	4-0	1.5	0,35	grün / green	9093	36
2 x GR 65 ● 	3	6	0,75	grün / green	9094	24
DRT = 3/8-Kreis schneidende Rundkörper (Diamond-Spitze) <i>DRT = 3/8 circle, taper cutting</i>						
DRT 12 ⊙ 	6-0	0.7	0,75	grün / green	9081	36
	5-0	1	0,75	grün / green	9082	36
DRT 18 ⊙ 	3-0	2	0,75	grün / green	9087	36
	2-0	3	0,75	grün / green	9088	36
HS = 1/2-Kreis außen schneidend <i>HS = 1/2 circle, reverse cutting</i>						
HS 18 ▼ 	4-0	1.5	0,45	grün / green	9118	36
	3-0	2	0,45	grün / green	9111	36
HS 22 ▼ 	3-0	2	0,75	grün / green	9112	36
	2-0	3	0,75	grün / green	9113	36
HS 27 ▼ 	0	3.5	0,75	grün / green	9115	36
HS 35 ▼ 	1	4	0,75	grün / green	9116	36
HS 40 ▼ 	1	4	0,75	grün / green	9117	36

SUPOLENE







Sterile Nadel-Faden-Kombination / *needle suture combination, sterile*

Nadel / needle	Stärke / gauge USP	metric	Länge / length (m)	Farbe / colour	Best.-Nr. / code no.	Packungsinhalt / box content (Stück / pieces)
DS = 3/8-Kreis außen schneidend, DSM = mit PREMIUM-Schliff <i>DS = 3/8 circle, reverse cutting, DSM = PREMIUM cut</i>						
DSM 11 ▽ PREMIUM-Schliff / <i>PREMIUM cut</i>	6-0	0.7	0,45	grün / <i>green</i>	9151	36
DS 13 ▼	4-0	1.5	0,45	grün / <i>green</i>	9142	36
DSM 13 ▽ PREMIUM-Schliff / <i>PREMIUM cut</i>	5-0	1	0,45	grün / <i>green</i>	9152	36
	4-0	1.5	0,45	grün / <i>green</i>	9153	36
DSM 16 ▽ PREMIUM-Schliff / <i>PREMIUM cut</i>	5-0	1	0,45	grün / <i>green</i>	9155	36
	4-0	1.5	0,45	grün / <i>green</i>	9156	36
DS 18 ▼	5-0	1	0,45	grün / <i>green</i>	9144	36
	4-0	1.5	0,45	grün / <i>green</i>	9145	36
	3-0	2	0,45	grün / <i>green</i>	9146	36
DS 18 F ▼	4-0	1.5	0,45	grün / <i>green</i>	91427	36
DSM 18 ▽ PREMIUM-Schliff / <i>PREMIUM cut</i>	4-0	1.5	0,45	grün / <i>green</i>	9157	36
	3-0	2	0,45	grün / <i>green</i>	9158	36
	2-0	3	0,45	grün / <i>green</i>	9159	36
	4-0	1.5	0,75	grün / <i>green</i>	91526	36
	3-0	2	4 x 0,45	grün / <i>green</i>	M91515 (M)	24
DS 21 ▼	4-0	1.5	0,45	grün / <i>green</i>	91423	36
	3-0	2	0,45	grün / <i>green</i>	91424	36
	2-0	3	0,45	grün / <i>green</i>	91425	36
DSM 21 ▽ PREMIUM-Schliff / <i>PREMIUM cut</i>	4-0	1.5	0,45	grün / <i>green</i>	91516	36
	3-0	2	0,45	grün / <i>green</i>	91517	36
	2-0	3	0,45	grün / <i>green</i>	91518	36
DS 24 ▼	4-0	1.5	0,45	grün / <i>green</i>	9147	36
	3-0	2	0,45	grün / <i>green</i>	9148	36
	2-0	3	0,45	grün / <i>green</i>	9149	36
	3-0	2	0,75	grün / <i>green</i>	91410	36
	0	3.5	0,75	grün / <i>green</i>	91433	36
DSM 24 ▽ PREMIUM-Schliff / <i>PREMIUM cut</i>	3-0	2	0,75	grün / <i>green</i>	91513	36
	2-0	3	0,75	grün / <i>green</i>	91514	36
DS 27 ▼	2-0	3	0,45	grün / <i>green</i>	91411	36
	2-0	3	0,75	grün / <i>green</i>	91426	36
DSM 27 ▽ PREMIUM-Schliff / <i>PREMIUM cut</i>	2-0	3	0,45	grün / <i>green</i>	91520	36
	2-0	3	0,75	grün / <i>green</i>	91519	36

(M) = Multipack

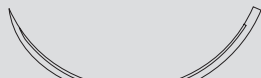
SUPOLENE

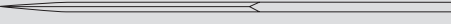
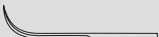
Sterile Nadel-Faden-Kombination / *needle suture combination, sterile*

Nadel / needle	Stärke / gauge		Länge / length (m)	Farbe / colour	Best.-Nr. / code no.	Packungsinhalt / box content (Stück / pieces)
	USP	metric				
DS 30 ▼ 	2-0	3	0,75	grün / green	91412	36
	0	3.5	0,75	grün / green	91413	36
	1	4	0,75	grün / green	91428	36
DSM 30 ▽ 	2-0	3	0,75	grün / green	91521	36
	0	3.5	0,75	grün / green	91522	36
PREMIUM-Schliff / <i>PREMIUM cut</i>						
DS 40 ▼ 	2-0	3	0,75	grün / green	91435	36
	0	3.5	0,75	grün / green	91414	36
DS 50 ▼ 	1	4	0,75	grün / green	91434	36
GS = Gerade schneidend <i>GS = straight, cutting</i>						
GS 60 ▼ 	0	3.5	0,45	grün / green	9178	36
	2-0	3	0,75	grün / green	9174	36
	0	3.5	0,75	grün / green	9179	36
KS = 1/2-gebogene außen schneidend <i>KS = 1/2 curved, reverse cutting</i>						
KS 20 ▼ 	3-0	2	0,45	grün / green	9181	36
HSPM = 1/2-Kreis SPATULA (PREMIUM-Schliff) <i>HSPM = 1/2 circle, spatulated (PREMIUM cut)</i>						
2 x HSPM 8 ▽ 	5-0	0.7	0,45	weiß / white	9192	24
	4-0	1.5	0,45	weiß / white	9191	24
PREMIUM-Schliff / <i>PREMIUM cut</i>						
VSPM F = 1/4-Kreis SPATULA (PREMIUM-Schliff) <i>VSPM F = 1/4 circle, spatulated (PREMIUM cut)</i>						
2 x VSPM 8 F ▽ 	6-0	0.7	0,45	weiß / white	9211	24
	5-0	1	0,45	weiß / white	9212	24
PREMIUM-Schliff / <i>PREMIUM cut</i>						

SUPOLENE

Einzelfadenpackungen, steril in vorgeschnittenen Längen / *Sterile pre-cut suture, non-needed*

Stärke / gauge USP metric		Länge / length (m)	Farbe / colour	Best.-Nr. / code no.	Packungsinhalt / box content (Stück / pieces)
3-0	2	5 x 0,35	grün / green	W453	24
2-0	3	5 x 0,35	grün / green	W553	24
0	3.5	5 x 0,35	grün / green	W653	24
4-0	1.5	3 x 0,50	grün / green	W335	24
3-0	2	3 x 0,50	grün / green	W435	24
2-0	3	3 x 0,50	grün / green	W535	24
0	3.5	3 x 0,50	grün / green	W635	24
1	4	3 x 0,50	grün / green	W735	24
2	5	3 x 0,50	grün / green	W835	24
4-0	1.5	5 x 0,50	grün / green	W355	24
3-0	2	5 x 0,50	grün / green	W455	24
2-0	3	5 x 0,50	grün / green	W555	24
0	3.5	5 x 0,50	grün / green	W655	24
1	4	5 x 0,50	grün / green	W755	24
2	5	5 x 0,50	grün / green	W855	24
4-0	1.5	6 x 0,50	grün / green	SW355	24
3-0	2	6 x 0,50	grün / green	SW455	24
2-0	3	6 x 0,50	grün / green	SW555	24
0	3.5	6 x 0,50	grün / green	SW655	24
1	4	6 x 0,50	grün / green	SW755	24
2	5	6 x 0,50	grün / green	SW855	24
4-0	1.5	10 x 0,50	grün / green	W3105	24
3-0	2	10 x 0,50	grün / green	W4105	24
2-0	3	10 x 0,50	grün / green	W5105	24
2-0	3	12 x 0,50	grün / green	SW5105	24
0	3.5	12 x 0,50	grün / green	SW6105	24
1	4	12 x 0,50	grün / green	SW7105	24
3-0	2	17 x 0,50	grün / green	W4175	24

SUPOLENE

Einzelfadenpackungen, steril in vorgeschnittenen Längen / *Sterile pre-cut suture, non-needed*

Stärke / USP	gauge metric	Länge / <i>length</i> (m)	Farbe / <i>colour</i>	Best.-Nr. / code no.	Packungsinhalt / <i>box content</i> (Stück / <i>pieces</i>)
2-0	3	2 x 0,75	grün / <i>green</i>	W520	24
0	3.5	2 x 0,75	grün / <i>green</i>	W620	24
1	4	2 x 0,75	grün / <i>green</i>	W720	24
2	5	2 x 0,75	grün / <i>green</i>	W820	24
3	6	2 x 0,75	grün / <i>green</i>	W920	24
1	4	5 x 0,75	grün / <i>green</i>	W750	24
2	5	5 x 0,75	grün / <i>green</i>	W850	24
3	6	5 x 0,75	grün / <i>green</i>	W950	24

NYLON



- nicht-resorbierbares Material
- überdurchschnittlich geschmeidig und weich
- sehr gute Knüpfeigenschaften
- hervorragender Gewebedurchzug
- keine Kapillarität
- geringe Gewebereaktion

- *non-absorbable suture*
- *very soft and supple*
- *perfect handling and knotting*
- *easy passage through tissue*
- *no capillarity*
- *minimal tissue reactions*

NYLON

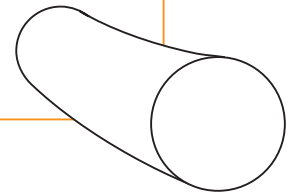

Eigenschaften:

- überdurchschnittlich weich und geschmeidig
- sehr gute Handhabungs- und Knüpf Eigenschaften
- keine Kapillarität
- hervorragendes Gewebedurchzugsverhalten

NYLON ist ein aus Polyamid 6-6.6 extrudierter (in formbarem Zustand durch Düsen gepresster und gereckter) monofiler Faden. Aufgrund der hohen Reißfestigkeit, selbst bei geringstem Fadendurchmesser, ist Nylon speziell für feinste Nähte in der Mikrochirurgie geeignet. Polyamide können bis zu 10% Wasser binden.

Das Material ist mit einem physiologisch unbedenklichen Farbstoff eingefärbt.

- Farbe: weiß (ohne Farbstoff), schwarz
- Chemische Bezeichnung: Polyamid 6-6.6
- Fadenstärke: USP 10-0 -2 (0.2-5 metric)
- Konfektionsangebote:
 - Nadel-Faden-Kombinationen
- Sterilisation: Ethylenoxid

Properties:

- above-average softness and suppleness
- superior handling and knotting properties
- no capillarity
- excellent tissue passage

NYLON is a monofilament extruded thread (pressed and drawn through dies in a malleable condition) made from polyamide 6-6.6.



Because of its high tensile strength, even when the fibre diameter is very fine, NYLON is particularly suitable for very fine suturing in microsurgery. Polyamides can bind up to 10% water.

The material is coloured with a physiologically safe dye.

- Colour: white (no dye), black
- Chemical name: polyamide 6-6.6
- Thread diameter: USP 10-0 -2 (0.2-5 metric)
- Types of packaging:
 - needle-thread-combinations
- Sterilization method: ethylene oxide

NYLON

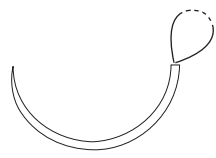
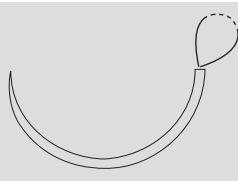
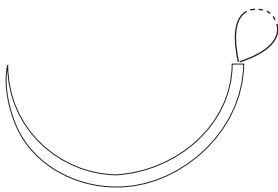
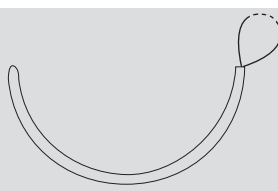
Sterile Nadel-Faden-Kombination / *needle suture combination, sterile*

Nadel / needle	Stärke / gauge		Länge / length (m)	Farbe / colour	Best.-Nr. / code no.	Packungsinhalt / box content (Stück / pieces)
	USP	metric				
HR F, HRS, HRX = 1/2-Kreis Rundkörper <i>HR F, HRS, HRX = 1/2 circle, taper point</i>						
2 x HR 6 F ● 	10-0	0.2	0,10	schwarz / black	5021N ¹⁾	24
HRS 35 ● 	1	4	1,50	schwarz / black	5035	24
HRS 40 ● 	0	3.5	1,50	schwarz / black	5033	24
HRX 50 ● 	0	3.5	1,50	schwarz / black	5042	24
	1	4	1,50	schwarz / black	5041	24
HRN = 1/2-Kreis Rundkörper, stumpf <i>HRN = 1/2 circle, blunt taper point</i>						
HRN 50 ○ 	1	4	1,50	schwarz / black	5050	24
HRT = 1/2-Kreis schneidende Rundkörper <i>HRT = 1/2 circle, taper cutting</i>						
HRT 18 ⊖ 	4-0	1.5	0,75	schwarz / black	5061	36













NYLON

Sterile Nadel-Faden-Kombination / *needle suture combination, sterile*

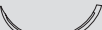
Nadel / needle	Stärke / gauge		Länge / length (m)	Farbe / colour	Best.-Nr. / code no.	Packungsinhalt / box content (Stück / pieces)
	USP	metric				
DR, DR F = 3/8-Kreis Rundkörper <i>DR, DR F = 3/8 circle, taper point</i>						
DR 4 ●	10-0	0.2	0,10	schwarz / black	50714N ¹⁾	24
DR 5 ●	8-0	0.4	0,15	schwarz / black	50715N ¹⁾	24
DR 5 F ●	10-0	0.2	0,15	schwarz / black	5071N ¹⁾	24
	9-0	0.3	0,15	schwarz / black	5072N ¹⁾	24
2 x DR 5 F ●	10-0	0.2	0,15	schwarz / black	5073N ¹⁾	24
DR 6 ●	10-0	0.2	0,15	schwarz / black	5074N ¹⁾	24
	9-0	0.3	0,15	schwarz / black	5075N ¹⁾	24
	8-0	0.4	0,15	schwarz / black	5076N ¹⁾	24
2 x DR 6 ●	9-0	0.3	0,15	schwarz / black	5077N ¹⁾	24
DR 10 F ●	7-0	0.5	0,45	schwarz / black	5079	36
DR 12 ●	5-0	1	0,75	schwarz / black	50712	36
DR 12 F ●	6-0	0.7	0,75	schwarz / black	50711	36
HS, HSM = 1/2-Kreis außen schneidend, mit PREMIUM-Schliff <i>HS, HSM = 1/2 circle, reverse cutting, PREMIUM cut</i>						
2 x HSM 8 ▽ PREMIUM-Schliff / PREMIUM cut	9-0	0.3	0,45	schwarz / black	5121N ¹⁾	24
HS 12 ▼	5-0	1	0,45	schwarz / black	5111	36
HSM 17 ▽ PREMIUM-Schliff / PREMIUM cut	4-0	1.5	0,45	schwarz / black	5126	36

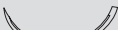

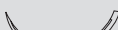

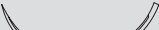







NYLON

Sterile Nadel-Faden-Kombination / *needle suture combination, sterile*

Nadel / needle	Stärke / gauge		Länge / length (m)	Farbe / colour	Best.-Nr. / code no.	Packungsinhalt / box content (Stück / pieces)
	USP	metric				
DS, DS F = 3/8-Kreis außen schneidend DSM, DSM F = mit PREMIUM-Schliff <i>DS, DS F = 3/8 circle, reverse cutting</i> <i>DS, DSM F = PREMIUM cut</i>						
DSM 6  ▽ PREMIUM-Schliff / <i>PREMIUM cut</i>	10-0	0.2	0,30	schwarz / <i>black</i>	5152N ¹⁾	24
DSM 7  ▽ PREMIUM-Schliff / <i>PREMIUM cut</i>	7-0	0.5	0,45	schwarz / <i>black</i>	5155	36
DSM 11  ▽ PREMIUM-Schliff / <i>PREMIUM cut</i>	7-0	0.5	0,45	schwarz / <i>black</i>	5156	36
	6-0	0.7	0,45	schwarz / <i>black</i>	5157	36
DS 13  ▼	6-0	0.7	0,45	schwarz / <i>black</i>	5142	36
	5-0	1	0,45	schwarz / <i>black</i>	5143	36
	4-0	1.5	0,45	schwarz / <i>black</i>	5144	36
DSM 13  ▽ PREMIUM-Schliff / <i>PREMIUM cut</i>	6-0	0.7	0,45	schwarz / <i>black</i>	51540	36
	5-0	1	0,45	schwarz / <i>black</i>	51513	36
	4-0	1.5	0,45	schwarz / <i>black</i>	51514	36
DS 16  ▼	6-0	0.7	0,45	schwarz / <i>black</i>	5145	36
	5-0	1	0,45	schwarz / <i>black</i>	5146	36
DSM 16  ▽ PREMIUM-Schliff / <i>PREMIUM cut</i>	4-0	1.5	0,45	schwarz / <i>black</i>	51517	36
DSM 16 F  ▽ PREMIUM-Schliff / <i>PREMIUM cut</i>	5-0	1	0,45	schwarz / <i>black</i>	51541	36
DS 18  ▼	5-0	1	0,45	schwarz / <i>black</i>	5147	36
	4-0	1.5	0,45	schwarz / <i>black</i>	5148	36
	3-0	2	0,45	schwarz / <i>black</i>	5149	36
	2-0	3	0,45	schwarz / <i>black</i>	51423	36
	5-0	1	0,75	schwarz / <i>black</i>	51444	36
	4-0	1.5	0,75	schwarz / <i>black</i>	51445	36
	3-0	2	0,75	schwarz / <i>black</i>	51410	36
	4-0	1.5	0,45	weiß / <i>white</i>	51414	36
DS 18 F  ▼	4-0	1.5	0,45	schwarz / <i>black</i>	51442	36
DSM 18  ▽ PREMIUM-Schliff / <i>PREMIUM cut</i>	5-0	1	0,45	schwarz / <i>black</i>	51518	36
	4-0	1.5	0,45	schwarz / <i>black</i>	51519	36
	3-0	2	0,45	schwarz / <i>black</i>	51520	36
	2-0	3	0,45	schwarz / <i>black</i>	51521	36
	3-0	2	0,75	schwarz / <i>black</i>	51522	36
DS 21  ▼	4-0	1.5	0,45	schwarz / <i>black</i>	51439	36
	3-0	2	0,45	schwarz / <i>black</i>	51440	36
DS 24  ▼	3-0	2	0,45	schwarz / <i>black</i>	51415	36
	3-0	2	0,75	schwarz / <i>black</i>	51416	36

NYLON

Sterile Nadel-Faden-Kombination / *needle suture combination, sterile*

Nadel / needle	Stärke / gauge		Länge / length (m)	Farbe / colour	Best.-Nr. / code no.	Packungsinhalt / box content (Stück / pieces)
	USP	metric				
DSM 24  ▽ PREMIUM-Schliff / <i>PREMIUM cut</i>	3-0	2	0,45	schwarz / <i>black</i>	51523	36
	2-0	3	0,45	schwarz / <i>black</i>	51524	36
	3-0	2	0,75	schwarz / <i>black</i>	51535	36
	2-0	3	0,75	schwarz / <i>black</i>	51536	36
DS 27 	2-0	3	0,45	schwarz / <i>black</i>	51419	36
DS 30 	0	3.5	0,45	schwarz / <i>black</i>	51421	36
	2-0	3	0,75	schwarz / <i>black</i>	51454	36
HSPM, HSPM F = 1/2-Kreis SPATULA, PREMIUM-Schliff <i>HSPM, HSPM F= 1/2 circle, spatulated, PREMIUM cut</i>						
HSPM 6 F  ▽ PREMIUM-Schliff / <i>PREMIUM cut</i>	10-0	0.2	0,15	schwarz / <i>black</i>	51914N ¹⁾	24
	9-0	0.3	0,15	schwarz / <i>black</i>	51913N ¹⁾	24
2x HSPM 6 F  ▽ PREMIUM-Schliff / <i>PREMIUM cut</i>	10-0	0.2	0,30	schwarz / <i>black</i>	5198N ¹⁾	24
	9-0	0.3	0,30	schwarz / <i>black</i>	5199N ¹⁾	24
2 x HSPM 7  ▽ PREMIUM-Schliff / <i>PREMIUM cut</i>	10-0	0.2	0,30	schwarz / <i>black</i>	5193N ¹⁾	24
	9-0	0.3	0,30	schwarz / <i>black</i>	5194N ¹⁾	24
DSPM = 3/8-Kreis SPATULA PREMIUM-Schliff <i>DSPM= 3/8 circle, spatulated, PREMIUM cut</i>						
DSPM 4  ▽ PREMIUM-Schliff / <i>PREMIUM cut</i>	10-0	0.2	0,10	schwarz / <i>black</i>	52014N ¹⁾	24
DSPM 5  ▽ PREMIUM-Schliff / <i>PREMIUM cut</i>	10-0	0.2	0,30	schwarz / <i>black</i>	5201N ¹⁾	24
2 x DSPM 5  ▽ PREMIUM-Schliff / <i>PREMIUM cut</i>	10-0	0.2	0,30	schwarz / <i>black</i>	5202N ¹⁾	24
DSPM 6  ▽ PREMIUM-Schliff / <i>PREMIUM cut</i>	10-0	0.2	0,15	schwarz / <i>black</i>	5206N ¹⁾	24
	9-0	0.3	0,15	schwarz / <i>black</i>	52011N ¹⁾	24
	10-0	0.2	0,30	schwarz / <i>black</i>	52015N ¹⁾	24
2 x DSPM 6  ▽ PREMIUM-Schliff / <i>PREMIUM cut</i>	10-0	0.2	0,30	schwarz / <i>black</i>	5208N ¹⁾	24
2 x DSPM 7  ▽ PREMIUM-Schliff / <i>PREMIUM cut</i>	10-0	0.2	0,30	schwarz / <i>black</i>	5203N ¹⁾	24
	9-0	0.3	0,30	schwarz / <i>black</i>	5204N ¹⁾	24

¹⁾ Produkt hergestellt durch / *product manufactured by:*



- nicht-resorbierbares Material
 - überdurchschnittlich geschmeidig und weich
 - sehr gute Knüpfeigenschaften
 - hervorragender Gewebedurchzug
 - keine Kapillarität
 - geringe Gewebereaktion
- *non-absorbable suture*
 - *softer and more supple than average*
 - *perfect handling and knotting*
 - *easy passage through tissue*
 - *no capillarity*
 - *non-irritating*

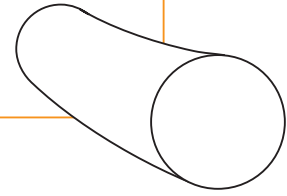

Eigenschaften:

- überdurchschnittlich weich und geschmeidig
- sehr gute Handhabungs- und Knüpfeigenschaften
- keine Kapillarität
- hervorragendes Gewebedurchzugsverhalten

RESOLON® ist zunächst, wie NYLON, ein monofiler Polyamid 6-6.6 Faden, der jedoch im Herstellungsprozess einer speziellen Behandlung unterzogen wird.

RESOLON® ist auch im trockenen sterilen Zustand überdurchschnittlich weich und geschmeidig. Dadurch ergeben sich für einen monofilen Faden hervorragende Handhabungs- und Knüpfeigenschaften bei optimaler Knotenreißkraft.

- Farbe: blau
- Chemische Bezeichnung: Polyamid 6-6.6
- Fadenstärke: USP 7-0 -1 (0.5-4 metric)
- Konfektionsangebote:
 - Nadel-Faden-Kombinationen
 - in vorgeschrittenen Längen
- Sterilisation: Ethylenoxid

Properties:

- above-average softness and suppleness
- superior handling and knotting properties
- no capillarity
- excellent tissue passage

RESOLON® is initially a monofilament polyamide 6-6.6 suture, like NYLON. However, it undergoes special treatment during the manufacturing process.











RESOLON® is exceptionally soft and supple even when dry and sterile.

As a result, it has excellent handling and knotting properties for a monofilament suture, while ensuring maximum knot tear resistance.

- Colour: blue
- Chemical name: polyamide 6-6.6
- Thread diameter: USP 7-0 -1 (0.5-4 metric)
- Types of packaging:
 - needle-thread-combinations
 - pre-cut lengths
- Sterilization method: ethylene oxide









RESOLON®

Sterile Nadel-Faden-Kombination / *needle suture combination, sterile*

Nadel / needle	Stärke / gauge		Länge / length (m)	Farbe / colour	Best.-Nr. / code no.	Packungsinhalt / box content (Stück / pieces)	
	USP	metric					
HRT = 1/2-Kreis schneidende Rundkörper							
<i>HRT = 1/2 circle, taper cutting</i>							
HRT 18 ☉		5-0	1	0,45	blau / blue	88062	36
		4-0	1.5	0,45	blau / blue	88061	36
HS = 1/2-Kreis außen schneidend							
HSM = mit PREMIUM-Schliff							
<i>HS = 1/2 circle, reverse cutting, HSM = PREMIUM cut</i>							
HS 12 ▼		5-0	1	0,45	blau / blue	88111	36
HSM 17 ▽ PREMIUM-Schliff / PREMIUM cut		4-0	1.5	0,45	blau / blue	88121	36
HS 18 ▼		5-0	1	0,45	blau / blue	88112	36
		4-0	1.5	0,45	blau / blue	88113	36
		5-0	1	0,75	blau / blue	88116	36
		4-0	1.5	0,75	blau / blue	88115	36
HS 22 ▼		3-0	2	0,45	blau / blue	88114	36
DS = 3/8-Kreis außen schneidend							
DSM, DSM F = mit PREMIUM-Schliff							
<i>DS = 3/8 circle, reverse cutting</i>							
<i>DSM, DSM F = PREMIUM cut</i>							
DSM 7 ▽ PREMIUM-Schliff / PREMIUM cut		7-0	0.5	0,45	blau / blue	881543	36
DSM 11 ▽ PREMIUM-Schliff / PREMIUM cut		6-0	0.7	0,45	blau / blue	88151	36
		5-0	1	0,45	blau / blue	88152	36
DSM 11 F ▽ PREMIUM-Schliff / PREMIUM cut		7-0	0.5	0,45	blau / blue	881528	36
		6-0	0.7	0,45	blau / blue	881549	36
DS 13 ▼		6-0	0.7	0,45	blau / blue	881430	36
		5-0	1	0,45	blau / blue	881431	36
		4-0	1.5	0,45	blau / blue	881432	36
DSM 13 ▽ PREMIUM-Schliff / PREMIUM cut		6-0	0.7	0,45	blau / blue	88153	36
		5-0	1	0,45	blau / blue	88154	36
		4-0	1.5	0,45	blau / blue	881523	36
		6-0	0.7	0,75	blau / blue	881553	36
		5-0	1	0,75	blau / blue	881554	36

RESOLON®







Sterile Nadel-Faden-Kombination / *needle suture combination, sterile*

Nadel / needle	Stärke / gauge USP	metric	Länge / length (m)	Farbe / colour	Best.-Nr. / code no.	Packungsinhalt / box content (Stück / pieces)
DS 16 ▼ 	6-0	0,7	0,45	blau / blue	881440	36
	5-0	1	0,45	blau / blue	88141	36
	4-0	1,5	0,45	blau / blue	88142	36
	3-0	2	0,45	blau / blue	881433	36
	5-0	1	0,75	blau / blue	881451	36
	4-0	1,5	0,75	blau / blue	881452	36
DSM 16 ▽ PREMIUM-Schliff / <i>PREMIUM cut</i> 	6-0	0,7	0,45	blau / blue	881529	36
	5-0	1	0,45	blau / blue	88155	36
	4-0	1,5	0,45	blau / blue	88156	36
	3-0	2	0,45	blau / blue	881548	36
	5-0	1,0	0,75	blau / blue	881530	36
	4-0	1,5	0,75	blau / blue	881551	36
	3-0	2	0,75	blau / blue	881552	36
DSM 16 F ▽ PREMIUM-Schliff / <i>PREMIUM cut</i> 	5-0	1	0,45	blau / blue	881550	36
DS 18 ▼ 	5-0	1	0,45	blau / blue	88143	36
	4-0	1,5	0,45	blau / blue	88144	36
	3-0	2	0,45	blau / blue	88146	36
	2-0	3	0,45	blau / blue	881454	36
	5-0	1	0,75	blau / blue	881450	36
	4-0	1,5	0,75	blau / blue	88145	36
	3-0	2	0,75	blau / blue	88147	36
	2-0	3	0,75	blau / blue	88148	36
	4-0	1,5	4 x 0,45	blau / blue	M881421 (M)	24
	DS 18 F ▼ 	4-0	1,5	0,45	blau / blue	881441
4-0	1,5	0,75	blau / blue	881442	36	
DSM 18 ▽ PREMIUM-Schliff / <i>PREMIUM cut</i> 	5-0	1	0,45	blau / blue	88157	36
	4-0	1,5	0,45	blau / blue	88158	36
	3-0	2	0,45	blau / blue	881510	36
	2-0	3	0,45	blau / blue	881531	36
	5-0	1	0,75	blau / blue	881555	36
	4-0	1,5	0,75	blau / blue	88159	36
	3-0	2	0,75	blau / blue	881511	36
	2-0	3	0,75	blau / blue	881512	36
	DSM 18 F ▽ PREMIUM-Schliff / <i>PREMIUM cut</i> 	4-0	1,5	0,45	blau / blue	881541
4-0	1,5	0,75	blau / blue	881542	36	
DS 21 ▼ 	4-0	1,5	0,45	blau / blue	88149	36
	3-0	2	0,45	blau / blue	881411	36
	4-0	1,5	0,75	blau / blue	881410	36
	3-0	2	0,75	blau / blue	881412	36
	2-0	3	0,75	blau / blue	881413	36

(M) = Multipack



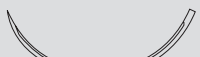

RESOLON®

Sterile Nadel-Faden-Kombination / *needle suture combination, sterile*

Nadel / needle	Stärke / gauge USP	gauge metric	Länge / length (m)	Farbe / colour	Best.-Nr. / code no.	Packungsinhalt / box content (Stück / pieces)
DSM 21  PREMIUM-Schliff / <i>PREMIUM cut</i>	4-0	1.5	0,45	blau / blue	881513	36
	3-0	2	0,45	blau / blue	881515	36
	4-0	1.5	0,75	blau / blue	881514	36
	3-0	2	0,75	blau / blue	881516	36
	2-0	3	0,75	blau / blue	881517	36
DS 24  	5-0	1	0,45	blau / blue	881458	36
	4-0	1.5	0,45	blau / blue	881424	36
	3-0	2	0,45	blau / blue	881414	36
	2-0	3	0,45	blau / blue	881425	36
	4-0	1.5	0,75	blau / blue	881457	36
	3-0	2	0,75	blau / blue	881415	36
	2-0	3	0,75	blau / blue	881416	36
DSM 24  PREMIUM-Schliff / <i>PREMIUM cut</i>	4-0	1.5	0,45	blau / blue	881544	36
	3-0	2	0,45	blau / blue	881518	36
	2-0	3	0,45	blau / blue	881524	36
	4-0	1.5	0,75	blau / blue	881545	36
	3-0	2	0,75	blau / blue	881519	36
	2-0	3	0,75	blau / blue	881520	36
DS 27  	3-0	2	0,45	blau / blue	881453	36
	2-0	3	0,45	blau / blue	881423	36
	0	3.5	0,45	blau / blue	881456	36
	3-0	2	0,75	blau / blue	881417	36
	2-0	3	0,75	blau / blue	881418	36
	0	3.5	0,75	blau / blue	881459	36
	2-0	3	0,75	blau / blue	881418	36
DSM 27  PREMIUM-Schliff / <i>PREMIUM cut</i>	2-0	3	0,45	blau / blue	881525	36
	2-0	3	0,75	blau / blue	881526	36
DS 30  	4-0	1.5	0,45	blau / blue	881434	36
	3-0	2	0,45	blau / blue	881426	36
	2-0	3	0,45	blau / blue	881428	36
	0	3.5	0,45	blau / blue	881429	36
	4-0	1.5	0,75	blau / blue	881435	36
	3-0	2	0,75	blau / blue	881427	36
	2-0	3	0,75	blau / blue	881419	36
	0	3.5	0,75	blau / blue	881420	36
	2-0	3	0,75	blau / blue	881419	36
DSM 30  PREMIUM-Schliff / <i>PREMIUM cut</i>	3-0	2	0,45	blau / blue	881532	36
	2-0	3	0,45	blau / blue	881534	36
	0	3.5	0,45	blau / blue	881536	36
	3-0	2	0,75	blau / blue	881533	36
	2-0	3	0,75	blau / blue	881535	36
	0	3.5	0,75	blau / blue	881537	36

RESOLON®

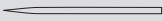
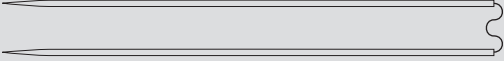
Sterile Nadel-Faden-Kombination / *needle suture combination, sterile*

Nadel / needle	Stärke / gauge		Länge / length (m)	Farbe / colour	Best.-Nr. / code no.	Packungsinhalt / box content (Stück / pieces)
	USP	metric				
DS 40 	2-0	3	0,45	blau / blue	881436	36
	0	3.5	0,45	blau / blue	881438	36
	3-0	2	0,75	blau / blue	881443	36
	2-0	3	0,75	blau / blue	881437	36
	0	3.5	0,75	blau / blue	881439	36
	2-0	3	0,90	blau / blue	881455	36
DSM 40  PREMIUM-Schliff / <i>PREMIUM cut</i>	2-0	3	0,75	blau / blue	881538	36
	0	3.5	0,75	blau / blue	881540	36
GR = Gerade Rundkörper <i>GR = straight, taper point</i>						
GR 20 	4-0	1.5	0,45	blau / blue	88093	36
GRW = Gerade Rundkörper, biegsame Nadel <i>GRW = straight, taper point, flexible needle</i>						
2 x GRW 65  ● <i>Biegsame Nadel / Flexible needle</i>	2-0	3	0,75	blau / blue	88091	36
	0	3.5	0,75	blau / blue	88092	36
GS = Gerade schneidend <i>GS = Straight cutting</i>						
GS 60 	3-0	2	0,75	blau / blue	88171	36
	2-0	3	0,75	blau / blue	88172	36

RESOLON®

Einzelfadenpackungen, steril in vorgeschnittenen Längen / *Sterile pre-cut suture, non-needed*

Stärke / <i>gauge</i> USP	<i>metric</i>	Länge / <i>length</i> (m)	Farbe / <i>colour</i>	Best.-Nr. / <i>code no.</i>	Packungsinhalt / <i>box content</i> (Stück / <i>pieces</i>)
4-0	1.5	3 x 0,50	blau / <i>blue</i>	X335N	24
3-0	2	3 x 0,50	blau / <i>blue</i>	X435N	24
2-0	3	3 x 0,50	blau / <i>blue</i>	X535N	24
0	3.5	3 x 0,50	blau / <i>blue</i>	X635N*	24
3-0	2	10 x 0,50	blau/blue	X4105N*	24

*eventuell mit verlängerter Lieferzeit verbunden / *possibly associated with an extended delivery time*



- nicht-resorbierbarer Polyamid-Faden
- sehr geschmeidig
- zugfest
- geringe Gewebereaktion
- gute Knoteneigenschaften

- *non-absorbable polyamide-suture*
- *very soft*
- *high tensile strength*
- *less tissue reaction*
- *good knotting properties*

SUPRAMID

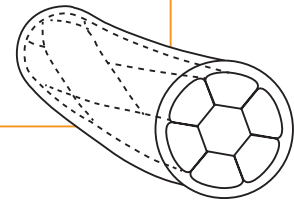

Eigenschaften:

- überdurchschnittlich weich und geschmeidig
- sehr gute Handhabungs- und Knüpfeigenschaften
- keine Kapillarität
- hervorragendes Gewebedurchzugsverhalten

SUPRAMID ist als monofiles, nicht-resorbierbares, chirurgisches Nahtmaterial aus einem Copolymerisat aus Polyamid 6 und Polyamid 6.6 erhältlich. In stärkeren Durchmessern wird es als pseudomonofiles

nicht-resorbierbares, chirurgisches Nahtmaterial aus Polyamid 6.6, einem Polymer von Hexamethylen-diamin und Adipinsäure, mit einer Beschichtung aus Polyamid 6, einem ϵ -Caprolactam-Polymer, angeboten.

Besonderheit

Trotz seiner synthetischen Herkunft, bedingt durch die peptidartige Struktur, unterliegt SUPRAMID nach längerem Verbleib im Gewebe der allmählichen Degradation und ist daher mit wenigen Ausnahmen nur für Hautnähte oder Gewebe, die keine permanenten Wundunterstützungen benötigen, geeignet.

Das Material ist mit einem physiologisch unbedenklichen Farbstoff eingefärbt.

- Farbe: weiß (ohne Farbstoff) oder schwarz
- Chemische Bezeichnung: monofil: Polyamid 6-6.6 pseudomonofil: Polyamid 6.6 und Polyamid 6
- Fadenstärke: USP 6-0 -2 (0.7-5 metric)
- Konfektionsangebote:
 - Nadel-Faden-Kombinationen
 - in vorgeschrittenen Längen
- Sterilisation: Ethylenoxid

Properties:

- above-average softness and suppleness
- superior handling and knotting properties
- no capillarity
- excellent tissue passage

SUPRAMID is available as a monofilament, non-absorbable, surgical suture made from a copolymer of polyamide 6 and polyamide 6.6. In larger diameters, it is supplied as

a pseudo-monofilament, non-absorbable, surgical suture made from polyamide 6.6, a polymer of hexamethylenediamine and adipic acid with a polyamide-6 coating, a polymer of ϵ -caprolactam.

Special feature







The peptide structure of SUPRAMID allows it to degrade gradually after it has remained in the tissue for a while, despite its synthetic origin. This suture is therefore, with few exceptions, only suitable for skin sutures or for tissue that does not require permanent support.

The material is coloured with a physiologically harmless dye.

- Colour: white (no dye) or black
- Chemical name: monofilament: polyamide 6-6.6 pseudomonofilament: polyamide 6.6 and polyamide 6
- Thread diameter: USP 6-0 -2 (0.7-5 metric)
- Types of packaging:
 - needle-thread-combinations
 - in pre-cut lengths
- Sterilization method: ethylene oxide











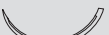

SUPRAMID

Sterile Nadel-Faden-Kombination / *needle suture combination, sterile*

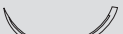
Nadel / needle	Stärke / gauge USP	gauge metric	Länge / length (m)	Farbe / colour	Best.-Nr. / code no.	Packungsinhalt / box content (Stück / pieces)
HRT = 1/2-Kreis schneidende Rundkörper						
<i>HRT = 1/2 circle, taper cutting</i>						
HRT 18 	4-0	1.5	0,50	schwarz / black	6061	36
	3-0	2	0,50	schwarz / black	6062	36
	4-0	1.5	0,75	schwarz / black	6063	36
	3-0	2	0,75	schwarz / black	6064	36
DR = 3/8-Kreis Rundkörper						
<i>DR = 3/8 circle, taper point</i>						
DR 18 	4-0	1.5	0,50	weiß / white	6070	36
● Schlinge / loop Tsuge-Naht / Tsuge Suture						
DRT = 3/8-Kreis schneidende Rundkörper						
<i>DRT = 3/8 circle, taper cutting</i>						
DRT 18 	4-0	1.5	0,50	weiß / white	6080	36
⊖ Schlinge / loop Tsuge-Naht / Tsuge Suture						
HS = 1/2-Kreis außen schneidend						
<i>HS = 1/2 circle, reverse cutting</i>						
HS 15 	4-0	1.5	0,45	schwarz / black	6118	36
	3-0	2	0,45	schwarz / black	6119	36
	4-0	1.5	0,75	schwarz / black	61112	36
HS 18 	5-0	1	0,45	schwarz / black	6111	36
	4-0	1.5	0,45	schwarz / black	6112	36
	3-0	2	0,45	schwarz / black	6114	36
	4-0	1.5	0,75	schwarz / black	61111	36
	3-0	2	0,75	schwarz / black	6117	36
HS 20 	3-0	2	0,45	schwarz / black	61113	36
	4-0	1.5	0,75	schwarz / black	61110	36
	3-0	2	0,75	schwarz / black	6116	36
HS 22 	3-0	2	0,45	schwarz / black	6113	36
	3-0	2	0,75	schwarz / black	61114	36
	2-0	3	0,75	schwarz / black	6115	36

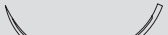
SUPRAMID

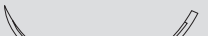
Sterile Nadel-Faden-Kombination / *needle suture combination, sterile*





Nadel / needle	Stärke / gauge		Länge / length (m)	Farbe / colour	Best.-Nr. / code no.	Packungsinhalt / box content (Stück / pieces)	
	USP	metric					
DS = 3/8-Kreis außen schneidend DSM = mit PREMIUM-Schliff <i>DS = 3/8 circle, reverse cutting</i> <i>DSM = PREMIUM cut</i>							
DSM 11 ▽ PREMIUM-Schliff / PREMIUM cut		6-0	0,7	0,45	schwarz / black	6151	36
		5-0	1	0,45	schwarz / black	6152	36
DS 13 ▼		5-0	1	0,45	schwarz / black	6141	36
		5-0	1	0,75	schwarz / black	61410	36
DSM 13 ▽ PREMIUM-Schliff / PREMIUM cut		5-0	1	0,45	schwarz / black	6158	36
		4-0	1,5	0,45	schwarz / black	6154	36
DS 16 ▼		4-0	1,5	0,45	schwarz / black	61432	36
DSM 16 ▽ PREMIUM-Schliff / PREMIUM cut		5-0	1	0,45	schwarz / black	6157	36
		4-0	1,5	0,75	schwarz / black	6153	36
DS 18 ▼		4-0	1,5	0,45	schwarz / black	6142	36
		3-0	2	0,45	schwarz / black	6143	36
		4-0	1,5	0,75	schwarz / black	61428	36
		3-0	2	0,75	schwarz / black	61429	36
		3-0	2	6 x 0,45	schwarz / black	M6144 (M)	12
		4-0	1,5	0,45	weiß / white	61430	36
		3-0	2	0,45	weiß / white	61431	36
DS 18 F ▼		4-0	1,5	0,45	schwarz / black	61420	36
DSM 18 ▽ PREMIUM-Schliff / PREMIUM cut		4-0	1,5	0,75	schwarz / black	6155	36
		3-0	2	0,75	schwarz / black	6156	36
DS 24 ▼		4-0	1,5	0,45	schwarz / black	6146	36
		3-0	2	0,45	schwarz / black	6147	36
		2-0	3	0,45	schwarz / black	61422	36
		3-0	2	0,75	schwarz / black	61425	36
		3-0	2	6 x 0,45	schwarz / black	M6148 (M)	12
		3-0	2	0,45	schwarz / black	61418*	36
DS 24 F ▼		5-0	1	0,45	schwarz / black	61418*	36
DS 30 ▼		2-0	3	0,45	schwarz / black	6149	36
		0	3,5	0,45	schwarz / black	61423	36
		2-0	3	0,75	schwarz / black	61426	36
		0	3,5	0,75	schwarz / black	61427	36
DS 40 ▼		3-0	2	0,45	schwarz / black	61412	36
		2-0	2,5	0,45	schwarz / black	61413	36
		0	3,5	0,75	weiß / white	61421	36

*eventuell mit verlängerter Lieferzeit verbunden / possibly associated with an extended delivery time

(M) = Multipack

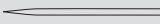
SUPRAMID

Sterile Nadel-Faden-Kombination / *needle suture combination, sterile*

Nadel / needle	Stärke / gauge		Länge / length (m)	Farbe / colour	Best.-Nr. / code no.	Packungsinhalt / box content (Stück / pieces)
	USP	metric				
GR = Gerade Rundkörper <i>GR= straight, taper point</i>						
GR 20 ● 	5-0	1.5	0,45	schwarz / black	6091	36
	4-0	1	0,45	schwarz / black	6090	36
	4-0	1.5	0,75	schwarz / black	6092	36
VSPM, VSPM F = 1/4-Kreis SPATULA PREMIUM-Schliff <i>VSPM, VSPM F = 1/4 circle, spatulated, PREMIUM cut</i>						
VSPM 8  PREMIUM-Schliff / <i>PREMIUM cut</i>	4-0	1.5	0,75	weiß / white	6211	24
2x VSPM 8  PREMIUM-Schliff / <i>PREMIUM cut</i>	4-0	1.5	0,25	weiß / white	6213	24
	4-0	1.5	0,45	weiß / white	6214	24
2 x VSPM 8 F  PREMIUM-Schliff / <i>PREMIUM cut</i>	5-0	1	0,45	weiß / white	6212	24

SUPRAMID

Einzelfadenpackungen, steril in vorgeschrittenen Längen / *Sterile pre-cut suture, non-needed*

Stärke / gauge USP		Länge / length (m)	Farbe / colour	Best.-Nr. / code no.	Packungsinhalt / box content (Stück / pieces)
4-0	1.5	3 x 0,50	schwarz / black	SAM335	24
3-0	2	3 x 0,50	schwarz / black	SAM435	24
2-0	3	3 x 0,50	schwarz / black	SAM535	24
0	3.5	3 x 0,50	schwarz / black	SAM635	24
1	4	3 x 0,50	schwarz / black	SAM735	24
4-0	1.5	3 x 0,50	weiß / white	M335	24
3-0	2	3 x 0,50	weiß / white	M435	24
2-0	3	3 x 0,50	weiß / white	M535	24
0	3.5	3 x 0,50	weiß / white	M635	24
1	4	3 x 0,50	weiß / white	M735	24
4-0	1.5	5 x 0,50	schwarz / black	SAM355	24
3-0	2	5 x 0,50	schwarz / black	SAM455	24
2-0	3	5 x 0,50	schwarz / black	SAM555	24
0	3.5	5 x 0,50	schwarz / black	SAM655	24
3-0	2	5 x 0,50	weiß / white	M455	24
2-0	3	5 x 0,50	weiß / white	M555	24
0	3.5	5 x 0,50	weiß / white	M655	24
3-0	2	10 x 0,50	schwarz / black	SAM4105	24
3-0	2	10 x 0,50	weiß / white	M4105	24
2-0	3	10 x 0,50	weiß / white	M5105	24



- nicht-resorbierbarer Seidenfaden
- hohe Geschmeidigkeit
- hervorragendes Knüpfverhalten
- maximale Zugfestigkeit

- *non-absorbable suture*
- *permanent pliability*
- *perfect knot security*
- *maximum tensile strength*

SEIDE / SILK

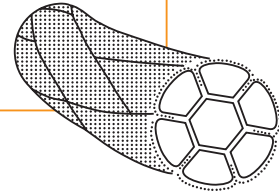

Eigenschaften:

- hohe Geschmeidigkeit
- hervorragendes Knüpfverhalten
- guter Knotensitz
- geringe Sägewirkung

Der Rohstoff für die Seidenherstellung ist das Gespinst (Kokon) der Seidenspinnerraupe.

Diese feinsten Kokonfäden werden entbastet (von der Kittsubstanz Sericin befreit), versponnen und präzisionsgeflochten.

Durch Oberflächenbehandlung wird der Seidenfaden imprägniert. Man erhält damit eine Seide ohne unerwünschte Dochtwirkung, also einen nichtkapillaren, Wasser abstoßenden Faden mit glatter Oberfläche. SEIDE ist mit einem physiologisch unbedenklichen Farbstoff eingefärbt.

- ➔ Farbe: schwarz
- ➔ Chemische Bezeichnung: Seidenfibroin
- ➔ Fadenstärke: USP 8-0 -3 (0.4-6 metric)
- ➔ Konfektionsangebote:
 - Nadel-Faden-Kombinationen
 - in vorgeschrittenen Längen
- ➔ Sterilisation: Ethylenoxid

Properties:

- *very supple*
- *excellent knotting properties*
- *excellent knot security*
- *minimal sawing effect*

The raw material for producing silk is the cocoon of the silkworm.









These very fine silk filaments undergo degumming (removing sericin, a viscous binding protein), spinning and precision-braiding.

A surface treatment waterproofs the silk filament. This process results in silk without any undesirable wicking, i.e. a non-capillary, hydrophobic suture with a smooth surface. SILK is coloured with a physiologically harmless dye.

- ➔ *Colour: black*
- ➔ *Chemical name: silk fibroin*
- ➔ *Thread diameter: USP 8-0 -3 (0.4-6 metric)*
- ➔ *Types of packaging:*
 - *needle-thread-combinations*
 - *precut lengths*
- ➔ *Sterilization method: ethylene oxide*







SEIDE / SILK

Sterile Nadel-Faden-Kombination / *needle suture combination, sterile*

Nadel / needle	Stärke / gauge		Länge / length (m)	Farbe / colour	Best.-Nr. / code no.	Packungsinhalt / box content (Stück / pieces)
	USP	metric				
HR, HRS = 1/2-Kreis Rundkörper						
<i>HR, HRS = 1/2 circle, taper point</i>						
HR 12 ● 	4-0	1.5	0,45	schwarz / black	4024N	24
HR 17 ● 	5-0	1	0,75	schwarz / black	4026N	24
	4-0	1.5	0,75	schwarz / black	4027N	24
	3-0	2	0,45	schwarz / black	40267N	24
	3-0	2	0,75	schwarz / black	4028 N	24
2 x HR 17 ● 	4-0	1.5	0,75	schwarz / black	40215N	24
HR 22 ● 	4-0	1.5	0,75	schwarz / black	40219N	24
	3-0	2	0,75	schwarz / black	40220N	24
	2-0	3	0,75	schwarz / black	40221N	24
HR 27 ● 	3-0	2	0,75	schwarz / black	40226 N	24
	2-0	3	0,75	schwarz / black	40227N	24
	0	3.5	0,75	schwarz / black	40228N	24
HR 30 ● 	2-0	3	0,75	schwarz / black	40238N	24
HR 35 ● 	2-0	3	0,75	schwarz / black	40242N	24
	0	3.5	0,75	schwarz / black	40243N	24
	2	5	0,75	schwarz / black	40245N	24
ART = Asymptotische schneidende Rundkörper						
<i>ART= asymptotic, taper cutting</i>						
ART 25 ⊙ 	3-0	2	0,45	schwarz / black	4283N	24



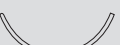
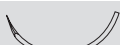









SEIDE / SILK

Sterile Nadel-Faden-Kombination / *needle suture combination, sterile*

Nadel / needle	Stärke / gauge USP metric	Länge / length (m)	Farbe / colour	Best.-Nr. / code no.	Packungsinhalt / box content (Stück / pieces)	
HRT = 1/2-Kreis schneidende Rundkörper <i>HRT = 1/2 circle, taper cutting</i>						
HRT 18 	4-0	1.5	0,45	schwarz / black	40616N	24
	3-0	2	0,45	schwarz / black	40615N	24
	2-0	3	0,45	schwarz / black	40617N	24
	4-0	1.5	0,75	schwarz / black	4062N	24
	3-0	2	0,75	schwarz / black	4063N	24
	2-0	3	0,75	schwarz / black	4064N	24
HRT 25 	3-0	2	0,75	schwarz / black	40610N	24
	2-0	3	0,75	schwarz / black	40611N	24
DR, DR F = 3/8-Kreis Rundkörper <i>DR, DR F = 3/8 circle, taper point</i>						
DR 10 F 	6-0	0.7	0,45	schwarz / black	4072N	24
DR 12 	4-0	1.5	0,75	schwarz / black	4079N	24
DR 18 	3-0	2	0,30	schwarz / black	40725N	24
DRN = 3/8-Kreis Rundkörper stumpf <i>DRN = 3/8 circle, blunt taper point</i>						
DRN 17 	3-0	2	0,30	schwarz / black	4273N	24
DRT = 3/8-Kreis schneidende Rundkörper <i>DRT = 3/8 circle, taper cutting</i>						
DRT 18 	3-0	2	0,75	schwarz / black	4083N	24
GR = Gerade Rundkörper <i>GR = straight, taper point</i>						
GR 20 	4-0	1.5	0,45	schwarz / black	40918N	24
	4-0	1.5	0,75	schwarz / black	4091N	24













SEIDE / SILK

Sterile Nadel-Faden-Kombination / *needle suture combination, sterile*

Nadel / needle	Stärke / gauge		Länge / length (m)	Farbe / colour	Best.-Nr. / code no.	Packungsinhalt / box content (Stück / pieces)
	USP	metric				
HS = 1/2-Kreis außen schneidend HSM, HSM F = mit PREMIUM-Schliff <i>HS = 1/2 circle, reverse cutting</i> <i>HSM, HSM F = PREMIUM cut</i>						
2 x HSM 10  ▽ PREMIUM-Schliff / <i>PREMIUM cut</i>	6-0	0.7	0,45	schwarz / <i>black</i>	4130N	24
HS 12 	5-0	1	0,45	schwarz / <i>black</i>	4111N	24
HSM 13  ▽ PREMIUM-Schliff / <i>PREMIUM cut</i>	5-0	1	0,45	schwarz / <i>black</i>	41210N	24
	4-0	1.5	0,45	schwarz / <i>black</i>	41211N	24
HS 18 	5-0	1	0,45	schwarz / <i>black</i>	4118N	24
	4-0	1.5	0,45	schwarz / <i>black</i>	4112N	24
	3-0	2	0,45	schwarz / <i>black</i>	4113N	24
	5-0	1	0,75	schwarz / <i>black</i>	41112N	24
	4-0	1.5	0,75	schwarz / <i>black</i>	4119N	24
HS 22 	3-0	2	0,45	schwarz / <i>black</i>	4116N	24
	2-0	3	0,45	schwarz / <i>black</i>	4117N	24
	3-0	2	0,75	schwarz / <i>black</i>	41113N	24
DS = 3/8-Kreis außen schneidend DSM, DSM F = mit PREMIUM-Schliff <i>DS = 3/8 circle, reverse cutting</i> <i>DSM, DSM F = PREMIUM cut</i>						
DSM 6  ▽ PREMIUM-Schliff / <i>PREMIUM cut</i>	8-0	0.4	0,30	schwarz / <i>black</i>	4154N	24
DSM 7 F  ▽ PREMIUM-Schliff / <i>PREMIUM cut</i>	7-0	0.5	0,30	schwarz / <i>black</i>	4157N	24
	6-0	0.7	0,30	schwarz / <i>black</i>	4158N	24
2 x DSM 7 F  ▽ PREMIUM-Schliff / <i>PREMIUM cut</i>	7-0	0.5	0,45	schwarz / <i>black</i>	4159N	24
	6-0	0.7	0,45	schwarz / <i>black</i>	41510N	24
DSM 11  ▽ PREMIUM-Schliff / <i>PREMIUM cut</i>	6-0	0.7	0,45	schwarz / <i>black</i>	41517N	24
DSM 11 F  ▽ PREMIUM-Schliff / <i>PREMIUM cut</i>	6-0	0.7	0,45	schwarz / <i>black</i>	41538N	24
2 x DSM 11 F  ▽ PREMIUM-Schliff / <i>PREMIUM cut</i>	6-0	0.7	0,45	schwarz / <i>black</i>	41519N	24
DS 13 	6-0	0.7	0,35	schwarz / <i>black</i>	4141N	24
	5-0	1	0,45	schwarz / <i>black</i>	4142N	24
	4-0	1.5	0,45	schwarz / <i>black</i>	4143N	24

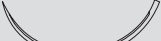
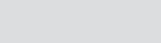

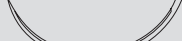







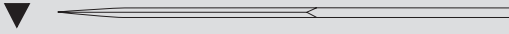





SEIDE / SILK

Sterile Nadel-Faden-Kombination / *needle suture combination, sterile*

Nadel / needle	Stärke / gauge USP	metric	Länge / length (m)	Farbe / colour	Best.-Nr. / code no.	Packungsinhalt / box content (Stück / pieces)
2 x DS 13 ▼ 	5-0	1	0,35	schwarz / black	4145N	24
DSM 13 ▽ PREMIUM-Schliff / PREMIUM cut 	6-0	0.7	0,45	schwarz / black	41542N	24
	5-0	1	0,45	schwarz / black	41520N	24
	4-0	1.5	0,45	schwarz / black	41521N	24
DS 16 ▼ 	6-0	0.7	0,45	schwarz / black	4147N	24
	5-0	1	0,45	schwarz / black	4148N	24
	4-0	1.5	0,45	schwarz / black	4149N	24
DSM 16 ▽ PREMIUM-Schliff / PREMIUM cut 	5-0	1	0,45	schwarz / black	41524N	24
	4-0	1.5	0,45	schwarz / black	41525N	24
DS 18 ▼ 	5-0	1	0,45	schwarz / black	41411N	24
	4-0	1.5	0,45	schwarz / black	41412N	24
	3-0	2	0,45	schwarz / black	41413N	24
	4-0	1.5	0,75	schwarz / black	41414N	24
	3-0	2	0,75	schwarz / black	41438N	24
DSM 18 ▽ 	4-0	1.5	0,45	schwarz / black	41527N	24
	2-0	3	0,45	schwarz / black	41529N	24
PREMIUM-Schliff / PREMIUM cut 	4-0	1.5	0,45	schwarz / black	41431N	24
DS 21 ▼ 	3-0	2	0,45	schwarz / black	41432N	24
	2-0	3	0,45	schwarz / black	41433N	24
DSM 21 ▽ 	4-0	1.5	0,45	schwarz / black	41534N	24
	2-0	3	0,45	schwarz / black	41536N	24
PREMIUM-Schliff / PREMIUM cut 	4-0	1.5	0,45	schwarz / black	41416N	24
DS 24 ▼ 	3-0	2	0,45	schwarz / black	41417N	24
	2-0	3	0,45	schwarz / black	41418N	24
	3-0	2	0,75	schwarz / black	41419N	24
	2-0	3	0,75	schwarz / black	41436N	24
DSM 24 ▽ 	2-0	3	0,75	schwarz / black	41531N	24
PREMIUM-Schliff / PREMIUM cut						
DS 27 ▼ 	2-0	3	0,45	schwarz / black	41422N	24
DS 30 ▼ 	2-0	3	0,45	schwarz / black	41424N	24
	0	3.5	0,45	schwarz / black	41425N	24
	2-0	3	0,75	schwarz / black	41426N	24
	0	3.5	0,75	schwarz / black	41428N	24
DS 40 ▼ 	0	3.5	0,75	schwarz / black	41430N	24
	1	4	0,75	schwarz / black	41437N	24

SEIDE / SILK

Sterile Nadel-Faden-Kombination / *needle suture combination, sterile*

Nadel / needle	Stärke / USP	gauge metric	Länge / length (m)	Farbe / colour	Best.-Nr. / code no.	Packungsinhalt / box content (Stück / pieces)
GS = Gerade schneidend <i>GS = straight, cutting</i>						
GS 60 	2-0	3	0,75	schwarz / black	4170N	24
HSPM, HSPM F = 1/2-Kreis SPATULA, PREMIUM-Schliff <i>HSPM, HSPM F = 1/2 circle, spatulated, PREMIUM cut</i>						
2 x HSPM 6 F   PREMIUM-Schliff / <i>PREMIUM cut</i>	8-0	0.4	0,30	schwarz / black	4195N	24
DSPM = 3/8-Kreis SPATULA, PREMIUM-Schliff <i>DSPM = 3/8 circle, spatulated, PREMIUM cut</i>						
DSPM 5   PREMIUM-Schliff / <i>PREMIUM cut</i>	8-0	0.4	0,30	schwarz / black	4202N	24
2 x DSPM 5   PREMIUM-Schliff / <i>PREMIUM cut</i>	8-0	0.4	0,30	schwarz / black	4206N	24
2 x DSPM 7   PREMIUM-Schliff / <i>PREMIUM cut</i>	8-0	0.4	0,45	schwarz / black	42015N	24
2 x DSPM 8   PREMIUM-Schliff / <i>PREMIUM cut</i>	7-0	0.5	0,45	schwarz / black	42021N	24
2 x DSPM 8   PREMIUM-Schliff / <i>PREMIUM cut</i>	6-0	0.7	0,45	schwarz / black	4208N	24
VSPM F = 1/4-Kreis SPATULA, PREMIUM-Schliff <i>VSPM F = 1/4 circle, spatulated, PREMIUM cut</i>						
2 x VSPM 8 F   PREMIUM-Schliff / <i>PREMIUM cut</i>	6-0	0.7	0,45	schwarz / black	4217N	24
2 x VSPM 8 F   PREMIUM-Schliff / <i>PREMIUM cut</i>	5-0	1	0,45	schwarz / black	4218N	24

SEIDE / SILK

Einzelfadenpackungen, steril in vorgeschnittenen Längen
Sterile pre-cut suture, non-needed

Stärke / gauge USP	metric	Länge / length (m)	Farbe / colour	Best.-Nr. / code no.	Packungsinhalt / box content (Stück / pieces)
3-0	2	5 x 0,35	schwarz / black	G453N	24
3-0	2	3 x 0,50	schwarz / black	G435N	24
2-0	3	3 x 0,50	schwarz / black	G535N	24
2	5	3 x 0,50	schwarz / black	G835N	24
4-0	1.5	5 x 0,50	schwarz / black	G355N	24
3-0	2	5 x 0,50	schwarz / black	G455N	24
2-0	3	5 x 0,50	schwarz / black	G555N	24
0	3.5	5 x 0,50	schwarz / black	G655N	24
1	4	5 x 0,50	schwarz / black	G755N	24
3-0	2	6 x 0,50	schwarz / black	SG455N	24
0	3.5	6 x 0,50	schwarz / black	SG655N	24
2	5	6 x 0,50	schwarz / black	SG855N	24
5-0	1	10 x 0,50	schwarz / black	G2105N	24
3-0	2	10 x 0,50	schwarz / black	G4105N	24
0	3.5	10 x 0,50	schwarz / black	G6105N	24
1	4	10 x 0,50	schwarz / black	G7105N	24
0	3.5	2 x 0,75	schwarz / black	G620N	24
1	4	2 x 0,75	schwarz / black	G720N	24
2	5	2 x 0,75	schwarz / black	G820N	24
3	6	2 x 0,75	schwarz / black	G920N	24
2-0	3	5 x 0,75	schwarz / black	G550N	24
0	3.5	5 x 0,75	schwarz / black	G650N	24
1	4	5 x 0,75	schwarz / black	G750N	24
2	5	5 x 0,75	schwarz / black	G850N	24
3-0	2	1 x 1,40	schwarz / black	SG411N	24
2-0	3	1 x 1,40	schwarz / black	SG511N	24

STAHLDRAHT / STAINLESS STEEL

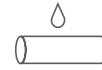

- nicht-resorbierbarer Stahldraht
- monofil
- hohe Zugfestigkeit
- sehr gewebefreundlich
- keine Dehnung

- *non-absorbable steel wire*
- *monofilament*
- *high tensile strength*
- *completely non-irritating*
- *non-stretch*

STAHLDRAHT / *STAINLESS STEEL*

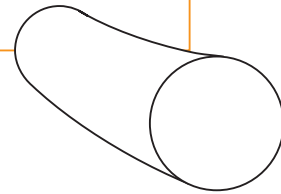

Eigenschaften:

- hohe, gleichbleibende Reißkraft
- keine Dehnung
- sehr geringe Gewebereaktion
- keine Dochtwirkung

Ein Mineralprodukt, hergestellt aus nichtrostender, korrosionsbeständiger Stahllegierung.

Aus flüssigem Stahl werden durch Formwerkzeuge Stahlfasern in den benötigten Stärken gezogen.

- Chemische Bezeichnung: nichtrostender Stahldraht
- Fadenstärke: USP 6-0 -7 (0.7-9 metric)
- Konfektionsangebote:
 - Nadel-Faden-Kombinationen
 - in vorgeschrittenen Längen
- Sterilisation: Ethylenoxid

Properties:

- *high, unchanging tear resistance*
- *no stretching*
- *minimal tissue reaction*
- *no wicking effect*



A mineral product manufactured from a stainless, non-corroding steel alloy.

Steel fibres are drawn from liquid steel through a suitable die to the required diameters.

- *Chemical name: stainless steel*
- *Thread diameter: USP 6-0 -7 (0.7-9 metric)*
- *Types of packaging:*
 - *needle-thread-combinations*
 - *precut lengths*
- *Sterilization method: ethylene oxide*

STAHLDRAHT / STAINLESS STEEL

Sterile Nadel-Faden-Kombination / *needle suture combination, sterile*

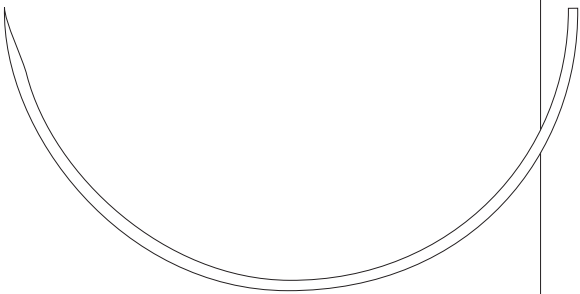
Nadel / needle	Stärke / gauge		Länge / length (m)	Farbe / colour	Best.-Nr. / code no.	Packungsinhalt / box content (Stück / pieces)
	USP	metric				
HRTX = 1/2-Kreis schneidende Rundkörper						
<i>HRTX = 1/2 circle, taper cutting</i>						
HRTX 50  Sternum-Naht / <i>Sternum-Suture</i>	5	7	1 x 0,45	monofil <i>monofilament</i>	L99061 (M-L)	12
	6	8	1 x 0,45	monofil <i>monofilament</i>	L99071 (M-L)	12
	7	9	1 x 0,45	monofil <i>monofilament</i>	L99069 (M-L)	12
	5	7	4 x 0,45	monofil <i>monofilament</i>	L99063 (M-L)	12
	6	8	4 x 0,45	monofil <i>monofilament</i>	L99064 (M-L)	12
	7	9	4 x 0,45	monofil <i>monofilament</i>	L99065 (M-L)	12
	5	7	6 x 0,45	monofil <i>monofilament</i>	L99066 (M-L)	12
	6	8	6 x 0,45	monofil <i>monofilament</i>	L99067 (M-L)	12
	7	9	6 x 0,45	monofil <i>monofilament</i>	L99070 (M-L)	12
	6	8	8 x 0,45	monofil <i>monofilament</i>	L99068 (M-L)	12
HS = Kreis außen schneidend						
<i>HS = 1/2 circle, reverse-cutting</i>						
HS 35 	2-0	3	0,60	monofil <i>monofilament</i>	99112	36
HS 120  Patella-Naht / <i>Patella-Suture Set</i>	3	6	0,60	monofil <i>monofilament</i>	99115	6

(M-L) = Multi-L-Pack

STAHLDRAHT / STAINLESS STEEL

Sterile Nadel-Faden-Kombination / *needle suture combination, sterile*

Nadel / needle	Stärke / gauge USP metric	Länge / length (m)	Farbe / colour	Best.-Nr. / code no.	Packungsinhalt / box content (Stück / pieces)	
DS, DSM = 3/8-Kreis außen schneidend, mit PREMIUM-Schliff <i>DS; DSM = 3/8 circle, reverse cutting, PREMIUM cut</i>						
DSM 13 ▽ PREMIUM-Schliff / <i>PREMIUM cut</i>	5-0	1	0,45	monofil <i>monofilament</i>	99157	36
DS 18 ▼	5-0	1	0,45	monofil <i>monofilament</i>	99144	36
DS 26 ▼	1	4	0,45	monofil <i>monofilament</i>	L991418 (M-L)	12
DS 30 ▼ Sternum-Naht / <i>Sternum-suture</i>	2	5	1 x 0,45	monofil <i>monofilament</i>	L991417 (M-L)	12
	3	6	1 x 0,75	monofil <i>monofilament</i>	L991416 (M-L)	12

(M-L) = Multi-L-Pack

STAHLDRAHT / STAINLESS STEEL

Einzelfadenpackungen, steril in vorgeschnittenen Längen
Sterile pre-cut suture, non-needed

Stärke / gauge USP metric	Länge / length (m)	Farbe / colour	Best.-Nr. / code no.	Packungsinhalt / box content (Stück / pieces)	
2-0	3 5	x 0,15	monofil <i>monofilament</i>	V551	24
0	3.5	5 x 0,15	monofil <i>monofilament</i>	V651	24
0	3.5	3 x 0,50	monofil <i>monofilament</i>	V635	24
1	4	3 x 0,50	monofil <i>monofilament</i>	V735	24

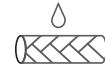

- nicht-resorbierbar, synthetisch
- extrem hohe Reißkraft
- belastbarer und sicherer Knotensitz
- minimale Gewebereaktion

- *non-absorbable, synthetic*
- *extremely high tensile strength*
- *high knot security*
- *excellent biocompatibility*

RESORBA® OT-Cord

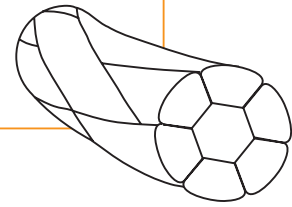

Eigenschaften:

- Geflochtenes Nahtmaterial mit einem robusten Faserkern, welcher als Grundlage für bessere Knüpfesigenschaften dient
- Herausragende Reißkraft: Auf gewichteter Basis stärker als Stahl
- Hohe Biegefestigkeit
- E-braid Flechttechnik für eine bessere Handhabung und eine ausgezeichnete Knotenfestigkeit
- Farbfilamente zur besseren Sichtbarkeit

RESORBA® OT-Cord wird aus UHMWPE (Ultrahochmolekulargewichtiges Polyethylen) hergestellt.

Aufgrund der nicht-resorbierbaren Eigenschaften und der herausragenden Festigkeit, ist RESORBA® OT-Cord besonders gut geeignet für die permanente Wundunterstützung.

RESORBA® OT-Cord ist in weiß erhältlich.

- ➔ Farbe: weiß
- ➔ Chemische Bezeichnung: UHMWPE
- ➔ Fadenstärke: 4-0 - 2 (1.5 - 5 metric)
- ➔ Konfektionsangebote:
 - Nadel-Faden-Kombinationen
 - in vorgeschrittenen Längen
- ➔ Sterilisation: Ethylenoxid

Properties:

- Braided suture with all fibre configuration with sturdy central core as backbone for better knotting
- Excellent strength: stronger than steel on a weighted basis
- High flexural strength
- E-braid construction for better handling and excellent knot strength
- Vibrant tracer colours for enhanced visibility

RESORBA® OT-Cord is made of UHMWPE (Ultra High Molecular Weight Poly-Ethylene).











Because of its non-absorbable profile, and outstanding strength, RESORBA® OT-Cord is well suited for permanent wound support.

RESORBA® OT-Cord is available in white.

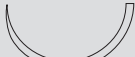
- ➔ Colour: White
- ➔ Chemical name: UHMWPE
- ➔ Thread diameter: USP 4-0 - 2 (1.5 - 5 metric)
- ➔ Types of packaging:
 - needle thread combinations
 - precut lengths
- ➔ Sterilisation method: ethylene oxide

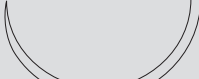
RESORBA® OT-Cord

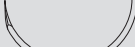

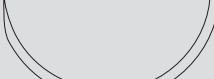

Sterile Nadel-Faden-Kombination / *needle suture combination, sterile*

Nadel / needle	Stärke / gauge		Länge / length (m)	Farbe / colour	Best.-Nr. / code no.	Packungsinhalt / box content (Stück / pieces)
	USP	metric				
HR, HRS = 1/2-Kreis Rundkörper <i>HR, HRS = 1/2 circle, taper point</i>						
HR 12 ● 	4-0	1.5	0,45	weiß / white	110201N*	12
	3-0	2	0,45	weiß / white	110202N*	12
	2-0	3	0,45	weiß / white	110203N*	12
HR 17 ● 	4-0	1.5	0,45	weiß / white	110204N*	12
	3-0	2	0,45	weiß / white	110205N*	12
	2-0	3	0,45	weiß / white	110206N	12
HRS 17 ● 	4-0	1.5	0,70	weiß / white	110301N*	12
	3-0	2	0,70	weiß / white	110302N*	12
	2-0	3	0,70	weiß / white	110303N*	12
	0	3.5	0,70	weiß / white	110304N*	12
HRS 22 ● 	2-0	3	0,90	weiß / white	110305N	12
	0	3.5	0,90	weiß / white	110306N*	12
	2	5	0,90	weiß / white	110307N	12
HRS 27 ● 	3-0	2	0,90	weiß / white	110308N*	12
	2-0	3	0,90	weiß / white	110309N*	12
	0	3.5	0,90	weiß / white	110310N*	12
	2	5	0,90	weiß / white	110311N	12
HRS 35 ● 	0	3.5	0,90	weiß / white	110312N*	12
	1	4	0,90	weiß / white	110313N*	12
	2	5	0,90	weiß / white	110314N	12
HRS 40 ● 	0	3.5	0,90	weiß / white	110315N*	12
	2	5	0,90	weiß / white	110316N*	12
HRT = 1/2-Kreis schneidende Rundkörper <i>HRT = 1/2 circle, taper cutting</i>						
HRT 18 ▼ 	3-0	2	0,90	weiß / white	110601N*	12
	2-0	3	0,90	weiß / white	110602N	12
	0	3.5	0,90	weiß / white	110603N*	12
HRT 22 ▼ 	2-0	3	0,90	weiß / white	110604N*	12
	0	3.5	0,90	weiß / white	110605N*	12
	2	5	0,90	weiß / white	110606N*	12
HRT 25 ▼ 	0	3.5	0,90	weiß / white	110607N*	12
	2	5	0,90	weiß / white	110608N	12
HRTX 35 ▼ 	2-0	3	0,90	weiß / white	110609N*	12
	0	3.5	0,90	weiß / white	110610N*	12
	2	5	0,90	weiß / white	110611N	12
HRTX 45 ▼ 	2	5	0,90	weiß / white	110612N*	12

* auf Anfrage bestellbar / bitte verlängerte Lieferzeit beachten
can be ordered on request / please note extended delivery time

RESORBA® OT-Cord

Sterile Nadel-Faden-Kombination / *needle suture combination, sterile*

Nadel / needle	Stärke / gauge		Länge / length (m)	Farbe / colour	Best.-Nr. / code no.	Packungsinhalt / box content (Stück / pieces)
	USP	metric				
HS = 1/2-Kreis außen schneidend <i>HS = 1/2 circle, reverse cutting</i>						
HS 27 ▼ 	2-0	3	0,90	weiß / white	111101N	12
	0	3.5	0,90	weiß / white	111102N*	12
	2	5	0,90	weiß / white	111103N	12
HS 35 ▼ 	2-0	3	0,90	weiß / white	111104N*	12
	0	3.5	0,90	weiß / white	111105N*	12
	2	5	0,90	weiß / white	111106N*	12
HS 40 ▼ 	0	3.5	0,90	weiß / white	111107N*	12
	2	5	0,90	weiß / white	111108N	12
HSX 22 ▼ 	2	5	0,90	weiß / white	111301N	12
GRT = Gerade schneidende Rundkörper <i>GRT = straight, taper cutting</i>						
GRT 40 Ⓢ 	2	5	0,70	weiß / white	111001N	12

RESORBA® OT-Cord

Einzelfadenpackungen, steril in vorgeschrittenen Längen
Sterile pre-cut suture, non-needled

Stärke / gauge	Länge / length (m)	Farbe / colour	Best.-Nr. / code no.	Packungsinhalt / box content (Stück / pieces)	
					USP
4-0	1.5	2 x 0,70	weiß / white	114000N*	12
3-0	2	2 x 0,70	weiß / white	113000N*	12
2-0	3	2 x 0,70	weiß / white	112000N*	12
0	3.5	2 x 0,70	weiß / white	110000N*	12
2	5	2 x 0,70	weiß / white	110200N	12

* auf Anfrage bestellbar / bitte verlängerte Lieferzeit beachten
can be ordered on request / please note extended delivery time

Dental-Kombinationen

Dental Special Products

GLYCOLON® ORAL
RESOTEX® ORAL
SUPRAMID ORAL
DENTOFIL™

GLYCOLON® ORAL



- kurzfristig resorbierbares Monofilament
- hohe Reißkraft
- glatter Gewebedurchzug
- minimale Gewebereaktion
- guter Knotensitz

- *short term absorbable monofilament*
- *high tensile strength*
- *smooth tissue passage*
- *minimized tissue trauma*
- *perfect knot security*

GLYCOLON® ORAL

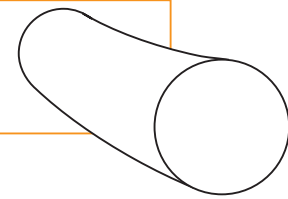

Eigenschaften:

- hohe Reißkraft
- guter Knotensitz
- atraumatischer Gewebedurchzug

Zur Herstellung von GLYCOLON® ORAL werden die beiden Materialbestandteile Polyglykolsäure und ϵ -Caprolacton in einem bestimmten Verhältnis copolymerisiert. Der Abbau des polymeren Fadenmaterials

im Gewebe erfolgt durch Wasseraufnahme in Umkehrung der Synthese. Nach Implantation nimmt die Reißkraft von GLYCOLON® ORAL nach 7 Tagen auf 30% ab.

Gewebereaktionen werden zum einen durch die dabei entstehenden unbedenklichen Zwischenprodukte, zum anderen durch die monofile und glatte Oberflächenstruktur des Fadens minimiert.

GLYCOLON® ORAL besitzt durch die glatten und monofilen Oberflächenstrukturen des Polymers ausgezeichnete Eigenschaften des Handlings und der Gleitfähigkeit.

Gewebetraumatisierungen durch den Fadendurchzug sind bei

GLYCOLON® ORAL nicht relevant, die monofile Struktur verhindert Dochtwirkungen des Fadens ohne zusätzliche Oberflächenbehandlung. GLYCOLON® ORAL ist violett (mit dem physiologisch unbedenklichen Farbstoff D+C Nr. 2) eingefärbt erhältlich.

- ➔ Farbe: violett
- ➔ Chemische Bezeichnung: [Poly(Glykolsäure-co- ϵ -Caprolacton)]
- ➔ Fadenstärke: USP 5-0 (1 metric)
- ➔ Konfektionsangebote:
 - Nadel-Faden-Kombinationen
- ➔ Sterilisation: Ethylenoxid

Properties:

- high tear resistance
- excellent knot security
- atraumatic tissue passage

The two material components polyglycolic acid and ϵ -caprolactone are copolymerized in a certain ratio to make GLYCOLON® ORAL. Metabolization of the polymer suture within the tissue occurs by the uptake of water, thus reversing the synthesis.

The tear resistance of GLYCOLON® ORAL reduces by 30% 7 days after implantation.

Tissue reaction is minimal because of the completely safe intermediary products and the monofilament structure of thread.



GLYCOLON® ORAL with its smooth surface provides excellent handling properties and very good passage through tissue. Tissue trauma is minimal and there is no undesirable wick effect due to the monofilament structure of GLYCOLON® ORAL.

GLYCOLON® ORAL is supplied violet (dyed with the physiologically safe dye D+C No. 2).

- ➔ Colour: violet
- ➔ Chemical name: [poly (glycolic acid-co- ϵ -caprolactone)]
- ➔ Thread diameter: USP 5-0 (1 metric)
- ➔ Types of packaging:
 - needle-thread-combinations
- ➔ Sterilization method: ethylene oxide

GLYCOLON® ORAL

Sterile Nadel-Faden-Kombination / *needle suture combination, sterile*

Nadel / needle	Stärke / gauge		Länge / length (m)	Farbe / colour	Best.-Nr. / code no.	Packungsinhalt / box content (Stück / pieces)
	USP	metric				
DSM = 3/8-Kreis außen schneidend, mit PREMIUM-Schliff <i>DSM = 3/8 circle, reverse cutting, Premium cut</i>						
DSM 13 ▽  PREMIUM-Schliff / <i>PREMIUM cut</i>	5-0	1	0,45	violett / violet	DB15002S	12
DSM 16 ▽  PREMIUM-Schliff / <i>PREMIUM cut</i>	5-0	1	0,45	violett / violet	DB15001S	12
DSM 18 ▽  PREMIUM-Schliff / <i>PREMIUM cut</i>	5-0	1	0,45	violett / violet	DB15003S	12

RESOTEX® ORAL



- nicht-resorbierbares Material
 - überdurchschnittlich geschmeidig und weich
 - sehr gute Knüpfeigenschaften
 - hervorragender Gewebedurchzug
 - keine Kapillarität
 - geringe Gewebereaktion
- *non-absorbable suture*
 - *softer and more supple than average*
 - *perfect handling and knotting*
 - *easy passage through tissue*
 - *no capillarity*
 - *non-irritating*

RESOTEX® ORAL

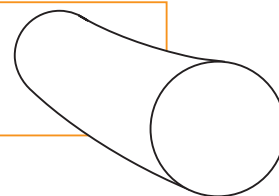

Eigenschaften:

- überdurchschnittlich weich und geschmeidig
- sehr gute Handhabungs- und Knüpfeigenschaften
- keine Kapillarität
- hervorragendes Gewebedurchzugsverhalten

RESOTEX® ORAL ist ein monofiles, nichtresorbierbares Nahtmaterial für die Oralchirurgie aus einem Copolymerisat aus Polyamid 6 und Polyamid 6.6. Durch seine monofile Struktur werden ohne zusätzliche Beschichtung eine Dochtwirkung und Gewebetraumatisierungen beim Fadendurchzug vermieden.

Das Material ist mit einem physiologisch unbedenklichen Farbstoff eingefärbt.

- Farbe: schwarz
- Chemische Bezeichnung: Polyamid 6-6.6
- Fadenstärke: USP 7-0 – 4-0 (0.5-1.5 metric)
- Konfektionsangebote:
 - Nadel-Faden-Kombinationen
- Sterilisation: Ethylenoxid

Properties:

- above-average softness and suppleness
- superior handling and knotting properties
- no capillarity
- excellent tissue passage

RESOTEX® ORAL is a monofilament, non-absorbable surgical suture material for oral surgery made from a copolymer of polyamide 6 and polyamide 6/6.







The monofilament structure without an additional coating prevents the wick effect and tissue trauma during passage through tissue.

The material is colored with a physiologically safe dye.

- Colour: black
- Chemical name: polyamide 6-6.6
- Thread diameter: USP 7-0 – 4-0 (0.5 - 1.5 metric)
- Types of packaging:
 - needle-thread-combinations
- Sterilization method: ethylene oxide

RESOTEX® ORAL

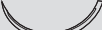
Sterile Nadel-Faden-Kombination / *needle suture combination, sterile*

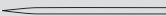
Nadel / needle	Stärke / gauge		Länge / length (m)	Farbe / colour	Best.-Nr. / code no.	Packungsinhalt / box content (Stück / pieces)
	USP	metric				
ART = Asymptotische schneidende Rundkörper <i>ART = asymptotic, taper cutting</i>						
ART 13 ☉ 	6-0	0.7	0,45	schwarz / black	DB23001S	12
HRT = 1/2-Kreis schneidende Rundkörper <i>HRT = 1/2 circle, taper cutting</i>						
HRT 18 ☉ 	4-0	1.5	0,45	schwarz / black	DB22001S	12
DSM = 3/8-Kreis außen schneidend, mit PREMIUM-Schliff <i>DSM = 3/8 circle, reverse cutting, PREMIUM cut</i>						
DSM 11 ▽ 	6-0	0.7	0,45	schwarz / black	DB25007S	12
DSM 13 ▽ 	7-0	0.5	0,45	schwarz / black	DB25004S	12
	6-0	0.7	0,45	schwarz / black	DB25001S	12
	5-0	1	0,45	schwarz / black	DB25005S	12
DSM 16 ▽ 	5-0	1	0,45	schwarz / black	DB25003S	12
	4-0	1.5	0,45	schwarz / black	DB25002S	12
DSM 18 ▽ 	5-0	1	0,45	schwarz / black	DB25006S	12
GR = Gerade Rundkörper <i>GR = straight, taper point</i>						
GR 22 ● 	4-0	1.5	0,45	schwarz / black	DB28001S	12

SUPRAMID ORAL

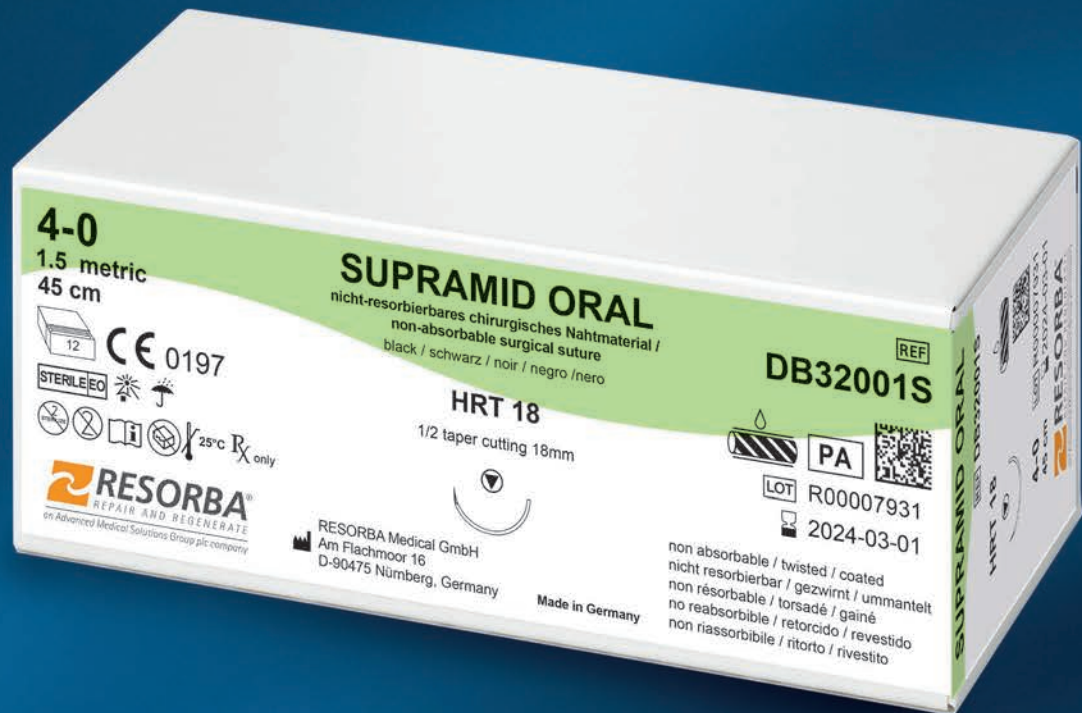

- nicht-resorbierbarer Polyamid-Faden
- sehr geschmeidig
- zugfest
- geringe Gewebereaktion
- gute Knoteneigenschaften

- *non-absorbable polyamide-suture*
- *very soft*
- *high tensile strength*
- *less tissue reaction*
- *good knotting properties*

SUPRAMID ORAL

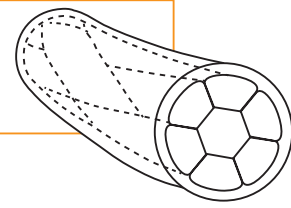

Eigenschaften:

- überdurchschnittlich weich und geschmeidig
- sehr gute Handhabungs- und Knüpfeigenschaften
- keine Kapillarität
- hervorragendes Gewebedurchzugsverhalten

SUPRAMID ORAL ist als pseudomonofiles, nichtresorbierbares Nahtmaterial aus einem Copolymerisat aus Polyamid 6 und Polyamid 6.6 erhältlich.

Dieses pseudomonofile, nicht-resorbierbare, chirurgische Nahtmaterial besteht aus Polyamid 6.6, einem Polymer von Hexamethyldiamin und Adipinsäure, mit einer Beschichtung aus Polyamid 6, einem ϵ -Caprolactam-Polymer.

Das Material ist mit einem physiologisch unbedenklichen Farbstoff eingefärbt.

- Farbe: schwarz
- Chemische Bezeichnung: Polyamid 6-6.6
- Fadenstärke: USP 4-0 (1.5 metric)
- Konfektionsangebote:
 - Nadel-Faden-Kombinationen
- Sterilisation: Ethylenoxid

Properties:

- above-average softness and suppleness
- superior handling and knotting properties
- no capillarity
- excellent tissue passage

SUPRAMID ORAL is a pseudo-monofilament, non-absorbable surgical suture material for oral surgery made from a copolymer of polyamide 6 and polyamide 6/6.



This pseudo-monofilament, non-absorbable, surgical suture material consists of polyamide 6/6, a polymer of hexamethylenediamine and adipic acid with a coating of polyamide 6, a ϵ -caprolactam-polymer.

The material is colored with a physiologically safe dye.

- Colour: black
- Chemical name: polyamide 6.6 and polyamide 6
- Thread diameter: USP 4-0 (1.5 metric)
- Types of packaging:
 - needle-thread-combinations
- Sterilization method: ethylene oxide

SUPRAMID ORAL

Sterile Nadel-Faden-Kombination / *needle suture combination, sterile*

Nadel / needle	Stärke / gauge		Länge / length (m)	Farbe / colour	Best.-Nr. / code no.	Packungsinhalt / box content (Stück / pieces)
	USP	metric				
HRT = 1/2-Kreis schneidende Rundkörper (Diamond-Spitze)						
<i>HRT = 1/2 circle, taper cutting</i>						
HRT 18 ⊙	4-0	1.5	0,45	schwarz / black	DB32001S	12
						
HS = 1/2-Kreis außen schneidend						
<i>HS = 1/2 circle, reverse cutting</i>						
HS 18 ▼	4-0	1.5	0,45	schwarz / black	DB31001S	12
						

DENTOFIL™



- PTFE Nahtmaterial
- nicht resorbierbar
- sehr geschmeidig
- sehr reißfest
- gut knüpfbar
- biologisch neutral

- *PTFE Suture Material*
- *non-absorbable*
- *extremely smooth*
- *very strong*
- *knots well*
- *biologically inert*

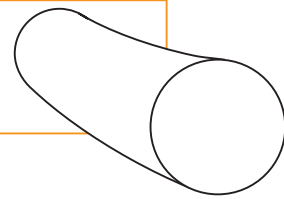

Eigenschaften:

- sehr geringe Reibung des monofilen Fadens minimiert mögliche Gewebeschäden
- atraumatische, öhrlose Nadeln gewährleisten geringsten Widerstand beim Einstich und Gleiten durch das Gewebe

DENTOFIL™ ist ein nicht resorbierbares, sehr geschmeidiges Nahtmaterial aus Polytetrafluorethylen (PTFE), das sehr reißfest, gut knüpfbar und biologisch neutral ist.

Besonders hervorzuheben ist die Geschmeidigkeit von DENTOFIL™, die dem Patientenkomfort sehr

zutraglich ist. Das Material hat einen sehr geringen Reibungskoeffizienten, d. h. im Vergleich zu anderen Materialien gleitet es leicht durch das Gewebe und minimiert dadurch die Wahrscheinlichkeit von Gewebeschäden. Diese Eigenschaft und die monofile Beschaffenheit verhindern die Möglichkeit des Eindringens von Bakterien in die Operationswunde.

Die atraumatischen, öhrlosen Nadeln sind aus einem nichtrostenden Spezialstahl mit optimaler Flexibilität und Festigkeit hergestellt. Eine spezielle Oberflächenbehandlung und ein präziser Schliff der Spitze bzw. Schneide gewährleisten geringsten Widerstand beim Einstich und beim Gleiten der Nadel durch das Gewebe. Die Prüfung der Nadelhaltekraft

erfolgt nach den Vorschriften der harmonisierten Normen für chirurgisches Nahtmaterial abgeleitet von der Europäischen Pharmakopoe.

DENTOFIL™ ist ein ideales Nahtmaterial für den Wundverschluss in der MKG-Chirurgie, z.B. nach augmentativen Verfahren und anderen implantologischen Eingriffen, bei denen die Verwendung eines weichen monofilen Fadens von Vorteil ist.

- ➔ Farbe: weiß
- ➔ Chemische Bezeichnung: Polytetrafluorethylen (PTFE)
- ➔ Fadenstärke: USP 5-0 - 3-0 (1 - 2 metric)
- ➔ Konfektionsangebote:
 - Nadel-Faden-Kombinationen
- ➔ Sterilisation: Ethylenoxid

Properties:

- very low friction of the thread minimizes the possibility of tissue damage
- atraumatic eyeless needles ensure minimal resistance to penetration and easy passage through the tissue

DENTOFIL™ is a non-absorbable, extremely smooth suture material made from polytetrafluoroethylene (PTFE) that is very strong, knots well, and is biologically inert.

Of particular note is the softness of DENTOFIL™, which makes it well

suited for patient comfort.

The material has a very low friction coefficient, meaning it slides easily through tissue compared to other materials, thereby limiting the possibility of tissue damage.

This feature, along with the monofilament construction, prevents the possibility of bacterial wicking into the surgical site.

The atraumatic eyeless needles are manufactured from special stainless steel of optimal flexibility and strength. Special surface treatment and precision grinding of needle points and cutting edges ensure minimal resistance to penetration and easy passage of the needle through the tissue. Testing of the needle holding force is performed









in accordance with the harmonised norms for surgical suture material derived from the European Pharmacopoeia.

DENTOFIL™ is an ideal suture material for wound closure in oral and maxillofacial surgery, including following bone grafts and other implant procedures where the use of a strong, smooth monofilament suture is highly beneficial.

- ➔ Colour: white
- ➔ Chemical name: polytetrafluoroethylene (PTFE)
- ➔ Thread diameter: USP 5-0 - 3-0 (1 - 2 metric)
- ➔ Types of packaging:
 - needle-thread-combinations
- ➔ Sterilization method: ethylene oxide

DENTOFIL™

Steriles PTFE Nahtmaterial / *PTFE Suture Material, sterile*

Nadel / needle	Stärke / gauge		Länge / length (m)	Farbe / colour	Best.-Nr. / code no.	Packungsinhalt / box content (Stück / pieces)
	USP	metric				
HR = 1/2-Kreis Rundkörper <i>HR = 1/2 circle, taper point</i>						
HR 13 ● 	4-0	1.5	0,45	weiß / white	DB46001	12
HRT = 1/2-Kreis schneidende Rundkörper (Diamond-Spitze) <i>HRT = 1/2 circle, taper cutting</i>						
HRT 17 ▼ 	4-0	1.5	0,45	weiß / white	DB42004	12
	4-0	1.5	0,75	weiß / white	DB42003	12
	3-0	2	0,75	weiß / white	DB42002	12
HRT 22 ▼ 	3-0	2	0,75	weiß / white	DB42001	12
DSM = 3/8-Kreis außen schneidend, mit PREMIUM-Schliff <i>DSM = 3/8 circle, reverse cutting, PREMIUM cut</i>						
DSM 11 ▽ 	5-0	1	0,45	weiß / white	DB45006	12
DSM 13 ▽ 	5-0	1	0,45	weiß / white	DB45007	12
	4-0	1.5	0,45	weiß / white	DB45002	12
DSM 16 ▽ 	5-0	1	0,45	weiß / white	DB45008	12
	4-0	1.5	0,45	weiß / white	DB45001	12
	3-0	2	0,45	weiß / white	DB44001	12
DSM 19 ▽ 	4-0	1.5	0,45	weiß / white	DB45005	12
	3-0	2	0,45	weiß / white	DB44002	12
GR = Gerade Rundkörper <i>GR = straight, taper point</i>						
GR 22 ● 	4-0	1.5	0,45	weiß / white	DB48001	12



Spezialkombinationen *Special Products*











Spezial-Kombinationen / *Special Products*

Beschreibung / <i>description</i>	Länge / <i>length</i> (m)	Best.-Nr. / <i>code no.</i>	Packungsinhalt / <i>box content</i> (Stück / <i>pieces</i>)
Halteband, auch Nabel-, Zügelband <i>Tapes, umbilical threads</i>			
Nabel-, Zügelband, Baumwolle, weiß, geflochten, flach, 5 mm breit <i>Umbilical thread, cotton, white, braided, 5 mm</i>	0,75	104	12
ResoLOOPS			
Anschlingsschlauch (Retraktion) aus Silikon Kautschuk, steril im Folienbeutel <i>Silicone rubber encircling (retraction) loop, sterile in foil pouch</i>			
Ø 1,5 mm x 1,0 mm weiß / <i>white</i>	2 x 0,45	R15W	24
Ø 1,5 mm x 1,0 mm rot / <i>red</i>	2 x 0,45	R15R	24
Ø 1,5 mm x 1,0 mm blau / <i>blue</i>	2 x 0,45	R15B	24
Ø 1,5 mm x 1,0 mm gelb / <i>yellow</i>	2 x 0,45	R15G	24
Ø 2,5 mm x 1,0 mm weiß / <i>white</i>	2 x 0,45	R25W	12
Ø 2,5 mm x 1,0 mm rot / <i>red</i>	2 x 0,45	R25R	12
Ø 2,5 mm x 1,0 mm blau / <i>blue</i>	2 x 0,45	R25B	12
Ø 2,5 mm x 1,0 mm gelb / <i>yellow</i>	2 x 0,45	R25G	12
Ø 2,5 mm x 1,0 mm rot / <i>red</i>	2 x 0,75	R257R	12
Ø 2,5 mm x 1,0 mm blau / <i>blue</i>	2 x 0,75	R257B	12
Ø 2,5 mm x 1,0 mm gelb / <i>yellow</i>	2 x 0,75	R257G	12
Ø 5,0 mm x 1,0 mm weiß / <i>white</i>	2 x 0,45	R50W	12
Ø 5,0 mm x 1,0 mm rot / <i>red</i>	2 x 0,45	R50R	12
Ø 5,0 mm x 1,0 mm blau / <i>blue</i>	2 x 0,45	R50B	12
Ø 5,0 mm x 1,0 mm gelb / <i>yellow</i>	2 x 0,45	R50G	12
Ø 5,0 mm x 1,0 mm weiß / <i>white</i>	1 x 0,75	R507W	12
Ø 5,0 mm x 1,0 mm rot / <i>red</i>	1 x 0,75	R507R	12
Ø 5,0 mm x 1,0 mm blau / <i>blue</i>	1 x 0,75	R507B	12
Ø 5,0 mm x 1,0 mm gelb / <i>yellow</i>	1 x 0,75	R507G	12
ResoLOOPS dürfen nicht implantiert oder resterilisiert werden. <i>ResoLOOPS must not be implanted or resterilized.</i>			

Spezial-Kombinationen / Special Products

Beschreibung / description	Nadel / needle	Stärke / gauge USP	gauge metric	Länge / length (m)	Best.-Nr. / code no.	Packungsinhalt / box content (Stück / pieces)
Patella-Naht <i>Patella Suture</i>						
Draht monofil / <i>Steel monofil</i>	HS 120	3	6	0,60	99115	6

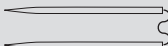
Nadel / needle	Stärke / gauge USP	gauge metric	Länge / length (m)	Farbe / colour	Best.-Nr. / code no.	Packungsinhalt / box content (Stück / pieces)
Spezialsortiment Handchirurgie <i>Special combinations for Hand Surgery</i>						
DSM 11 ▽ 	PDO RESORBA™	6-0	0.7	0,45	violett / violet	PN2151 ¹⁾ 24
	MOPYLEN®	6-0	0.7	0,45	blau / blue	7152 36
DSM 13 ▽ 	PDO RESORBA™	5-0	1	0,45	violett / violet	PN2154 ¹⁾ 24
	PDO RESORBA™	4-0	1.5	0,45	violett / violet	PN2155 ¹⁾ 24
	MOPYLEN®	6-0	0.7	0,45	blau / blue	7155 36
	MOPYLEN®	5-0	1	0,45	blau / blue	7156 36
	SUPOLENE	5-0	1	0,45	grün / green	9152 36
	SUPOLENE	4-0	1.5	0,45	grün / green	9153 36
DSM 16 ▽ 	MOPYLEN®	4-0	1.5	0,45	blau / blue	71511 36
DSM 18 ▽ 	PDO RESORBA™	4-0	1.5	0,45	violett / violet	PN21510 ¹⁾ 24
	MOPYLEN®	4-0	1.5	0,45	blau / blue	71513 36
	MOPYLEN®	3-0	2	0,45	blau / blue	71514 36
DS 18 ▼ 	PDO RESORBA™	4-0	1.5	0,30	violett / violet	PN2149 ¹⁾ 24
	MOPYLEN®	4-0	1.5	0,30	blau / blue	71447 36
	MOPYLEN®	3-0	2	0,30	blau / blue	71448 36
DR 18 ● 	PDO RESORBA™	4-0	1.5	0,30	violett / violet	PN2079 ¹⁾ 24
	PDO RESORBA™	3-0	2	0,30	violett / violet	PN2078 ¹⁾ 24
	MOPYLEN®	4-0	1.5	0,30	blau / blue	70734 36
	MOPYLEN®	3-0	2	0,30	blau / blue	70733 36
	SUPRAMID	4-0	1.5	0,50	weiß / white	6070 36
DRTM 12 ⊙ 	PDO RESORBA™	5-0	1	0,70	violett / violet	PN2256 ¹⁾ 24
	MOPYLEN®	6-0	1	0,75	blau / blue	7258 36
DRT 18 ⊙ 	PDO RESORBA™	4-0	1.5	0,45	violett / violet	PN2081 ¹⁾ 24
	MOPYLEN®	4-0	1.5	0,75	blau / blue	7089 36
	SUPRAMID	4-0	1.5	0,50	weiß / white	6080 36
GR 20 ● 	PDO RESORBA™	4-0	1.5	0,35	violett / violet	PN2091 ¹⁾ 24

¹⁾ Produkt hergestellt durch / product manufactured by:

 **Healthium Medtech Private Limited** · No. 472/D, 13th Cross, 4th Phase
Peenya Industrial Area, Bangalore 560 058, India
Mfg. Lic. No.: MFG/MD/2019/000139 · Email: care@healthiummedtech.com

Chirurgische Federöhrnadeln

Spring-eyed needles



Gehärteter Edelstahl:

- hohe Biegefestigkeit
- garantiert rostfrei

Optimiertes Federöhrdesign:

- sicherer Fadenhalt
- vermindert das Risiko einer Verletzung der Fadenoberfläche
- schnelles und leichtes Einfädeln durch optimale Elastizität des Federöhrs

Präzisionsschliff:

- Reduzierung des Wundtraumas durch scharfen Kantenschliff
- hohe Penetrationsfähigkeit

Tempered stainless steel:

- *high bending resistance*
- *guaranteed rustproof*

Optimised spring eye design:











- *secure hold for the suture*
- *reduces the risk of damage to the suture's surface*
- *fast and easy suture insertion due to the optimal elasticity of the spring eye*

Precision honing:

- *sharply honed cutting edge reduces tissue trauma*
- *excellent penetration ability*



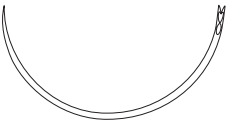



Chirurgische Federöhrnadeln – unsteril

Spring-eyed needles – non sterile

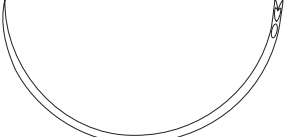
Nadel / needle	Nadelbezeichnung needle type	Euro-Code Europ. code	Best.-Nr. code no.	Inhalt Blister blister content
H (318) = 5/8-Kreis Rundkörper, standard <i>H (318) = 5/8 circle, taper point, standard</i>				
FR 42 ● 	H 318 / 2 F	R 42 (130)	OEFR42	3
G (312) = 1/2-Kreis Rundkörper, standard <i>G (312) = 1/2 circle, taper point, standard</i>				
HR 20 ● 	G 312 /15	HR 20(70)	OEHR20	6
HR 23 ● 	G 312 /14	HR 23(80)	OEHR23	6
HR 26 ● 	G 312 /13	HR 26(80)	OEHR26	6
HR 30 ● 	G 312 /12	HR 30(80)	OEHR30	6
HR 34 ● 	G 312 /11	HR 34(90)	OEHR34	6
HR 38 ● 	G 312 /10	HR 38(90)	OEHR38	6
HR 42 ● 	G 312 /9	HR 42(100)	OEHR42	6
HR 46 ● 	G 312 /8	HR 46(100)	OEHR46	6
HR 50 ● 	G 312 /7	HR 50(110)	OEHR50	6

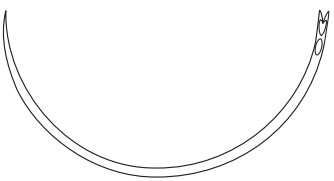

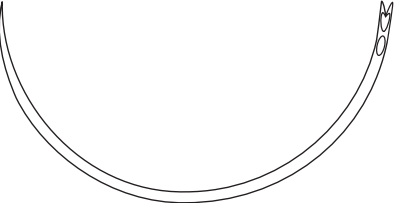





Chirurgische Federöhrnadeln – unsteril

Spring-eyed needles – non sterile

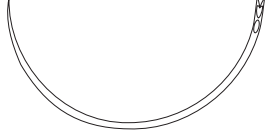
Nadel / needle	Nadelbezeichnung needle type	Euro-Code Europ. code	Best.-Nr. code no.	Inhalt Blister blister content	
HR 54 ●		G 312 /6	HR 54(110)	OEHR54	3
HR 58 ●		G 312 /5	HR 58(120)	OEHR58	3
HR 63 ●		G 312 /4	HR 63(130)	OEHR63	3
HR 68 ●		G 312 /3	HR 68(130)	OEHR68	3
HR 73 ●		G 312 /2	HR 73(140)	OEHR73	3
HR 80 ●		G 312 /1	HR 80(140)	OEHR80	3
HR 86 ●		G 312 /0	HR 86(160)	OEHR86	3









Chirurgische Federöhrnadeln – unsteril

Spring-eyed needles – non sterile

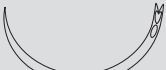
Nadel / needle	Nadelbezeichnung needle type	Euro-Code Europ. code	Best.-Nr. code no.	Inhalt Blister blister content
E (320) = 1/2-Kreis Rundkörper, fein <i>E (320) = 1/2 circle, taper point, thin</i>				
HR 18 F ● 	E 320/6	HR 18(60)	OEHR18F	6
HR 20 F ● 	E 320/5	HR 20(60)	OEHR20F	6
HR 23 F ● 	E 320/4	HR 23(70)	OEHR23F	6
HR 54 F ● 	E 320/0	HR 54(100)	OEHR54F	3
HR 63 F ● 	E 320/00	HR 63(110)	OEHR63F	3
Pb (332) = 1/2-Kreis Rundkörper, extra fein <i>Pb (332) = 1/2 circle, taper point, extra thin</i>				
HR 24 FF ● 	Pb 332/5	HR 24(60)	OEHR24FF	6
HR 30 FF ● 	Pb 332/4	HR 30(60)	OEHR30FF	6
HR 36 FF ● 	Pb 332/3	HR 36(60)	OEHR36FF	6
HR 42 FF ● 	Pb 332/2	HR 42(70)	OEHR42FF	6











Chirurgische Federöhrnadeln – unsteril

Spring-eyed needles – non sterile

Nadel / needle	Nadelbezeichnung needle type	Euro-Code Europ. code	Best.-Nr. code no.	Inhalt Blister blister content
GaR (314) = 1/2-Kreis Rundkörper, stark <i>GaR (314) = 1/2 circle, taper point, strong diameter</i>				
HR 23 S ● 	GaR 314 /8	HR 23(100)	OEHR23S	6
HR 27 S ● 	GaR 314 /7	HR 27(100)	OEHR27S	6
HR 32 S ● 	GaR 314 /6	HR 32(110)	OEHR32S	6
HR 38 S ● 	GaR 314 /5	HR 38(130)	OEHR38S	6
HR 46 S ● 	GaR 314 /4	HR 46(140)	OEHR46S	6
HR 54 S ● 	GaR 314 /3	HR 54(140)	OEHR54S	3
HR 60 S ● 	GaR 314 /2	HR 60(160)	OEHR60S	3
Asymptotische schneidende Rundkörper <i>asymptotic, taper cutting</i>				
ART 13 ● 	-	ART 13(60)	OEART13	6







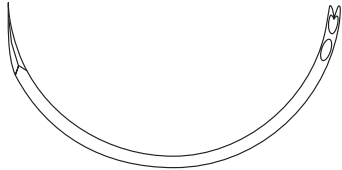

Chirurgische Federöhrnadeln – unsteril

Spring-eyed needles – non sterile

Nadel / needle		Nadelbezeichnung needle type	Euro-Code Europ. code	Best.-Nr. code no.	Inhalt Blister blister content
G (412) = 1/2-Kreis schneidende Rundkörper (Diamond Spitze) G (412) = 1/2 circle, taper cutting					
HRT 20 ▼		G 412 /15	HRT 20(70)	OEHRT20	6
HRT 23 ▼		G 412 /14	HRT 23(80)	OEHRT23	6
HRT 26 ▼		G 412 /13	HRT 26(80)	OEHRT26	6
HRT 30 ▼		G 412 /12	HRT 30(80)	OEHRT30	6
HRT 34 ▼		G 412 /11	HRT 34(90)	OEHRT34	6
HRT 38 ▼		G 412 /10	HRT 38(90)	OEHRT38	6
HRT 42 ▼		G 412 /9	HRT 42(100)	OEHRT42	6
HRT 46 ▼		G 412 /8	HRT 46(100)	OEHRT46	6
HRT 50 ▼		G 412 /7	HRT 50(110)	OEHRT50	6
HRT 54 ▼		G 412 /6	HRT 54(110)	OEHRT54	3
HRT 58 ▼		G 412 /5	HRT 58(120)	OEHRT58	3







Chirurgische Federöhrnadeln – unsteril

Spring-eyed needles – non sterile

Nadel / needle	Nadelbezeichnung needle type	Euro-Code Europ. code	Best.-Nr. code no.	Inhalt Blister blister content	
HRT 63 ▼		G 412 /4	HRT 63(130)	OEHRT63	3
HRT 68 ▼		G 412 /3	HRT 68(130)	OEHRT68	3
Gerade schneidende Rundkörper (Diamond Spitze) <i>straight, taper cutting</i>					
GRT 15 ▼		-	GRT 15(80)	OEGRT15	20
GT (212) = 1/2-Kreis außen schneidend, standard <i>GT (212) = 1/2 circle, reverse cutting, standard</i>					
HS 23 ▼		GT 212 /14	HS 23(80)	OEHS23	6
HS 26 ▼		GT 212 /13	HS 26(80)	OEHS26	6
HS 30 ▼		GT 212 /12	HS 30(80)	OEHS30	6
HS 34 ▼		GT 212 /11	HS 34(90)	OEHS34	6
HS 38 ▼		GT 212 /10	HS 38(90)	OEHS38	6
HS 42 ▼		GT 212 /9	HS 42(100)	OEHS42	6



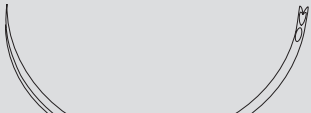

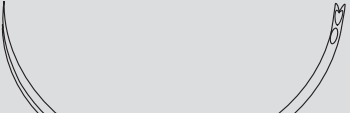





Chirurgische Federöhrnadeln – unsteril

Spring-eyed needles – non sterile

Nadel / needle	Nadelbezeichnung needle type	Euro-Code Europ. code	Best.-Nr. code no.	Inhalt Blister blister content
HS 46 ▼ 	GT 212 /8	HS 46(100)	OEHS46	6
HS 50 ▼ 	GT 212 /7	HS 50(110)	OEHS50	6
HS 54 ▼ 	GT 212 /6	HS 54(110)	OEHS54	3
HS 58 ▼ 	GT 212 /5	HS 58(120)	OEHS58	3
HS 63 ▼ 	GT 212 /4	HS 63(130)	OEHS63	3
HS 68 ▼ 	GT 212 /3	HS 68(130)	OEHS68	3
HS 73 ▼ 	GT 212 /2	HS 73(140)	OEHS73	3









Chirurgische Federöhrnadeln – unsteril

Spring-eyed needles – non sterile

Nadel / needle		Nadelbezeichnung needle type	Euro-Code Europ. code	Best.-Nr. code no.	Inhalt Blister blister content
GaT (214) = 1/2-Kreis außen schneidend, stark <i>GaT (214) = 1/2 circle, reverse cutting, strong diameter</i>					
HS 18 S ▼		GaT 214 /9	HS 18(90)	OEHS18S	6
HS 23 S ▼		GaT 214 /8	HS 23(100)	OEHS23S	6
HS 27 S ▼		GaT 214 /7	HS 27(100)	OEHS27S	6
HS 32 S ▼		GaT 214 /6	HS 32(110)	OEHS32S	6
HS 38 S ▼		GaT 214 /5	HS 38(130)	OEHS38S	6
HS 46 S ▼		GaT 214 /4	HS 46(140)	OEHS46S	6
HS 54 S ▼		GaT 214 /3	HS 54(140)	OEHS54S	3
BT (204) = 3/8-Kreis außen schneidend, standard <i>BT (204) = 3/8 circle, reverse cutting, standard</i>					
DS 18 ▼		BT 204 /16	DS 18(70)	OEDS18	6
DS 20 ▼		BT 204 /15	DS 20(70)	OEDS20	6
DS 23 ▼		BT 204 /14	DS 23(80)	OEDS23	6

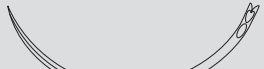

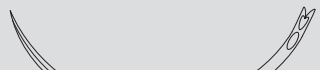

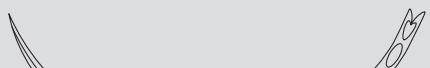
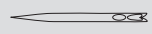





Chirurgische Federöhrnadeln – unsteril

Spring-eyed needles – non sterile

Nadel / needle		Nadelbezeichnung needle type	Euro-Code Europ. code	Best.-Nr. code no.	Inhalt Blister blister content
DS 26 ▼		BT 204 /13	DS 26(80)	OEDS26	6
DS 30 ▼		BT 204 /12	DS 30(80)	OEDS30	6
DS 34 ▼		BT 204 /11	DS 34(90)	OEDS34	6
DS 38 ▼		BT 204 /10	DS 38(90)	OEDS38	6
DS 42 ▼		BT 204 /9	DS 42(100)	OEDS42	6
DS 46 ▼		BT 204 /8	DS 46(100)	OEDS46	3
DS 50 ▼		BT 204 /7	DS 50(110)	OEDS50	3
DS 54 ▼		BT 204 /6	DS 54(110)	OEDS54	3
DS 70 ▼		BT 204 /3	DS 70(130)	OEDS70	3
Gerade schneidend, standard (Keith) <i>straight, cutting, standard (Keith)</i>					
GS 20 ▼		-	GS 20(80)	OEGS20	20

Chirurgische Federöhrnadeln – steril

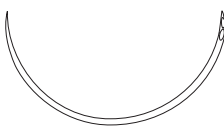



Spring-eyed needles – sterile

Nadel / needle	Nadelbezeichnung needle type	Euro-Code Europ. code	Best.-Nr. code no.	Packungsinhalt / box content (Stück / pieces)
H (318) = 5/8-Kreis Rundkörper, standard <i>H (318) = 5/8 circle, taper point, standard</i>				
FR 42 ● 	H 318 / 2	FR 42 (130)	OESFR42	48
G (312) = 1/2-Kreis Rundkörper, standard <i>G (312) = 1/2 circle, taper point, standard</i>				
HR 20 ● 	G 312 /15	HR 20(70)	OESHR20*	48
HR 23 ● 	G 312 /14	HR 23(80)	OESHR23	48
HR 26 ● 	G 312 /13	HR 26(80)	OESHR26	48
HR 30 ● 	G 312 /12	HR 30(80)	OESHR30	48
HR 34 ● 	G 312 /11	HR 34(90)	OESHR34	48
HR 38 ● 	G 312 /10	HR 38(90)	OESHR38	48
HR 42 ● 	G 312 /9	HR 42(100)	OESHR42	48
HR 46 ● 	G 312 /8	HR 46(100)	OESHR46	48
HR 50 ● 	G 312 /7	HR 50(110)	OESHR50	48

*eventuell mit verlängerter Lieferzeit verbunden / possibly associated with an extended delivery time

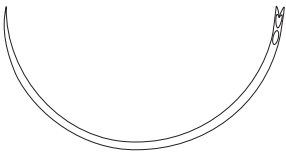

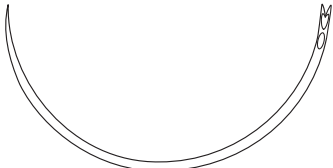



Chirurgische Federöhrnadeln – steril

Spring-eyed needles – sterile

Nadel / needle	Nadelbezeichnung needle type	Euro-Code Europ. code	Best.-Nr. code no.	Packungsinhalt / box content (Stück / pieces)
HR 54 ● 	G 312 /6	HR 54(110)	OESHR54	48
HR 58 ● 	G 312 /5	HR 58(120)	OESHR58	48
HR 63 ● 	G 312 /4	HR 63(130)	OESHR63	48
HR 68 ● 	G 312 /3	HR 68(130)	OESHR68	48
HR 73 ● 	G 312 /2	HR 73(140)	OESHR73	48

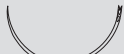
Chirurgische Federöhrnadeln – steril

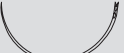

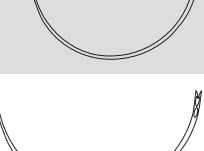







Spring-eyed needles – sterile

Nadel / needle	Nadelbezeichnung needle type	Euro-Code Europ. code	Best.-Nr. code no.	Packungsinhalt / box content (Stück / pieces)
E (320) = 1/2-Kreis Rundkörper, fein <i>E (320) = 1/2 circle, taper point, thin</i>				
HR 18 F ● 	E 320 /6	HR 18(60)	OESHR18F	48
HR 20 F ● 	E 320 /5	HR 20(60)	OESHR20F	48
HR 23 F ● 	E 320 /4	HR 23(70)	OESHR23F	48
HR 54 F ● 	E 320 /0 HR	54(100)	OESHR54F	48
HR 63 F ● 	E 320 /00	HR 63(110)	OESHR63F*	48
Pb (332) = 1/2-Kreis Rundkörper, extra fein <i>Pb (332) = 1/2 circle, taper point, extra thin</i>				
HR 24 FF ● 	Pb 332 /5	HR 24(60)	OESHR24FF	48
HR 30 FF ● 	Pb 332 /4	HR 30(60)	OESHR30FF	48
HR 36 FF ● 	Pb 332 /3	HR 36(60)	OESHR36FF	48
HR 42 FF ● 	Pb 332 /2	HR 42(70)	OESHR42FF	48

*eventuell mit verlängerter Lieferzeit verbunden / possibly associated with an extended delivery time

Chirurgische Federöhrnadeln – steril









Spring-eyed needles – sterile

Nadel / needle		Nadelbezeichnung needle type	Euro-Code Europ. code	Best.-Nr. code no.	Packungsinhalt / box content (Stück / pieces)
GaR (314) = 1/2-Kreis Rundkörper, stark <i>GaR (314) = 1/2 circle, taper point, strong diameter</i>					
HR 23 S ●		GaR 314 /8	HR 23(100)	OESHR23S	48
HR 27 S ●		GaR 314 /7	HR 27(100)	OESHR27S	48
HR 32 S ●		GaR 314 /6	HR 32(110)	OESHR32S	48
HR 38 S ●		GaR 314 /5	HR 38(130)	OESHR38S	48
HR 46 S ●		GaR 314 /4	HR 46(140)	OESHR46S	48
HR 54 S ●		GaR 314 /3	HR 54(140)	OESHR54S	48
HR 60 S ●		GaR 314 /2	HR 60(160)	OESHR60S	48
G (412) = 1/2-Kreis schneidende Rundkörper (Diamond Spitze) <i>G (412) = 1/2 circle, taper cutting</i>					
HRT 20 ▼		G 412 /15	HRT 20(70)	OESHRT20	48
HRT 23 ▼		G 412 /14	HRT 23(80)	OESHRT23	48
HRT 26 ▼		G 412 /13	HRT 26(80)	OESHRT26*	48
HRT 30 ▼		G 412 /12	HRT 30(80)	OESHRT30	48

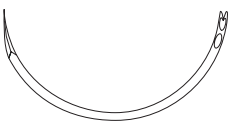
*eventuell mit verlängerter Lieferzeit verbunden / possibly associated with an extended delivery time

Chirurgische Federöhrnadeln – steril

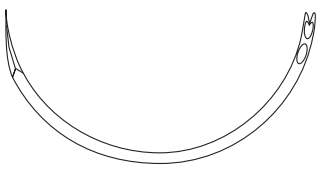









Spring-eyed needles – sterile

Nadel / needle		Nadelbezeichnung needle type	Euro-Code Europ. code	Best.-Nr. code no.	Packungsinhalt / box content (Stück / pieces)
HRT 34 ▼		G 412 /11	HRT 34(90)	OESHRT34	48
HRT 38 ▼		G 412 /10	HRT 38(90)	OESHRT38*	48
HRT 42 ▼		G 412 /9	HRT 42(100)	OESHRT42*	48
HRT 46 ▼		G 412 /8	HRT 46(100)	OESHRT46	48
HRT 50 ▼		G 412 /7	HRT 50(110)	OESHRT50	48
HRT 54 ▼		G 412 /6	HRT 54(110)	OESHRT54*	48
HRT 58 ▼		G 412 /5	HRT 58(120)	OESHRT58	48
HRT 63 ▼		G 412 /4	HRT 63(130)	OESHRT63	48
HRT 68 ▼		G 412 /3	HRT 68(130)	OESHRT68	48

*eventuell mit verlängerter Lieferzeit verbunden / possibly associated with an extended delivery time

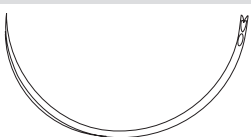
Chirurgische Federöhrnadeln – steril









Spring-eyed needles – sterile

Nadel / needle	Nadelbezeichnung needle type	Euro-Code Europ. code	Best.-Nr. code no.	Packungsinhalt / box content (Stück / pieces)
GT (212) = 1/2-Kreis außen schneidend, standard GT (212) = 1/2 circle, reverse cutting, standard				
HS 23 ▼ 	GT 212 /14	HS 23(80)	OESHS23*	48
HS 26 ▼ 	GT 212 /13	HS 26(80)	OESHS26*	48
HS 30 ▼ 	GT 212 /12	HS 30(80)	OESHS30	48
HS 34 ▼ 	GT 212 /11	HS 34(90)	OESHS34	48
HS 38 ▼ 	GT 212 /10	HS 38(90)	OESHS38	48
HS 42 ▼ 	GT 212 /9	HS 42(100)	OESHS42	48
HS 46 ▼ 	GT 212 /8	HS 46(100)	OESHS46	48
HS 50 ▼ 	GT 212 /7	HS 50(110)	OESHS50	48
HS 54 ▼ 	GT 212 /6	HS 54(110)	OESHS54	48
HS 58 ▼ 	GT 212 /5	HS 58(120)	OESHS58	48
HS 63 ▼ 	GT 212 /4	HS 63(130)	OESHS63	48

*eventuell mit verlängerter Lieferzeit verbunden / possibly associated with an extended delivery time











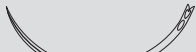

Chirurgische Federöhrnadeln – steril

Spring-eyed needles – sterile

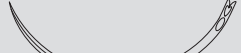
Nadel / needle	Nadelbezeichnung needle type	Euro-Code Europ. code	Best.-Nr. code no.	Packungsinhalt / box content (Stück / pieces)
HS 68 	GT 212 /3	HS 68(130)	OESHS68	48
HS 73 	GT 212 /2	HS 73(140)	OESHS73	48
GaT (214) = 1/2-Kreis außen schneidend, stark <i>GaT (214) = 1/2 circle, reverse cutting, strong diameter</i>				
HS 18 S 	GaT 214 /9	HS 18(90)	OESHS18S	48
HS 23 S 	GaT 214 /8	HS 23(100)	OESHS23S	48
HS 27 S 	GaT 214 /7	HS 27(100)	OESHS27S	48
HS 32 S 	GaT 214 /6	HS 32(110)	OESHS32S	48
HS 38 S 	GaT 214 /5	HS 38(130)	OESHS38S	48
HS 46 S 	GaT 214 /4	HS 46(140)	OESHS46S	48
HS 54 S 	GaT 214 /3	HS 54(140)	OESHS54S	48

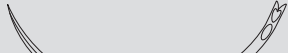
Chirurgische Federöhrnadeln – steril

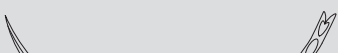
Spring-eyed needles – sterile

Nadel / needle	Nadelbezeichnung needle type	Euro-Code Europ. code	Best.-Nr. code no.	Packungsinhalt / box content (Stück / pieces)
BT (204) = 3/8-Kreis außen schneidend, standard <i>BT (204) = 3/8 circle, reverse cutting, standard</i>				
DS 18 ▼ 	BT 204 /16	DS 18(70)	OESDS18	48
DS 20 ▼ 	BT 204 /15	DS 20(70)	OESDS20	48
DS 23 ▼ 	BT 204 /14	DS 23(80)	OESDS23	48
DS 26 ▼ 	BT 204 /13	DS 26(80)	OESDS26	48
DS 30 ▼ 	BT 204 /12	DS 30(80)	OESDS30	48
DS 34 ▼ 	BT 204 /11	DS 34(90)	OESDS34*	48
DS 38 ▼ 	BT 204 /10	DS 38(90)	OESDS38	48
DS 42 ▼ 	BT 204 /9	DS 42(100)	OESDS42*	48
DS 46 ▼ 	BT 204 /8	DS 46(100)	OESDS46	48
DS 50 ▼ 	BT 204 /7	DS 50(110)	OESDS50	48
DS 54 ▼ 	BT 204 /6	DS 54(110)	OESDS54	48
DS 70 ▼ 	BT 204 /3	DS 70(130)	OESDS70	48

*eventuell mit verlängerter Lieferzeit verbunden / possibly associated with an extended delivery time



P1301 2021-02

RESORBA Medical GmbH, Am Flachmoor 16, 90475 Nürnberg, Germany
Tel: +49 9128 / 91 15 0 Fax: +49 9128 / 91 15 91 Email: infomail@resorba.com
www.resorba.com

