



# AESCULAP® POWER SYSTEMS

KATALOG 2020

ELAN® 4 und Acculan® 4



# INHALT

---

## ELAN® 4

- ELAN® 4 electro
  - ELAN® 4 air
  - ELAN® 4 Zubehör
- 

## Acculan® 4

- Acculan® 4 & Acculan® 4 Kleine Bohrmaschine
  - Acculan® 4 Zubehör
- 

## AUFBEREITUNG

- Sterilit® Power Systems
  - Maschinelle Aufbereitung
- 

## SONSTIGES

- Übersicht Werkzeuganschlüsse
  - Zeichenerklärung
  - Index
-



# AESCULAP® ELAN® 4

PRÄZISE, LEISTUNGSSTARK, INTUITIV

ELAN® 4

ELAN® 4 ist die aktuelle Generation elektrischer und pneumatischer Mikromotoren für die Neuro- und Wirbelsäulenchirurgie. Das technische Konzept berücksichtigt nicht nur die Anforderungen des Chirurgen, sondern aller in die Prozesse eingebundenen Bereiche.

- Laufruhiges und leistungsstarkes Highspeed-System – durch Entfall des Winkelgetriebes direkte Drehzahlübertragung
- Einfache Handhabung – nur Plug and Play-Kupplungen, Einheitsfräserlänge
- Selbsterklärend – Bedienelemente gold gekennzeichnet
- Validiertes Aufbereitungsverfahren – auch für die Innenreinigung der Anwendungsteile



# AESCLAP® ELAN® 4

ELAN® 4 electro

ELEKTRISCHES HIGHSPEED-SYSTEM



## ELAN® 4 electro BASISKOMPONENTEN

### GA800

ELAN® 4 electro **STEUEREINHEIT**  
mit Spülpumpe; Touchscreen;  
ohne Netzkabel  
Fördermenge 0 - 65 ml/min  
100 - 240 V AC; 50 / 60 Hz;  
330 x 330 x 200 mm; 9.500 g  
enthaltene Zubehör:  
GD412804 Flaschenhalter

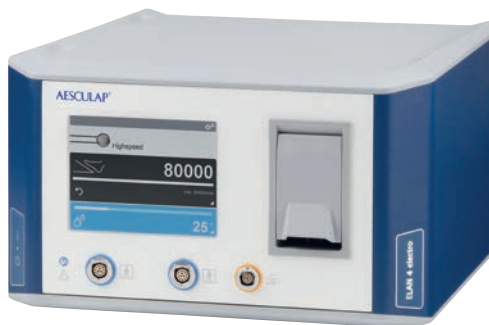

### GA808

ELAN® 4 electro **FUSSSTEUERUNG**  
Schutzklasse IPx8, Anästhesiemittel-  
prüfung Klasse AP  
↗ ↘; 5,0 m;  
245 x 144 x 76 mm; 2.240 g



### GA810

ELAN® 4 electro **FUNKFUSSSCHALTER**  
zur Verwendung mit ELAN® 4 electro  
Anwendungsteilen  
↗ ↘; 271 x 266 x 85 mm; 3.800 g  
Software V3.00 der Steuereinheit  
notwendig



### GA806

**GB073R**

ELAN® 4 electro **MOTORKABEL**  
zur Verwendung mit ELAN® 4 electro  
Anwendungsteilen  
↗ ↘; 4,0 m; 270 g  
enthaltene Zubehör:  
GB600860 Sterilit® Sprühadapter



# AESCULAP® ELAN® 4

## ELAN® 4 electro

### BASISKOMPONENTEN, TREPANATIONSMOTOR UND LOWSPEED MOTOR

**GA804**

**GB073R**

#### ELAN® 4 electro MOTORKABEL MIT HANDHEBEL

zur Verwendung mit ELAN® 4 electro Anwendungsteilen

4,0 m; 370 g

enthaltenes Zubehör:  
GB600860 Sterilit® Sprühadapter



**GA805**

**GB073R**

#### ELAN® 4 electro MOTORKABEL MIT HANDSTEUERUNG

zur Verwendung mit ELAN® 4 electro Anwendungsteilen

4,0 m; 370 g

enthaltenes Zubehör:  
GB600860 Sterilit® Sprühadapter



**GA822**

**GB076R**

#### ELAN® 4 electro TREPANATIONSMOTOR

zur Verwendung mit Schädeltrepanen mit Hudson-Schaft

180 W; 0 - 1.200 1/min;  
250 Ncm; 166 x 35 mm; 410 g

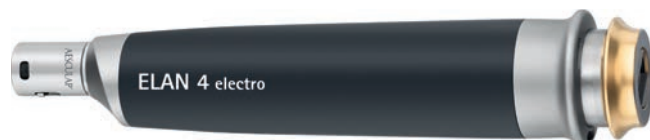

**GA824**

**GB077R**

#### ELAN® 4 electro LOWSPEED MOTOR

mit Intra Kupplung

180 W; 0 - 40.000\* 1/min;  
10 Ncm; 123 x 23 mm; 150 g

\* Software V3.00 der Steuereinheit notwendig.

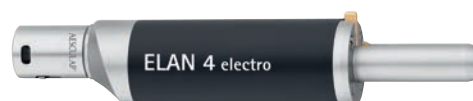





# ELAN® 4 electro KRANIOTOM & MULTIFUNKTIONSHANDSTÜCK

**GA849**

**GB085R**

ELAN® 4 electro KRANIOTOM- UND MULTIFUNKTIONSHANDSTÜCK

Kennzeichnung 2-Ringe;  
zur Verwendung mit Duraschutz  
und Haltehülse GB941R - GB947R;  
Sprühdüse GA259SU (separat zu  
bestellen)

140 W;  0 - 80.000 1/min;  
2,2 Ncm; 156 x 17 mm;  121 g



**GB941R**

**GB719R**

ELAN® 4 DURASCHUTZ PÄDIATRISCH  
feststehend; Kennzeichnung 1 Punkt



**GB942R**

**GB719R**

ELAN® 4 DURASCHUTZ STANDARD  
feststehend; Kennzeichnung 2 Punkte

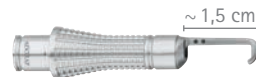

**GB943R**

**GB719R**

ELAN® 4 DURASCHUTZ LANG  
feststehend; Kennzeichnung 3 Punkte



**GB945R**

**GB719R**

ELAN® 4 HALTEHÜLSE

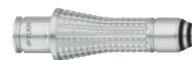

**GB947R**

**GB719R**

ELAN® 4 DURASCHUTZ STANDARD  
drehbar; Kennzeichnung 2 Punkte



# AESCULAP® ELAN® 4

ELAN® 4 electro

HIGHSPEED-HANDSTÜCKE 1-RING

**GA861**

**GB083R**

ELAN® 4 electro 1-RING HANDSTÜCK  
L4

Kennzeichnung 1-Ring;  
Sprühdüse GA261SU  
(separat zu bestellen)

140 W; ↗ ↘; 0 - 80.000 1/min;  
2,2 Ncm; 152 x 16 mm; ⚖ 80 g



**GA862**

**GB083R**

ELAN® 4 electro 1-RING HANDSTÜCK  
L7

Kennzeichnung 1-Ring;  
Sprühdüse GA262SU  
(separat zu bestellen)

140 W; ↗ ↘; 0 - 80.000 1/min;  
2,2 Ncm; 177 x 16 mm; ⚖ 83 g



**GA863**

**GB083R**

ELAN® 4 electro 1-RING HANDSTÜCK  
L10

Kennzeichnung 1-Ring;  
Sprühdüse GA263SU  
(separat zu bestellen)

140 W; ↗ ↘; 0 - 80.000 1/min;  
2,2 Ncm; 206 x 16 mm; ⚖ 87 g



**GA864**

**GB083R**

ELAN® 4 electro 1-RING HANDSTÜCK  
L13

Kennzeichnung 1-Ring;  
Sprühdüse GA264SU  
(separat zu bestellen)

140 W; ↗ ↘; 0 - 80.000 1/min;  
2,2 Ncm; 237 x 16 mm; ⚖ 91 g

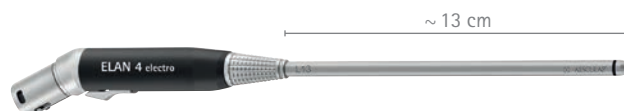

## ELAN® 4 electro HIGHSPEED-HANDSTÜCKE 2-RING

**GA865****GB083R****ELAN® 4 electro 2-RING HANDSTÜCK  
L7**

Kennzeichnung 2-Ringe;  
Sprühdüse GA265SU  
(separat zu bestellen)

140 W; ↗ ↘; 0-80.000 1/min;  
2,2 Ncm; 176 x 16 mm; 📖 89 g

**GA866****GB083R****ELAN® 4 electro 2-RING HANDSTÜCK  
L10**

Kennzeichnung 2-Ringe;  
Sprühdüse GA266SU  
(separat zu bestellen)

140 W; ↗ ↘; 0-80.000 1/min;  
2,2 Ncm; 206 x 16 mm; 📖 95 g

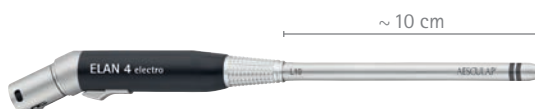
**GA867****GB083R****ELAN® 4 electro 2-RING HANDSTÜCK  
L13**

Kennzeichnung 2-Ringe;  
Sprühdüse GA267SU  
(separat zu bestellen)

140 W; ↗ ↘; 0-80.000 1/min;  
2,2 Ncm; 236 x 16 mm; 📖 100 g

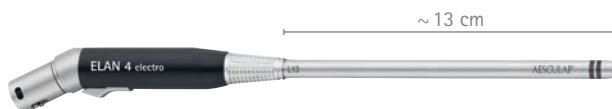
**GA868****GB083R****ELAN® 4 electro 2-RING HANDSTÜCK  
L17**

Kennzeichnung 2-Ringe;  
Sprühdüse GA268SU  
(separat zu bestellen)

140 W; ↗ ↘; 0-80.000 1/min;  
2,2 Ncm; 276 x 16 mm; 📖 108 g

**GA869****GB083R****ELAN® 4 electro 2-RING HANDSTÜCK  
L22**

Kennzeichnung 2-Ringe;  
Sprühdüse GA269SU  
(separat zu bestellen)

140 W; ↗ ↘; 0-80.000 1/min;  
2,2 Ncm; 326 x 16 mm; 📖 118 g



# AESCULAP® ELAN® 4

ELAN® 4 electro  
MIS HANDSTÜCK



**GA860****GB084R****ELAN® 4 electro MIS HANDSTÜCK**

140 W; ↗ ↘; 0 - 80.000 1/min;  
2,2 Ncm; 150 x 18 mm; 76 g  
zur Verwendung mit Schäften  
GB920R - GB927R

**GB920R****GB723R****ELAN® 4 MIS HANDSTÜCKSCHAFT  
L10 GERADE**

Sprühdüse GB796SU  
(separat zu bestellen)

**GB921R****GB723R****ELAN® 4 MIS HANDSTÜCKSCHAFT  
L10 GEBOGEN**

Sprühdüse GB796SU  
(separat zu bestellen)

**GB922R****GB723R****ELAN® 4 MIS HANDSTÜCKSCHAFT  
L10 STARK GEBOGEN**

Sprühdüse GB796SU  
(separat zu bestellen)

**GB925R****GB723R****ELAN® 4 MIS HANDSTÜCKSCHAFT  
L13 GERADE**

Sprühdüse GB797SU  
(separat zu bestellen)

**GB926R****GB723R****ELAN® 4 MIS HANDSTÜCKSCHAFT  
L13 GEBOGEN**

Sprühdüse GB797SU  
(separat zu bestellen)

**GB927R****GB723R****ELAN® 4 MIS HANDSTÜCKSCHAFT  
L13 STARK GEBOGEN**

Sprühdüse GB797SU  
(separat zu bestellen)



# AESCLAP<sup>®</sup> ELAN<sup>®</sup> 4

ELAN<sup>®</sup> 4 electro

SÄGEN



**GA836****GB086R****ELAN® 4 electro MIKRO-SAGITTALSÄGE**

Sprühdüse GA258SU  
(separat zu bestellen)

180 W; 0 - 20.000 1/min; 161 x 23 mm;  
∠ 7°; 190 g

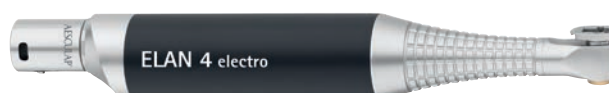
**GA837****GB087R****ELAN® 4 electro MIKRO-STICHSÄGE**

Sprühdüse GA258SU  
(separat zu bestellen)

180 W; 0 - 20.000 1/min; 184 x 23 mm;  
∅ 1,8 mm; 198 g

**GA831****GB088R****ELAN® 4 electro SAGITTALSÄGE**

Sprühdüse GA258SU  
(separat zu bestellen)

180 W; 0 - 20.000 1/min; 129 x 23 mm;  
∠ 4,5°; 220 g

**GA832****GB087R****ELAN® 4 electro STICHSÄGE**

Sprühdüse GA258SU  
(separat zu bestellen)

180 W; 0 - 20.000 1/min; 194 x 23 mm;  
∅ 2,5 mm; 238 g

**GA833****GB088R****ELAN® 4 electro TRANSVERSALSÄGE**

Sprühdüse GA258SU  
(separat zu bestellen)

180 W; ↖ ↗; 0 - 20.000 1/min; 10 Ncm;  
130 x 23 mm; ∠ 10°; 185 g

zur Verwendung mit Transversalsäge-  
geschäften GP580R, GP582R, GP586R,  
GP590R

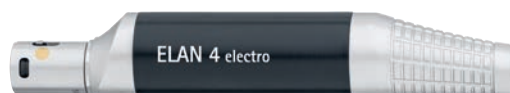

# AESCULAP® ELAN® 4

ELAN® 4 electro

BOHRMASCHINE & AUFSÄTZE

GA844

GB482R

ELAN® 4 electro BOHRMASCHINE

mit Oszillations- und Gewindeschneidmodus

200 W;   3,3 mm;  
130 x 27 x 122 mm;  800 g

enthaltenes Zubehör:

GA344244 Spickdraht Schutzhülse

GA344211 Spüladapter

GB600880 Sprühadapter

Software V3.00 der Steuereinheit  
notwendig.





GB870R

GB716R

MARKRAUMBOHRAUFSATZ

Dreibackenfutter 0,5 - 7,4 mm,  
nicht zur Verwendung mit Acetabulum-  
fräsern geeignet

0 - 320 1/min; 6,5 Nm;  3,2 mm;  
105 x 29 mm;  230 g

enthaltenes Zubehör:

Schlüssel GA031R





GB871R

GB716R

MARKRAUMBOHRAUFSATZ

AO groß, nicht zur Verwendung mit  
Acetabulumfräsern geeignet

0 - 320 1/min; 6,5 Nm;  3,2 mm;  
88 x 29 mm;  170 g





GB872R

GB716R

MARKRAUMBOHRAUFSATZ

Hudson/Zimmer, nicht zur Verwendung  
mit Acetabulumfräsern geeignet

0 - 320 1/min; 6,5 Nm;  3,2 mm;  
86 x 25 mm;  150 g







## ELAN® 4 electro AUFsätze

**GB881R**

**GB716R**

### BOHRAUFSATZ

Dreibackenfutter 0,5 - 7,4 mm

1.250 1/min; 2 Nm;  3,2 mm;  
89 x 29 mm;  163 g

enthaltenes Zubehör:  
Schlüssel GA031R





**GB882R**

**GB716R**

### BOHRAUFSATZ

Dreibackenfutter 0,5 - 4 mm

1.250 1/min; 2 Nm;  3,2 mm;  
76 x 22 mm;  100 g

enthaltenes Zubehör:  
Schlüssel GA062R





**GB884R**

**GB716R**

### BOHRAUFSATZ

AO klein

1.250 1/min; 2 Nm;  2,8 mm;  
60 x 22 mm;  66 g





**GB886R**

**GB716R**

### BOHRAUFSATZ

AESULAP® Sechskant

1.250 1/min; 2 Nm;  3,2 mm;  
57 x 24 mm;  67 g





**GB887R**

**GB716R**

### BOHRAUFSATZ

Dentalschaft

1.250 1/min; 2 Nm;  1,8 mm;  
56 x 22 mm;  50 g



# AESCULAP® ELAN® 4

ELAN® 4 electro

AUFSÄTZE

**GB878R**

**GB716R**

ADAPTER

Synthes 511.300

1.250 1/min; 2 Nm;  
111 x 27 mm; 181 g



**GB894R**

**GB716R**

SPICKDRAHTAUFSATZ

für Spickdrähte von 0,6 - 3,2 mm

1.250 1/min; 3,2 mm;  
92 x 27 x 124 mm; 179 g



**GB891R**

**GB716R**

SAGITTALSÄGEAUFSATZ

für Sägeblätter "L-sagittal" mit einer  
maximalen Nutzlänge von 50 mm

0 - 15.750 1/min; 74 x 33,5 mm;  
4,5°; 179 g



**GB892R**

**GB716R**

STICHSÄGEAUFSATZ



für Stichsägeblätter

0 - 15.750 1/min; 135 x 24,5 mm;  
2,5 mm; 166 g





**GB896R****GB716R****SCHRAUBAUFSATZ**

AO klein

0 - 165 1/min; 12 Nm;  1,7 mm;  
95 x 28 x 129,5 mm;  235 g**GB897R****GB716R****SCHRAUBAUFSATZ**

AESCULAP® Sechskant

0 - 165 1/min; 12 Nm;  1,7 mm;  
95 x 28 x 129,5 mm;  231 g

# AESCULAP® ELAN® 4

ELAN® 4 air

PNEUMATISCHES HIGHSPEED-SYSTEM



## ELAN® 4 air WANDSCHLÄUCHE & ADAPTER

### GA702R

#### ELAN® 4 air WANDSCHLAUCH

zur Verwendung mit ELAN® 4 air  
Wandadaptern GA710R - GA715R

 3,0 m



### GA703R

#### ELAN® 4 air WANDSCHLAUCH

zur Verwendung mit ELAN® 4 air  
Wandadaptern GA710R - GA715R

 5,0 m

### GA710R

#### ELAN® 4 air WANDADAPTER

##### AESCULAP® Dräger

zur Verwendung mit ELAN® 4 air  
Schläuchen GA702, GA703, GA706R,  
GA707R



### GA712R

#### ELAN® 4 air WANDADAPTER

##### Schrader mit Diffusor

zur Verwendung mit ELAN® 4 air  
Schläuchen GA702, GA703, GA706R,  
GA707R



### GA713R

#### ELAN® 4 air WANDADAPTER

##### DIN mit Diffusor

zur Verwendung mit ELAN® 4 air  
Schläuchen GA702, GA703, GA706R,  
GA707R



### GA715R

#### ELAN® 4 air WANDADAPTER

##### Synthes

zur Verwendung mit ELAN® 4 air  
Schläuchen GA702, GA703, GA706R,  
GA707R



# AESCULAP® ELAN® 4

## ELAN® 4 air

### FUSSSTEUERUNG, MOTORSCHLÄUCHE UND TREPANATIONSMOTOR

#### GA708

##### ELAN® 4 air FUSSTEUERUNG

zur Verwendung mit ELAN® 4 air Wandadaptern, GA710R - GA715R; ELAN® 4 air Wandschläuchen GA702R, GA703R; ELAN® 4 air Motorschläuchen GA705R - GA707R



#### GA705R

GB053R

##### ELAN® 4 air MOTORSCHLAUCH

zur Verwendung mit ELAN® 4 air Anwendungsteilen und ELAN® 4 air Fußschalter GA708

3,0 m

enthaltenes Zubehör:  
GB600850 Sterilit® Sprühadapter



#### GA706R

GB053R

##### ELAN® 4 air MOTORSCHLAUCH

mit Handsteuerung; zur Verwendung mit ELAN® 4 air Anwendungsteilen und ELAN® 4 air Wandadaptern GA710R - GA715R

3,0 m

enthaltenes Zubehör:  
GB600850 Sterilit® Sprühadapter



#### GA707R

GB053R

##### ELAN® 4 air MOTORSCHLAUCH

mit Handsteuerung; zur Verwendung mit ELAN® 4 air Anwendungsteilen und ELAN® 4 air Wandadaptern GA710R - GA715R

5,0 m

enthaltenes Zubehör:  
GB600850 Sterilit® Sprühadapter



#### GA722

GB056R

##### ELAN® 4 air TREPANATIONSMOTOR

zur Verwendung mit Schädel-trepanen mit Hudson-Schaft

100 W; 0 - 1.200 1/min; 400 Ncm;  
155 x 35 mm; 427 g

# ELAN® 4 air

## KRANIOTOM & MULTIFUNKTIONSHANDSTÜCK

**GA749**

**GB065R**

ELAN® 4 air KRANIOTOM- UND MULTIFUNKTIONSHANDSTÜCK

Kennzeichnung 2-Ringe; zur Verwendung mit Duraschutz und Haltehülsen GB941R - GB947R; 80 W; 0 - 80.000 1/min; 3,5 Ncm; 128 x 18 mm; 108 g



**GB941R**

**GB719R**

ELAN® 4 DURASCHUTZ PÄDIATRISCH feststehend; Kennzeichnung 1 Punkt

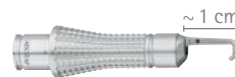

**GB942R**

**GB719R**

ELAN® 4 DURASCHUTZ STANDARD feststehend; Kennzeichnung 2 Punkte

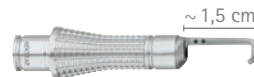

**GB943R**

**GB719R**

ELAN® 4 DURASCHUTZ LANG feststehend; Kennzeichnung 3 Punkte



**GB945R**

**GB719R**

ELAN® 4 HALTEHÜLSE

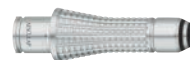

**GB947R**

**GB719R**

ELAN® 4 DURASCHUTZ STANDARD drehbar; Kennzeichnung 2 Punkte



# AESCULAP® ELAN® 4

ELAN® 4 air



HIGHSPEED-HANDSTÜCKE 1-RING

**GA761**

**GB063R**

ELAN® 4 air 1-RING HANDSTÜCK  
L4

Kennzeichnung 1-Ring;

80 W;  0-80.000 1/min; 3,5 Ncm;  
125 x 18 mm;  68 g





**GA762**

**GB063R**

ELAN® 4 air 1-RING HANDSTÜCK  
L7

Kennzeichnung 1-Ring;

80 W;  0-80.000 1/min; 3,5 Ncm;  
150 x 18 mm;  71 g

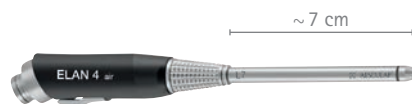



**GA763**

**GB063R**

ELAN® 4 air 1-RING HANDSTÜCK  
L10

Kennzeichnung 1-Ring;

80 W;  0-80.000 1/min; 3,5 Ncm;  
180 x 18 mm;  75 g

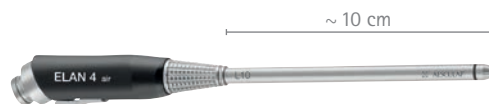



**GA764**

**GB063R**

ELAN® 4 air 1-RING HANDSTÜCK  
L13

Kennzeichnung 1-Ring;

80 W;  0-80.000 1/min; 3,5 Ncm;  
210 x 18 mm;  79 g





## ELAN® 4 air HIGHSPEED HANDSTÜCKE 2-RING

**GA765**

**GB063R**

ELAN® 4 air 2-RING HANDSTÜCK  
L7

Kennzeichnung 2-Ringe;  
80 W;  $\curvearrowright$ ; 0 - 80.000 1/min; 3,5 Ncm;  
150 x 18 mm;  $\text{♁}$  76 g

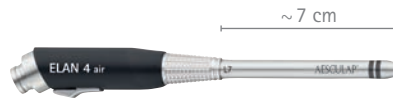

**GA766**

**GB063R**

ELAN® 4 air 2-RING HANDSTÜCK  
L10

Kennzeichnung 2-Ringe;  
80 W;  $\curvearrowright$ ; 0 - 80.000 1/min; 3,5 Ncm;  
180 x 18 mm;  $\text{♁}$  82 g

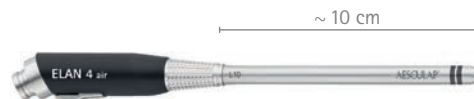

**GA767**

**GB063R**

ELAN® 4 air 2-RING HANDSTÜCK  
L13

Kennzeichnung 2-Ringe;  
80 W;  $\curvearrowright$ ; 0 - 80.000 1/min; 3,5 Ncm;  
210 x 18 mm;  $\text{♁}$  88 g



**GA768**

**GB063R**

ELAN® 4 air 2-RING HANDSTÜCK  
L17

Kennzeichnung 2-Ringe;  
80 W;  $\curvearrowright$ ; 0 - 80.000 1/min; 3,5 Ncm;  
250 x 18 mm;  $\text{♁}$  95 g



**GA769**

**GB063R**

ELAN® 4 air 2-RING HANDSTÜCK  
L22

Kennzeichnung 2-Ringe;  
80 W;  $\curvearrowright$ ; 0 - 80.000 1/min; 3,5 Ncm;  
300 x 18 mm;  $\text{♁}$  105 g





# AESCULAP® ELAN® 4

ELAN® 4 air

MIS HANDSTÜCK & HANDSTÜCKSCHÄFTE



**GA760****GB064R****ELAN® 4 air MIS HANDSTÜCK**

80 W;  0 - 80.000 1/min;  
3,5 Ncm; 150 x 18 mm;  76 g  
zur Verwendung mit Schäften  
GB920R - GB927R

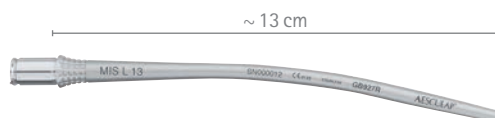
**GB920R****GB723R****ELAN® 4 MIS HANDSTÜCKSCHAFT  
L10 GERADE****GB921R****GB723R****ELAN® 4 MIS HANDSTÜCKSCHAFT  
L10 GEBOGEN****GB922R****GB723R****ELAN® 4 MIS HANDSTÜCKSCHAFT  
L10 STARK GEBOGEN****GB925R****GB723R****ELAN® 4 MIS HANDSTÜCKSCHAFT  
L13 GERADE****GB926R****GB723R****ELAN® 4 MIS HANDSTÜCKSCHAFT  
L13 GEBOGEN****GB927R****GB723R****ELAN® 4 MIS HANDSTÜCKSCHAFT  
L13 STARK GEBOGEN**

# AESCULAP® ELAN® 4

ELAN® 4 air

SÄGEN & LOWSPEED MOTOR



**GA736****GB066R****ELAN® 4 air MIKRO-SAGITTALSÄGE**

60 W; 0-18.000 1/min; 150 x 23 mm;  
 $\sphericalangle$  7°;  $\bar{\bar{m}}$  214 g

**GA737****GB067R****ELAN® 4 air MIKRO-STICHSÄGE**

75 W; 0-21.000 1/min; 167 x 23 mm;  
 $\bar{\bar{m}}$  1,3 mm;  $\bar{\bar{m}}$  215 g

**GA731****GB068R****ELAN® 4 air SAGITTALSÄGE**

75 W; 0-21.000 1/min; 116 x 23 mm;  
 $\sphericalangle$  4,5°;  $\bar{\bar{m}}$  240 g

**GA732****GB067R****ELAN® 4 air STICHSÄGE**

75 W; 0-21.000 1/min; 118 x 23 mm;  
 $\bar{\bar{m}}$  2,5 mm;  $\bar{\bar{m}}$  250 g

**GA733****GB068R****ELAN® 4 air TRANSVERSALSÄGE**

zur Verwendung mit Transversalsäge-  
 schäften GP580R, GP582R, GP586R,  
 GP590R

75 W;  $\sphericalangle$  0-21.000 rpm; 7,6 Ncm;  
 115 x 23 mm;  $\sphericalangle$  10°;  $\bar{\bar{m}}$  200 g

**GA724****GB057R****ELAN® 4 air LOWSPEED MOTOR**

mit Intra Kupplung

80 W;  $\sphericalangle$  0-21.000 1/min; 7,6 Ncm;  
 93 x 23 mm;  $\bar{\bar{m}}$  130 g



# AESCLAP® ELAN® 4

## ELAN® 4 ZUBEHÖR

FÜR ELAN® 4 air & ELAN® 4 electro

### GB861P

GB727R

#### ELAN® 4 VERKÜRZUNGSHÜLSE

zur Verwendung mit 1-Ring Handstücken



### GB863P

GB727R

#### ELAN® 4 VERKÜRZUNGSHÜLSE

zur Verwendung mit 2-Ring Handstücken



### GB862P

GB727R

#### ELAN® 4 MIS HÜLSE

zur Verwendung mit 1-Ring Handstücken



### GB866R

#### ELAN® 4 LATERALER FRÄSERSCHUTZ

zur Verwendung mit 1-Ring Handstücken und max. Fräserdurchmesser von 4,5 mm



### TE780

#### NETZKABEL

Europa, 1,5 m

### TE730

#### NETZKABEL

Europa, 5,0 m

### TE734

#### NETZKABEL

UK, 5,0 m

### TE735

#### NETZKABEL

USA, Kanada, Japan, 3,5 m



**GA395SU**sterile  

ELAN® 4 electro Schlauchset  
für die automatische Spülung,  
komplett mit Einstechdorn und  
Fixationsklipps

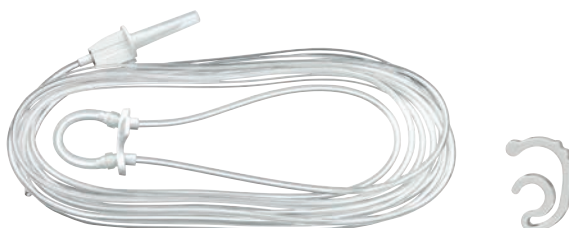
**ELAN® 4 SPRÜHDÜSEN**sterile **GA259SU**

für Kraniotomaufsätze

**GA261SU**

für 1-Ring Handstück L4

**GA262SU**

für 1-Ring Handstück L7

**GA263SU**

für 1-Ring Handstück L10

**GA264SU**

für 1-Ring Handstück L13

**GA265SU**

für 2-Ring Handstück L7

**GA266SU**

für 2-Ring Handstück L10

**GA267SU**

für 2-Ring Handstück L13

**GA268SU**

für 2-Ring Handstück L17

**GA269SU**

für 2-Ring Handstück L22

**GB796SU**

für MIS Schäfte L10

**GB797SU**

für MIS Schäfte L13

**GA258SU**

für Sägen







# AESCULAP® Acculan® 4

SEHEN. SPÜREN. ERLEBEN.

Acculan® 4, das akkubetriebene Motorensystem für die Orthopädie, Traumatologie, Thoraxchirurgie, Dermatologie / Plastische Chirurgie.

- Leistungsstark
- Zuverlässig
- Langlebig
- Sicher aufzubereiten



# AESCULAP® Acculan® 4

## BOHRMASCHINE & AUFSÄTZE

**GA330**

**GB495R**

### Acculan® 4 BOHR- UND FRÄSMASCHINE

250 W; ↻ ↻; ⚙️ 4,0 mm;  
207 x 121 x 55 mm; 📖 1.250 g

enthaltenes Zubehör:

GA678 Steriltrichter

GA672207 Spickdraht Schutzhülse

GA672211 Spüladapter

GB600840 Sprühadapter

Verschlussdeckel GA675 und NiMH Akku  
GA676 sind separat zu bestellen.

Maße und Gewicht verstehen sich inklusi-  
ve Akku und Verschlussdeckel.



**GB620R**

**GB496R**

### Acculan® 4 BOHRAUFSATZ

Dreibackenfutter schlüssellos  
0,5 - 7,4 mm

1.000 1/min; 5,0 Nm; ⚙️ 4,0 mm;  
133 x 35 mm; 📖 397 g



**GB621R**

**GB496R**

### Acculan® 4 BOHRAUFSATZ

Dreibackenfutter 0,5 - 7,4 mm

1.000 1/min; 5,0 Nm; ⚙️ 4,0 mm;  
118 x 35 mm; 📖 300 g

enthaltenes Zubehör:

Schlüssel GA031R



**GB623R**

**GB496R**

### Acculan® 4 BOHRAUFSATZ

AO klein

0 - 1.250 1/min; 4,0 Nm; ⚙️ 2,8 mm;  
90 x 35 mm; 📖 210 g





## AUFSÄTZE

**GB639R**

**GB496R**

Acculan® 4 BOHRAUFSATZ

Dreibackenfutter 0,5 - 4,0 mm

0 - 1.250 1/min; 4,0 Nm;  4,0 mm;  
105 x 35 mm;  243 g

enthaltenes Zubehör:  
Schlüssel GA062R



**GB645R**

**GB496R**

Acculan® BOHRAUFSATZ

für röntgenstrahldurchlässiges Synthes  
Winkelgetriebe 511.300

0 - 900 1/min; 110 x 35 mm;  225 g





**GB663R**

**GB496R**

Acculan® 4 BOHRAUFSATZ

Trinkle

0 - 1.000 1/min; 5,0 Nm;  4,0 mm;  
93 x 35 mm;  217 g





**GB664R**

**GB496R**

Acculan® 4 BOHRAUFSATZ

AESULAP® Sechskant

0 - 1.000 1/min; 5,0 Nm;  4,0 mm;  
86 x 35 mm;  225 g





**GB665R**

**GB496R**

Acculan® 4 BOHRAUFSATZ

Hudson/Zimmer

0 - 1.000 1/min; 5,0 Nm;  4,0 mm;  
100 x 35 mm;  230 g



# AESFULAP<sup>®</sup> Acculan<sup>®</sup> 4



## AUFSÄTZE

**GB657R**

**GB496R**

Acculan<sup>®</sup> 4 MARKRAUMBOHRAUFSATZ

AO groß

0 - 370 1/min; 12,0 Nm;  4,0 mm;  
108 x 35 mm;  300 g





**GB667R**

**GB496R**

Acculan<sup>®</sup> 4 FRÄSAUFSATZ

Dreibackenfutter 0,5 - 7,4 mm

0 - 250 1/min; 19,0 Nm;  4,0 mm;  
133 x 35 mm;  280 g

enthaltenes Zubehör:  
Schlüssel GA031R

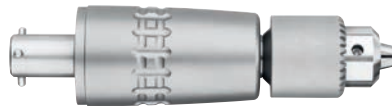



**GB668R**

**GB496R**

Acculan<sup>®</sup> 4 FRÄSAUFSATZ

AO groß

0 - 250 1/min; 19,0 Nm;  4,0 mm;  
108 x 35 mm;  300 g





**GB669R**

**GB496R**

Acculan<sup>®</sup> 4 FRÄSAUFSATZ

Hudson / Zimmer

0 - 250 1/min; 19,0 Nm;  4,0 mm;  
118 x 35 mm;  300 g





**GB670R**

**GB496R**

Acculan<sup>®</sup> 4 FRÄSAUFSATZ

Harris

0 - 250 1/min; 19,0 Nm;  4,0 mm;  
106 x 35 mm;  290 g



## AUFSÄTZE

**GB660R**

**GB496R**

### Acculan® SAGITTALSÄGEAUFSATZ

für Acculan® rapid action Sägeblätter mit einer maximalen Nutzlänge von 50 mm

«» 0 - 17.000 1/min;  $\sphericalangle$  4°47';  
89 x 36 x 44 mm;  $\text{♁}$  270 g



**GB641R**

**GB496R**

### Acculan® K-Draht AUFSATZ

für K-Drähte von 0,6 - 4,0 mm

0 - 1.250 1/min; 93 x 36 x 137 mm;  
 $\text{♁}$  285 g



# AESCULAP® Acculan® 4

## OSZILLIERENDE SÄGEN

**GA331**

**GB495R**

### Acculan® 4 OSZILLIERENDE SÄGE

250 W;  $\leftrightarrow$  0 - 13.000 1/min;  $\sphericalangle$  4,1°;  
211 x 177 x 55 mm;  $\boxplus$  1.600 g

enthaltenes Zubehör:  
GA678 Steriltrichter

Verschlussdeckel GA675 und NiMH Akku  
GA676 sind separat zu bestellen.

Maße und Gewicht verstehen sich  
inklusive Akku und Verschlussdeckel.



**GA336**

**GB498R**

### Acculan® 4 OSZILLIERENDE SÄGE GERADE

250 W;  $\leftrightarrow$  0 - 13.000 1/min;  $\sphericalangle$  4,1°;  
290 x 55 x 84 mm;  $\boxplus$  1.480 g

enthaltenes Zubehör:  
GA678 Steriltrichter

Verschlussdeckel GA675 und NiMH Akku  
GA676 sind separat zu bestellen.

Maße und Gewicht verstehen sich  
inklusive Akku und Verschlussdeckel.



**GA337**

**GB498R**

### Acculan® 4 OSZILLIERENDE STERNUM- SÄGE

250 W;  $\leftrightarrow$  0 - 13.000 1/min;  $\sphericalangle$  4,1°;  
290 x 55 x 84 mm;  $\boxplus$  1.480 g

enthaltenes Zubehör:  
GA678 Steriltrichter

Verschlussdeckel GA675 und NiMH Akku  
GA676 sind separat zu bestellen.

Maße und Gewicht verstehen sich  
inklusive Akku und Verschlussdeckel.



## STICHSÄGE

**GA334**

**GB495R**

### Acculan® 4 STICHSÄGE

250 W; ↔ 0 - 15.000 1/min; ↓ 3,2 mm;  
207 x 180 x 55 mm; ⚖ 1.540 g

enthaltenes Zubehör:

GA678 Steriltrichter

GB440215 Reinigungsplatte

GA674890 Spüladapter

Verschlussdeckel GA675 und NiMH Akku  
GA676 sind separat zu bestellen.

Maße und Gewicht verstehen sich  
inklusive Akku und Verschlussdeckel.



**GB436R**

**GB686R**

### STÜTZFUSS

zur Verwendung mit GA334 und Säge-  
blatt GC761R



# AESCULAP® Acculan® 4

## DERMATOM

**GA340**

**GB498R**

### Acculan® 4 DERMATOM

Schnittdicke schlüssellos in 1/10 mm  
Schritten einstellbar;  
Schnittdicke: 0,2 - 1,2 mm;  
Schnittbreite: 78 mm;  
passende Dermatomklinge GB228R  
(separat zu bestellen)

250 W; ↔ 0 - 6.500 1/min; ↓ 3,1 mm;  
277 x 113 x 83 mm; 1.650 g

enthaltenes Zubehör:  
GA678 Steriltrichter

Verschlussdeckel GA675 und Li-Ionen  
Akku GA346 sind separat zu bestellen.

Maße und Gewicht verstehen sich  
inklusive Akku und Verschlussdeckel.



**GA341**

**GB498R**

### Acculan® 4 DERMATOM 0,1 MM

Schnittdicke schlüssellos in 1/10 mm  
Schritten einstellbar;  
Schnittdicke: 0,1 - 1,1 mm;  
Schnittbreite: 78 mm;  
passende Dermatomklinge GB228R  
(separat zu bestellen)

250 W; ↔ 0 - 6.500 1/min; ↓ 3,1 mm;  
277 x 113 x 83 mm; 1.650 g

enthaltenes Zubehör:  
GA678 Steriltrichter

Verschlussdeckel GA675 und Li-Ionen  
Akku GA346 sind separat zu bestellen.

Maße und Gewicht verstehen sich  
inklusive Akku und Verschlussdeckel.



**BA720R**

**GB688R**

### HAUTNETZ-DERMATOM

zur Verwendung mit den Trägerplatten  
BA721 (1:1,5) / BA722 (1:3) / BA723 (1:6)

150 x 195 x 105 mm; 4.600 g

enthaltenes Zubehör:  
BA725R Messerwalze  
BA726R Handratsche





# AESCULAP® Acculan® 4

Acculan® 4 KLEINE BOHRMASCHINE

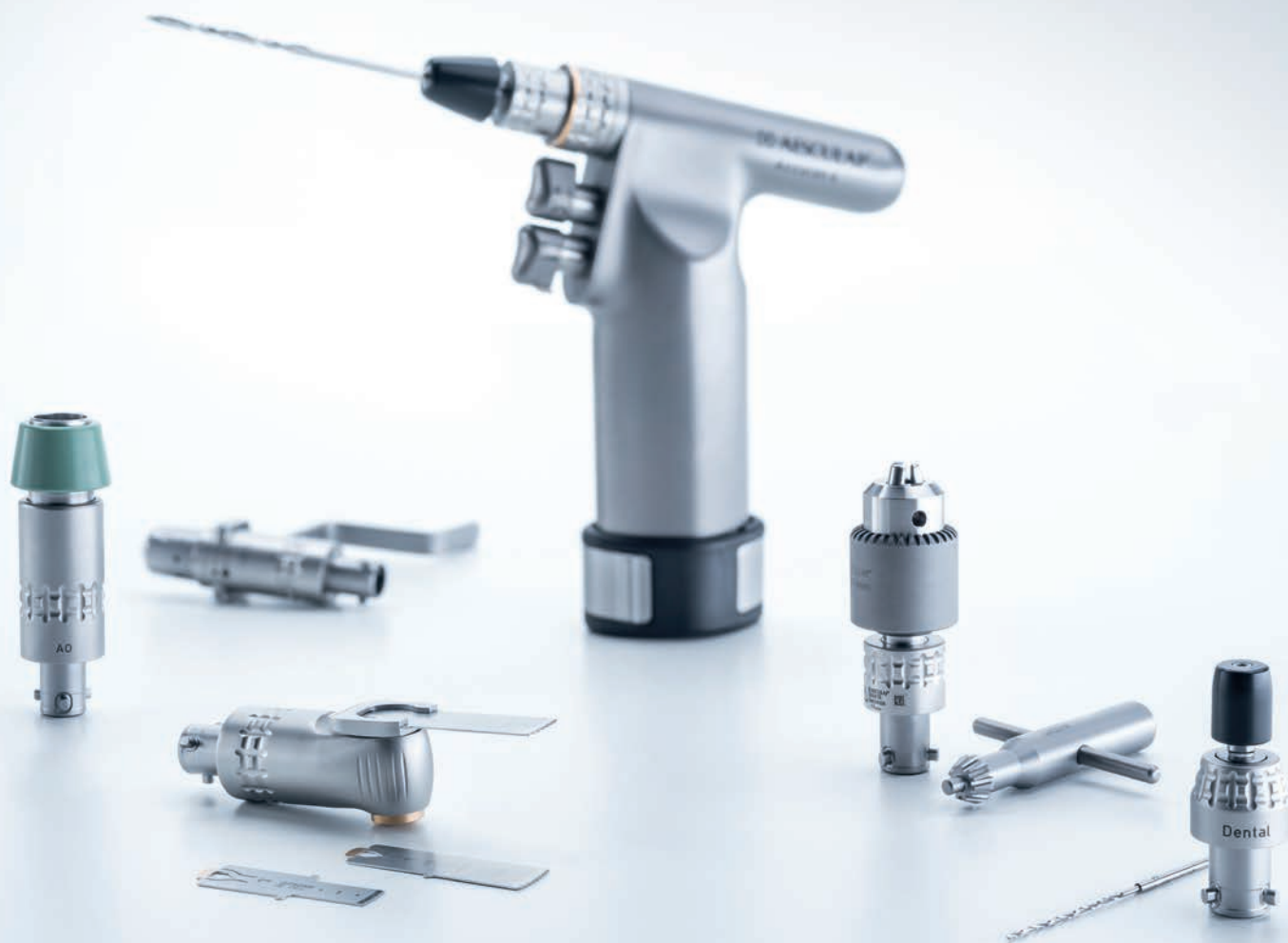

# AESCULAP® Acculan® 4

## KLEINE BOHRMASCHINE



## BOHRMASCHINE & AUFSÄTZE

**GA344**

**GB482R**

### Acculan® 4 KLEINE BOHRMASCHINE

mit Oszillations- und Gewindeschneidmodus; nicht zur Verwendung mit Acetabulumfräsern geeignet

85 W;   3,2 mm;  
177 x 124 x 55 mm;  840 g

enthaltenes Zubehör:

GA678 Steriltrichter

GA344244 Spickdraht Schutzhülse

GA344211 Spüladapter

GB600880 Sterilit® Sprühadapter

Verschlussdeckel GA675 und kleiner Li-Ionen Akku GA346 sind separat zu bestellen.

Maße und Gewicht verstehen sich inklusive Akku und Verschlussdeckel.





**GB870R**

**GB716R**

### MARKRAUMBOHRAUFSATZ

Dreibackenfutter 0,5 - 7,4 mm, nicht zur Verwendung mit Acetabulumfräsern geeignet

0 - 320 1/min; 6,5 Nm;  3,2 mm;  
105 x 29 mm;  230 g

enthaltenes Zubehör:

Schlüssel GA031R





**GB871R**

**GB716R**

### MARKRAUMBOHRAUFSATZ

AO groß, nicht zur Verwendung mit Acetabulumfräsern geeignet

0 - 320 1/min; 6,5 Nm;  3,2 mm;  
88 x 29 mm;  170 g





**GB872R**

**GB716R**

### MARKRAUMBOHRAUFSATZ

Hudson/Zimmer, nicht zur Verwendung mit Acetabulumfräsern geeignet

0 - 320 1/min; 6,5 Nm;  3,2 mm;  
86 x 25 mm;  150 g





## KLEINE BOHRMASCHINE AUFsätze

**GB881R**

**GB716R**

### BOHRAUFsatz

Dreibackenfutter 0,5 - 7,4 mm

1.250 1/min; 1,5 Nm;  3,2 mm;  
89 x 29 mm;  163 g

enthaltene Zubehör:  
Schlüssel GA031R





**GB882R**

**GB716R**

### BOHRAUFsatz

Dreibackenfutter 0,5 - 4 mm

1.250 1/min; 1,5 Nm;  3,2 mm;  
76 x 22 mm;  100 g

enthaltene Zubehör:  
Schlüssel GA062R





**GB884R**

**GB716R**

### BOHRAUFsatz

AO klein

1.250 1/min; 1,5 Nm;  2,8 mm;  
60 x 22 mm;  66 g





**GB886R**

**GB716R**

### BOHRAUFsatz

AEScULAP® Sechskant

1.250 1/min; 1,5 Nm;  3,2 mm;  
57 x 24 mm;  67 g





**GB887R**

**GB716R**

### BOHRAUFsatz

Dentalschaft

1.250 1/min; 1,5 Nm;  1,8 mm;  
56 x 22 mm;  50 g



# AESFULAP<sup>®</sup> Acculan<sup>®</sup> 4

## KLEINE BOHRMASCHINE

### AUFSÄTZE

**GB878R**

**GB716R**

#### ADAPTER

Synthes 511.300

1.250 1/min; 1,5 Nm;  
111 x 27 mm; 181 g



**GB894R**

**GB716R**

#### SPICKDRAHTAUFSATZ

für Spickdrähte von 0,6 - 3,2 mm

1.250 1/min; 3,2 mm;  
92 x 27 x 124 mm; 179 g



**GB891R**

**GB716R**

#### SAGITTALSÄGEAUFSATZ

für Sägeblätter "L-sagittal" mit einer maximalen Nutzlänge von 50 mm

0 - 15.750 1/min; 74 x 33,5 mm;  
4,5°; 179 g



**GB892R**

**GB716R**

#### STICHSÄGEAUFSATZ

für Stichsägeblätter

0 - 15.750 1/min; 135 x 24,5 mm;  
2,5 mm; 166 g





## KLEINE BOHRMASCHINE AUFsätze

**GB896R**

**GB716R**

### SCHRAUBAUFsatz

AO klein

0 - 165 1/min; 12 Nm;  1,7 mm;  
95 x 28 x 129,5 mm;  235 g





**GB897R**

**GB716R**

### SCHRAUBAUFsatz

AEScULAP® Sechskant

0 - 165 1/min; 12 Nm;  1,7 mm;  
95 x 28 x 129,5 mm;  231 g



# AESCU LAP® Acculan® 4

## LADEGERÄT & AKKUS

### GA320

#### Acculan® 4 LADEGERÄT

für Acculan® Li-Ion und NiMH Akkus  
GA346, GA676; 4 Ladeschächte;  
automatische Akku Diagnose Funktion;  
ohne Netzkabel

100 - 240 V AC; 50 / 60 Hz;  
410 x 120 x 160 mm; 2.300 g



### GA346

#### Acculan® 4 LI-ION AKKU KURZ

nur für GA340, GA341 und GA344  
mit integrierter Steuerelektronik 9,9 V;  
10,89 Wh

120 x 43 x 50 mm; 265 g



### GA676

#### Acculan® NIMH AKKU

nur für GA330, GA331, GA334,  
GA336, GA337; mit integrierter  
Steuerelektronik 9,6 V; 1,95 Ah

140 x 43 x 50 mm; 425 g



### GA679

### GB489R

#### Acculan® AKKU ENTNAHMEHILFE



### GA675

### GB487R

#### Acculan® VERSCHLUSSDECKEL

90 g



### GA678



### GB488R

#### Acculan® STERILTRICHTER



# AESCULAP® Acculan® ZUBEHÖR





## ADAPTER, SCHLÜSSEL & NETZKABEL

<p><b>GB176R</b> <span style="float: right;">GB467R</span></p> <p><b>ZIMMER ADAPTER</b>          Werkzeug: Zimmer          Motor: Hudson/Zimmer          nur in Verbindung mit GB630R,          GB656R, GB665R, GB669R, GB872R   3,8 mm</p>	<p><b>GB628R</b> <span style="float: right;">GB690R</span></p> <p><b>SYNTHES DHS / DCS ADAPTER</b>          Werkzeug: Synthes DHS / DCS          Motor: AO groß   4,2 mm</p>	<p><b>GB184R</b> <span style="float: right;">GB690R</span></p> <p><b>HARRIS ADAPTER</b>          Werkzeug: Harris          Motor: AO groß   3,5 mm</p>
--	---	--



<p><b>XF457R</b> <span style="float: right;">GB690R</span></p> <p><b>DIN ADAPTER</b>          Werkzeug: DIN          Motor: AO groß   3,8 mm</p>	<p><b>GA031R</b></p> <p><b>SCHLÜSSEL</b>          für großes Dreibackenfutter          passend für GB620R, GB621R,          GB667R, GB870R, GB881R</p>	<p><b>GA062R</b> <span style="float: right;">GB690R</span></p> <p><b>SCHLÜSSEL</b>          für kleines Dreibackenfutter          passend für GB639R, GB882R</p>
---	--	--



<p><b>TE780</b></p>
<p><b>NETZKABEL</b>          Europa,  1,5 m</p>
<p><b>TE730</b></p>
<p><b>NETZKABEL</b>          Europa,  5,0 m</p>
<p><b>TE734</b></p>
<p><b>NETZKABEL</b>          UK,  5,0 m</p>
<p><b>TE735</b></p>
<p><b>NETZKABEL</b>          USA, Kanada, Japan,  3,5 m</p>







# AESCULAP® AUFBEREITUNG

Sterilit® POWER SYSTEMS



# AESCULAP® AUFBEREITUNG

Sterilit® POWER SYSTEMS

**GB600**



Sterilit® POWER SYSTEMS

300 ml



**GB600850**

Sterilit® POWER SYSTEMS  
SPRÜHADAPTER

für ELAN® 4 air



**GB600860**

Sterilit® POWER SYSTEMS  
SPRÜHADAPTER

für ELAN® 4 electro



**GB600870**

Sterilit® POWER SYSTEMS  
SPRÜHADAPTER

für ELAN® 4 MIS



**GB600840**

Sterilit® POWER SYSTEMS  
SPRÜHADAPTER

für Acculan® 4



**GB600880**

Sterilit® POWER SYSTEMS  
SPRÜHADAPTER

für Acculan® 4 Kleine Bohrmaschine  
und ELAN® 4 electro Bohrmaschine



# AESCALAP® MASCHINELLE AUFBEREITUNG

- Die Lösung zur Lagerung und maschinelle Aufbereitung Ihrer Aesculap Motorsysteme
- Detaillierte Informationen entnehmen Sie bitte der entsprechenden Gebrauchsanweisung



# AESULAP® MASCHINELLE AUFBEREITUNG

ECCOS® HALTERUNGEN

ELAN® 4 ECCOS® SETS

## GB261R

ELAN® 4 electro ECCOS® SET

enthaltene Halterungen:

GB073R

GB076R

GB083R

GB085R

GB719R

GB072R

JF212R

 56 mm

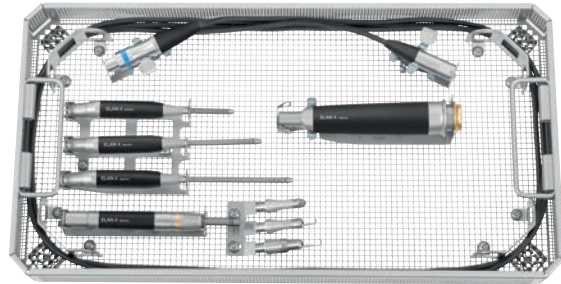

## GB260R

ELAN® 4 air ECCOS® SET

enthaltene Halterungen:

GB053R

GB056R

GB063R

GB065R

GB719R

GB072R

JF212R

 56 mm

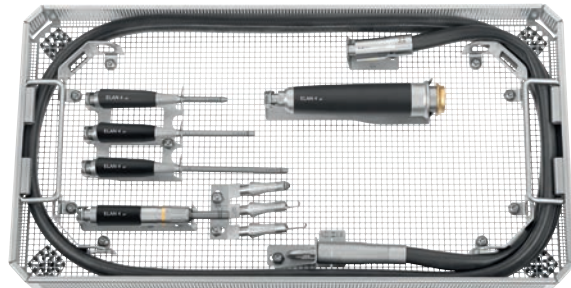

## GB262R

ELAN® 4 electro ECCOS® SET  
FÜR BOHRMASCHINE GA844

enthaltene Halterungen:

GB072R

GB482R

GB715R

GB716R

JG340

JG342





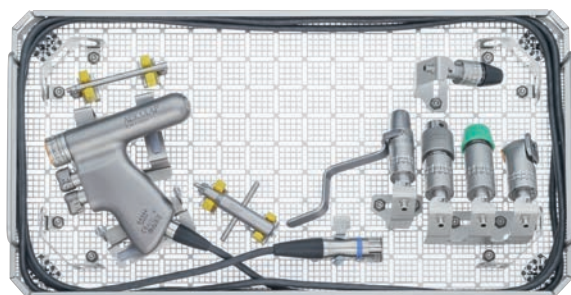





















JG344

 106 mm



# ECCOS® HALTERUNGEN









## ELAN® 4® electro

<p><b>GB073R</b></p> <p>ECCOS® HALTERUNG</p> <p>Set bestehend aus 2 Stück für Motorkabel GA804, GA805, GA806</p>  56 mm	<p><b>GB076R</b></p> <p>ECCOS® HALTERUNG</p> <p>für Trepanationsmotor GA822</p>  56 mm	<p><b>GB077R</b></p> <p>ECCOS® HALTERUNG</p> <p>für Intra Motor GA824</p>  56 mm
 	 	 
<p><b>GB082R</b></p> <p>ECCOS® HALTERUNG</p> <p>für 1 Handstück</p>  56 mm	<p><b>GB083R</b></p> <p>ECCOS® HALTERUNG</p> <p>für 3 Handstücke</p>  56 mm	<p><b>GB085R</b></p> <p>ECCOS® HALTERUNG</p> <p>für Kraniotom GA849</p>  56 mm
 	 	 
<p><b>GB086R</b></p> <p>ECCOS® HALTERUNG</p> <p>für Mikro-Sagittalsäge GA836</p>  56 mm	<p><b>GB087R</b></p> <p>ECCOS® HALTERUNG</p> <p>für Stichsäge GA832, GA837</p>  56 mm	<p><b>GB088R</b></p> <p>ECCOS® HALTERUNG</p> <p>für Sägen GA831, GA833</p>  56 mm
 	 	 

# AESCALAP® MASCHINELLE AUFBEREITUNG

ECCOS® HALTERUNGEN

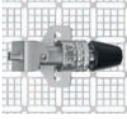
ELAN® 4 electro

GB482R	GB715R	GB716R
<p>ECCOS® HOLDER für ELAN® 4 electro Bohrmaschine GA844</p> <p> 106 mm</p>	<p>ECCOS® HOLDER für 1 Aufsatz GB870R, GB871R, GB872R, GB878R, GB881R, GB884R, GB892R, GB896R, GB897R</p> <p> 106 mm</p>	<p>ECCOS® HOLDER für 3 Aufsätze GB870R, GB871R, GB872R, GB878R, GB881R, GB884R, GB892R, GB896R, GB897R</p> <p> 106 mm</p>
 	 	 

# ECCOS® HALTERUNGEN & SPÜLVORRICHTUNGEN

## ELAN® 4 electro

### GB084R

ECCOS® HALTERUNG  
für MIS Handstück GA860  
 56 mm

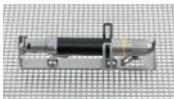

### GB723R

ECCOS® HALTERUNG  
für 2 MIS Schäfte GB920R - GB927R  
 56 mm



### GB692R

SPÜLVORRICHTUNG  
für Anwendungsteile  
(nicht für die Sterilisation geeignet)

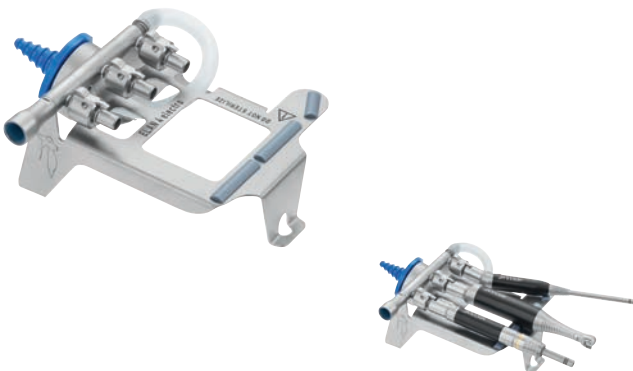

### GB679R

SPÜLVORRICHTUNG  
für 4 MIS Schäfte  
(nicht für die Sterilisation geeignet)

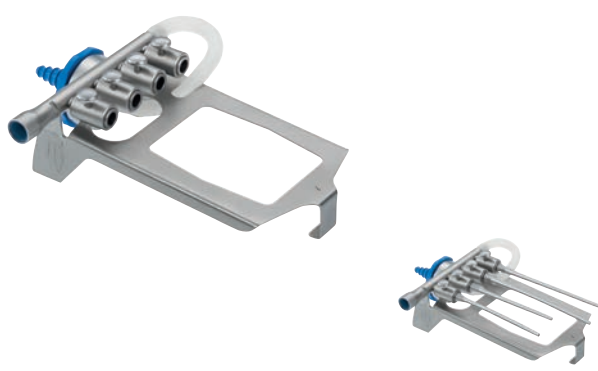

### GB698R

SPÜLADAPTER  
für Anwendungsteile  
(für die manuelle Reinigung)



### GB699R

























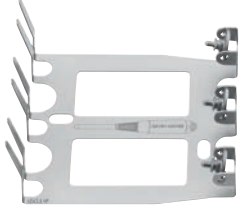

SPÜLADAPTER  
für MIS Schäfte  
(für die manuelle Reinigung)



# AESCLAP® MASCHINELLE AUFBEREITUNG

## ECCOS® HALTERUNGEN

### ELAN® 4 air

<p><b>GB053R</b></p> <p>ECCOS® HALTERUNG für Motorschläuche GA705R, GA706R, GA707R</p>  56 mm	<p><b>GB056R</b></p> <p>ECCOS® HALTERUNG für Trepanationsmotor GA722</p>  56 mm	<p><b>GB057R</b></p> <p>ECCOS® HALTERUNG für Intra Motor GA724</p>  56 mm
 	 	 
<p><b>GB062R</b></p> <p>ECCOS® HALTERUNG für 1 Handstück</p>  56 mm	<p><b>GB063R</b></p> <p>ECCOS® HALTERUNG für 3 Handstücke</p>  56 mm	<p><b>GB065R</b></p> <p>ECCOS® HALTERUNG für Kraniotom GA749</p>  56 mm
 	 	 
<p><b>GB066R</b></p> <p>ECCOS® HALTERUNG für Mikro-Sagittalsäge GA736</p>  56 mm	<p><b>GB067R</b></p> <p>ECCOS® HALTERUNG für Stichsägen GA732, GA737</p>  56 mm	<p><b>GB068R</b></p> <p>ECCOS® HALTERUNG für Sägen GA731, GA733</p>  56 mm
 	 	 



# ECCOS® HALTERUNGEN & SPÜLVORRICHTUNGEN

## ELAN® 4 air

### GB064R

ECCOS® HALTERUNG  
für MIS Handstück GA760  
 56 mm



### GB723R

ECCOS® HALTERUNG  
für 2 MIS Schäfte GB920R - GB927R  
 56 mm



### GB691R

SPÜLVORRICHTUNG  
für Anwendungsteile  
(nicht für die Sterilisation geeignet)

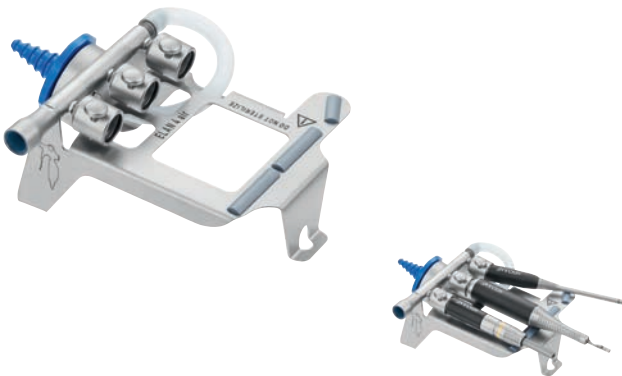

### GB679R

SPÜLVORRICHTUNG  
für 4 MIS Schäfte  
(nicht für die Sterilisation geeignet)

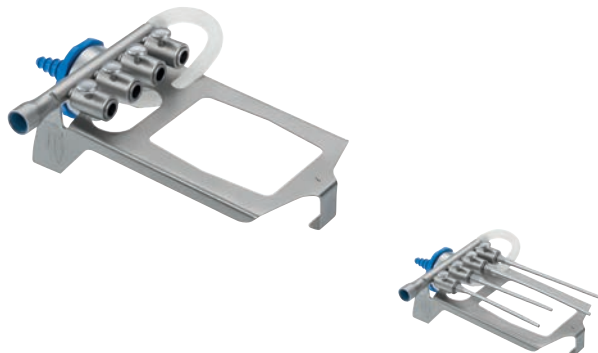

### GB697R

SPÜLADAPTER  
für Anwendungsteile  
(für die manuelle Reinigung)



### GB699R

SPÜLADAPTER  
für MIS Schäfte  
(für die manuelle Reinigung)



# AESCALAP® MASCHINELLE AUFBEREITUNG

ECCOS® HALTERUNGEN

ELAN® 4 ECCOS® SETS

<p><b>GB718R</b></p> <p>ECCOS® HALTERUNG für 12 Fräser (1-Ring und 2-Ring)</p>  56 mm	<p><b>GB719R</b></p> <p>ECCOS® HALTERUNG für 3 Kraniotomaufsätze</p>  56 mm	<p><b>GB720R</b></p> <p>ECCOS® UNIVERSAL-HALTERUNG für Sägeblätter</p>  56 mm
 	 	 
<p><b>GB729R</b></p> <p>ECCOS® HALTERUNG für 2 Stichsägenschäfte</p>  56 mm	<p><b>GB730R</b></p> <p>ECCOS® HALTERUNG für 2 Transversalsägeschäfte</p>  56 mm	<p><b>GB072R</b></p> <p>ECCOS® AUFWICKELHILFE für Kabel und Schläuche (Set mit 4 St.)</p>  56 mm
 	 	 
<p><b>GB727R</b></p> <p>ECCOS® HALTERUNG für Handstück-Haltehülsen GB861P, GB862P, GB863P</p>  56 mm	<p><b>GB572R</b></p> <p>ECCOS® FIXATION für GB300R - GB308R</p>  56 mm	
 	 	

## ECCOS® SETS

### Acculan® 4

#### GB257R

##### ECCOS® SET

für Acculan® 4 Kleine Bohrmaschine  
GA344

 106 mm

enthaltene Halterungen:

GB482R

GB487R

GB488R

GB715R

GB716R

JG340

JG342

JG344

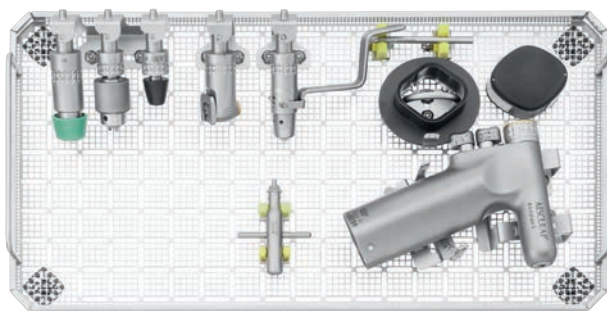

#### GB243R

##### ECCOS® SET

für 2 Acculan® 4 Maschinen

 106 mm

enthaltene Halterungen:

GB481R

GB487R

GB488R

GB495R

GB496R

GB497R

GB690R

JG340

JG342

JG344

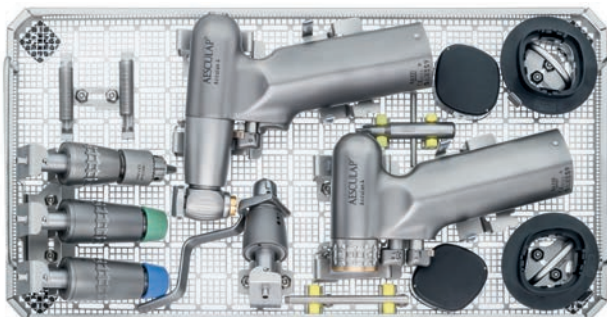

#### GB256R

##### ECCOS® SET

für Acculan® 4 Dermatome

 106 mm

enthaltene Halterungen:

GB487R

GB488R

GB498R



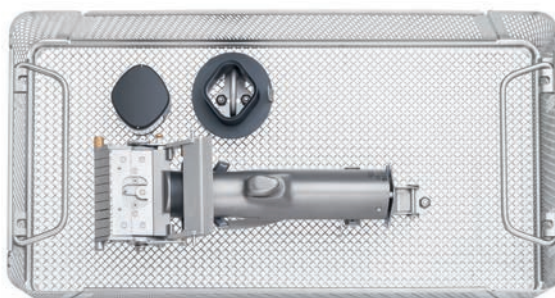











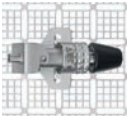

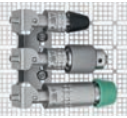
JJ464R



# AESCALAP® MASCHINELLE AUFBEREITUNG

## ECCOS® HALTERUNGEN

### Acculan® 4

<p><b>GB482R</b></p> <p>ECCOS® HALTERUNG für Acculan® 4 Kleine Bohrmaschine GA344</p> <p> 106 mm</p>  	<p><b>GB715R</b></p> <p>ECCOS® HALTERUNG für 1 Aufsatz GB870R, GB871R, GB872R, GB878R, GB881R, GB884R, GB892R, GB896R, GB897R</p> <p> 106 mm</p>  	<p><b>GB716R</b></p> <p>ECCOS® HALTERUNG für 3 Aufsätze GB870R, GB871R, GB872R, GB878R, GB881R, GB884R, GB892R, GB896R, GB897R</p> <p> 106 mm</p>  
<p><b>GB495R</b></p> <p>ECCOS® HALTERUNG für GA330, GA331, GA334</p> <p> 106 mm</p>  	<p><b>GB496R</b></p> <p>ECCOS® HALTERUNG für GB620R, GB621R, GB623R, GB639R, GB641R, GB645R GB660R, GB663R, GB664R, GB665R, GB657R, GB667R, GB668R, GB669R, GB670R</p> <p> 106 mm</p>  	<p><b>GB497R</b></p> <p>ECCOS® HALTERUNG für GB620R, GB621R, GB623R, GB639R, GB641R, GB645R GB660R, GB663R, GB664R, GB665R, GB657R, GB667R, GB668R, GB669R, GB670R</p> <p> 106 mm</p>  

# ECCOS® HALTERUNGEN











## Acculan® 4

<b>GB487R</b>	<b>GB488R</b>	<b>GB489R</b>
ECCOS® HALTERUNG für GA675  56 mm	ECCOS® HALTERUNG für GA678  76 mm	ECCOS® HALTERUNG für GA679  106 mm
		
		
<b>GB498R</b>	<b>GB686R</b>	
ECCOS® HALTERUNG für GA336, GA337, GA340, GA341  106 mm	ECCOS® HALTERUNG für GB436R  56 mm	
		
		

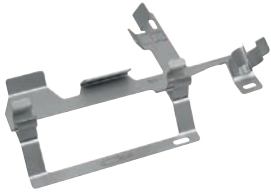
# AESCALAP<sup>®</sup> MASCHINELLE AUFBEREITUNG

## ECCOS<sup>®</sup> HALTERUNGEN

Acculan<sup>®</sup> 4

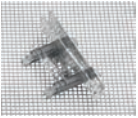
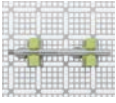
<b>GB485R</b>	<b>GB486R</b>	<b>GB688R</b>
ECCOS <sup>®</sup> HALTERUNG für GA875  56 mm	ECCOS <sup>®</sup> HALTERUNG für GA878  56 mm	ECCOS <sup>®</sup> HALTERUNG für BA720R  106 mm
		
		
<b>GB481R</b>	<b>GB690R</b>	
ECCOS <sup>®</sup> HALTERUNG für Sägeblätter und anderes Zubehör  56 mm	ECCOS <sup>®</sup> HALTERUNG 0,5 mm für Spickdrahtschutzhülsen GA672207, GA344244	
		
		

## ECCOS® HALTERUNGEN UNIVERSELLE WERKZEUGE

GB459R	JG303R	JG342 / JG344
ECCOS® MONTAGESET	ERSATZSCHRAUBEN-SET	SILIKON HALTERUNG 8,5 mm / 12 mm Schraube JG303R ist separat zu bestellen.
		

# AESCALAP® POWER SYSTEMS

## ÜBERSICHT WERKZEUGANSCHLÜSSE

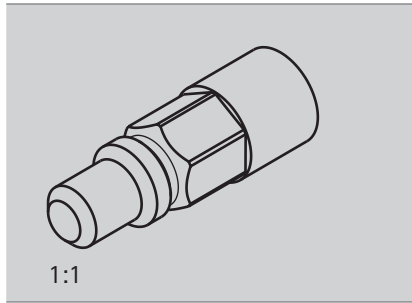

AO GROSS

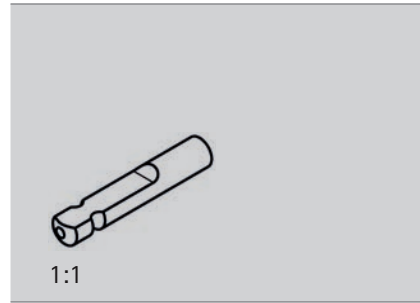

AO KLEIN

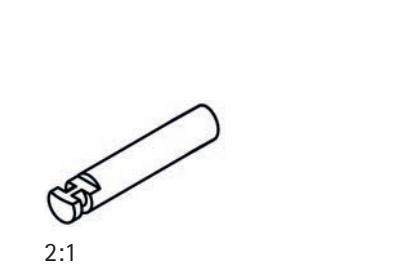

DENTAL

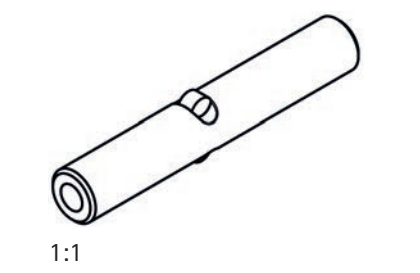

DIN

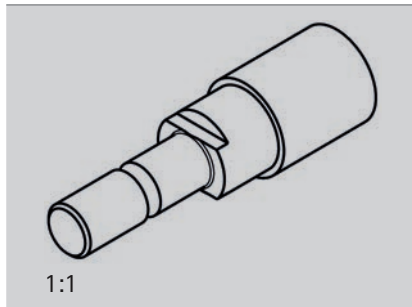

HARRIS

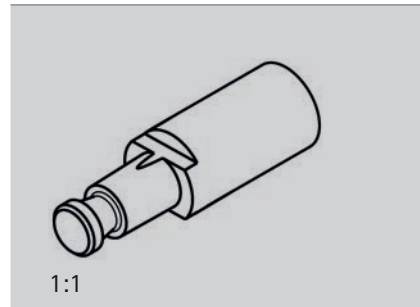

HUDSON

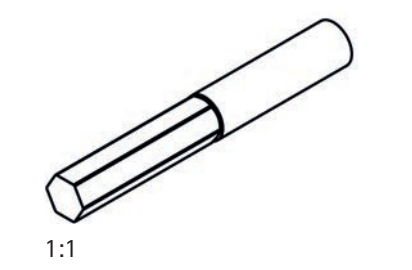

SECHSKANT

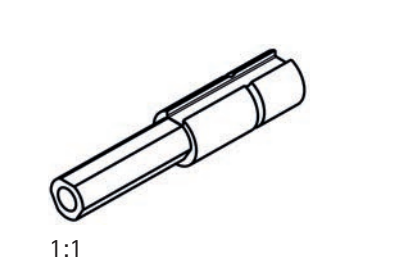

SYNTHES  
DHS/DCS

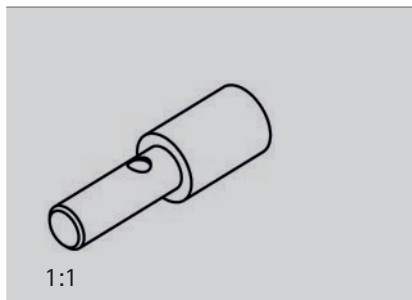



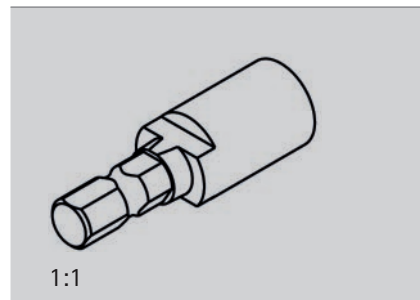









TRINKLE

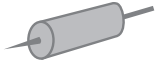

ZIMMER







## ZEICHENERKLÄRUNG

	LATEXFREI ALLE ARTIKEL IN DIESEM KATALOG SIND LATEXFREI
	ARTIKEL-NUMMER DER PASSENDEN ECCOS® HALTERUNG
	RECHTS- / LINKSLAUF
	RECHTSLAUF
	OSZILLATIONSFREQUENZ
	SCHWINGWINKEL
	HUB
	KANÜLIERUNG
	KABELLÄNGE
	GEWICHT
	VERPACKUNGSEINHEIT
	ARTIKEL FÜR DEN EINMALGEBRAUCH
	ERFORDERLICHE SIEBKORBHÖHE
	STERIL

# AESCULAP® POWER SYSTEMS

## INDEX

Art. Nr.		Art. Nr.		Art. Nr.		Art. Nr.	
BA720R	40	GA761	24	GB082R	53	GB668R	36
GA031R	47	GA762	24	GB083R	53	GB669R	36
GA062R	47	GA763	24	GB084R	55	GB670R	36
GA258SU	31	GA764	24	GB085R	53	GB679R	55, 57
GA259SU	31	GA765	25	GB086R	53	GB686R	61
GA261SU	31	GA766	25	GB087R	53	GB688R	62
GA262SU	31	GA767	25	GB088R	53	GB690R	62
GA263SU	31	GA768	25	GB176R	47	GB691R	57
GA264SU	31	GA769	25	GB184R	47	GB692R	55
GA265SU	31	GA800	7	GB243R	59	GB697R	57
GA266SU	31	GA804	8	GB256R	59	GB698R	55
GA267SU	31	GA805	8	GB257R	59	GB699R	55, 57
GA268SU	31	GA806	7	GB260R	52	GB715R	54, 60
GA269SU	31	GA808	7	GB261R	52	GB716R	54, 60
GA320	46	GA810	7	GB262R	52	GB718R	58
GA330	34	GA822	8	GB436R	39	GB719R	58
GA331	38	GA824	8	GB459R	63	GB720R	58
GA334	39	GA831	15	GB481R	62	GB723R	55, 57
GA336	38	GA832	15	GB482R	54, 60	GB727R	58
GA337	38	GA833	15	GB485R	62	GB729R	58
GA340	40	GA836	15	GB486R	62	GB730R	58
GA341	40	GA837	15	GB487R	61	GB796SU	31
GA344	42	GA844	16	GB488R	61	GB797SU	31
GA346	46	GA849	9	GB489R	61	GB861P	30
GA395SU	31	GA860	13	GB495R	60	GB862P	30
GA675	46	GA861	10	GB496R	60	GB863P	30
GA676	46	GA862	10	GB497R	60	GB866R	30
GA678	46	GA863	10	GB498R	61	GB870R	16, 42
GA679	46	GA864	10	GB572R	58	GB871R	16, 42
GA702R	21	GA865	11	GB600	50	GB872R	16, 42
GA703R	21	GA866	11	GB600840	50	GB878R	18, 44
GA705R	22	GA867	11	GB600850	50	GB881R	17, 43
GA706R	22	GA868	11	GB600860	50	GB882R	17, 43
GA707R	22	GA869	11	GB600870	50	GB884R	17, 43
GA708	22	GB053R	56	GB600880	50	GB886R	17, 43
GA710R	21	GB056R	56	GB620R	34	GB887R	17, 43
GA712R	21	GB057R	56	GB621R	34	GB891R	18, 44
GA713R	21	GB062R	56	GB623R	34	GB892R	18, 44
GA715R	21	GB063R	56	GB628R	47	GB894R	18, 44
GA722	22	GB064R	57	GB639R	35	GB896R	19, 45
GA724	29	GB065R	56	GB641R	37	GB897R	19, 45
GA731	29	GB066R	56	GB645R	35	GB920R	13, 27
GA732	29	GB067R	56	GB657R	36	GB921R	13, 27
GA733	29	GB068R	56	GB660R	37	GB922R	13, 27
GA736	29	GB072R	58	GB663R	35	GB925R	13, 27
GA737	29	GB073R	53	GB664R	35	GB926R	13, 27
GA749	23	GB076R	53	GB665R	35	GB927R	13, 27
GA760	27	GB077R	53	GB667R	36	GB941R	9, 23

Art. Nr.	
GB942R	9, 23
GB943R	9, 23
GB945R	9, 23
GB947R	9, 23
JF212R	52
JG303R	63
JG342/ JG344	63
JG344	52
TE730	30, 47
TE734	30, 47
TE735	30, 47
TE780	30, 47
XF457R	47

#### Vertrieb Österreich

B. Braun Austria GmbH | Aesculap Division | Otto-Braun-Straße 3-5 | 2344 Maria Enzersdorf  
Tel. +43 2236 46541-0 | Fax +43 2236 48479 | [www.bbraun.at](http://www.bbraun.at)

#### Vertrieb Schweiz

B. Braun Medical AG | Aesculap Division | Seesatz 17 | 6204 Sempach  
Tel. +41 58258 5000 | Fax +41 58258 6000 | [www.bbraun.ch](http://www.bbraun.ch)

## AESCULAP® – a B. Braun brand

Aesculap AG | Am Aesculap-Platz | 78532 Tuttlingen | Deutschland  
Tel. 07461 95-0 | Fax 07461 95-2600 | [www.aesculap.de](http://www.aesculap.de)

Die Hauptproduktmarke „Aesculap“ und die Produktmarken „Acculan“, „ECCOS“, „ELAN“ und „Sterilit“ sind eingetragene Marken der Aesculap AG.

Technische Änderungen vorbehalten. Dieser Prospekt darf ausschließlich zur Information über unsere Erzeugnisse verwendet werden. Nachdruck, auch auszugsweise, verboten.