

Gynäkologie

*Gynecology*

*Laparoscopy, Pelviscopy*

Laparoskopie, Pelviskopie

---

*Hysterectomy*

Hysterektomy

---

*Diagnostic and operative  
Hysteroscopy*

Diagnostische und operative  
Hysteroskopie

---

*Interdisciplinary Applications*

Interdisziplinäre Anwendungen



**Laparoskopie**

***Laparoscopy***

## Laparoscopy

## Laparoskopie

1

*Basic Sets*

Basis-Sets

2

*Telescopes*

Optiken

3

*Trocar Sleeves / Dilatation / Extraction /  
Reducing Sleeves*

Trokarhülsen / Dilatation / Extraktion /  
Reduzierhülsen

4

*Grasping Forceps / Dissectors / Biopsy Forceps*

Greifzangen / Dissektoren / PE-Zangen

5

*Scissors*

Scheren

6

*Bipolar Forceps and Scissors*

Bipolare Zangen und Scheren

7

*HF Electrodes (monopolar / bipolar)*

HF-Elektroden (monopolar / bipolar)

8

*Suction and Irrigation Tubes /  
Multifunction Instruments*

Saug-und Spülrohre /  
Multifunktions-Instrumente

9

*Retractors / Holding Arm Systems*

Retraktoren / Haltearm-Systeme

10

*Applicators / Tissue Clamps*

Applikatoren / Gewebeklemmen

11

*Needle Holder / Knot Pusher / Fascia Closure*

Nadelhalter / Knotenschieber / Faszienverschluss

12

*Cannulas / Probes / Myoma Screw*

Kanülen / Taststäbe / Myombohrer

13

*Bariatric Surgery*

Adipositas-Chirurgie

14

*Single-Port Surgery*

Single-Port Chirurgie

15

*Units / Accessories*

Geräte / Zubehör

16

*Choledochoscopy*

Choledochoskopie

17

*Training models*

Trainingsmodelle

## Basic Set

for all laparoscopic Operations

## Basis-Set

für alle laparoskopischen Eingriffe

Artikel	Article	Typen / Types	Seite / Page	Pcs
INSUFFLATOR Highflow 45 EVAC + HEAT	<i>INSUFFLATOR Highflow 45 EVAC + HEAT</i>	<b>22350311</b>	BDE 152	1
VERES-Kanüle	<i>VERES cannula</i>	<b>8302.12</b>	BDE 156	1
FLUID CONTROL LAP 2216 Set	<i>FLUID CONTROL LAP 2216 Set</i>	<b>22160011</b>	BDE 163	1
LED-Lichtquelle ENDOLIGHT LED 2.1 Set	<i>LED Light Source ENDOLIGHT LED 2.1 Set</i>	<b>51630011</b>	Imaging	1
Fiber Lichtleiter	<i>Fiber Light cable</i>		Imaging	1
ENDOCAM Logic HD	<i>ENDOCAM Logic HD</i>	<b>5525</b>	Imaging	1
Monitore	<i>Monitors</i>		Imaging	1
Gerätewagen	<i>Unit trolley</i>		Imaging	1

## Basic Set

for laparoscopic Cholecystectomy

## Basis-Set

zur laparoskopischen Cholezystektomie

Artikel	Article	Typen / Types	Seite / Page	Stk./pcs.
Optik 10 mm, 30°	Telescope 10 mm, 30°	<b>8934.432</b>	BDE 18	<b>1</b>
und/oder	and/or			
Optik 10 mm, 0°	Telescope 10 mm, 0°	<b>8934.431</b>	BDE 18	<b>1</b>
Fiber Lichtleiter	Fiber light cable	<b>806650231</b>	BDE 18	<b>1</b>
RIWO-ART-Trokarhülse 5,5 mm	RIWO-ART trocar sleeve 5.5 mm	<b>8921.013</b>	BDE 28	<b>2-3</b>
Trokar, kegelig-spitz	Trocar, conical tip	<b>8921.113</b>	BDE 28	<b>2-3</b>
und/oder	and/or			
Trokarhülse 5,5 mm, selbsthaltend	Trocar sleeve 5.5 mm, self-retaining	<b>8919.351</b>	BDE 32	<b>2-3</b>
Trokar, kegelig-spitz	Trocar, conical tip	<b>8919.3512</b>	BDE 32	<b>2-3</b>
Trokarhülse 10 mm	Trocar sleeve 10 mm	<b>8923.013</b>	BDE 34	<b>2</b>
Trokar, kegelig-spitz	Trocar, conical tip	<b>8923.113</b>	BDE 34	<b>2</b>
Führungsstab 5 mm	Guide rod 5 mm	<b>8923.921</b>	BDE 39	<b>1</b>
Dilatations- und Führungshülse 5-10 mm	Dilatation and guide sleeve 5-10 mm	<b>8923.931</b>	BDE 39	<b>1</b>
Instrumentierhülse und Extraktor 5-10 mm	Instrument sleeve and extractor 5-10 mm	<b>8385.50</b>	BDE 39	<b>1</b>
Veres-Kanüle	VERES cannula	<b>8302.12</b>	BDE 1156	<b>1</b>
<b>Multifunktionelles Saug-Spül-System</b> <i>Multifunction Suction-Irrigation System</i>				
Saug-Spül-Rohr 5 mm	Suction-Irrigation tube 5 mm	<b>8383.911</b>	BDE 90	<b>1</b>
Saug-Spül-Handgriff	Suction-Irrigation handle	<b>8385.901</b>	BDE 90	<b>1</b>
Verschlusskappe	Sealing cap	<b>8385.902</b>	BDE 90	<b>1</b>
<b>ERAGONmodular</b> <i>ERAGONmodular</i>				
Greifzange mit Zahnreihe 5 mm	Grasping forceps with teeth 5 mm	<b>83932925</b>	BDE 60	<b>1</b>
Atraumatische Greifzange 5 mm	Atraumatic grasping forceps 5 mm	<b>83931817</b>	BDE 65	<b>2</b>
Maryland Dissektor 5 mm	Maryland dissector 5 mm	<b>83932817</b>	BDE 53	<b>1</b>
Schere "Metzenbaum" 5 mm	Scissors "Metzenbaum" 5 mm	<b>83930417</b>	BDE 74	<b>1</b>
Greifzange, 2/3 krallig, 10 mm	Grasping forceps, 2/3 claws, 10 mm	<b>83952048</b>	BDE 70	<b>1</b>
Atraumatische Tellerfasszange 10 mm	Atraumatic plate-shaped grasping forceps 10 mm	<b>83952347</b>	BDE 70	<b>1</b>
<b>Haken-Elektrode 5 mm</b> <i>Hook electrode 5 mm</i>				
Clip-Applikator 10 mm	Clip applicator 10 mm	<b>8389.911</b>	BDE 105	<b>1</b>
Ligaclips, VE=108 Stück	Ligaclips, PACK=108 PCS	<b>8389.915</b>	BDE 105	<b>1</b>
Endo-Spreizer	Endodilator	<b>8386.001</b>	BDE 41	<b>1</b>
Nadelzange	Needle-tipped grasper	<b>8756.201</b>	BDE 114	<b>1</b>
Dichtkonus, 12-15 mm	Closure cone, 12-15 mm	<b>8943.915</b>	BDE 114	<b>1</b>
Laparoskopischer Bergebeutel	Laparoscopic Retrieval Bag	<b>4957100</b>	BDE 169	<b>1</b>
HF-Anschlusskabel	HF connecting cable	<b>8106</b>	BDE 163	<b>2</b>

## Basic Set

for laparoscopic Cholecystectomy

## Basis-Set

zur laparoskopischen Cholezystektomie

Artikel	Article	Typen / Types	Seite / Page	Stk./pcs.
<b>Zusätzlich auf Wunsch:</b>	<b>Options:</b>			
Optik 5,3 mm, 30°	Telescope 5.3 mm, 30°	<b>8935.442</b>	BDE 18	<b>1</b>
Trokar mit Schutzhülse	Trocar with protective sleeve	<b>8923.133</b>	BDE 34	<b>1</b>
RIWO-ART Trokarhülse 5,5 mm	RIWO-ART trocar sleeve 5.5 mm	<b>8921.013</b>	BDE 39	<b>1</b>
Trokar, kegelig-spitz	Trocar, conical tip	<b>8921.113</b>	BDE 39	<b>1</b>
<b>ERAGONmodular</b>	<b>ERAGONmodular</b>			
Greifzange, stumpf, 5 mm	Grasping forceps, blunt, 5 mm	<b>83931957</b>	BDE 62	<b>1</b>
Probe-Exzisionszange 5 mm	Biopsy forceps 5 mm	<b>83930937</b>	BDE 66	<b>1</b>
Dissektionszange 10 mm	Dissection forceps 10 mm	<b>83952268</b>	BDE 69	<b>1</b>
<b>ERAGONbipolar</b>	<b>ERAGONbipolar</b>			
Greif- und Präparierzange, bipolar, 5 mm	Grasping and preparation forceps, 5 mm	<b>839300312</b>	BDE 83	<b>1</b>
Bipolar-Kabel	Bipolar cable	<b>8108</b>	BDE 164	<b>1</b>

1

## Basic Set

for laparoscopic Cholecystectomy

## Basis-Set

zur laparoskopischen Cholezystektomie

Artikel	Article	Typen / Types	Seite / Page	Stk. / pcs.
Zusätzlich zur laparoskopischen Choledochusrevision:		<i>Options for laparoscopic inspection of the common bile duct:</i>		
Cholangiografie-Zange	<i>Cholangiography forceps</i>	<b>8383.311</b>	BDE 81	<b>1</b>

1



## Basic Set

### for laparoscopic Appendectomy

## Basis-Set

### zur laparoskopischen Appendektomie

Artikel	Article	Typen / Types	Seite / Page	Stk. / pcs.
Optik 10 mm, 30°	Telescope 10 mm, 30°	<b>8934.432</b>	BDE 18	<b>1</b>
und/oder	and/or			
Optik 10 mm, 0°	Telescope 10 mm, 0°	<b>8934.431</b>	BDE 18	<b>1</b>
Fiber Lichtleiter	Fiber light cable	<b>806650231</b>	BDE 18	<b>1</b>
RIWO-ART-Trokarhülse 10 mm	RIWO-ART-trocar sleeve 10 mm	<b>8923.013</b>	BDE 28	<b>2</b>
Trokar, kegelig-spitz	Trocar, conical tip	<b>8923.113</b>	BDE 28	<b>2</b>
und/oder	and/or			
Trokarhülse 5,5 mm, selbsthaltend	Trocar sleeve 5.5 mm, self-retaining	<b>8919.351</b>	BDE 32	<b>2-3</b>
Trokar, kegelig-spitz	Trocar, conical tip	<b>8919.3512</b>	BDE 32	<b>2-3</b>
RIWO-ART-Trokarhülse 5,5 mm	RIWO-ART-trocar sleeve 5.5 mm	<b>8921.013</b>	BDE 34	<b>2-3</b>
Trokar, kegelig-spitz	Trocar, conical tip	<b>8921.113</b>	BDE 34	<b>2-3</b>
Führungsstab 5 mm	Guide rod 5 mm	<b>8923.921</b>	BDE 39	<b>1</b>
Instrumentierhülse und Extraktor 5-10 mm	Instrument sleeve and extractor 5-10 mm	<b>8385.50</b>	BDE 39	<b>1</b>
<b>ERAGONmodular</b>	<b>ERAGONmodular</b>			
Greif- und Koagulationszange 5 mm	Grasping and coagulation forceps 5 mm	<b>83932877</b>	BDE 65	<b>1</b>
Atraumatische Greifzange 5 mm	Atraumatic grasping forceps 5 mm	<b>83931817</b>	BDE 53	<b>1</b>
Maryland Dissektor 5 mm	Maryland dissector 5 mm	<b>83932817</b>	BDE 49	<b>1</b>
Greif- und Dissektionszange 5 mm	Grasping and dissection forceps 5 mm	<b>83932827</b>	BDE 52	<b>1</b>
Schere "Metzenbaum" 5 mm	Scissors "Metzenbaum" 5 mm	<b>83930417</b>	BDE 74	<b>1</b>
<b>ERAGONbipolar</b>	<b>ERAGONbipolar</b>			
Greif- und Präparierzange, bipolar, 5 mm	Grasping and preparation forceps, bipolar, 5 mm	<b>839300312</b>	BDE 83	<b>1</b>
<b>Multifunktionelles Saug-Spül-System</b>	<b>Multifunction Suction-Irrigation System</b>			
Saug-Spül-Rohr 5 mm	Suction-Irrigation tube 5 mm	<b>8383.911</b>	BDE 90	<b>1</b>
Saug-Spül-Handgriff	Suction-Irrigation Handle	<b>8385.901</b>	BDE 90	<b>1</b>
Verschlusskappe	Sealing cap	<b>8385.902</b>	BDE 90	<b>1</b>
<b>Laparoskopischer Bergebeutel</b>	<b>Laparoscopic Retrieval Bag</b>	<b>4957100</b>	BDE 169	<b>1</b>
Taststab 5 mm	Probe 5 mm	<b>8383.66</b>	BDE 119	<b>1</b>
VERES-Kanüle	VERES cannula	<b>8302.12</b>	BDE 156	<b>1</b>
HF-Kabel Bipolar	HF-connecting cable bipolar	<b>8108</b>	BDE 164	<b>1</b>
HF-Kabel Monopolar	HF-connecting cable monopolar	<b>8106</b>	BDE 163	<b>1</b>

## Basic Set

for laparoscopic Appendectomy

## Basis-Set

zur laparoskopischen Appendektomie

Artikel	Article	Typen / Types	Seite / Page	Stk./ pcs.
Zusätzlich auf Wunsch:	<i>Options:</i>			
ERAGONmodular	ERAGONmodular			
Greifzange, schlank 5 mm	Grasping forceps, tapered 5 mm	<b>83932897</b>	BDE 52	1
Greif- und Präparierzange 5 mm	Grasping and dissecting forceps 5 mm	<b>83931837</b>	BDE 54	1
Probe-Exzisionszange 5 mm	Biopsy forceps 5 mm	<b>83930917</b>	BDE 65	1
Greif-Dissektionszange "Maryland" 10 mm	Grasping forceps "Maryland" 10 mm	<b>83952257</b>	BDE 129	1
Clip-Applikator 10 mm	Clip-applicator 10 mm	<b>8389.911</b>	BDE 105	1
Ligaclips, VE=108 Stück	Ligaclips, PACK=108 PCS	<b>8389.915</b>	BDE 105	1
Einführungshülse	Insertion sleeve	<b>8389.991</b>	BDE 105	1
Nadelhalter 5 mm	Needle holder 5 mm	<b>8393.502</b>	BDE 110	1

## Basic Set KeyPort

the reusable Single-Port Solution

## Basis-Set KeyPort

the reusable Single-Port Solution

Artikel	Article	Typen / Types	Seite / Page	Stk. / pcs.
PANOVIEW PLUS-Optik 5,7 mm, 30°	PANOVIEW PLUS telescope 5.7 mm, 30°	<b>89354425</b>	BDE 135	1
und/oder	and/or			
PANOVIEW PLUS-Optik 5,7 mm, 0°	PANOVIEW PLUS telescope 5.7 mm, 0°	<b>89354415</b>	BDE 135	1
Fiber Lichtleiter	Fiber light cable	<b>8062.451</b>	BDE 135	1
Aufbereitungskorb	Reprocessing basket	<b>38022.111</b>	BDE 135	1
KeyPort Trokar, Durchlass 21 mm	KeyPort trocar sleeve, 21 mm passage	<b>885020</b>	BDE 140	1
hierzu:	also:			
KeyPort Trokar	KeyPort trocar	<b>885021</b>	BDE 140	1
und/oder	and/or			
KeyPort Trokar, Durchlass 24 mm	KeyPort trocar sleeve, 24 mm passage	<b>885030</b>	BDE 140	1
hierzu:	also:			
KeyPort Trokar	KeyPort trocar	<b>885031</b>	BDE 140	1
KeyPort Silikon-Dichteinsatz	KeyPort silicone seal insert	<b>88502431</b>	BDE 141	1
Inline Dissektor "Maryland" 5,8 mm	InLine Dissector "Maryland" 5.8 mm	<b>83994012</b>	BDE 142	1
Inline Fassungszange, atraumatisch, 5,8 mm	InLine holding forceps, atraumatic, 5.8 mm	<b>83994011</b>	BDE 142	1
Inline Dissektor "Mixer" 5,8 mm	InLine Dissector "Mixer" Ø 5.8 mm	<b>83994010</b>	BDE 142	1
Inline Schere "Metzenbaum" 5,8 mm	InLine scissors "Metzenbaum" 5.8 mm	<b>83994013</b>	BDE 142	1
DuoRotate Dissektor "Maryland", 5,8 mm	DuoRotate Dissector "Maryland", 5.8 mm	<b>83993012</b>	BDE 142	1
DuoRotate Fassungszange, atraumatisch, 5,8 mm	DuoRotate holding forceps, atraumatic, 5.8 mm	<b>83993011</b>	BDE 142	1
DuoRotate Dissektor "Mixer", 5,8 mm	DuoRotate Dissector "Mixer", 5.8 mm	<b>83993010</b>	BDE 142	1
DuoRotate Schere "Metzenbaum", 5,8 mm	DuoRotate scissors "Metzenbaum", 5.8 mm	<b>83993013</b>	BDE 142	1
ERAGONmodular	ERAGONmodular			
Atraumatische Greifzange, Ø 5 mm	Atraumatic grasping forceps, Ø 5 mm	<b>83941817</b>	BDE 53	1
Greif- und Dissektionszange, Ø 5 mm	Grasping and dissecting forceps, Ø 5 mm	<b>83942817</b>	BDE 124	1
Schere, "Metzenbaum", Ø 5 mm	Scissors "Metzenbaum", Ø 5 mm	<b>83940417</b>	BDE 126	1
Haken-Elektrode, Ø 5 mm	Hook electrode, Ø 5 mm	<b>8384.423</b>	BDE 131	1
HF-Anschlusskabel	HF connecting cable	<b>8106</b>	BDE 163	1
optional:				
Clip-Applikator, 10 mm, WL 340 mm	Clip-Applicator, 10 mm, NL 340 mm	<b>8389.911</b>	BDE 137	1
Ligaclips, VE=108 Stück	Ligaclips, PACK=108 PCS	<b>8389.915</b>	BDE 137	1

## Basic Set KeyPort<sup>flex</sup>

## Basis-Set KeyPort<sup>flex</sup>

Artikel	Article	Typen / Types	Seite / Page	Stk. / pcs.
PANOVIEW PLUS-Optik 5,7 mm, 30°	PANOVIEW PLUS telescope 5.7 mm, 30°	<b>89354425</b>	BDE 135	<b>1</b>
Aufbereitungskorb	Reprocessing basket	<b>38022.111</b>	BDE 135	<b>1</b>
Spülschiff für PANOVIEW Optik	Rinsing sheath for telescope	<b>893544255</b>	BDE 135	<b>1</b>
Fiber Lichtleiter, 90° abgewinkelt	Fiber light cable, angled 90° distally	<b>8062.451</b>	BDE 135	<b>1</b>
<b>KeyPort flex Set</b>	<b>KeyPort flex Set</b>			
(2 Luer) - enthält alle Komponenten	(2 Luer) - contains all components	<b>8850601</b>	BDE 136	<b>1</b>
optional:	optional:			
<b>KeyPort flex TEM Set (zur Verwendung mit TEM-Kombinations-System 2232.201)</b>	<b>KeyPort flex TEM Set (for use with TEM combinations system 2232.201)</b>	<b>8850602</b>	BDE 138	<b>1</b>
<b>ERAGONmodular</b>	<b>ERAGONmodular</b>			
HF-Kombinations-Pinzette, rechts gebogen 5 mm	HF multifunction forceps, curved right 5 mm	<b>83946217</b>	TEM	<b>1</b>
optional:	optional:			
HF-Kombinations-Pinzette, links gebogen 5 mm	HF multifunction forceps, curved left 5 mm	<b>83946227</b>	TEM	<b>1</b>
Schere, "Metzenbaum" 5 mm	Scissors "Metzenbaum" 5 mm	<b>83940417</b>	BDE 74	<b>1</b>
HF-Messer, rechts, 4 mm	HF knife, right, 4 mm	<b>8840.711</b>	TEM	<b>1</b>
optional:	optional:			
HF-Messer, links, 4 mm	HF knife, left, 4 mm	<b>8840.712</b>	TEM	<b>1</b>
DuoRotate / InLine "Fasszange" 5,8 mm	DuoRotate / InLine "Grasping forceps" 5.8 mm	<b>83993011</b>	BDE 179	<b>1</b>
Koagulations-Saugrohr 6 mm	Coagulation suction tube 6 mm	<b>8840.731</b>	TEM	<b>1</b>
Nadelhalter, 4,6 mm	Needle holder, 4.6 mm	<b>8840.605</b>	TEM	<b>1</b>
TEM Clip Applikator-Set	TEM Clip Applicator Set	<b>8840.7621</b>	TEM	<b>1</b>
Nahtklammen	Suture Staples	<b>8840.764</b>	TEM	<b>1</b>

## Basic Set LEVD

### Laparo-Endoscopic Varicocele Dissection in Single-Port Technique

## Basis-Set LEVD

### Laparoskopische Einkanal Varikozelen-Dissektion

Artikel	Article	Typen / Types	Seite / Page	Stk. / pcs.
Operations-Laparoskop 5,5 mm , 0°	<i>Operating laparoscope 5.5 mm, 0°</i>	<b>8920.4011</b>	BDE 14	1
Aufbereitungskorb	<i>Reprocessing basket</i>	<b>38044.211</b>	BDE 14	1
Fiber Lichtleiter	<i>Fiber light cable</i>	<b>806625231</b>	BDE 14	1
Selbsthaltende Kunststofftrokarhülse 5,5 mm	<i>Self-retaining plastic trocar sleeve 5.5 mm</i>	<b>8919.353</b>	BDE 32	1
hierzu:	<i>also:</i>			
Trokar, kegelig stumpf	<i>Trocar, conical with blunt tip</i>	<b>8919.3511</b>	BDE 32	1
Trokar, kegelig spitz	<i>Trocar, with sharp tip</i>	<b>8919.3512</b>	BDE 32	1
Trokar, Spitze dreikantig	<i>Trocar, with pyramid-shaped tip</i>	<b>8919.3513</b>	BDE 32	1
ERAGONmodular mini	<i>ERAGONmodular mini</i>			
Universal-Greifzange 3,5 mm	<i>Universal grasping forceps 3.5 mm</i>	<b>83912097</b>	BDE 59	1
Atraumatische Greifzange 3,5 mm	<i>Atraumatic grasping forceps 3.5 mm</i>	<b>83912087</b>	BDE 57	1
Greifzange "Babcock" 3,5 mm	<i>Grasping forceps "Babcock", 3.5 mm</i>	<b>83912107</b>	BDE 59	1
Greif- und Dissektionszange 3,5 mm	<i>Grasping and dissecting forceps 3.5 mm</i>	<b>83912077</b>	BDE 56	1
Hakenschere	<i>Hook scissors</i>	<b>83912277</b>	BDE 91	1
Schere "Metzenbaum"	<i>Scissors "Metzenbaum"</i>	<b>83912247</b>	BDE 91	1
HF-Kabel Bipolar	<i>HF-connecting cable bipolar</i>	<b>8108</b>	BDE 164	1
HF-Kabel Monopolar	<i>HF-connecting cable monopolar</i>	<b>8106</b>	BDE 163	1

1

## Mini Fibre Telescopes 2 mm

## Mini-Fiber-Optiken 2 mm

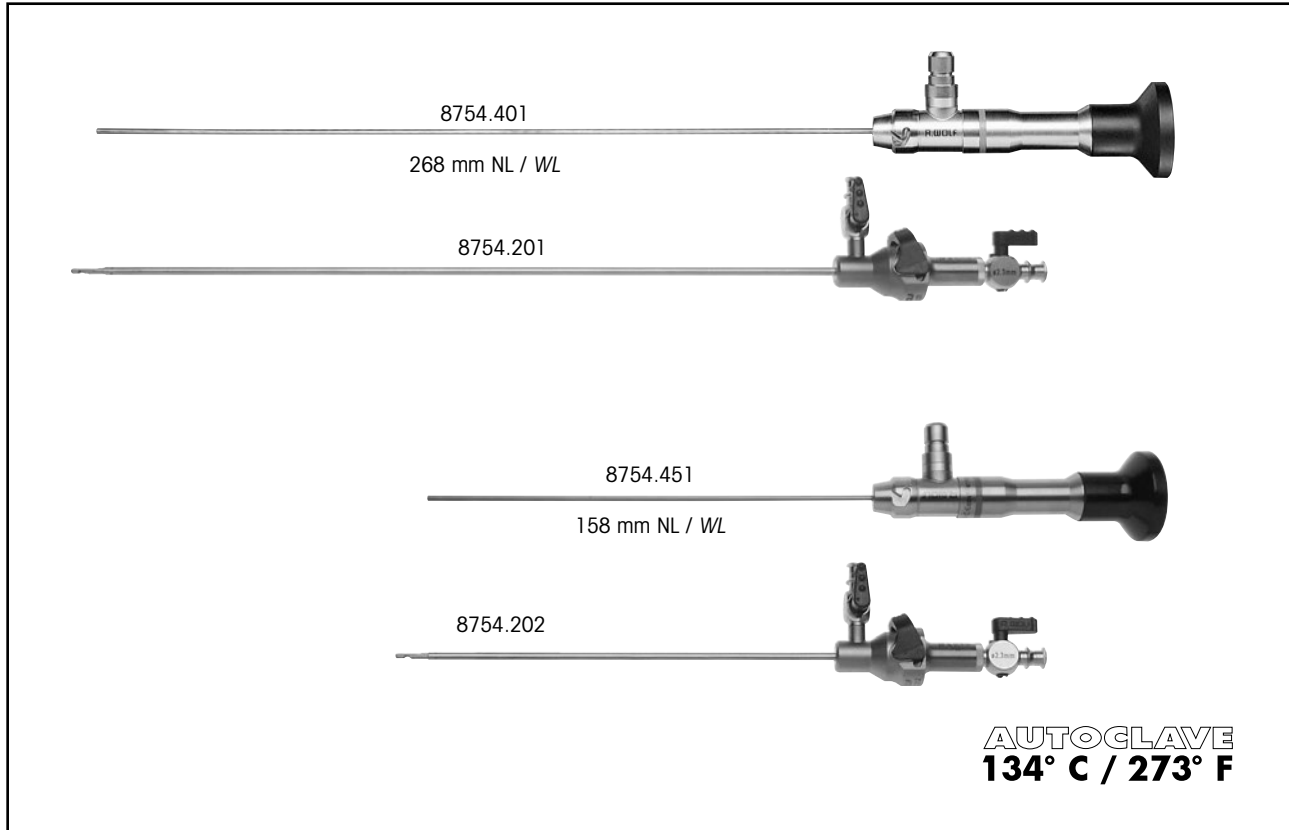

### WL 268 mm standard version

Telescope, Ø 2 mm, 0° .....	8754.401
VERES needle (8754.211), Ø 2.3 mm with outer sheath (8754.221) .....	8754.201

### WL 158 mm short version

Telescope, Ø 2 mm, 0° .....	8754.451
VERES needle (8754.212), Ø 2.3 mm with outer sheath (8754.222) .....	8754.202

### NL 268 mm Standard-Ausführung

Optik, Ø 2 mm, 0° .....	8754.401
VERES-Kanüle (8754.211), Ø 2,3 mm mit Außenschäft (8754.221) .....	8754.201

### NL 158 mm Kurze Ausführung

Optik, Ø 2 mm, 0° .....	8754.451
VERES-Kanüle (8754.212), Ø 2,3 mm mit Außenschäft (8754.222) .....	8754.202

#### Recommended light cable:

**Fiber light cable set** Ø 2.5 mm, 2.3 m long consisting of:  
Fiber light cable (80662523), adapter projector side (8095.07) and  
adapter endoscope side (809509) ..... 806625231  
(for maximum light transmission)

#### Accessories:

<b>Reprocessing basket</b> (for telescope 8754.451) (L x W x H) 287 x 59 x 54 mm .....	38020.111
<b>Reprocessing basket</b> (for telescope 8754.401) (L x W x H) 471 x 59 x 54 mm .....	38021.111

#### Empfohlene Lichtleiter:

**Fiber Lichtleiter Set**, Ø 2,5 mm, 2,3 m lang bestehend aus:  
Fiber Lichtleiter (80662523), Adapter projektorseitig (8095.07) und  
Adapter endoskopseitig (809509)..... 806625231  
(für maximale Lichttransmission)

#### Zubehör:

<b>Aufbereitungskorb</b> (für Optik 8754.451) (L x B x H) 287 x 59 x 54 mm .....	38020.111
<b>Aufbereitungskorb</b> (für Optik 8754.401) (L x B x H) 471 x 59 x 54 mm .....	38021.111

## Laparoscopes 3.5 mm

## Laparoskope 3,5 mm

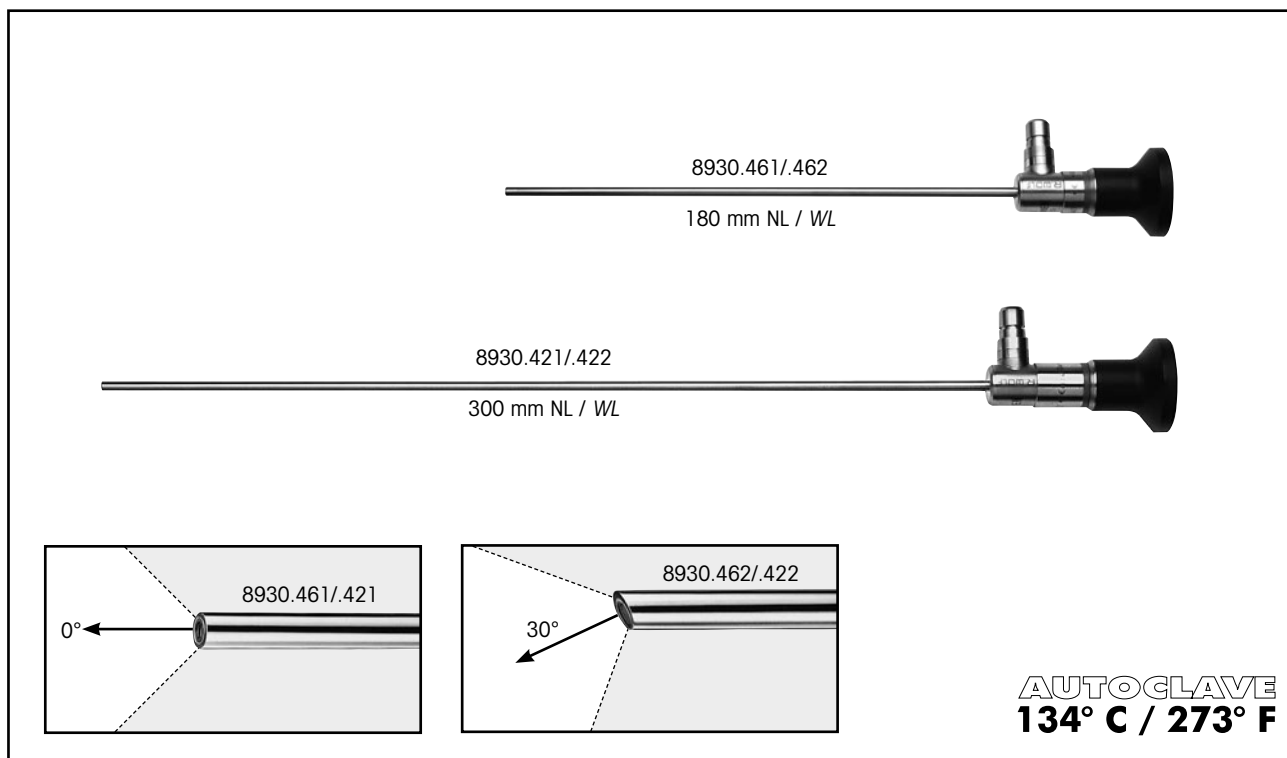

2

### WL 180 mm

**PANOVIEW PLUS telescope, Ø 3.5 mm,**

0° .....	8930.461
30° .....	8930.462

### WL 300 mm

**PANOVIEW PLUS telescope, Ø 3.5 mm,**

0° .....	8930.421
30° .....	8930.422

### NL 180 mm

**PANOVIEW PLUS-Optik, Ø 3,5 mm,**

0° .....	8930.461
30° .....	8930.462

### NL 300 mm

**PANOVIEW PLUS-Optik, Ø 3,5 mm,**

0° .....	8930.421
30° .....	8930.422

### Recommended light cable:

**Fiber light cable set** Ø 2.5 mm, 2.3 m long consisting of:

Fiber light cable (80662523), adapter projector side (8095.07) and adapter endoscope side (809509) ..... 806625231  
(for maximum light transmission)

### Accessories:

**Reprocessing basket** (for telescope 8930.461 / .462)  
(L x W x H) 287 x 59 x 54 mm ..... 38020.111

**Reprocessing basket** (for telescope 8930.421 / .422)  
(L x W x H) 471 x 59 x 54 mm ..... 38021.111

### Empfohlene Lichtleiter:

**Fiber Lichtleiter Set**, Ø 2,5 mm, 2,3 m lang bestehend aus:

Fiber Lichtleiter (80662523), Adapter projektorseitig (8095.07) und Adapter endoskopseitig (809509) ..... 806625231  
(für maximale Lichttransmission)

### Zubehör:

**Aufbereitungskorb** (für Optik 8930.461 / .462)  
(L x B x H) 287 x 59 x 54 mm ..... 38020.111

**Aufbereitungskorb** (für Optik 8930.421 / .422)  
(L x B x H) 471 x 59 x 54 mm ..... 38021.111

## Laparoscopes 5.3 mm

# distortion-free

## Laparoskope 5,3 mm

# verzeichnungsfrei

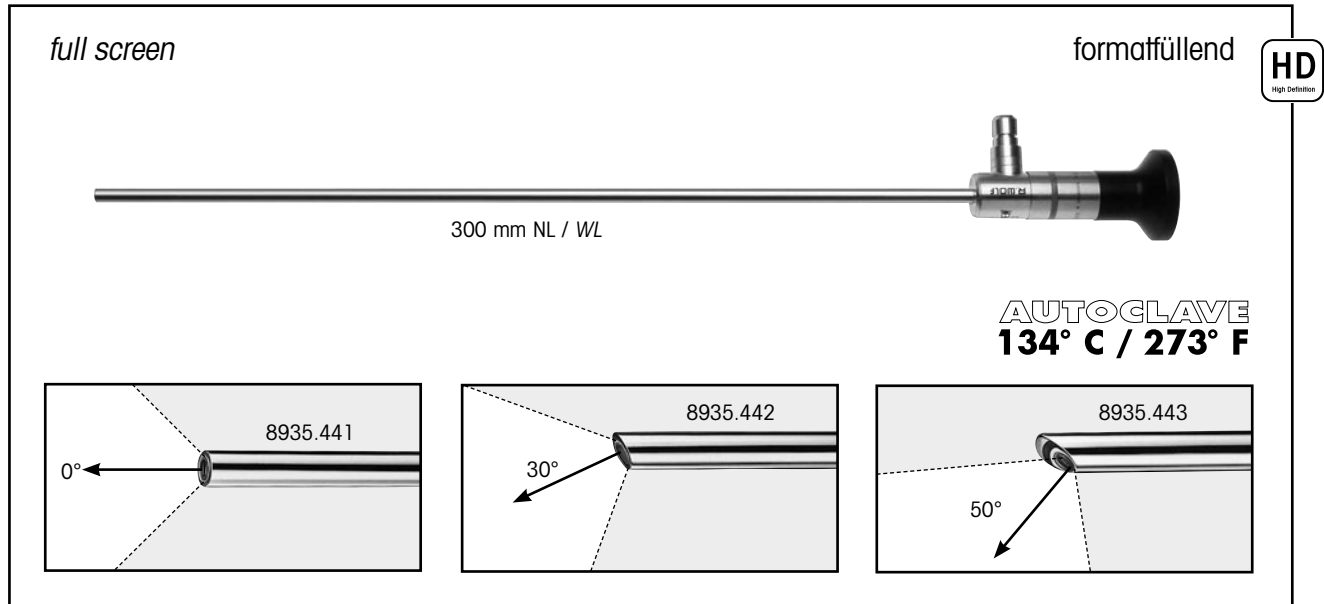

**PANOVIEW telescope, Ø 5.3 mm,  
distortion-free, full screen,**

0° .....	8935.441
30° .....	8935.442
50° .....	8935.443

**PANOVIEW-Optik, Ø 5,3 mm,  
verzeichnungsfrei, formatfüllend**

0° .....	8935.441
30° .....	8935.442
50° .....	8935.443

Recommended light cable:

**Fiber light cable set** Ø 3.5 mm, 2.3 m long consisting of:  
Fiber light cable (80663523), adapter projector side (8095.07) and  
adapter endoscope side (809509) ..... 806635231  
(for maximum light transmission)

Empfohlene Lichtleiter:

**Fiber Lichtleiter Set**, Ø 3,5 mm, 2,3 m lang bestehend aus:  
Fiber Lichtleiter (80663523), Adapter projektorseitig (8095.07) und  
Adapter endoskopseitig (809509) ..... 806635231  
(für maximale Lichttransmission)

Accessories:

**Reprocessing basket**  
(L x W x H) 471 x 59 x 54 mm ..... 38021.111

Zubehör:

**Aufbereitungskorb**  
(L x B x H) 471 x 59 x 54 mm ..... 38021.111



**Laparoscope 5.3 mm**  
# distortion-free, long version

**Laparoskope 5,3 mm**  
# verzeichnungsfrei, lange Ausführung

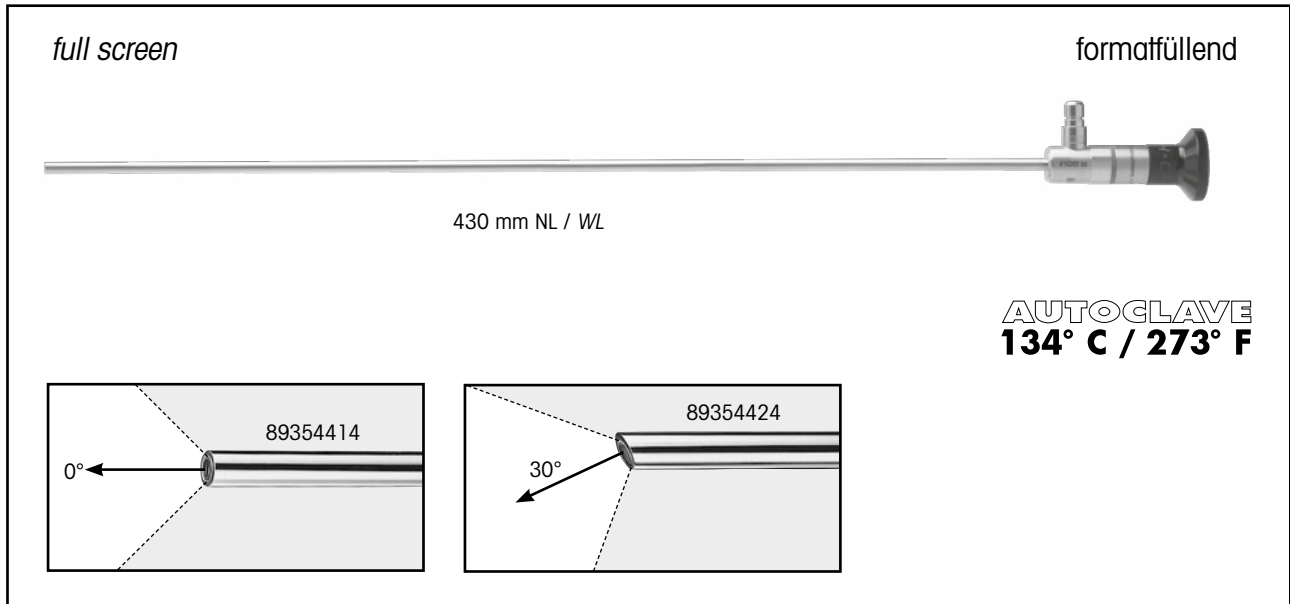

2

**PANOVIEW telescope, Ø 5.3 mm,**  
**distortion-free, full screen,**

0° .....	89354414
30° .....	89354424

**PANOVIEW-Optik, Ø 5,3 mm,**  
**verzeichnungsfrei, formatfüllend**

0° .....	89354414
30° .....	89354424

*Recommended light cable:*

**Fiber light cable set** Ø 3.5 mm, 2.3 m long consisting of:

Fiber light cable (80663523), adapter projector side (8095.07) and adapter endoscope side (809509) ..... 806635231  
(for maximum light transmission)

*Empfohlene Lichtleiter:*

**Fiber Lichtleiter Set**, Ø 3,5 mm, 2,3 m lang bestehend aus:

Fiber Lichtleiter (80663523), Adapter projektorseitig (8095.07) und Adapter endoskopseitig (809509) ..... 806635231  
(für maximale Lichttransmission)

*Recommended light cable*

*for Single Port Surgery (KeyPort):*

**Fiber light cable**, Ø 3.5 mm, 2.3 m long

angled 90° distally ..... 8062.351  
(for maximum light transmission)

*Empfohlene Lichtleiter*

*für die Single Port Chirurgie (KeyPort):*

**Fiber-Lichtleiter**, Ø 3,5 mm, 2,3 m lang

distal 90° abgewinkelt ..... 8062.351  
(für maximale Lichttransmission)

*Accessories:*

**Reprocessing basket**

(L x W x H) 610 x 59 x 54 mm ..... 38022.111

*Zubehör:*

**Aufbereitungskorb**

(L x B x H) 610 x 59 x 54 mm ..... 38022.111

**Mini-Operating-Laparoscope**  
5.5 mm with 3.5 mm Working Channel

**Mini-OP-Laparoskop**  
5,5 mm mit 3,5 mm Arbeitskanal

2

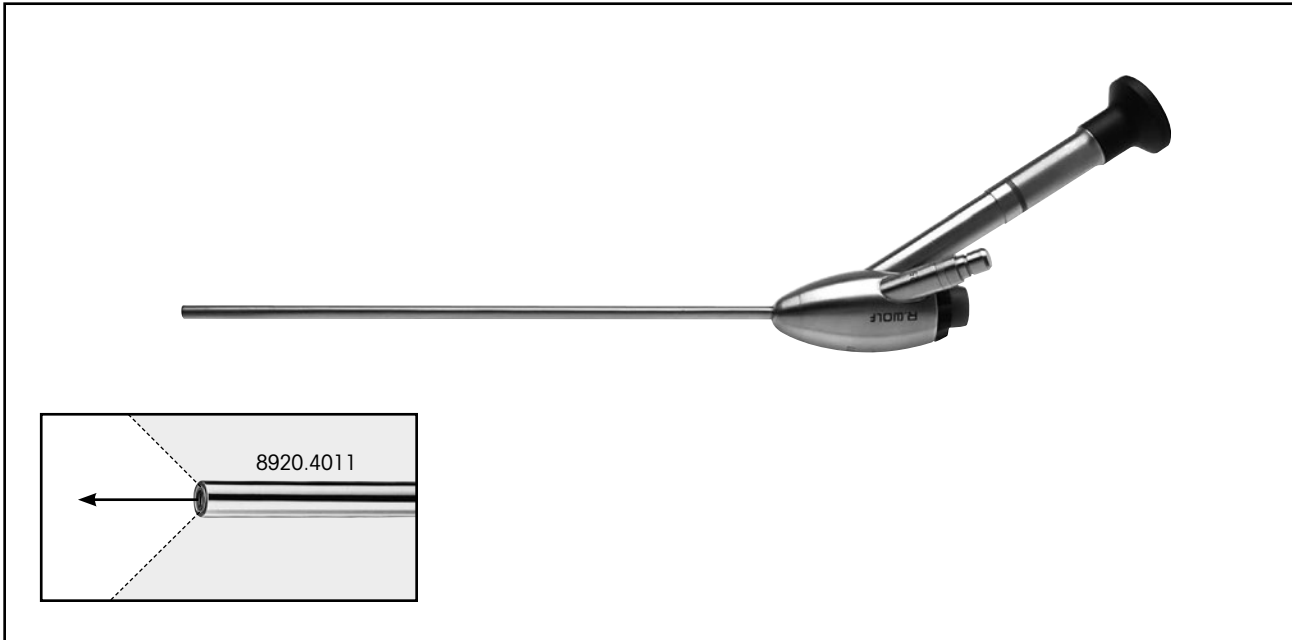

**OP Endoscope bundle**, Ø 5.3 mm, SL 215 mm  
consisting of:  
OP endoscope with 3.5 mm working channel, silicate image guide (8920.401), sealing element (8920.311), sealing cap (15176.020),  
0° ..... 8920.4011

**Spare membrane valves**, yellow, PACK=10 PCS ..... 89.103

Recommended light cable:

**Fiber light cable set** Ø 2.5 mm, 2.3 m long consisting of:  
Fiber light cable (80662523), adapter projector side (8095.07) and adapter endoscope side (809509) ..... 806625231  
(for maximum light transmission)

The trocar sleeves 8919.333 / .353 see page BDE 32 with optimised working length are recommended.

**OP-Endoskop komplett**, Ø 5.3 mm, SL 215 mm  
bestehend aus:  
OP-Endoskop mit 3,5 mm Arbeitskanal, Silikat-Bildleiter (8920.401), Dichtungsteil (8920.311), Dichtungskappe (15176.020),  
0° ..... 8920.4011

**Ersatz-Membran-Ventil**, gelb, VE=10 ST ..... 89.103

Empfohlene Lichtleiter:

**Fiber Lichtleiter Set**, Ø 2,5 mm, 2,3 m lang bestehend aus:  
Fiber Lichtleiter (80662523), Adapter projektorseitig (8095.07) und Adapter endoskopseitig (809509) ..... 806625231  
(für maximale Lichttransmission)

Empfohlen werden die in der Nutzlänge optimierten Trokarhülsen 8919.333 / .353 siehe Seite BDE 32.

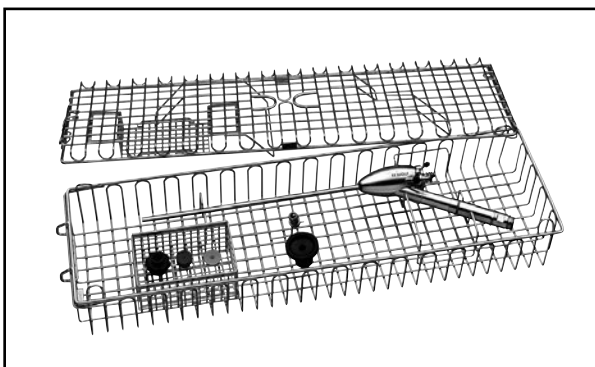

**Aufbereitungskorb** für OP-Endoskop (8920.4011)  
Maße (B x L x H): 131,5 x 471,5 x 74 mm ..... 38044.211

**Reprocessing basket** for OP endoscope (8920.4011)  
Dimensions (W x L x H): 131.5 x 471.5 x 74 mm ..... 38044.211

Telescopes 5.5 mm  
optimized for 4K UHD

Optiken 5,5 mm  
optimiert für 4K UHD

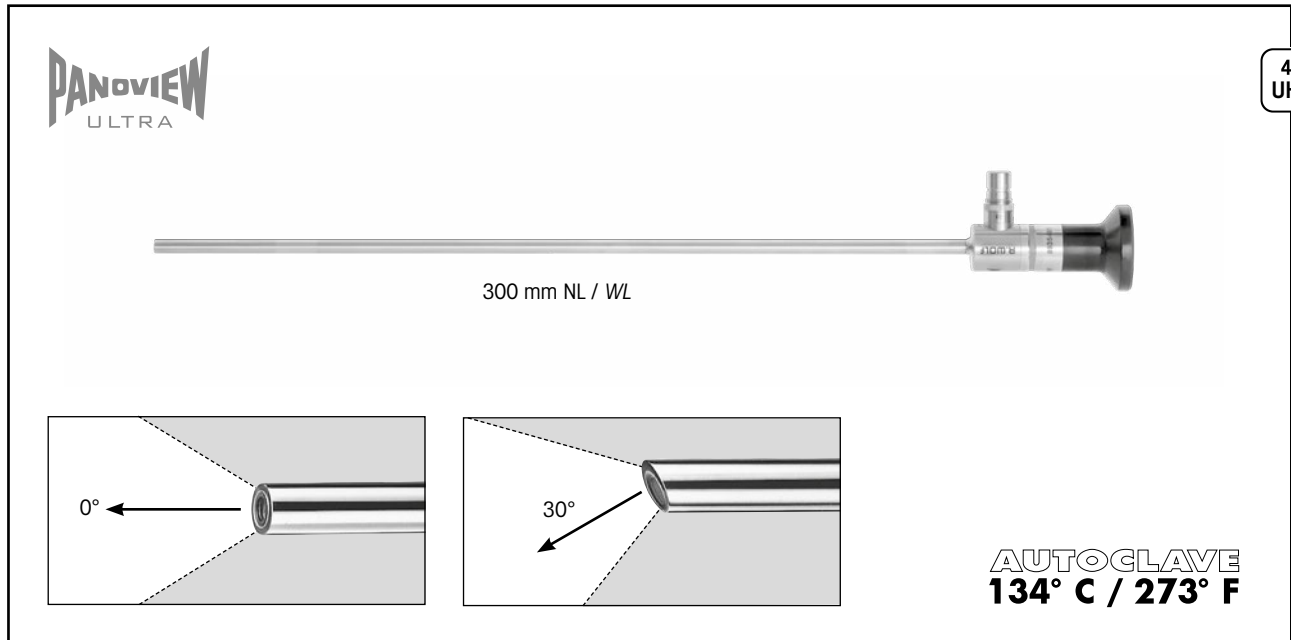

**PANOVIEW ULTRA telescope, Ø 5.5 mm**

0° .....	8935461
30° .....	8935462

**PANOVIEW ULTRA-Optik, Ø 5,5 mm**

0° .....	8935461
30° .....	8935462

*Recommended light cable:*

**Fiber light cable bundle,**

Ø 5.0 mm, 2.3 m long consisting of:

Fiber light cable (80665023),

adapter on the projector side (8095.07) and

adapter on the endoscope side (809509) ..... 806650231

**Fusion fiber light cable bundle,**

Ø 5.0 mm, 2.3 m long consisting of:

Fusion fiber light cable (80655023),

adapter on the projector side (8095.07) and

adapter on the endoscope side (809509) ..... 806550231

*Accessories:*

**Reprocessing basket**

(L x W x H) 471 x 59 x 54 mm ..... 38021.111

*Empfohlene Lichtleiter:*

**Fiber Lichtleiter komplett,**

Ø 5,0 mm, 2,3 m lang bestehend aus:

Fiber Lichtleiter (80665023),

Adapter projektorseitig (8095.07) und

Adapter endoskopseitig (809509) ..... 806650231

**Fusion Fiber Lichtleiter komplett,**

Ø 5,0 mm, 2,3 m lang bestehend aus:

Fusion Fiber Lichtleiter (80655023),

Adapter projektorseitig (8095.07) und

Adapter endoskopseitig (809509) ..... 806550231

*Zubehör:*

**Aufbereitungskorb**

(L x B x H) 471 x 59 x 54 mm .....38021.111

**Telescopes 5.5 mm**  
*optimized for 4K UHD*  
*long version*

**Optiken 5,5 mm**  
*optimiert für 4K UHD*  
*lange Ausführung*

2

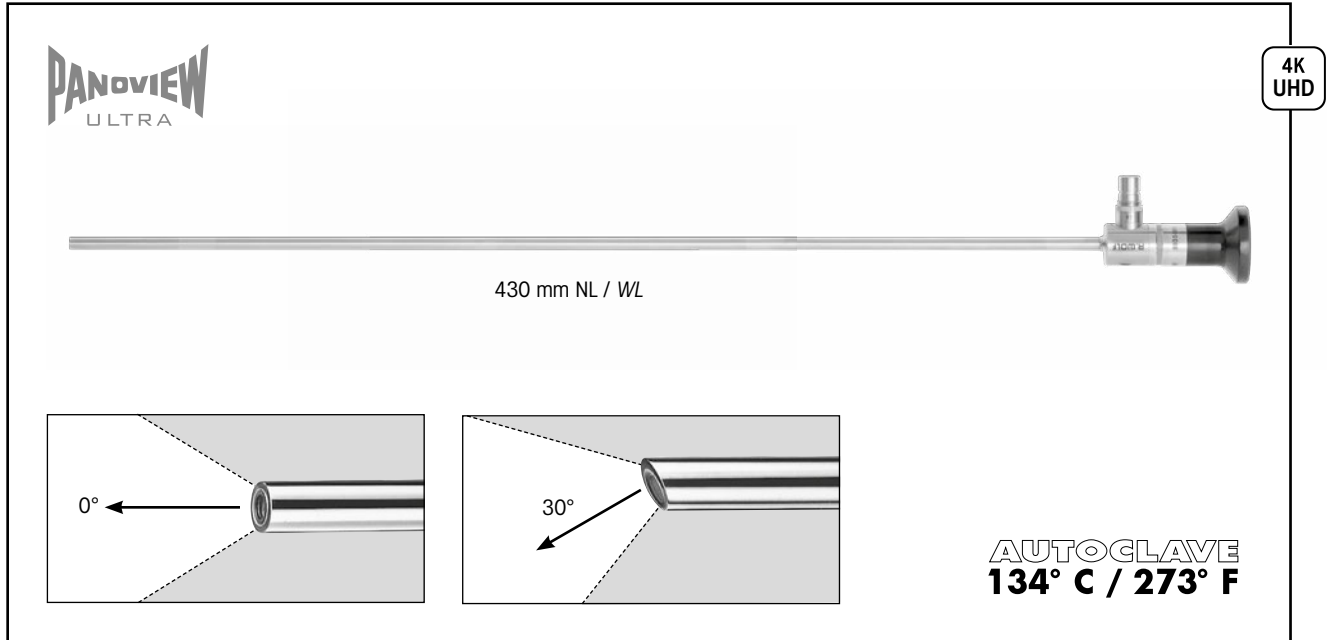

**PANOVIEW ULTRA telescope, Ø 5.5 mm**

0° .....	89354416
30° .....	89354426

**PANOVIEW ULTRA-Optik, Ø 5,5 mm**

0° .....	89354416
30° .....	89354426

*Recommended light cable:*

**Fiber light cable bundle,**

Ø 5.0 mm, 2.3 m long consisting of:

Fiber light cable (80665023),

adapter on the projector side (8095.07) and

adapter on the endoscope side (809509) ..... 806650231

**Fusion fiber light cable bundle, Ø 5.0 mm, 2.3 m long**  
 consisting of:

Fusion fiber light cable (80655023),

adapter on the projector side (8095.07) and

adapter on the endoscope side (809509) ..... 806550231

*Accessories:*

**Reprocessing basket**

(L x W x H) 610 x 59 x 54 mm ..... 38022.111

*Empfohlene Lichtleiter:*

**Fiber Lichtleiter komplett,**

Ø 5.0 mm, 2,3 m lang bestehend aus:

Fiber Lichtleiter (80665023),

Adapter projektorseitig (8095.07) und

Adapter endoskopseitig (809509) ..... 806650231

**Fusion Fiber Lichtleiter komplett, Ø 5,0 mm, 2,3 m lang**  
 bestehend aus:

Fusion Fiber Lichtleiter (80655023),

Adapter projektorseitig (8095.07) und

Adapter endoskopseitig (809509) ..... 806550231

*Zubehör:*

**Aufbereitungskorb**

(L x B x H) 610 x 59 x 54 mm ..... 38022.111

## Laparoscopes 5.7 mm

# distortion-free

## Laparoskope 5,7 mm

# verzeichnungsfrei

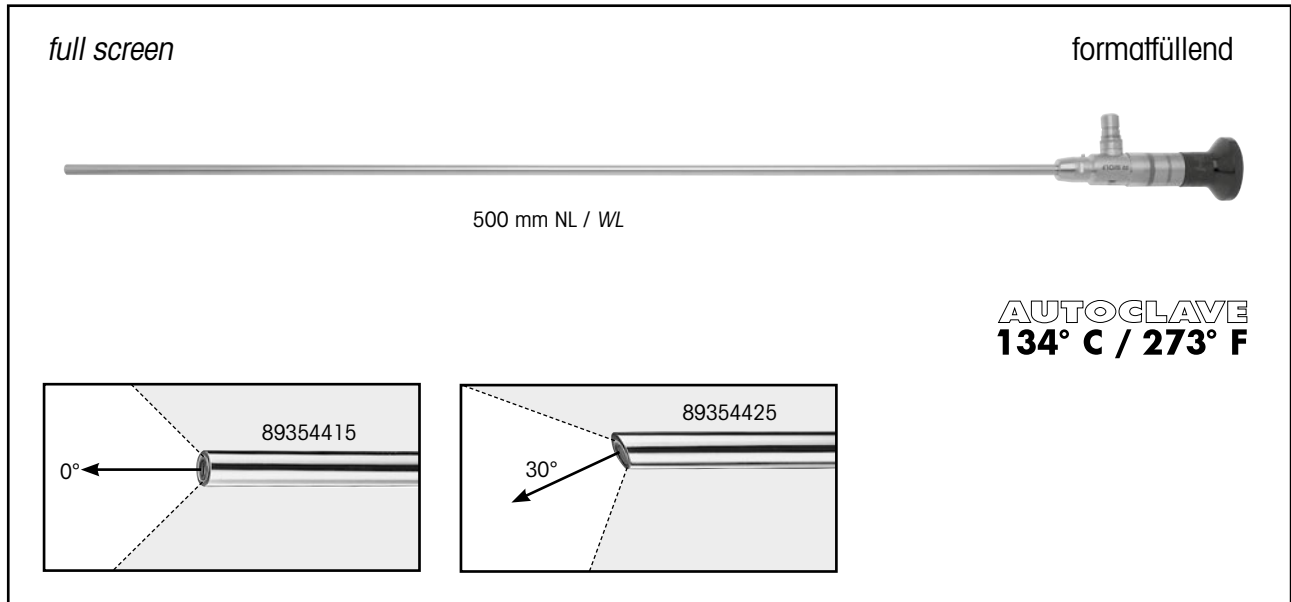

**PANOVUE telescope, Ø 5.7 mm,  
distortion-free, full screen,**

0° .....	89354415
30° .....	89354425

**PANOVUE Optik, Ø 5,7 mm,  
verzeichnungsfrei, formatfüllend,**

0° .....	89354415
30° .....	89354425

Recommended light cable:

**Fiber light cable set** Ø 5.0 mm, 2.3 m long consisting of:

Fiber light cable (80665023), adapter projector side (8095.07) and  
adapter endoscope side (809509) ..... 806650231  
(for maximum light transmission)

**Fiber light cable set *Fusion***, high-temperature resistant,  
Ø 5.0 mm, 2.3 m long consisting of:

Fiber light cable (80655023), adapter projector side (8095.07) and  
adapter endoscope side (809509) ..... 806550231  
(for maximum light transmission)

Recommended light cable

for Single Port Surgery (KeyPort):

**Fiber light cable**, Ø 4.5 mm, 2.3 m long  
angled 90° distally ..... 8062.451  
(for maximum light transmission)

Accessories:

**Reprocessing basket**

(L x W x H) 610 x 59 x 54 mm ..... 38022.111

Empfohlene Lichtleitkabel:

**Fiber Lichtleiter Set**, Ø 5,0 mm, 2,3 m lang bestehend aus:

Fiber Lichtleiter (80665023), Adapter projektorseitig (8095.07) und  
Adapter endoskopseitig (809509) ..... 806650231  
(für maximale Lichttransmission)

**Fiber Lichtleiter Set *Fusion***, hochtemperaturbeständig,  
Ø 5,0 mm, 2,3 m lang bestehend aus:

Fiber Lichtleiter (80655023), Adapter projektorseitig (8095.07) und  
Adapter endoskopseitig (809509) ..... 806550231  
(für maximale Lichttransmission)

Empfohlene Lichtleiter

für die Single Port Chirurgie (KeyPort):

**Fiber-Lichtleiter**, Ø 4,5 mm, 2,3 m lang  
distal 90° abgewinkelt ..... 8062.451  
(für maximale Lichttransmission)

Zubehör:

**Aufbereitungskorb**

(L x B x H) 610 x 59 x 54 mm ..... 38022.111

## Laparoscopes 10 mm

# distortion-free

## Laparoskope 10 mm

# verzeichnungsfrei

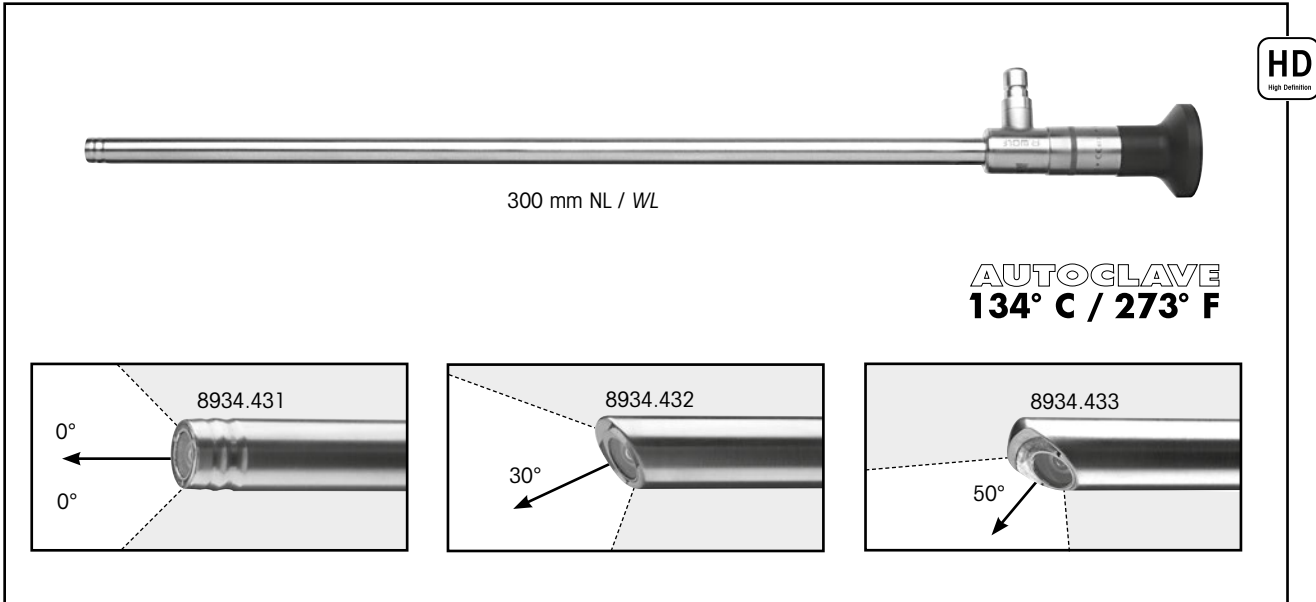

**PANOVIEW telescope, Ø 10 mm, distortion-free,**

0° .....	8934.431
30° .....	8934.432
50° .....	8934.433

**PANOVIEW-Optik, Ø 10 mm, verzeichnungsfrei,**

0° .....	8934.431
30° .....	8934.432
50° .....	8934.433

Recommended light cable:

**Fiber light cable set** Ø 5.0 mm, 2.3 m long consisting of:  
Fiber light cable (80665023), adapter projector side (8095.07) and  
adapter endoscope side (809509) ..... 806650231  
(for maximum light transmission)

**Fiber light cable set -fusion-**, high-temperature resistant,  
Ø 5.0 mm, 2.3 m long consisting of:  
Fiber light cable (80665023), adapter projector side (8095.07) and  
adapter endoscope side (809509) ..... 806650231  
(for maximum light transmission)

Accessories:

**Reprocessing basket**  
(L x W x H) 471 x 59 x 54 mm ..... 38021.111

Empfohlene Lichtleiter:

**Fiber Lichtleiter Set**, Ø 5,0 mm, 2,3 m lang bestehend aus:  
Fiber Lichtleiter (80665023), Adapter projektorseitig (8095.07) und  
Adapter endoskopseitig (809509) ..... 806650231  
(für maximale Lichttransmission)

**Fiber Lichtleiter Set -fusion-**, hochtemperaturbeständig,  
Ø 5,0 mm, 2,3 m lang bestehend aus:  
Fiber Lichtleiter (80665023), Adapter projektorseitig (8095.07) und  
Adapter endoskopseitig (809509) ..... 806650231  
(für maximale Lichttransmission)

Zubehör:

**Aufbereitungskorb**  
(L x B x H) 471 x 59 x 54 mm ..... 38021.111

Laparoscopes 10 mm  
long version, WL 430 mm

Laparoskope 10 mm  
Lange Ausführung, NL 430 mm

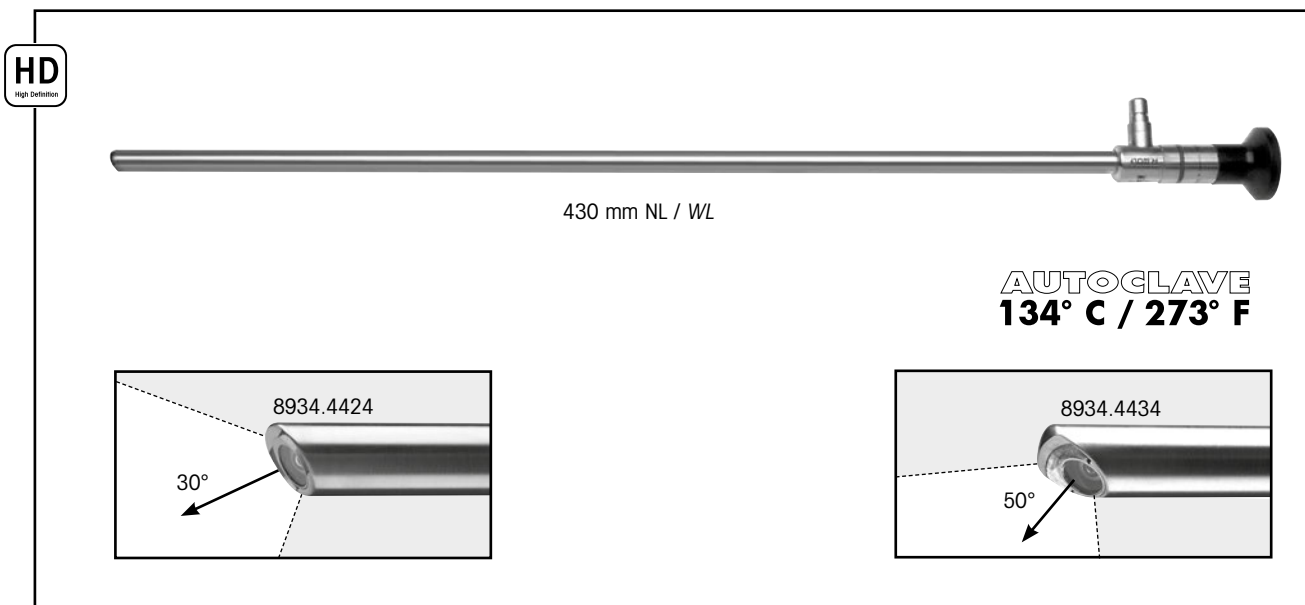

2

**PANOVIEW PLUS telescope, Ø 10 mm,**  
30° ..... 8934.4424  
50° ..... 8934.4434

**PANOVIEW PLUS-Optik, Ø 10 mm,**  
30° ..... 8934.4424  
50° ..... 8934.4434

*Recommended light cable:*

**Fiber light cable set** Ø 5.0 mm, 2.3 m long consisting of:  
Fiber light cable (80665023), adapter projector side (8095.07) and  
adapter endoscope side (809509) ..... 806650231  
(for maximum light transmission)

**Fiber light cable set** *Fusion*, high-temperature resistant,  
Ø 5.0 mm, 2.3 m long consisting of:  
Fiber light cable (80655023), adapter projector side (8095.07) and  
adapter endoscope side (809509) ..... 806550231  
(for maximum light transmission)

*Accessories:*

**Reprocessing basket**  
(L x W x H) 610 x 59 x 54 mm ..... 38022.111

*Empfohlene Lichtleitkabel:*

**Fiber Lichtleiter Set**, Ø 5,0 mm, 2,3 m lang bestehend aus:  
Fiber Lichtleiter (80665023), Adapter projektorseitig (8095.07) und  
Adapter endoskopseitig (809509) ..... 806650231  
(für maximale Lichttransmission)

**Fiber Lichtleiter Set** *Fusion*, hochtemperaturbeständig,  
Ø 5,0 mm, 2,3 m lang bestehend aus:  
Fiber Lichtleiter (80655023), Adapter projektorseitig (8095.07) und  
Adapter endoskopseitig (809509) ..... 806550231  
(für maximale Lichttransmission)

*Zubehör:*

**Aufbereitungskorb**  
(L x B x H) 610 x 59 x 54 mm ..... 38022.111

### 3D Endoscopes 10 mm

# distortion-free

### 3D Endoskop 10 mm

# verzeichnungsfrei

2

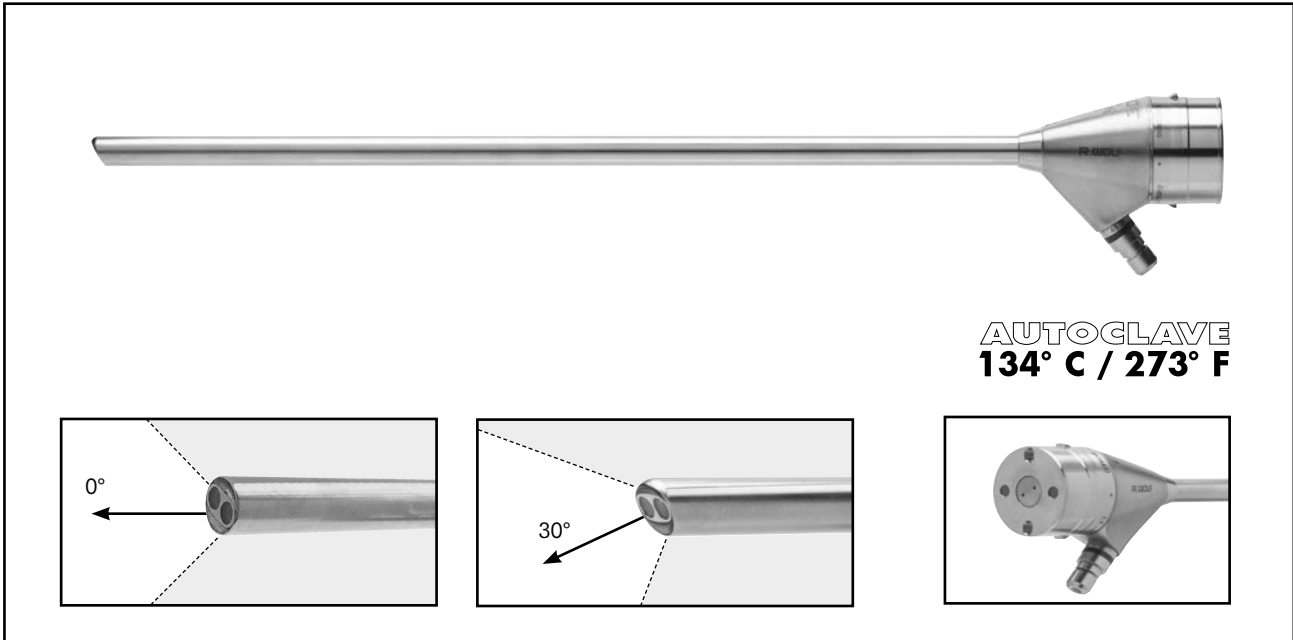

**3D endoscope bundle, Ø 10 mm, 0° Set, distortion-free,**  
 consisting of:  
 3DHD telescope (8934631), 300 mm WL  
 and Reprocessing basket (38023111) ..... 89346311  
 3DHD telescope (89344631), 430 mm WL  
 and Reprocessing basket (38023111) ..... 893446311

**3D endoscope bundle, Ø 10 mm, 30° Set, distortion-free,**  
 consisting of:  
 3DHD endoscope (8934632), 300 mm WL  
 and Reprocessing basket (38023111) ..... 89346321  
 3DHD telescope (89344632), 430 mm WL  
 and Reprocessing basket (38023111) ..... 893446321

Recommended light cable:  
**Fiber light cable set *Fusion***, high-temperature resistant,  
 Ø 5.0 mm, 2.3 m long consisting of:  
 Fiber light cable (80655023), adapter projector side (8095.07) and  
 adapter endoscope side (809509) ..... 806550231  
 (for maximum light transmission)

**3D Endoskop komplett, Ø 10 mm, 0° Set, verzeichnungsfrei,**  
 bestehend aus:  
 3DHD Optik (8934631), 300 mm NL  
 und Aufbereitungskorb (38023111) ..... 89346311  
 3DHD Opik (89344631), 430 mm NL  
 und Aufbereitungskorb (38023111) ..... 893446311

**3D Endoskop komplett, Ø 10 mm, 30° Set, verzeichnungsfrei,**  
 bestehend aus:  
 3D Endoskop (8934632), 300 mm NL  
 und Aufbereitungskorb (38023111) ..... 89346321  
 3DHD Endoskop (89344632), 430 mm NL  
 und Aufbereitungskorb (38023111) ..... 893446321

Empfohlene Lichtleiter:  
**Fiber Lichtleiter Set *Fusion***, hochtemperaturbeständig,  
 Ø 5,0 mm, 2,3 m lang bestehend aus:  
 Fiber Lichtleiter (80655023), Adapter projektorseitig (8095.07) und  
 Adapter endoskopseitig (809509) ..... 806550231  
 (für maximale Lichttransmission)

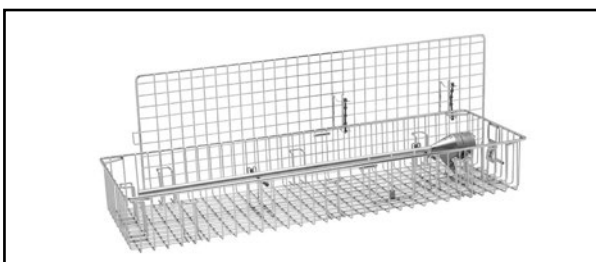

**Aufbereitungskorb** für 3DHD Endoskop  
 Maße (L x B x H): 582,5 x 200 x 80 mm ..... 38023111

**Reprocessing basket** for 3DHD telescope  
 Dimensions (L x W x H): 582,5 x 200 x 80 mm ..... 38023111



*Operating  
Laparoscope 10 mm*

**#** *distortion-free, with 5 mm working channel  
for one hole appendectomy*

**Operations-  
Laparoskop 10 mm**

**#** **verzeichnungsfrei, mit 5 mm Arbeitskanal  
für die One Hole Appendectomie**

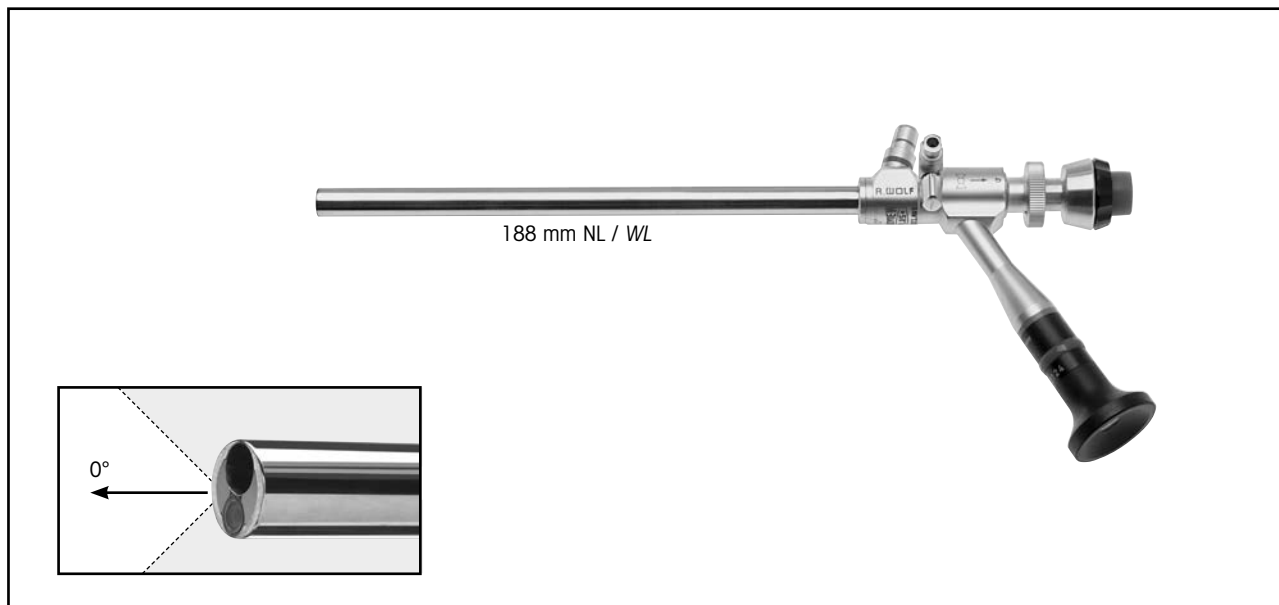

2

**PANOVUE PLUS OP endoscope, Ø 10 mm,**  
*with oblique eyepiece, working channel 5.1 mm,*  
0° ..... 8915.501

**PANOVUE PLUS-OP-Endoskop, Ø 10 mm,**  
*mit schrägem Okulareinblick, Arbeitskanal 5,1 mm,*  
0° ..... 8915.501

*Recommended light cable:*

**Fiber light cable set** Ø 5.0 mm, 2.3 m long consisting of:  
*Fiber light cable (80665023), adapter projector side (8095.07) and  
adapter endoscope side (809509)..... 806650231  
(for maximum light transmission)*

*Empfohlene Lichtleiter:*

**Fiber Lichtleiter Set, Ø 5,0 mm, 2,3 m lang bestehend aus:**  
*Fiber Lichtleiter (80665023), Adapter projektorseitig (8095.07) und  
Adapter endoskopseitig (809509)..... 806650231  
(für maximale Lichttransmission)*

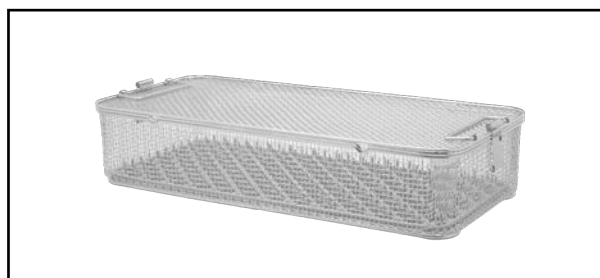

**Sterilisationskorb, niedrig,**

*inkl. Silikonmatte,  
Abmessung (B x H x T): 530 x 108 x 250 mm ..... 85844001*

**Sterilization basket, low**

*incl. silicone mat,  
dimensions (w x h x d): 530 x 108 x 250 mm ..... 85844001*

Telescopes 10 mm  
optimized for 4K UHD

Optiken 10 mm  
optimiert für 4K UHD

**PANOVIEW**  
ULTRA

4K  
UHD



305 mm NL / WL

**AUTOGLAVE**  
134° C / 273° F

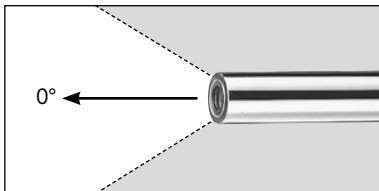

0°

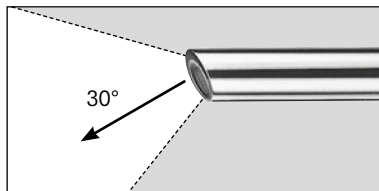

30°

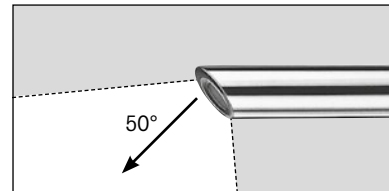

50°

**PANOVIEW ULTRA telescope, Ø 10 mm**

0° .....	8934461
30° .....	8934462
50° .....	8934463

**PANOVIEW ULTRA-Optik, Ø 10 mm**

0° .....	8934461
30° .....	8934462
50° .....	8934463

*Recommended light cable:*

**Fiber light cable bundle,**

Ø 5.0 mm, 2.3 m long consisting of:

Fiber light cable (80665023),

adapter on the projector side (8095.07) and

adapter on the endoscope side (809509) ..... 806650231

**Fusion fiber light cable bundle,**

Ø 5.0 mm, 2.3 m long consisting of:

Fusion fiber light cable (80655023),

adapter on the projector side (8095.07) and

adapter on the endoscope side (809509) ..... 806550231

*Accessories:*

**Reprocessing basket**

(L x W x H) 471 x 59 x 54 mm ..... 38021.111

*Empfohlene Lichtleiter:*

**Fiber Lichtleiter komplett,**

Ø 5,0 mm, 2,3 m lang bestehend aus:

Fiber Lichtleiter (80665023),

Adapter projektorseitig (8095.07) und

Adapter endoskopseitig (809509) ..... 806650231

**Fusion Fiber Lichtleiter komplett,**

Ø 5,0 mm, 2,3 m lang bestehend aus:

Fusion Fiber Lichtleiter (80655023),

Adapter projektorseitig (8095.07) und

Adapter endoskopseitig (809509) ..... 806550231

*Zubehör:*

**Aufbereitungskorb**

(L x B x H) 471 x 59 x 54 mm ..... 38021.111

Telescopes 10 mm  
optimized for 4K UHD  
long version

Optiken 10 mm  
optimiert für 4K UHD  
lange Ausführung

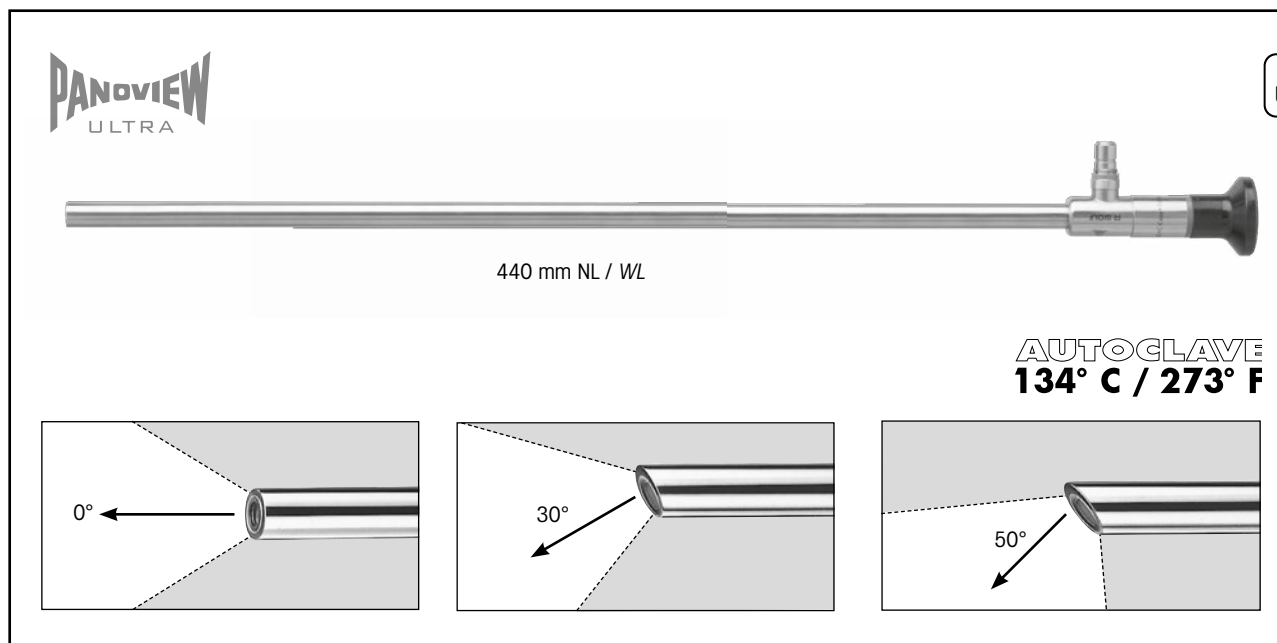

2

**PANOVIEW ULTRA telescope, Ø 10 mm**

0° .....	89344416
30° .....	89344426
50° .....	89344436

**PANOVIEW ULTRA Optik, Ø 10 mm**

0° .....	89344416
30° .....	89344426
50° .....	89344436

*Recommended light cable:*

**Fiber light cable bundle,**

Ø 5.0 mm, 2.3 m long consisting of:

Fiber light cable (80665023),

adapter on the projector side (8095.07) and

adapter on the endoscope side (809509) ..... 806650231

**Fusion fiber light cable bundle,**

Ø 5.0 mm, 2.3 m long consisting of:

Fusion fiber light cable (80655023),

adapter on the projector side (8095.07) and

adapter on the endoscope side (809509) ..... 806550231

*Accessories:*

**Reprocessing basket**

(L x W x H) 610 x 59 x 54 mm ..... 38022.111

*Empfohlene Lichtleiter:*

**Fiber Lichtleiter komplett,**

Ø 5.0 mm, 2,3 m lang bestehend aus:

Fiber Lichtleiter (80665023),

Adapter projektorseitig (8095.07) und

Adapter endoskopseitig (809509) ..... 806650231

**Fusion Fiber Lichtleiter komplett,**

Ø 5.0 mm, 2,3 m lang bestehend aus:

Fusion Fiber Lichtleiter (80655023),

Adapter projektorseitig (8095.07) und

Adapter endoskopseitig (809509) ..... 806550231

*Zubehör:*

**Aufbereitungskorb**

(L x B x H) 610 x 59 x 54 mm .....38022.111

**Endo TORCH**

*Light Tube for the MILOS Technique  
(Mini Less Open Sublay Technique)*

**Endo TORCH**

Lichtrohr zur MILOS-Technik  
(Mini Less Open Sublay-Technik)

2

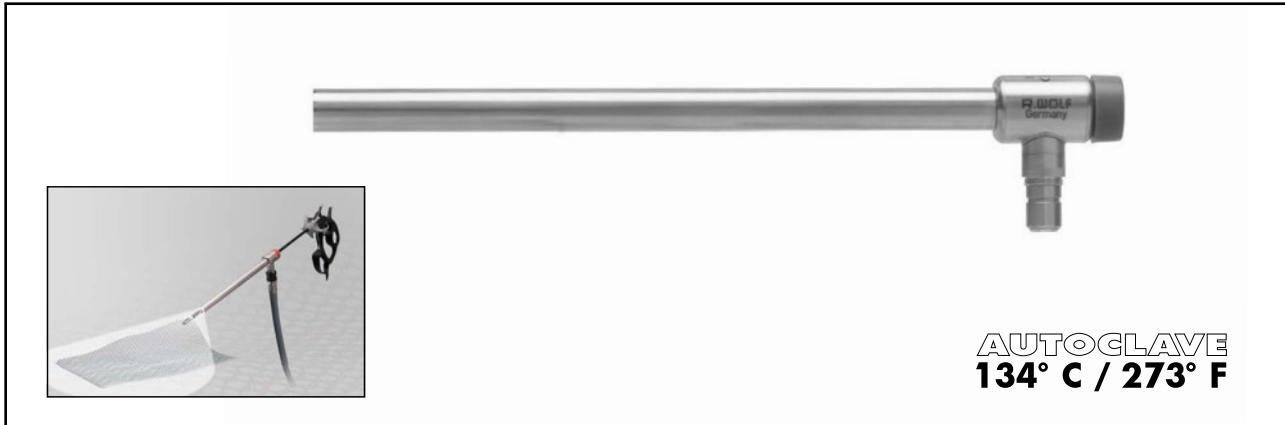

	Instrumentenkanal <i>Instrument channel</i>	Ø	GL / TL	Type / Type
 <b>Lichtrohr zur MILOS-Technik</b> <i>Light tube for the MILOS technique</i>	5 mm	10 mm	200 mm	<b>893420</b>

The **light tube** for the **MILOS technique** (Mini Less Open Sublay technique) has been developed in cooperation with Dr. Reinpold, Head of the Department of Surgery at the Wilhelmsburger Hospital Groß-Sand, Hamburg, Germany, especially for the treatment of abdominal-wall/incisional hernias (open, laparoscopic assisted operation).

The **light tube** offers a 5 mm instrument channel to allow for the introduction of a grasping instrument (e.g. a 5 mm ERAGONmodular instrument) in order to position the appropriate mesh (e.g. DynaMesh CICAT). The light tube is connected to a light source and it completely illuminates the surgical area.

Das **Lichtrohr** zur **MILOS-Technik** (Mini Less Open Sublay-Technik) wurde mit Hr. Dr. Wolfgang Reinpold, Chefarzt am Wilhelmsburger Krankenhaus Groß-Sand, Hamburg speziell für die laparoskopisch-assistierte Behandlung der Bauchwand/Narbenhernie entwickelt.

Das **Lichtrohr** besitzt einen 5 mm Instrumentenkanal in welchen ein entsprechendes Instrument (ERAGONmodular, 5 mm) eingeführt werden kann, um das Netz (z.B. DynaMesh CICAT) zu platzieren.

Das Lichtrohr wird an eine Lichtquelle angeschlossen und leuchtet dann das Operationsgebiet vollständig aus.

**Fusion fiber light cable bundle**, Ø 5.0 mm, 2.3 m long consisting of:  
 Fusion fiber light cable (80655023),  
 adapter on the projector side (8095.07) and  
 adapter on the endoscope side (809509) ..... 806550231  
 (for maximum light transmission)

Empfohlene Lichtleiter:  
**Fiber Lichtleiter komplett**,  
 Ø 5,0 mm, 2,3 m lang bestehend aus:  
 Fiber Lichtleiter (80665023),  
 Adapter projektorseitig (8095.07) und  
 Adapter endoskopseitig (809509) ..... 806650231

## Laparoscopes

### Accessories



## Laparoskope

### Zubehör

**Steriladapter,**

Okulartrichter für Endoskop-Wechsel unter sterilen Bedingungen,  
Spannverschluss ..... 8580.91

**Sterile adapter,**

plug-eyepiece for endoscope exchange under sterile conditions,  
lock mechanism ..... 8580.91

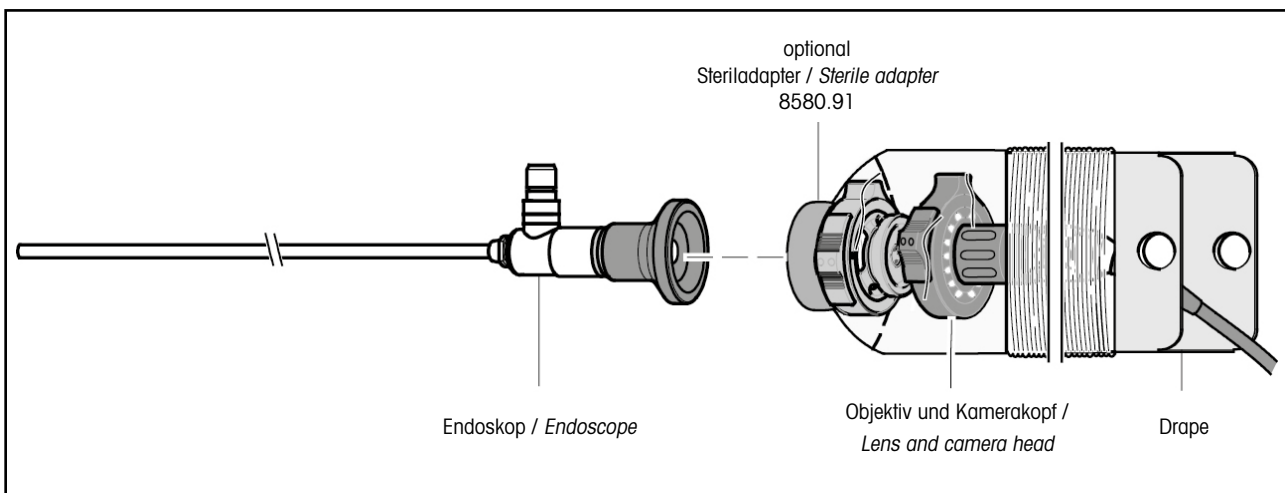

2





Trocar Sleeves 2 mm

Trocarhülsen 2 mm

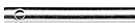
3

Trocarhülse mit Insufflations-Anschluss					<b>Trokar, Spitze dreikantig</b>  
<i>Trocar sleeve with insufflation connector</i>		Durchlass / Capacity	Typen / Types	<i>Trocar, pyramidal tip</i>	
Metallrohr, glatt, distal gerade				<b>8309.121</b>	
					
<i>Metal sleeve, standard, straight distal tip</i>	NL / WL 100 mm	2 mm	<b>8309.014</b>	<b>8309.123</b>	







Trocarhülse					<b>Trokar, Spitze dreikantig</b>  
<i>Trocar sleeve</i>		Durchlass / Capacity	Typen / Types	<i>Trocar, pyramidal tip</i>	
Kunststoffrohr mit Gewinde, distal gerade				<b>8309.121</b>	
					
<i>Plastic sleeve with retaining thread, straight distal tip</i>	NL / WL 60 mm	2 mm	<b>8309.072</b>	<b>8309.121</b>	

Spare sealing caps, PACK=10 PCS ..... 88.01

Ersatz-Dichtungskappen, VE=10 ST ..... 88.01

## Trocar Sleeves 3.5 mm

## Trocarhülsen 3,5 mm

<b>RIWO-ART-Trocarhülsen mit Magnet-Kugel-Ventil mit Insufflationshahn</b>  <i>RIWO-ART trocar sleeves with magnetic-ball-valve with insufflation tap</i>			<b>Trocar, Spitze kegelig-stumpf</b>  <i>Trocar, blunt conical tip</i>	<b>Trocar, Spitze dreikantig</b>  <i>Trocar, pyramidal tip</i>
	Durchlass / Capacity	Typen / Types		
Metallrohr, glatt, distal gerade  <i>Metal sleeve, standard, straight distal tip</i>	NL / WL 100 mm	3.5 mm	<b>8903.014</b>	<b>8903.103</b>  <b>8903.123</b>
Kunststoffrohr mit Gewinde, distal gerade 	NL / WL 60 mm	3.5 mm	<b>8903.072</b>	<b>8903.101</b>  <b>8903.121</b>
Kunststoffrohr mit Gewinde, distal gerade  <i>Plastic sleeve with retaining thread, straight distal tip</i>	NL / WL 100 mm	3.5 mm	<b>8903.034</b>	<b>8903.103</b>  <b>8903.123</b>

Spare ball, 1 piece, capacity Ø 3.5 mm - 5.5 mm ..... 8921.901  
 Spare o-rings, PACK=10 PCS,  
 capacity Ø 3.5 mm - 5.5 mm ..... 8921.951  
 Spare sealing caps, PACK=10 PCS,  
 capacity 3.5 mm, red ..... 89.01  
 Spare plug, PACK=5 PCS ..... 896.0002







Ersatzkugel, 1 Stück, Durchlass Ø 3,5 mm - 5,5 mm ..... 8921.901  
 Ersatz-O-Ringe, VE=10 ST,  
 Durchlass Ø 3,5 mm - 5,5 mm ..... 8921.951  
 Ersatz-Dichtungskappen, VE=10 ST,  
 Durchlass 3,5 mm, rot ..... 89.01  
 Ersatz-Hahnküken, VE=5 ST ..... 896.0002

<b>Kunststoff-Trocarhülse</b>  <i>Plastic trocar sleeve</i>			<b>Trocar, kugelig</b>  <i>Trocar, ball shaped</i>
	Durchlass / Capacity	Type / Type	
Schaft mit distalem Schraubanker  <i>Distal straight with anchor</i>	NL / WL 40 mm	3.5 mm	<b>8929.223</b>  <b>8929.2215</b>

## Trocar Sleeves 5.5 mm

## Trokarhülsen 5,5 mm

3

RIWO-ART-Trokarhülsen mit Magnet-Kugel-Ventil mit Insufflationshahn 		Durchlass / Capacity	Typen / Types	Trocar, Spitze kegelig-stumpf	Trocar, Spitze kegelig-spitz	Trocar, Spitze dreikantig
RIWO-ART trocar sleeves with magnetic-ball-valve with insufflation tap				Trocar, blunt conical tip	Trocar, conical tip	Trocar, pyramidal tip
Metallrohr, glatt, distal gerade 	NL / WL 100 mm	5.5 mm	<b>8921.014</b>	<b>8921.103</b>	<b>8921.113</b>	<b>8921.123</b>
<i>Metal sleeve, standard, straight distal tip</i>	NL / WL 150 mm	5.5 mm	<b>8921.016</b>	<b>8921.105</b>	<b>8921.115</b>	<b>8921.125</b>
Metallrohr, glatt, distal abgeschrägt 	NL / WL 100 mm	5.5 mm	<b>8921.013</b>	<b>8921.103</b>	<b>8921.113</b>	<b>8921.123</b>
<i>Metal sleeve, standard, oblique distal tip</i>	NL / WL 100 mm	5.5 mm	<b>8921.024</b>	<b>8921.103</b>	<b>8921.113</b>	<b>8921.123</b>
Metallrohr mit Gewinde, distal gerade 	NL / WL 100 mm	5.5 mm	<b>8921.024</b>	<b>8921.103</b>	<b>8921.113</b>	<b>8921.123</b>
<i>Metal with retaining thread, straight distal tip</i>	NL / WL 150 mm	5.5 mm	<b>8921.026</b>	<b>8921.105</b>	<b>8921.115</b>	<b>8921.125</b>
Metallrohr mit Gewinde, distal abgeschrägt 	NL / WL 100 mm	5.5 mm	<b>8921.023</b>	<b>8921.103</b>	<b>8921.113</b>	<b>8921.123</b>
<i>Metal sleeve with retaining thread, oblique distal tip</i>	NL / WL 100 mm	5.5 mm	<b>8921.034</b>	<b>8921.103</b>	<b>8921.113</b>	<b>8921.123</b>
Kunststoffrohr mit Gewinde, distal gerade 	NL / WL 100 mm	5.5 mm	<b>8921.034</b>	<b>8921.103</b>	<b>8921.113</b>	<b>8921.123</b>
<i>Plastic sleeve with retaining thread, straight distal tip</i>						









Spare ball, 1 piece, capacity Ø 3.5 mm - 5.5 mm ..... 8921.901  
 Spare o-rings, PACK=10 PCS, capacity Ø 3.5 mm - 5.5 mm. 8921.951  
 Spare sealing caps, PACK=10 PCS,  
 capacity 5.5 mm, blue ..... 89.02  
 Spare plug ..... 896.0002

Ersatzkugel, 1 Stück, Durchlass Ø 3,5 mm - 5,5 mm..... 8921.901  
 Ersatz-O-Ringe, VE=10 ST, Durchlass Ø 3,5 mm - 5,5 mm .. 8921.951  
 Ersatz-Dichtungskappen, VE=10 ST,  
 Durchlass 5,5 mm, blau..... 89.02  
 Ersatz-Hahnküken ..... 896.0002



Trocar Sleeves 5.5 mm

Trokarhülsen 5,5 mm

RIWO-ART-Trokarhülsen mit Magnet-Kugel-Ventil				Trokar, Spitze kegelig-stumpf	Trokar, Spitze kegelig-spitz	Trokar, Spitze dreikantig
						
<i>RIWO-ART trocar sleeves with magnetic-ball-valve</i>		Durchlass / Capacity	Typen / Types	<i>Trocar, blunt conical tip</i>	<i>Trocar, conical tip</i>	<i>Trocar, pyramidal tip</i>
Metallrohr, glatt, distal gerade	NL / WL 60 mm	5.5 mm	<b>8921.052</b>	<b>8921.101</b>	<b>8921.111</b>	<b>8921.121</b>
	NL / WL 100 mm	5.5 mm	<b>8921.054</b>	<b>8921.103</b>	<b>8921.113</b>	<b>8921.123</b>
Metallrohr, glatt, distal abgeschrägt	NL / WL 60 mm	5.5 mm	<b>8921.051</b>	<b>8921.101</b>	<b>8921.111</b>	<b>8921.121</b>
	NL / WL 100 mm	5.5 mm	<b>8921.053</b>	<b>8921.103</b>	<b>8921.113</b>	<b>8921.123</b>
Metallrohr mit Gewinde, distal gerade	NL / WL 60 mm	5.5 mm	<b>8921.062</b>	<b>8921.101</b>	<b>8921.111</b>	<b>8921.121</b>
	NL / WL 60 mm	5.5 mm	<b>8921.061</b>	<b>8921.101</b>	<b>8921.111</b>	<b>8921.121</b>
Metallrohr mit Gewinde, distal abgeschrägt	NL / WL 60 mm	5.5 mm	<b>8921.061</b>	<b>8921.101</b>	<b>8921.111</b>	<b>8921.121</b>
	NL / WL 60 mm	5.5 mm	<b>8921.072</b>	<b>8921.101</b>	<b>8921.111</b>	<b>8921.121</b>
Kunststoffrohr mit Gewinde, distal gerade	NL / WL 60 mm	5.5 mm	<b>8921.072</b>	<b>8921.101</b>	<b>8921.111</b>	<b>8921.121</b>
						

Spare ball, 1 piece, capacity Ø 3.5 mm - 5.5 mm.....8921.901  
 Spare o-rings, PACK=10 PCS, capacity Ø 3.5 mm - 5.5 mm.8921.951  
 Spare sealing caps, PACK=10 PCS,  
 capacity 5.5 mm, blue ..... 89.02

Ersatzkugel, 1 Stück, Durchlass Ø 3,5 mm - 5,5 mm..... 8921.901  
 Ersatz-O-Ringe, VE=10 ST, Durchlass Ø 3,5 mm - 5,5 mm..8921.951  
 Ersatz-Dichtungskappen, VE=10 ST,  
 Durchlass 5,5 mm, blau..... 89.02

**TROTEC Protective Trocars**  
for 5.5 mm trocar sleeves

**TROTEC Schutztrokare**  
für Trokarhülsen 5,5 mm

3

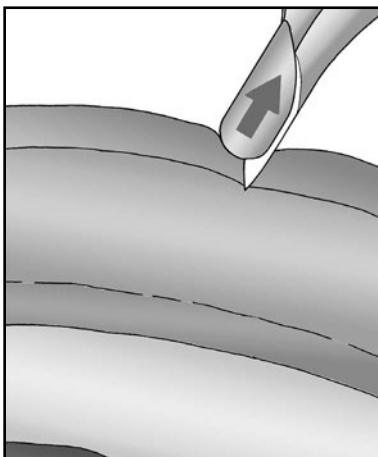
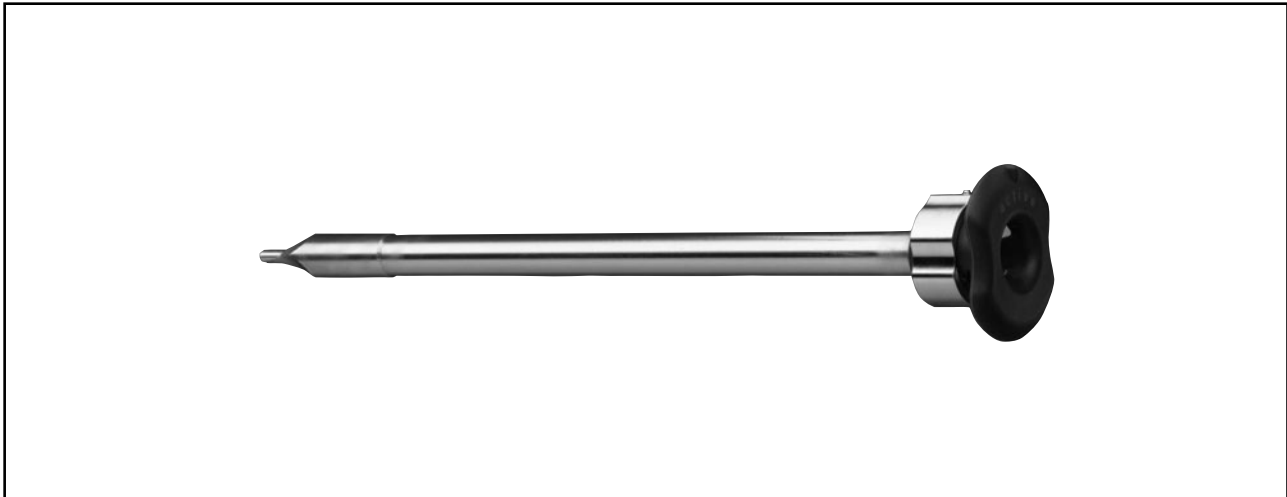

Schutzdorn schiebt sich automatisch durch Kontakt mit der Bauchdecke in die Kanüle zurück.

*The protective rod retracts automatically into the cannula when it makes contact with the abdominal wall.*

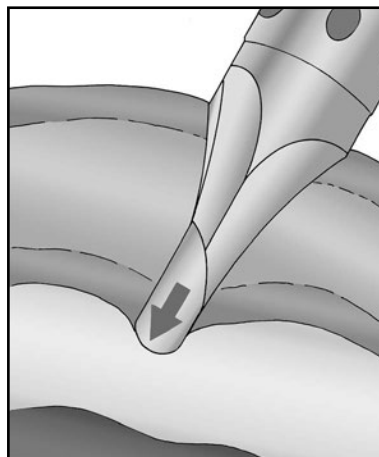

Unmittelbar nach Durchdringen des Peritoneums schnell der Schutzdorn in das freie Abdomen.

*Immediately after penetrating the peritoneum, the protective rod snaps back into the free abdominal cavity.*

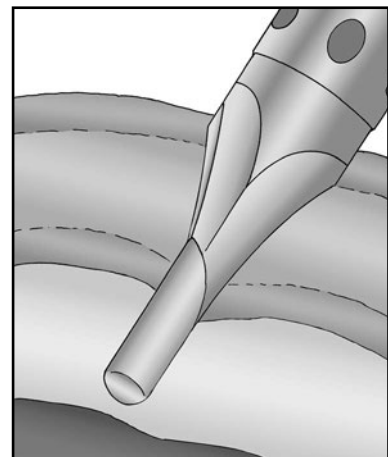





Der weit nach distal positionierte atraumatische Schutzdorn verhindert die Perforation von Organen und Gefäßen.

*The extreme distal position of the atraumatic protective rod prevents perforation of organs and vessels.*

TROTEC-Trokar bestehend aus: TROTEC trocar consisting of:			TROTEC-Trokar komplett TROTEC trocar complete	Für RIWO ART-Trokarhülse mit: For RIWO ART trocar sleeves: (BDE 34+35)	
Schaft mit Kanülen- spitze, kegelig / Sheath with conical cannula tip	Schaft mit Lanzetten- spitze, zweikantig / Sheath with two- edged lancet tip	Griff mit federndem Schutzstab / Handle with spring- mounted protective rod		NL mm WL mm	Ø mm
8921.132		8923.135	<b>8921.131</b>	100 mm	5.5 mm
	8921.134	8923.135	<b>8921.133</b>	100 mm	5.5 mm

*Flexible Trocar Sleeves 5.5 mm  
for curved instruments*

*Flexible Trokarhülsen 5,5 mm  
für gebogene Instrumente*

 <p><b>AUTOCLAVE</b> <b>134° C / 273° F</b></p>				<p><b>Trokar,</b> kegelig stumpf</p> 	<p><b>Trokar,</b> kegelig spitz</p> 	<p><b>Trokar,</b> dreikantig</p> 	<p><b>Trokar,</b> kugelig</p> 
	NL / WL	Durchlass / Capacity	Typen / Types	<i>Trocar,</i> blunt conical tip	<i>Trocar,</i> conical tip	<i>Trocar,</i> pyramidal tip	<i>Trocar,</i> ball shaped
<p><b>Kunststoffschaft mit Gewinde, distal gerade, inkl. Membranventil 89.103 (VE=10 ST)</b></p>	62 mm	5.8 mm	<b>8905.331</b>	<b>8905.3311</b>	<b>8905.3312</b>	<b>8905.3313</b>	<b>8905.3315</b>
	102 mm	5.8 mm	<b>8905.351</b>	<b>8905.3511</b>	<b>8905.3512</b>	<b>8905.3513</b>	<b>8905.3515</b>
	178 mm	5.8 mm	<b>8905371</b>	<b>89053711</b>	-	-	-
<p><b>Plastic sheath with retaining thread, straight distal tip, incl. membrane valves 89.103 (PACK=10 PCS)</b></p>							

3

**Membrane valves, yellow, PACK=10 PCS.....89.103**

**Membran-Ventil, gelb, VE=10 ST .....89.103**

### Trocar Sleeves 5.5 mm

plastic with membrane seal

### Trocarhülsen 5,5 mm

Kunststoff mit Dichtmembrane



**AUTOCLAVE**  
**134° C / 273° F**

Trocar,  
kegelig stumpf

Trocar,  
kegelig spitz

Trocar,  
Spitze dreikantig



*Trocar,*  
*blunt conical tip*

*Trocar,*  
*conical tip*

*Trocar,*  
*pyramidal tip*

	NL / WL	Durchlass / Capacity	mit Hahn / with cock	Typen / Types	<i>Trocar,</i> <i>blunt conical tip</i>	<i>Trocar,</i> <i>conical tip</i>	<i>Trocar,</i> <i>pyramidal tip</i>
<b>Selbsthaltende Kunststofftrocarhülse,</b> autoklavierbar, inkl. Membranventil 89.103 (VE=10 ST) <b>Self retaining plastic trocar sleeve,</b> autoclavable, incl. membrane valve 89.103 (PACK=10 PCS)	65 mm	5.5 mm	■	<b>8919.333</b>	<b>8919.3311</b>	<b>8919.3312</b>	<b>8919.3313</b>
		5.5 mm		<b>8919.331</b>			
	105 mm	5.5 mm	■	<b>8919.353</b>	<b>8919.3511</b>	<b>8919.3512</b>	<b>8919.3513</b>
		5.5 mm		<b>8919.351</b>			

Membrane valves, yellow, PACK=10 PCS..... 89.103



Spare plug, PACK= 5 ..... 896.0002

Membran-Ventil, gelb, VE=10 ST ..... 89.103

Ersatz-Hahnküken, VE=5 ST ..... 896.0002





## Trocar Sleeves 5.5 mm

## Trokarhülsen 5,5 mm

<p><b>Flexible Trokarhülse, Kunststoff</b></p> 				<p><b>Trokar,</b> Spitze stumpf, kegelig</p> 
<p><i>Flexible trocar sleeve, plastic</i></p>	NL / WL	Durchlass / Capacity	Type / Type	<p><b>Trocar,</b> blunt, conical tip</p>
<p>distal abgechrägt</p>  <p><i>oblique distal tip</i></p>	75 mm	5.5 mm	<b>8906.051</b>	<b>8906.151</b>

**Trocar Sleeves 10 mm**  
with insufflation tap

**Trocarhülsen 10 mm**  
mit Insufflationshahn





RIWO-ART-Trocarhülsen mit Magnet-Kugel-Ventil				Trocar, Spitze kegelig-stumpf	Trocar, Spitze kegelig-spitz	Trocar, Spitze dreikantig	
<i>RIWO-ART trocar sleeves with magnetic-ball-valve</i>		Durchlass / Capacity	Typen / Types	<i>Trocar, blunt conical tip</i>	<i>Trocar, conical tip</i>	<i>Trocar, pyramidal tip</i>	
Metallrohr, glatt, distal gerade		NL / WL 100 mm	10 mm	<b>8923.014</b>	<b>8923.103</b>	<b>8923.113</b>	<b>8923.123</b>
<i>Metal sleeve, standard, straight distal tip</i>		NL / WL 150 mm	10 mm	<b>8923.016</b>	-	<b>8923.115</b>	<b>8923.125</b>
Metallrohr, glatt, distal abgeschrägt		NL / WL 100 mm	10 mm	<b>8923.013</b>	<b>8923.103</b>	<b>8923.113</b>	<b>8923.123</b>
<i>Metal sleeve, standard, oblique distal tip</i>							
Metallrohr mit Gewinde, distal gerade		NL / WL 100 mm	10 mm	<b>8923.024</b>	<b>8923.103</b>	<b>8923.113</b>	<b>8923.123</b>
<i>Metal with retaining thread, straight distal tip</i>		NL / WL 150 mm	10 mm	<b>8923.026</b>	-	<b>8923.115</b>	<b>8923.125</b>
Metallrohr mit Gewinde, distal abgeschrägt		NL / WL 100 mm	10 mm	<b>8923.023</b>	<b>8923.103</b>	<b>8923.113</b>	<b>8923.123</b>
<i>Metal sleeve with retaining thread, oblique distal tip</i>							

Spare ball, 1 piece, capacity Ø 7 mm - 12.5 mm ..... 8923.901  
 Spare o-rings, PACK=10, capacity Ø 7 mm - 12.5 mm ..... 8923.951  
 Spare sealing caps, PACK=10 PCS, capacity 10 mm, red ..... 89.08  
 Spare plug, PACK=5 PCS ..... 896.0002

Ersatzkugel, 1 Stück, Durchlass Ø 7 mm - 12,5 mm ..... 8923.901  
 Ersatz-O-Ringe, VE=10 ST, Durchlass Ø 7 mm - 12,5 mm ... 8923.951  
 Ersatz-Dichtungskappen, VE=10 ST, Durchlass 10 mm, rot ..... 89.08  
 Ersatz-Hahnküken, VE=5 ST ..... 896.0002

**TROTEC protective trocars**

**TROTEC Schutztrokare**



TROTEC-Trocar bestehend aus: TROTEC trocar consisting of:				Für RIWO ART-Trocarhülse mit: For RIWO ART trocar sleeves:	
			TROTEC-Trocar komplett TROTEC trocar complete		
Schaft mit Kanülen- spitze, kegelig / Sheath with conical cannula tip	Schaft mit Lanzetten- spitze, zweikantig / Sheath with two- edged lance tip	Griff mit federndem Schutzstab / Handle with spring- mounted protective rod		NL WL	Ø
8923.132		8923.135	<b>8923.131</b>	100 mm	10 mm
	8923.134	8923.135	<b>8923.133</b>	100 mm	10 mm

## High-Flow Trocar Sleeves

with high flow hose connection  
10 mm

## High-Flow-Trokarhülsen

mit High-Flow-Insufflationsschlauch-Anschluss  
10 mm

RIWO-ART-Trokarhülsen mit Magnet-Kugel-Ventil,				Trokar, Spitze kegelig-stumpf	Trokar, Spitze kegelig-spitz	Trokar, Spitze dreikantig
<i>RIWO-ART trocar sleeves with magnetic-ball-valve</i>		Durchlass / Capacity	Typen / Types	<i>Trocar, blunt conical tip</i>	<i>Trocar, conical tip</i>	<i>Trocar, pyramidal tip</i>
 Metallrohr, glatt, distal gerade  Metal sleeve, standard, straight distal tip	NL / WL 100 mm	10 mm	<b>8923.042</b>	<b>8923.103</b>	<b>8923.113</b>	<b>8923.123</b>

*VARIO-PORT reducing adapter, PACK=5 PCS*  
 for reduction from  
 Ø 10 mm to Ø 5.5 mm and  
 Ø 12.5 mm to Ø 5.5 mm ..... 8923.802



**VARIO-PORT-Reduzieradapter, VE=5 ST**  
 zur Reduktion von  
 Ø 10 mm auf Ø 5,5 mm und  
 Ø 12,5 mm auf Ø 5,5 mm ..... 8923.802



*Spare ball, 1 piece, capacity Ø 7 mm - 12.5 mm ..... 8923.901*  
*Spare o-rings, PACK=10 PCS, capacity Ø 7 mm - 12.5 mm .8923.951*  
*Spare sealing caps, PACK=10 PCS,*  
*capacity 10 mm, red..... 89.08*

**Ersatzkugel, 1 Stück, Durchlass Ø 7 mm - 12,5 mm ..... 8923.901**  
**Ersatz-O-Ringe, VE=10 ST, Ø 7 mm - 12,5 mm ..... 8923.951**  
**Ersatz-Dichtungskappen, VE=10 ST,**  
**Durchlass 10 mm,rot ..... 89.08**

## Trocar Sleeves 10 mm

## Trokarhülsen 10 mm





3

Flexible Trokarhülse, Kunststoff				Trokar, Spitze stumpf, kegelig
<i>Flexible trocar sleeve, plastic</i>	NL / WL	Durchlass / Capacity	Type / Type	<i>Trocar, blunt, conical tip</i>
 distal gerade   straight distal tip	60 mm	10 mm	<b>8906.011</b>	<b>8906.111</b>



**Trocar Sleeves 12.5 mm**  
with insufflation tap



**Trocarhülsen 12,5 mm**  
mit Insufflationshahn

RIWO-ART-Trocarhülsen mit Magnet-Kugel-Ventil				Trocar, Spitze kegelig-stumpf	Trocar, Spitze kegelig-spitz	Trocar, Spitze dreikantig
<i>RIWO-ART trocar sleeves with magnetic-ball-valve</i>				<i>Trocar, blunt conical tip</i>	<i>Trocar, conical tip</i>	<i>Trocar, pyramidal tip</i>
	Durchlass / Capacity	Typen / Types				
 Metallrohr, glatt, distal gerade Metal sleeve, standard, straight distal tip	NL / WL 100 mm	12.5 mm	<b>8924.014</b>	<b>8924.103</b>	<b>8924.113</b>	<b>8924.123</b>
 Metal sleeve, standard, straight distal tip	NL / WL 150 mm	12.5 mm	<b>8924.016</b>	-	<b>8924.115</b>	<b>8924.125</b>
 Metallrohr, glatt, distal abgeschrägt Metal sleeve, standard, oblique distal tip	NL / WL 100 mm	12.5 mm	<b>8924.013</b>	<b>8924.103</b>	<b>8924.113</b>	<b>8924.123</b>
 Metallrohr mit Gewinde, distal gerade Metal with retaining thread, straight distal tip	NL / WL 150 mm	12.5 mm	<b>8924.026</b>	-	<b>8924.115</b>	<b>8924.125</b>

**VARIO-PORT reducing adapter, PACK=5 PCS**  
for reduction from  
 Ø 10 mm to Ø 5.5 mm and  
 Ø 12.5 mm to Ø 5.5 mm ..... 8923.802  
 Ø 12.5 mm to Ø 10 mm ..... 8924.802





**VARIO-PORT-Reduzieradapter, VE=5 ST**  
zur Reduktion von  
 Ø 10 mm auf Ø 5,5 mm und  
 Ø 12,5 mm auf Ø 5,5 mm..... 8923.802  
 Ø 12,5 mm auf Ø 10 mm..... 8924.802

TROTEC-Trocar bestehend aus: <i>TROTEC trocar consisting of:</i>			Für RIWO ART-Trocarhülse mit: <i>For RIWO ART trocar sleeves:</i>	
 Schaft mit Lanzettenspitze, zweikantig / Sheath with two-edged lancet tip	 Griff mit federndem Schutzstab / Handle with spring-mounted protective rod	TROTEC-Trocar komplett <i>TROTEC trocar complete</i>	 NL WL	Ø
8924.134	8923.135	<b>8924.133</b>	100 mm	12.5 mm

Trocar Sleeve 12.5 mm

Trokarhülse 12,5 mm

<p><b>Flexible Trokarhülse, Kunststoff</b></p> 				<p><b>Trokar,</b> Spitze stumpf, kegelig</p> 
<p><i>Flexible trocar sleeve, plastic</i></p>	NL / WL	Durchlass / Capacity	Type / Type	<p><b>Trocar,</b> blunt, conical tip</p>
<p>distal gerade</p>  <p><i>straight distal tip</i></p>	60 mm	12.5 mm	<b>8906.031</b>	<b>8906.131</b>

3

*Dilatation  
and Extraction Instruments*  
5.5 to 10 / 10 to 12.5 mm

Dilatations-  
und Extraktions-Instrumente  
5,5 bis 10 / 10 bis 12,5 mm

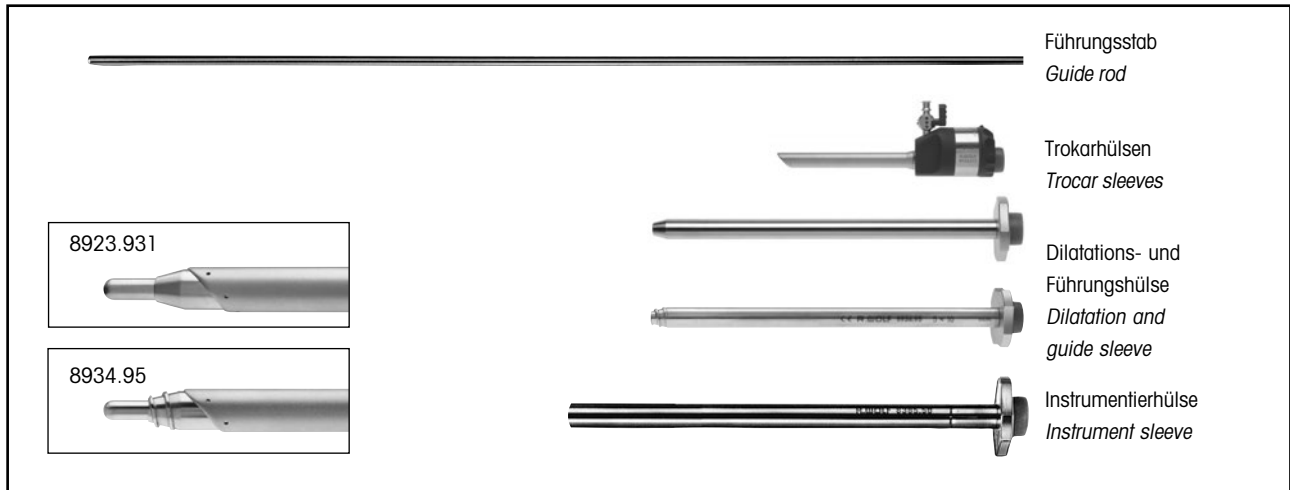

Zur Erweiterung einer Inzision <i>To extend an incision</i>	Führungsstab <i>Guide rod</i>	Trokarhülse <i>Trocar sleeve</i>	Dilatations- und Führungshülse <i>Dilatation and guide sleeve</i>	Instrumentierhülse, Extraktor und Reduzierhülse <i>Instrument sleeve, extractor and reducing sleeve</i>
3.5 mm bis / to 5.5 mm	-	<b>8921.013</b>	-	<b>8383.78*</b>
5.5 mm bis / to 10 mm <i>(5.0 mm bis / to 10 mm)</i>	<b>8923.921</b> <b>(8934.951)</b>	<b>8923.013</b>	<b>8923.931</b> <b>(8934.95)</b>	<b>8385.50**</b>
10 mm bis / to 12.5 mm <i>5 mm bis / to 12.5 mm</i>	<b>8943.901</b>	<b>8924.013</b>	-	<b>8941.901***</b> <b>8941.951****</b>

for sealed application of

\* 3,5 mm instruments in the 5.5 mm trocar sleeve

\*\* 5 mm instruments in the 12.5 mm trocar sleeve

\*\*\* 10 mm instruments in the 12.5 mm trocar sleeve

\*\*\*\*5 mm instruments in the 12.5 mm trocar sleeve

and for extraction of the appendix.

zur abgedichteten Anwendung von

\* 3,5-mm-Instrumenten in der 5,5-mm-Trokarhülse .

\*\* 5-mm-Instrumenten in der 12,5-mm-Trokarhülse

\*\*\* 10-mm-Instrumenten in der 12,5-mm-Trokarhülse

\*\*\*\* 5-mm-Instrumenten in der 12,5-mm-Trokarhülse

sowie zur Appendixextraktion.

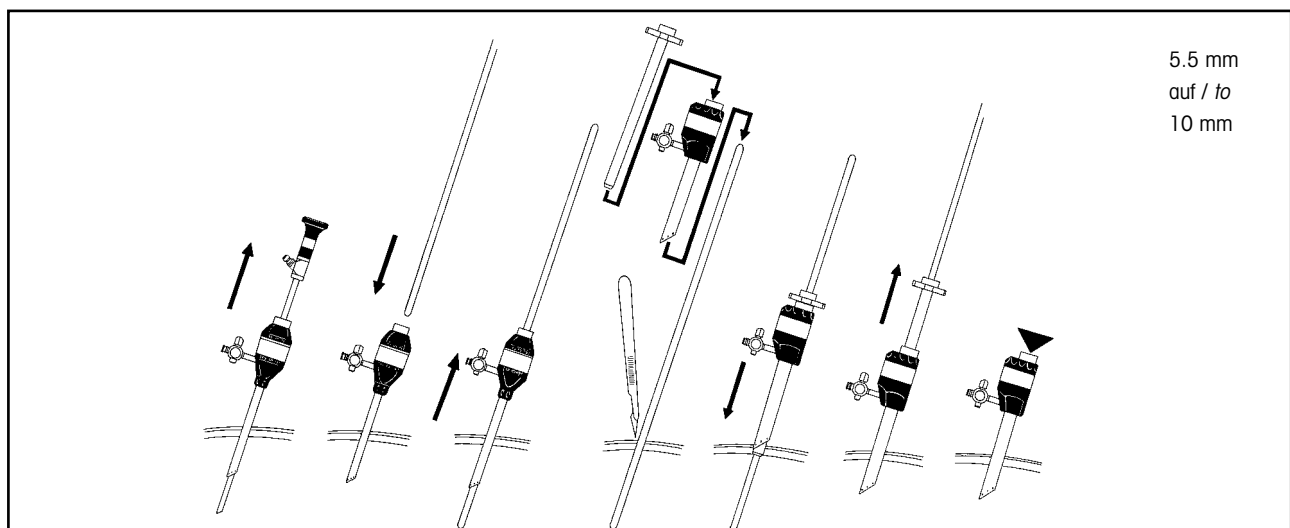

## Reducing Sleeves

for RIWO-ART trocar sleeves

## Reduzierhülsen

für RIWO-ART-Trokarhülsen

3

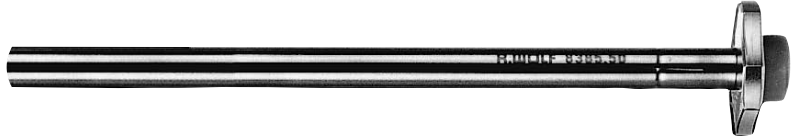

	Außen-Ø Outer Ø	NL / WL	für Instrumente for instrument sizes	Typen / Types
5.5 / 3.5 mm Reduzierhülse* Reducing sleeve*	5.5 mm	160 mm	3.5 mm	<b>8383.78</b>
10.0 / 5.5 mm Instrumentierhülse und Extraktor* Instrument sleeve and extractor*	10 mm	170 mm	5.5 mm	<b>8385.50</b>
12.5 / 10.0 mm Reduzierhülse** Reducing sleeve**	12.5 mm	180 mm	10 mm	<b>8941.901</b>
12.5 / 5.5 mm Reduzierhülse* Reducing sleeve*	12.5 mm	180 mm	5.5 mm	<b>8941.951</b>

\* Spare sealing caps, PACK=10 PCS ..... 89.02  
 \*\* Spare sealing caps, PACK=10 PCS ..... 89.08

\* Ersatz-Dichtungskappen, VE=10 ST ..... 89.02  
 \*\* Ersatz-Dichtungskappen, VE=10 ST ..... 89.08



	Reduktion von Reduction from	auf / to	Typen / Types
VARIO-PORT-Reduzier- adapter, 5 ST  VARIO-PORT reducing adapter, PACK=5 PCS	Ø 7 mm Ø 10 mm Ø 12.5 mm	Ø 5.5 mm	<b>8923.802</b>
	Ø 12.5 mm	Ø 10 mm	<b>8924.802</b>

## Endodilator

## Endo-Spreizer

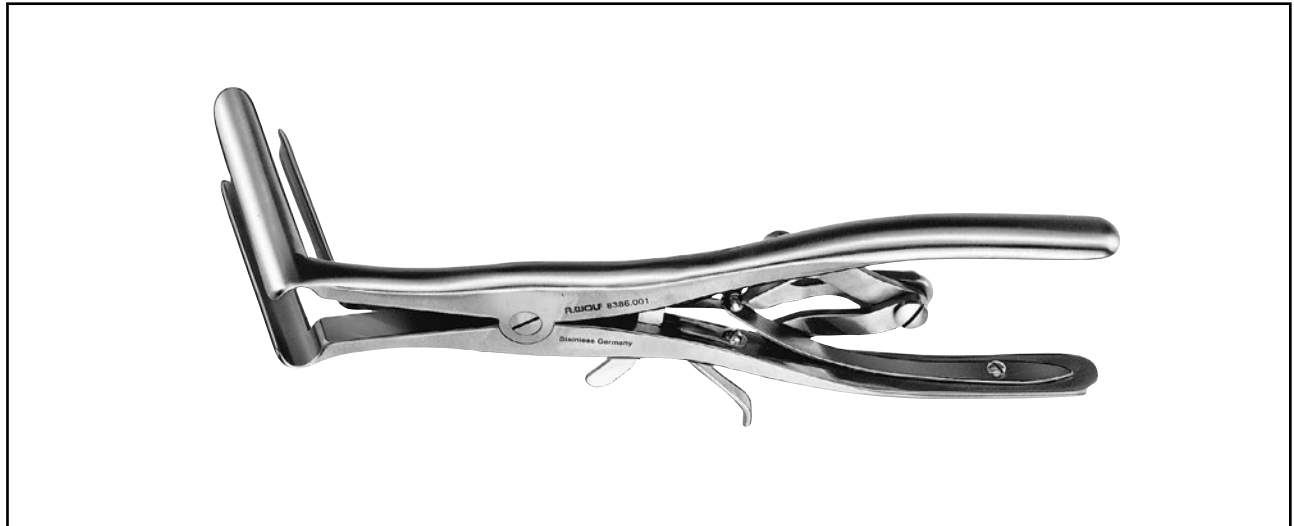

3

To extend the incision and for problem-free extraction of organs in laparoscopic surgery - e.g. removal of a particularly large gallbladder.

Zur Einstich-Erweiterung und problemlosen Organ-Bergung bei der laparoskopischen Chirurgie - z.B. Entfernung einer besonders großen Gallenblase.

- three branches for simple and uniform extension of the incision
- mechanism to lock branches in place

- drei Branchen zur einfachen und gleichmäßigen Inzisions-Erweiterung
- Sperre zur Branchenfixierung

**Endodilator,**

**Ø 14 mm,**

3 branches, handle with locking mechanism,

55 mm WL ..... 8386.001

**Endo-Spreizer,**





**Ø 14 mm,**





3 Branchen, Handgriff mit Sperre,

55 mm NL ..... 8386.001

**ERAGON** modular *micro*  
modular instruments 2 mm

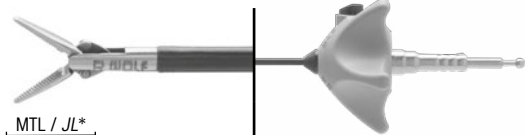
**ERAGON** modular *micro*  
modulare Instrumente 2 mm

<p><b>ERAGON</b> <i>axial</i></p> <p>Alle Innenteile und Schaffrohre sind ebenfalls mit <b>ERAGONaxial</b> kombinierbar. <i>All jaw inserts and sheaths can also be combined with ERAGONaxial.</i></p>	Griffvarianten / Handle type				<p>Drehradaufsatz, <b>ERAGONaxial Knob attachment, ERAGONaxial</b></p>  <p>autoklavierbar / autoclavable</p>
	 <p>mit Sperre, drehbar with locking mechanism, rotatable</p>	 <p>HF / mono ohne Sperre, drehbar without locking mechanism, rotatable</p>	 <p>HF / mono mit Sperre, drehbar with locking mechanism, rotatable</p>	 <p>mit Sperre, nicht drehbar with locking mechanism, not rotatable</p>	

<p>Innenteil mit isoliertem Schaffrohr <i>Jaw insert with insulated sheath tube</i></p>  <p>MTL / JL*</p> <p>NL / WL 240 mm</p>	Griffvarianten / Handle type		<p><b>Komplett-Instrument</b></p> <ul style="list-style-type: none"> <li>• Innenteil mit Schaffrohr</li> <li>• Handgriff</li> </ul> <p><b>Complete instrument</b></p> <ul style="list-style-type: none"> <li>• Jaw insert with sheath tube</li> <li>• Handle</li> </ul>	
	<p>HF / mono</p>  <p>mit Sperre, drehbar with locking mechanism, rotatable</p>	<p>Typen / Types</p> <p>83930074</p>		<p>Typen / Types</p>
 <p><b>Dissektor, gerade, doppelbeweglich</b> MTL= 7 mm <b>Dissector, straight, double jaw action,</b> JL= 7 mm</p>	<p>8388201</p>	<p>•</p>	<p>•</p>	<p><b>83882017</b></p>
 <p><b>Atraumatische Greifzange, gefensternt, doppelbeweglich</b> MTL= 7 mm <b>Atraumatic grasping forceps, fenestrated, double jaw action</b> JL= 7 mm</p>	<p>8388202</p>	<p>•</p>	<p>•</p>	<p><b>83882027</b></p>
 <p><b>Universal-Fasszange, doppelbeweglich</b> MTL= 7 mm <b>Universal grasping forceps, double jaw action</b> JL= 7 mm</p>	<p>8388203</p>	<p>•</p>	<p>•</p>	<p><b>83882037</b></p>

\* JL = Jaw length when jaws closed (approximate measurements)





\* MTL = Maulteillänge bei geschlossenem Maulteil (gerundete Angaben)





also: Irrigation adapter see overleaf.  
HF connecting cable see page BDE 163.

hierzu: Spüladapter siehe Rückseite.  
HF-Anschlusskabel siehe Blatt BDE 163.

**ERAGON modular mini**  
modular instruments 3.5 mm

**ERAGON modular mini**  
modulare Instrumente 3,5 mm

<p><b>ERAGON axial</b></p> <p>Alle Innenteile und Schaftröhre sind ebenfalls mit <b>ERAGONaxial</b> kombinierbar. <i>All jaw inserts and sheaths can also be combined with ERAGONaxial.</i></p>	Griffvarianten / Handle type				<p>Drehradaufsatz, <b>ERAGONaxial Knob attachment, ERAGONaxial</b></p>  <p>autoklavierbar / autoclavable</p>
	 <p>mit Sperre, drehbar with locking mechanism, rotatable</p>	 <p>HF / mono ohne Sperre, drehbar without locking mechanism, rotatable</p>	 <p>HF / mono mit Sperre, drehbar with locking mechanism, rotatable</p>	 <p>mit Sperre, nicht drehbar with locking mechanism, not rotatable</p>	
Typen / Types	83930082	83930083	83930084	83930085	

<p>Innenteil Jaw insert</p>  <p>MTL / JL*</p>	Schaftröhre, isoliert Sheath tube, insulated		Griffvarianten / Handle type		<p><b>Komplett-Instrument</b></p> <ul style="list-style-type: none"> <li>• Innenteil</li> <li>• Schaftröhre</li> <li>• Handgriff</li> </ul> <p><b>Complete instrument</b></p> <ul style="list-style-type: none"> <li>• Jaw insert</li> <li>• Sheath</li> <li>• Handle</li> </ul>	
		NL / WL 240 mm	NL / WL 330 mm	HF / mono		mit Sperre, drehbar with locking mechanism, rotatable
	Typen / Types	8390933	8391933	83930074		
 <p><b>Greif- und Dissektionszange,</b> lang, feine Spitze, doppelbeweglich, MTL= 18 mm <i>Grasping and dissecting forceps, long, fine tip, double jaw action JL= 18 mm</i></p>	8390221	●		●	<b>83902217</b>	
	8391221		●	●	<b>83912217</b>	
 <p><b>Greif- und Dissektionszange,</b> kurz, feine Spitze, doppelbeweglich, MTL= 14 mm <i>Grasping and dissecting forceps, short, fine tip, double jaw action JL= 14 mm</i></p>	8390222	●		●	<b>83902227</b>	
	8391222		●	●	<b>83912227</b>	
 <p><b>Greif- und Dissektionszange,</b> rechts abgewinkelt, doppelbeweglich, MTL= 14 mm <i>Grasping and dissecting forceps, curved right, double jaw action JL= 14 mm</i></p>	8390223	●		●	<b>83902237</b>	
	8391223		●	●	<b>83912237</b>	

\* JL = Jaw length when jaws closed (approximate measurements)





\* MTL = Maulteillänge bei geschlossenem Maulteil (gerundete Angaben)







HF connecting cable see page BDE 163.

HF-Anschlusskabel siehe Blatt BDE 163.

**ERAGON modular mini**  
modular instruments 3.5 mm

**ERAGON modular mini**  
modulare Instrumente 3,5 mm

<p><b>ERAGON axial</b></p> <p>Alle Innenteile und Schaffrohre sind ebenfalls mit <b>ERAGONaxial</b> kombinierbar. <i>All jaw inserts and sheaths can also be combined with ERAGONaxial.</i></p>	Griffvarianten / Handle type				<p>Drehradaufsatz, ERAGONaxial Knob attachment, ERAGONaxial</p>  <p>autoklavierbar / autoclavable</p>
	 <p>mit Sperre, drehbar with locking mechanism, rotatable</p>	 <p>HF / mono ohne Sperre, drehbar without locking mechanism, rotatable</p>	 <p>HF / mono mit Sperre, drehbar with locking mechanism, rotatable</p>	 <p>mit Sperre, nicht drehbar with locking mechanism, not rotatable</p>	
Typen / Types	83930082	83930083	83930084	83930085	8988

<p>Innenteil Jaw insert</p>  <p>MTL / JL*</p>	Schaffrohr, isoliert Sheath tube, insulated		Griffvarianten / Handle type		<p><b>Komplett-Instrument</b></p> <ul style="list-style-type: none"> <li>• Innenteil</li> <li>• Schaffrohr</li> <li>• Handgriff</li> </ul> <p><b>Complete instrument</b></p> <ul style="list-style-type: none"> <li>• Jaw insert</li> <li>• Sheath</li> <li>• Handle</li> </ul>
	 <p>NL / WL 240 mm</p>	<p>NL / WL 330 mm</p>	<p>HF / mono</p> 	<p>mit Sperre, drehbar with locking mechanism, rotatable</p>	
Typen / Types	8390933	8391933	83930074		Typen / Types
 <p>8390207</p>	●			●	<b>83902077</b>
<p>Greif- und Dissektionszange, links gebogen, doppelbeweglich, MTL= 15 mm <i>Grasping and dissecting forceps, long, fine tip, double jaw action, JL= 15mm</i></p> <p>8391207</p>		●		●	<b>83912077</b>
 <p>8390216</p>	●			●	<b>83902167</b>
<p>Doppellöffelzange, nach Hürtgen MTL= 12 mm <i>Double-spoon forceps, by Hürtgen, JL= 12 mm</i></p> <p>8391216</p>		●		●	<b>83912167</b>
 <p>8390217</p>	●			●	<b>83902177</b>
<p>Stanze nach Friedel, MTL= 10 mm <i>Punch by Friedel, JL= 10 mm</i></p> <p>8391217</p>		●		●	<b>83912177</b>





\* JL = Jaw length when jaws closed (approximate measurements)





\* MTL = Maulteillänge bei geschlossenem Maulteil (gerundete Angaben)



**ERAGON** modular  
*mini*  
modular instruments 3.5 mm

**ERAGON** modular  
*mini*  
modulare Instrumente 3,5 mm

 Alle Innenteile und Schaftrohre sind ebenfalls mit <b>ERAGONaxial</b> kombinierbar. <i>All jaw inserts and sheaths can also be combined with ERAGONaxial.</i>	Griffvarianten / Handle type		Drehradaufsatz, <b>ERAGONaxial</b> <i>Knob attachment, ERAGONaxial</i>  autoklavierbar / <i>autoclavable</i>
			
Typen / Types	83930082	83930085	8988





Innenteil <i>Jaw insert</i>  MTL / JL*	Schaftrohr, unisoliert <i>Sheath tube, uninsulated</i>		Griffvarianten / Handle type	<b>Komplett-Instrument</b> • Innenteil • Schaftrohr • Handgriff <b>Complete instrument</b> • Jaw insert • Sheath • Handle
	NL / WL 240 mm	NL / WL 330 mm		
Typen / Types	8390934	8391934	83930072	Typen / Types
	8390208	●	●	<b>83902087</b>
Atraumatische Greifzange, gefensterter, doppelbeweglich MTL= 14 mm <b>Atraumatic grasping forceps,</b> <i>fenestrated, double jaw action</i> JL= 14 mm	8391208	●	●	<b>83912087</b>
	8390218	●	●	<b>83902187</b>
Atraumatische Greifzange, gefensterter, einfach beweglich MTL= 17 mm <b>Atraumatic grasping forceps,</b> <i>fenestrated, single jaw action</i> JL= 17 mm	8391218	●	●	<b>83912187</b>
	8390225	●	●	<b>83902257</b>
Atraumatische Greifzange, doppelt gefensterter, gebogen, einfach beweglich MTL= 17 mm <b>Atraumatic grasping forceps,</b> <i>double fenestrated, curved, single jaw action</i> JL= 17 mm	8391225	●	●	<b>83912257</b>







\* JL = Jaw length when jaws closed (approximate measurements)

\* MTL = Maulteillänge bei geschlossenem Maulteil (gerundete Angaben)

**ERAGON** modular  
*mini*  
modular instruments 3.5 mm

**ERAGON** modular  
*mini*  
modulare Instrumente 3,5 mm

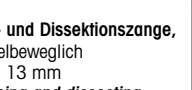
 Alle Innenteile und Schaffrohre sind ebenfalls mit <b>ERAGONaxial</b> kombinierbar. <i>All jaw inserts and sheaths can also be combined with <b>ERAGONaxial</b>.</i>	Griffvarianten / Handle type		Drehradaufsatz, ERAGONaxial Knob attachment, ERAGONaxial  autoklavierbar / autoclavable
	 mit Sperre, drehbar <i>without locking mechanism, rotatable</i>	 mit Sperre, nicht drehbar <i>with locking mechanism, not rotatable</i>	
Typen / Types	83930082	83930085	8988

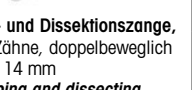

Innenteil <i>Jaw insert</i>  MTL / JL	Schaffrohr, unisoliert <i>Sheath tube, uninsulated</i>		Griffvarianten / Handle type	<b>Komplett-Instrument</b> • Innenteil • Schaffrohr • Handgriff <b>Complete instrument</b> • Jaw insert • Sheath • Handle
	NL / WL 240 mm	NL / WL 330 mm		
Typen / Types	8390934	8391934	83930072	Typen / Types
 <b>Atraumatische Greifzange,</b> gefensternt, doppelbeweglich MTL= 19 mm <b>Atraumatic grasping forceps,</b> fenestrated, double jaw action JL= 19 mm	8390226	●	●	<b>83902267</b>
 <b>Atraumatische Greifzange,</b> gefensternt, doppelbeweglich MTL= 19 mm <b>Atraumatic grasping forceps,</b> fenestrated, double jaw action JL= 19 mm	8391226	●	●	<b>83912267</b>
 <b>Greif- und Dissektionszange,</b> doppelbeweglich MTL= 13 mm <b>Grasping and dissecting forceps,</b> double jaw action JL= 13 mm	8390219	●	●	<b>83902197</b>
 <b>Greif- und Dissektionszange,</b> doppelbeweglich MTL= 13 mm <b>Grasping and dissecting forceps,</b> double jaw action JL= 13 mm	8391219	●	●	<b>83912197</b>
 <b>Greif- und Dissektionszange,</b> 2x4 Zähne, doppelbeweglich MTL= 14 mm <b>Grasping and dissecting forceps,</b> 2x4 teeth, double jaw action JL= 14 mm	8390220	●	●	<b>83902207</b>
 <b>Greif- und Dissektionszange,</b> 2x4 Zähne, doppelbeweglich MTL= 14 mm <b>Grasping and dissecting forceps,</b> 2x4 teeth, double jaw action JL= 14 mm	8391220	●	●	<b>83912207</b>





\* JL = Jaw length when jaws closed (approximate measurements)

\* MTL = Maulteillänge bei geschlossenem Maulteil (gerundete Angaben)

**ERAGON** modular mini  
modular instruments 3.5 mm

**ERAGON** modular mini  
modulare Instrumente 3,5 mm

<p><b>ERAGON</b> axial</p> <p>Alle Innenteile und Schaftrohre sind ebenfalls mit <b>ERAGONaxial</b> kombinierbar. All jaw inserts and sheaths can also be combined with <b>ERAGONaxial</b>.</p>	Griffvarianten / Handle type		<p>Drehradaufsatz, ERAGONaxial Knob attachment, ERAGONaxial</p>  <p>autoklavierbar / autoclavable</p>
			
Typen / Types	83930082	83930085	8988





<p>Innenteil Jaw insert</p> 	Schaftrohr, unisoliert Sheath tube, uninsulated		Griffvarianten / Handle type		<p><b>Komplett-Instrument</b></p> <ul style="list-style-type: none"> <li>• Innenteil</li> <li>• Schaftrohr</li> <li>• Handgriff</li> </ul> <p><b>Complete instrument</b></p> <ul style="list-style-type: none"> <li>• Jaw insert</li> <li>• Sheath</li> <li>• Handle</li> </ul>
		NL / WL 240 mm	NL / WL 330 mm		
Typen / Types	8390934	8391934	83930072		Typen / Types
<p></p> <p><b>Universal-Greifzange, doppelbeweglich</b> MTL= 14 mm <b>Universal grasping forceps, double jaw action</b> JL= 14 mm</p>	8390209	●		●	<b>83902097</b>
	8391209		●	●	<b>83912097</b>
<p></p> <p><b>Greifzange "Babcock", doppelbeweglich</b> MTL= 19 mm <b>Grasping forceps "Babcock", double jaw action</b> JL= 19 mm</p>	8390210	●		●	<b>83902107</b>
	8391210		●	●	<b>83912107</b>

\* JL = Jaw length when jaws closed (approximate measurements)

\* MTL = Maulteillänge bei geschlossenem Maulteil (gerundete Angaben)

**ERAGON modular mini**  
modular instruments 3.5 mm

**ERAGON modular mini**  
modulare Instrumente 3,5 mm

Innenteil Jaw insert   MTL / JL*	Schaffrohr, isoliert Sheath tube, insulated  		Griffvarianten / Handle type   HF / mono		<b>Komplett-Instrument</b> • Innenteil • Schaffrohr • Handgriff  <b>Complete instrument</b> • Jaw insert • Sheath • Handle
	ohne Sperre, drehbar without locking mechanism, rotatable		Typen / Types		
	NL / WL 240 mm	NL / WL 330 mm	83930083		Typen / Types
	Typen / Types	8390933	8391933		
  <b>SAXENA Polyrus-Spreizer</b> , doppelbeweglich MTL= 14 mm <b>SAXENA Pyloric spreader</b> , double jaw action JL= 14 mm	8390228	●		●	<b>83902287</b>
	8391228		●	●	<b>83912287</b>

\* JL = Jaw length when jaws closed (approximate measurements)

\* MTL = Maulteillänge bei geschlossenem Maulteil (gerundete Angaben)



Optional:  
**Drehradaufsatz ERAGON axial**, autoklavierbar ..... 8988

Optional:  
**Knob attachment, ERAGON axial autoclavable** ..... 8988

HF connecting cable see page BDE 163.





HF-Anschlusskabel siehe Blatt BDE 163.







**ERAGON** modular

modular instruments 5 mm

**ERAGON** modular

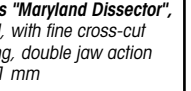
modulare Instrumente 5 mm

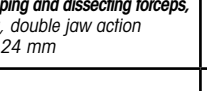
<p><b>ERAGON</b> axial</p> <p>Alle Innenteile und Schaftröhre sind ebenfalls mit <b>ERAGONaxial</b> kombinierbar. <i>All jaw inserts and sheaths can also be combined with ERAGONaxial.</i></p>	Griffvarianten / Handle type				<p>Drehradaufsatz, <b>ERAGONaxial Knob attachment, ERAGONaxial</b></p>  <p>autoklavierbar / autoclavable</p>
	 mit Sperre, drehbar <i>with locking mechanism, rotatable</i>	 HF / mono ohne Sperre, drehbar <i>without locking mechanism, rotatable</i>	 HF / mono mit Sperre, drehbar <i>with locking mechanism, rotatable</i>	 mit Sperre, nicht drehbar <i>with locking mechanism, not rotatable</i>	
Typen / Types	83930082	83930083	83930084	83930085	8988

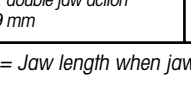
<p>Innenteil <i>Jaw insert</i></p>  <p>MTL / JL*</p>	Schaftröhre, isoliert <i>Sheath tube, insulated</i>		Griffvarianten / Handle type		<p><b>Komplett-Instrument</b></p> <ul style="list-style-type: none"> <li>• Innenteil</li> <li>• Schaftröhre</li> <li>• Handgriff</li> </ul> <p><b>Complete instrument</b></p> <ul style="list-style-type: none"> <li>• Jaw insert</li> <li>• Sheath</li> <li>• Handle</li> </ul>
		NL / WL 330 mm	NL / WL 450 mm	HF / mono	
Typen / Types	8393933	8394933	83930074		Typen / Types
 <p>Greif- und Dissektionszange "Maryland Dissektor", gebogen, mit feiner Verzahnung, doppelbeweglich, MTL= 21 mm <i>Grasping and dissecting forceps "Maryland Dissector", curved, with fine cross-cut toothing, double jaw action JL= 21 mm</i></p>	8393.281	●		●	<b>83932817</b>
 <p>Greif- und Dissektionszange "Maryland Dissektor", gebogen, mit feiner Verzahnung, doppelbeweglich, MTL= 21 mm <i>Grasping and dissecting forceps "Maryland Dissector", curved, with fine cross-cut toothing, double jaw action JL= 21 mm</i></p>	8394.281		●	●	<b>83942817</b>
 <p>Greif- und Dissektionszange, lang, doppelbeweglich MTL= 24 mm <i>Grasping and dissecting forceps, long, double jaw action JL= 24 mm</i></p>	8393194	●		●	<b>83931947</b>
 <p>Greif- und Dissektionszange, lang, doppelbeweglich MTL= 24 mm <i>Grasping and dissecting forceps, long, double jaw action JL= 24 mm</i></p>	8394194		●	●	<b>83941947</b>
 <p>Greif- und Dissektionszange, gebogen, doppelbeweglich, MTL= 19 mm <i>Grasping and dissecting forceps, curved, double jaw action JL= 19 mm</i></p>	8393240	●		●	<b>83932407</b>
 <p>Greif- und Dissektionszange, gebogen, doppelbeweglich, MTL= 19 mm <i>Grasping and dissecting forceps, curved, double jaw action JL= 19 mm</i></p>	8394240		●	●	<b>83942407</b>

\* JL = Jaw length when jaws closed (approximate measurements)





\* MTL = Maulteillänge bei geschlossenem Maulteil (gerundete Angaben)





HF connecting cable see page BDE 163.

HF-Anschlusskabel siehe Blatt BDE 163.

**ERAGON** modular  
modular instruments 5 mm

**ERAGON** modular  
modulare Instrumente 5 mm

<p><b>ERAGON</b> axial</p> <p>Alle Innenteile und Schaffrohre sind ebenfalls mit <b>ERAGONaxial</b> kombinierbar. <i>All jaw inserts and sheaths can also be combined with <b>ERAGONaxial</b>.</i></p>	Griffvarianten / Handle type				<p>Drehradaufsatz, <b>ERAGONaxial</b> Knob attachment, <b>ERAGONaxial</b></p>  <p>autoklavierbar / autoclavable</p>
	 <p>mit Sperre, drehbar with locking mechanism, rotatable</p>	 <p>HF / mono ohne Sperre, drehbar without locking mechanism, rotatable</p>	 <p>HF / mono mit Sperre, drehbar with locking mechanism, rotatable</p>	 <p>mit Sperre, nicht drehbar with locking mechanism, not rotatable</p>	
Typen / Types	83930082	83930083	83930084	83930085	8988





<p>Innenteil <i>Jaw insert</i></p>  <p>MTL / JL*</p>	Schaffrohr, isoliert <i>Sheath tube, insulated</i>		Griffvarianten / Handle type		<p><b>Komplett-Instrument</b></p> <ul style="list-style-type: none"> <li>• Innenteil</li> <li>• Schaffrohr</li> <li>• Handgriff</li> </ul> <p><b>Complete instrument</b></p> <ul style="list-style-type: none"> <li>• Jaw insert</li> <li>• Sheath</li> <li>• Handle</li> </ul>
	NL / WL 330 mm	NL / WL 450 mm	HF / mono	mit Sperre, drehbar <i>with locking mechanism, rotatable</i>	
Typen / Types	8393933	8394933	83930074		Typen / Types
 <p><b>Greif- und Dissektionszange "Mixer"</b>, abgewinkelt, feine pyramidenförmige Verzahnung, doppelbeweglich, MTL= 22 mm <i>Grasping and dissecting forceps "Mixer", angled, fine pyramidal-shaped teeth, double jaw action, JL= 22 mm</i></p>	8393.283	●		●	<b>83932837</b>
 <p><b>Greif- und Dissektionszange</b>, rechtwinklig gebogen, doppelbeweglich, MTL= 18 mm <i>Grasping and dissecting forceps, right-angled, double jaw action, JL= 18 mm</i></p>	8393192	●		●	<b>83931927</b>
	8394192		●	●	<b>83941927</b>
 <p><b>Greif- und Dissektionszange</b>, kurz, feine Spitze, doppelbeweglich, MTL= 19 mm <i>Grasping and dissecting forceps, short, fine tip, double jaw action, JL= 19 mm</i></p>	8393200	●		●	<b>83932007</b>
	8394200		●	●	<b>83942007</b>







\* JL = Jaw length when jaws closed (approximate measurements)

\* MTL = Maulteillänge bei geschlossenem Maulteil (gerundete Angaben)

**ERAGON** modular  
modular instruments 5 mm

**ERAGON** modular  
modulare Instrumente 5 mm

<p><b>ERAGON</b> axial</p> <p>Alle Innenteile und Schaftröhre sind ebenfalls mit <b>ERAGONaxial</b> kombinierbar. <i>All jaw inserts and sheaths can also be combined with ERAGONaxial.</i></p>	Griffvarianten / Handle type				<p>Drehradaufsatz, <b>ERAGONaxial Knob attachment, ERAGONaxial</b></p>  <p>autoklavierbar / autoclavable</p>
	 <p>mit Sperre, drehbar with locking mechanism, rotatable</p>	 <p>HF / mono ohne Sperre, drehbar without locking mechanism, rotatable</p>	 <p>HF / mono mit Sperre, drehbar with locking mechanism, rotatable</p>	 <p>mit Sperre, nicht drehbar with locking mechanism, not rotatable</p>	
Typen / Types	83930082	83930083	83930084	83930085	

<p>Innenteil Jaw insert</p>  <p>MTL / JL*</p>	Schaftröhre, isoliert Sheath tube, insulated		Griffvarianten / Handle type		<p><b>Komplett-Instrument</b></p> <ul style="list-style-type: none"> <li>• Innenteil</li> <li>• Schaftröhre</li> <li>• Handgriff</li> </ul> <p><b>Complete instrument</b></p> <ul style="list-style-type: none"> <li>• Jaw insert</li> <li>• Sheath</li> <li>• Handle</li> </ul>
		 <p>NL / WL 330 mm</p>	 <p>NL / WL 450 mm</p>	 <p>HF / mono</p>	
Typen / Types	8393933	8394933	83930074		Typen / Types
 <p>8393197</p>	●		●		83931977
<p>Greif- und Dissektionszange, lang, doppelbeweglich, MTL= 30 mm <i>Grasping and dissecting, long, double jaw action JL= 30 mm</i></p>	8394197		●		83941977
 <p>8393198</p>	●		●		83931987
<p>Greifzange, gebogen, feine Spitze, doppelbeweglich, MTL= 33 mm <i>Grasping forceps, curved, fine tip, double jaw action, JL= 33 mm</i></p>	8394198		●		83941987
 <p>8393199</p>	●		●		83931997
<p>Greif- und Dissektionszange lang, feine Spitze, doppelbeweglich, MTL= 32 mm <i>Grasping and dissecting forceps long, fine tip, double jaw action, JL= 32 mm</i></p>	8394199		●		83941997

\* JL = Jaw length when jaws closed (approximate measurements)





\* MTL = Maulteillänge bei geschlossenem Maulteil (gerundete Angaben)







HF connecting cable see page BDE 163.

HF-Anschlusskabel siehe Blatt BDE 163.

**ERAGON** modular  
modular instruments 5 mm

**ERAGON** modular  
modulare Instrumente 5 mm

<p><b>ERAGON</b> axial</p> <p>Alle Innenteile und Schaffrohre sind ebenfalls mit <b>ERAGONaxial</b> kombinierbar. <i>All jaw inserts and sheaths can also be combined with <b>ERAGONaxial</b>.</i></p>	Griffvarianten / Handle type				<p>Drehradaufsatz, <b>ERAGONaxial</b> Knob attachment, <b>ERAGONaxial</b></p>  <p>autoklavierbar / autoclavable</p>
	 <p>mit Sperre, drehbar with locking mechanism, rotatable</p>	 <p>HF / mono ohne Sperre, drehbar without locking mechanism, rotatable</p>	 <p>HF / mono mit Sperre, drehbar with locking mechanism, rotatable</p>	 <p>mit Sperre, nicht drehbar with locking mechanism, not rotatable</p>	
Typen / Types	83930082	83930083	83930084	83930085	8988

<p>Innenteil <i>Jaw insert</i></p>  <p>MTL / JL*</p>	<p>Schaffrohr, isoliert <i>Sheath tube, insulated</i></p>  <p>NL / WL 330 mm</p>	Griffvarianten / Handle type		<p><b>Komplett-Instrument</b></p> <ul style="list-style-type: none"> <li>• Innenteil</li> <li>• Schaffrohr</li> <li>• Handgriff</li> </ul> <p><b>Complete instrument</b></p> <ul style="list-style-type: none"> <li>• Jaw insert</li> <li>• Sheath</li> <li>• Handle</li> </ul>
		 <p>HF mono ohne Sperre, drehbar without locking mechanism, rotatable</p>	 <p>HF mono mit Sperre, drehbar with locking mechanism, rotatable</p>	
Typen / Types	8393933	83930073	83930074	Typen / Types
 <p><b>Greif- und Dissektionszange</b>, feine pyramidenförmige Verzahnung, schlank, doppel- beweglich, MTL= 23 mm <b>Grasping and dissecting forceps</b>, fine pyramid-shaped toothing, slimline, double action, JL= 23 mm</p>	8393.289	●	●	<b>83932897</b>
 <p><b>Dissektionszange "Petelin"</b>, 30° links abgewinkelt, mit Querverzahnung, einseitig beweglich, MTL= 17 mm <b>Dissecting forceps "Petelin"</b>, angled 30° left, with horizon- tal serration, single jaw action, JL= 17 mm</p>	8393.282	●	●	<b>83932827</b>
 <p><b>Greif- und Dissektionszange "Dolphin"</b>, abgewinkelt, feine Querverzahnung, mit Maulkehle, schlank, MTL= 17 mm <b>Grasping and dissecting forceps, "Dolphin"</b>, angled, fine cross-cut toothing, with jaw throat, slimline, double jaw action, JL= 17 mm</p>	8393.285	●	●	<b>83932857</b>





\* JL = Jaw length when jaws closed (approximate measurements)











\* MTL = Maulteillänge bei geschlossenem Maulteil (gerundete Angaben)

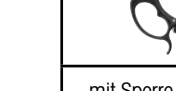

**ERAGON** modular  
modular instruments 5 mm

**ERAGON** modular  
modulare Instrumente 5 mm

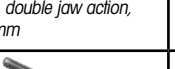
<p><b>ERAGON</b> axial</p> <p>Alle Innenteile und Schaftröhre sind ebenfalls mit <b>ERAGONaxial</b> kombinierbar. <i>All jaw inserts and sheaths can also be combined with ERAGONaxial.</i></p>	Griffvarianten / Handle type				<p>Drehradaufsatz, <b>ERAGONaxial Knob attachment, ERAGONaxial</b></p>  <p>autoklavierbar / autoclavable</p>
	 <p>mit Sperre, drehbar with locking mechanism, rotatable</p>	 <p>HF / mono ohne Sperre, drehbar without locking mechanism, rotatable</p>	 <p>HF / mono mit Sperre, drehbar with locking mechanism, rotatable</p>	 <p>mit Sperre, nicht drehbar with locking mechanism, not rotatable</p>	
Typen / Types	83930082	83930083	83930084	83930085	8988

<p>Innenteil Jaw insert</p>  <p>MTL / JL*</p>	Schaftröhre, isoliert Sheath tube, insulated			Griffvarianten / Handle type		<p><b>Komplett-Instrument</b></p> <ul style="list-style-type: none"> <li>• Innenteil</li> <li>• Schaftröhre</li> <li>• Handgriff</li> </ul> <p><b>Complete instrument</b></p> <ul style="list-style-type: none"> <li>• Jaw insert</li> <li>• Sheath</li> <li>• Handle</li> </ul>			
					 <p>mit Sperre, drehbar with locking mechanism, rotatable</p>		 <p>HF mono mit Sperre, drehbar with locking mechanism, rotatable</p>		
Typen / Types	NL / WL 260 mm	NL / WL 330 mm	NL / WL 450 mm	8392933	8393933	8394933	83930072	83930074	Typen / Types
 <p><b>Greif- und Dissektionszange,</b> kurzes abgerundetes Maulteil, doppelbeweglich, MTL= 15 mm <i>Grasping and dissecting, short rounded jaws, double jaw action, JL= 15 mm</i></p>	8393230								83932307
 <p><b>Greif- und Dissektionszange,</b> kurzes abgerundetes Maulteil, doppelbeweglich, MTL= 15 mm <i>Grasping and dissecting, short rounded jaws, double jaw action, JL= 15 mm</i></p>	8394230								83942307
 <p><b>Atraumatische Greifzange,</b> gefenestert mit Querverzahnung, doppelbeweglich, MTL= 19 mm <i>Atraumatic grasping forceps, fenestrated, with cross-cut toothing, double jaw action, JL= 19 mm</i></p>	8392.181								83921817
 <p><b>Atraumatische Greifzange,</b> gefenestert mit Querverzahnung, doppelbeweglich, MTL= 19 mm <i>Atraumatic grasping forceps, fenestrated, with cross-cut toothing, double jaw action, JL= 19 mm</i></p>	8393.181								83931817
 <p><b>Atraumatische Greifzange,</b> gefenestert mit Querverzahnung, doppelbeweglich, MTL= 19 mm <i>Atraumatic grasping forceps, fenestrated, with cross-cut toothing, double jaw action, JL= 19 mm</i></p>	8394.181								83941817
 <p><b>Tellerfasszange,</b> gefenestert mit feiner Querverzahnung, doppelbeweglich, MTL= 18 mm <i>Plate-shaped grasping forceps, fenestrated with fine cross-cut toothing, double jaw action, JL= 18 mm</i></p>	8393.182								83931827

\* JL = Jaw length when jaws closed (approximate measurements)





\* MTL = Maulteillänge bei geschlossenem Maulteil (gerundete Angaben)







HF connecting cable see page BDE 163.

HF-Anschlusskabel siehe Blatt BDE 163.

**ERAGON** modular  
modular instruments 5 mm

**ERAGON** modular  
modulare Instrumente 5 mm

<p><b>ERAGON</b>axial</p> <p>Alle Innenteile und Schaffrohre sind ebenfalls mit <b>ERAGONaxial</b> kombinierbar. <i>All jaw inserts and sheaths can also be combined with <b>ERAGONaxial</b>.</i></p>	Griffvarianten / Handle type				<p>Drehradaufsatz, <b>ERAGONaxial</b> Knob attachment, <b>ERAGONaxial</b></p>  <p>autoklavierbar / autoclavable</p>
	 <p>mit Sperre, drehbar with locking mechanism, rotatable</p>	 <p>HF / mono ohne Sperre, drehbar without locking mechanism, rotatable</p>	 <p>HF / mono mit Sperre, drehbar with locking mechanism, rotatable</p>	 <p>mit Sperre, nicht drehbar with locking mechanism, not rotatable</p>	
Typen / Types	83930082	83930083	83930084	83930085	8988

<p>Innenteil Jaw insert</p>  <p>MTL / JL*</p>	Schaffrohr, isoliert Sheath tube, insulated		Griffvarianten / Handle type		<p><b>Komplett-Instrument</b></p> <ul style="list-style-type: none"> <li>• Innenteil</li> <li>• Schaffrohr</li> <li>• Handgriff</li> </ul> <p><b>Complete instrument</b></p> <ul style="list-style-type: none"> <li>• Jaw insert</li> <li>• Sheath</li> <li>• Handle</li> </ul>
	 <p>HF mono ohne Sperre, drehbar without locking mechanism, rotatable</p>	 <p>HF mono mit Sperre, drehbar with locking mechanism, rotatable</p>	NL / WL 330 mm	NL / WL 450 mm	
 <p><b>Greif- und Präparierzange</b>, feine Querverzahnung, doppelbeweglich, MTL= 21 mm <b>Grasping and dissecting forceps</b>, fine cross-cut toothing, double jaw action, JL= 21 mm</p>	8393.183	●		●	83931837
 <p><b>Greif- und Dissektionszange</b>, gefenstert mit feiner Querverzahnung, einseitig beweglich MTL= 21 mm <b>Grasping and dissecting forceps</b>, perforated, fine horizontal serrations, single jaw action, JL= 21 mm</p>	8393.185	●		●	83931857
 <p><b>Greif- und Dissektionszange</b>, gefenstert mit feiner Querverzahnung, einseitig beweglich, MTL= 26 mm <b>Grasping and dissecting forceps</b>, perforated, fine horizontal serrations, single jaw action, JL= 26 mm</p>	8393.184	●		●	83931847
	8394.184		●	●	83941847

\* JL = Jaw length when jaws closed (approximate measurements)





\* MTL = Maulteillänge bei geschlossenem Maulteil (gerundete Angaben)





**ERAGON** modular

modular instruments 5 mm

**ERAGON** modular

modulare Instrumente 5 mm

<p><b>ERAGON</b> axial</p> <p>Alle Innenteile und Schaftrohre sind ebenfalls mit <b>ERAGONaxial</b> kombinierbar. All jaw inserts and sheaths can also be combined with <b>ERAGONaxial</b>.</p>	Griffvarianten / Handle type				<p>Drehradaufsatz, <b>ERAGONaxial</b> Knob attachment, <b>ERAGONaxial</b></p>  <p>autoklavierbar / autoclavable</p>
	 <p>mit Sperre, drehbar with locking mechanism, rotatable</p>	 <p>HF / mono ohne Sperre, drehbar without locking mechanism, rotatable</p>	 <p>HF / mono mit Sperre, drehbar with locking mechanism, rotatable</p>	 <p>mit Sperre, nicht drehbar with locking mechanism, not rotatable</p>	
Typen / Types	83930082	83930083	83930084	83930085	8988

<p>Innenteil Jaw insert</p>  <p>MTL / JL*</p>	Schaftrohr, isoliert Sheath tube, insulated		Griffvarianten / Handle type		<p><b>Komplett-Instrument</b></p> <ul style="list-style-type: none"> <li>• Innenteil</li> <li>• Schaftrohr</li> <li>• Handgriff</li> </ul> <p><b>Complete instrument</b></p> <ul style="list-style-type: none"> <li>• Jaw insert</li> <li>• Sheath</li> <li>• Handle</li> </ul>
	NL / WL 330 mm	NL / WL 450 mm	mit Sperre, drehbar with locking mechanism, rotatable		
Typen / Types	8393933	8394933	83930072		Typen / Types
 <p><b>Greifzange,</b> atraumatisch, gefenestert, feine Querverzahnung, doppelbeweglich, MTL= 25 mm <b>Grasping forceps,</b> atraumatic, fenestrated, fine cross toothing double jaw action, JL= 25 mm</p>	8393250	●		●	<b>83932507</b>
	8394250		●	●	<b>83942507</b>
 <p><b>Atraumatische Greifzange,</b> doppelt gefenestert, gebogen, einfach beweglich- MTL= 32 mm <b>Atraumatic grasping forceps,</b> with double window, curved, single jaw action, JL= 32 mm</p>	8393229	●		●	<b>83932297</b>
	8394229		●	●	<b>83942297</b>
 <p><b>Atraumatische Darmfasszange,</b> einfach gefenestert, doppelbeweglich, MTL= 38 mm <b>Atraumatic intestinal grasping forceps,</b> single fenestration, double jaw action JL= 38 mm</p>	8393249	●		●	<b>83932497</b>
	8394249		●	●	<b>83942497</b>

\* JL = Jaw length when jaws closed (approximate measurements)





\* MTL = Maulteillänge bei geschlossenem Maulteil (gerundete Angaben)







HF connecting cable see page BDE 163.

HF-Anschlusskabel siehe Blatt BDE 163.

**ERAGON** modular  
modular instruments 5 mm

**ERAGON** modular  
modulare Instrumente 5 mm

<p><b>ERAGON</b>axial</p> <p>Alle Innenteile und Schaffrohre sind ebenfalls mit <b>ERAGONaxial</b> kombinierbar. All jaw inserts and sheaths can also be combined with <b>ERAGONaxial</b>.</p>	Griffvarianten / Handle type				<p>Drehradaufsatz, <b>ERAGONaxial</b> Knob attachment, <b>ERAGONaxial</b></p>  <p>autoklavierbar / autoclavable</p>
	 <p>mit Sperre, drehbar with locking mechanism, rotatable</p>	 <p>HF / mono ohne Sperre, drehbar without locking mechanism, rotatable</p>	 <p>HF / mono mit Sperre, drehbar with locking mechanism, rotatable</p>	 <p>mit Sperre, nicht drehbar with locking mechanism, not rotatable</p>	
Typen / Types	83930082	83930083	83930084	83930085	8988

<p>Innenenteil Jaw insert</p>  <p>MTL / JL*</p>	Schaffrohr, isoliert Sheath tube, insulated		Griffvarianten / Handle type		<p><b>Komplett-Instrument</b></p> <ul style="list-style-type: none"> <li>• Innenenteil</li> <li>• Schaffrohr</li> <li>• Handgriff</li> </ul> <p><b>Complete instrument</b></p> <ul style="list-style-type: none"> <li>• Jaw insert</li> <li>• Sheath</li> <li>• Handle</li> </ul>	
	NL / WL 330 mm	NL / WL 450 mm	 <p>mit Sperre, drehbar with locking mechanism, rotatable</p>	 <p>HF mono mit Sperre, drehbar with locking mechanism, rotatable</p>		
Typen / Types	8393933	8394933	83930072	83930074	Typen / Types	
 <p>Greifzange "Debaquey", gebogen, doppelbeweglich MTL= 35 mm <b>Grasping forceps "Debaquey"</b>, curved, double jaw action, JL= 35 mm</p>	8393256	●			●	83932567
 <p>Greifzange "Debaquey", doppelbeweglich, MTL= 47 mm <b>Grasping forceps "Debaquey"</b>, double jaw action, JL= 47 mm</p>	8393258	●			●	83932587
	8394258		●		●	83942587
 <p>Greif- und Präparierzange, feine Querverzahnung, gefensterter, doppelbeweglich, mit federnden Maulteilen, MTL= 47 mm <b>Grasping and dissecting forceps</b>, fine cross-cut toothing, fenestrated, double jaw action, with spring jaws, JL= 47 mm</p>	8393.189	●			●	83931897
	8394.189		●		●	83941897

\* JL = Jaw length when jaws closed (approximate measurements)





\* MTL = Maulteillänge bei geschlossenem Maulteil (gerundete Angaben)







HF connecting cable see page BDE 163.

HF-Anschlusskabel siehe Blatt BDE 163.

**ERAGON** modular  
modular instruments 5 mm

**ERAGON** modular  
modulare Instrumente 5 mm

<p><b>ERAGON</b> axial</p> <p>Alle Innenteile und Schaffrohre sind ebenfalls mit <b>ERAGONaxial</b> kombinierbar. <i>All jaw inserts and sheaths can also be combined with ERAGONaxial.</i></p>	Griffvarianten / Handle type				<p>Drehradaufsatz, <b>ERAGONaxial Knob attachment, ERAGONaxial</b></p>  <p>autoklavierbar / autoclavable</p>
	 <p>mit Sperre, drehbar with locking mechanism, rotatable</p>	 <p>HF / mono ohne Sperre, drehbar without locking mechanism, rotatable</p>	 <p>HF / mono mit Sperre, drehbar with locking mechanism, rotatable</p>	 <p>mit Sperre, nicht drehbar with locking mechanism, not rotatable</p>	
Typen / Types	83930082	83930083	83930084	83930085	

<p>Innenteil Jaw insert</p>  <p>MTL / JL*</p>	<p>Schaffrohr, isoliert Sheath tube, insulated</p>  <p>NL / WL 330 mm</p>	<p>Griffvarianten / Handle type</p> 	<p><b>Komplett-Instrument</b></p> <ul style="list-style-type: none"> <li>• Innenteil</li> <li>• Schaffrohr</li> <li>• Handgriff</li> </ul> <p><b>Complete instrument</b></p> <ul style="list-style-type: none"> <li>• Jaw insert</li> <li>• Sheath</li> <li>• Handle</li> </ul>	
		<p>mit Sperre, drehbar with locking mechanism, rotatable</p>		Typen / Types
Typen / Types	8393933	83930072	Typen / Types	
 <p><b>Greif- und Dissektionszange, atraumatische Klemme "Debaquey",</b> Längsrillen mit feiner Querverzahnung, doppelbeweglich, mit federnden Maulteilen, MTL= 47 mm <b>Grasping and dissecting forceps, atraumatic clip "Debaquey",</b> longitudinal grooves with fine cross-cut toothing, double jaw action, with spring jaws, JL= 47 mm</p>	8393.291	●	●	83932917
 <p><b>Greif- und Dissektionszange "Debaquey",</b> atraumatische Klemme, doppelbeweglich, MTL= 39 mm <b>Grasping and dissecting forceps "Debaquey",</b> atraumatic clip, double jaw action, JL= 39 mm</p>	8393190	●	●	83931907
 <p><b>Greif- und Dissektionszange "Debaquey",</b> atraumatische Klemme, doppelbeweglich, MTL= 48 mm <b>Grasping and dissecting forceps "Debaquey",</b> atraumatic clip, double jaw action, JL= 48 mm</p>	8393191	●	●	83931917

\* JL = Jaw length when jaws closed (approximate measurements)





\* MTL = Maulteillänge bei geschlossenem Maulteil (gerundete Angaben)







HF connecting cable see page BDE 163.

HF-Anschlusskabel siehe Blatt BDE 163.

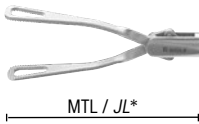
**ERAGON** modular  
modular instruments 5 mm

**ERAGON** modular  
modulare Instrumente 5 mm

<p><b>ERAGON</b>axial</p> <p>Alle Innenteile und Schaffrohre sind ebenfalls mit <b>ERAGONaxial</b> kombinierbar. <i>All jaw inserts and sheaths can also be combined with <b>ERAGONaxial</b>.</i></p>	Griffvarianten / Handle type				<p>Drehradaufsatz, <b>ERAGONaxial Knob attachment, ERAGONaxial</b></p>  <p>autoklavierbar / autoclavable</p>
	 <p>mit Sperre, drehbar with locking mechanism, rotatable</p>	 <p>HF / mono ohne Sperre, drehbar without locking mechanism, rotatable</p>	 <p>HF / mono mit Sperre, drehbar with locking mechanism, rotatable</p>	 <p>mit Sperre, nicht drehbar with locking mechanism, not rotatable</p>	
	83930082	83930083	83930084	83930085	8988





<p>Innenteil <i>Jaw insert</i></p>  <p>MTL / JL*</p>	<p>Schaffrohr, isoliert <i>Sheath tube, insulated</i></p> 		<p>Griffvarianten / Handle type</p> 		<p><b>Komplett-Instrument</b></p> <ul style="list-style-type: none"> <li>• Innenteil</li> <li>• Schaffrohr</li> <li>• Handgriff</li> </ul> <p><b>Complete instrument</b></p> <ul style="list-style-type: none"> <li>• Jaw insert</li> <li>• Sheath</li> <li>• Handle</li> </ul>
	<p>Typen / Types</p>	NL / WL 330 mm	NL / WL 450 mm	<p>mit Sperre, drehbar with locking mechanism, rotatable</p> <p>83930072</p>	
 <p><b>Greif- und Extraktionszange</b>, dreiecksförmig, gefensternt, mit feiner Querverzahnung, doppelbeweglich, mit federnden Maulteilen, MTL= 37 mm <i>Grasping and extraction forceps, triangular, fenestrated, with finecross-cut toothing, double jaw action, with spring jaws, JL= 37 mm</i></p>	8393.188	●		●	<b>83931887</b>
 <p><b>Greifzange "Babcock"</b>, Greiffläche mit feiner Querverzahnung, doppelbeweglich, MTL= 24 mm <i>Grasping forceps "Babcock", grasping surface with fine cross-cut toothing, double jaw action, JL= 24 mm</i></p>	8393.186	●		●	<b>83931867</b>
 <p><b>Greifzange "Babcock"</b>, große distale Greiffläche mit feiner Querverzahnung, doppelbeweglich, MTL= 26 mm <i>Grasping forceps "Babcock", grasping surface with fine cross-cut toothing, double jaw action, JL= 26 mm</i></p>	8393.187	●		●	<b>83931877</b>
	8394.187		●	●	<b>83941877</b>







\* JL = Jaw length when jaws closed (approximate measurements)

\* MTL = Maulteillänge bei geschlossenem Maulteil (gerundete Angaben)

**ERAGON** modular  
modular instruments 5 mm

**ERAGON** modular  
modulare Instrumente 5 mm

<p><b>ERAGON</b>axial</p> <p>Alle Innenteile und Schaftröhre sind ebenfalls mit <b>ERAGONaxial</b> kombinierbar. <i>All jaw inserts and sheaths can also be combined with ERAGONaxial.</i></p>	Griffvarianten / Handle type				<p>Drehradaufsatz, <b>ERAGONaxial Knob attachment, ERAGONaxial</b></p>  <p>autoklavierbar / autoclavable</p>
	 <p>mit Sperre, drehbar with locking mechanism, rotatable</p>	 <p>HF / mono ohne Sperre, drehbar without locking mechanism, rotatable</p>	 <p>HF / mono mit Sperre, drehbar with locking mechanism, rotatable</p>	 <p>mit Sperre, nicht drehbar with locking mechanism, not rotatable</p>	
Typen / Types	83930082	83930083	83930084	83930085	8988

<p>Innenteil Jaw insert</p>  <p>MTL / JL*</p>	Schaftröhre, isoliert Sheath tube, insulated		Griffvarianten / Handle type			<p><b>Komplett-Instrument</b></p> <ul style="list-style-type: none"> <li>• Innenteil</li> <li>• Schaftröhre</li> <li>• Handgriff</li> </ul> <p><b>Complete instrument</b></p> <ul style="list-style-type: none"> <li>• Jaw insert</li> <li>• Sheath</li> <li>• Handle</li> </ul>
	NL / WL 330 mm	NL / WL 450 mm	 <p>mit Sperre, drehbar with locking mechanism, rotatable</p>	 <p>ohne Sperre, drehbar without locking mechanism, rotatable</p>	 <p>mit Sperre, drehbar with locking mechanism, rotatable</p>	
Typen / Types	8393933	8394933	83930072	83930073	83930074	Typen / Types
 <p><b>Greifzange "Babcock",</b> gefenestert, einfach beweglich, MTL= 17 mm <b>Grasping forceps "Babcock",</b> fenestrated, single jaw action JL= 17 mm</p>	8393242	●		●		<b>83932427</b>
	8394242		●	●		<b>83942427</b>
 <p><b>Universal-Greifzange,</b> pyramidenförmige Verzahnung und Querverzahnung, doppelbeweglich, MTL= 18 mm <b>Universal grasping forceps,</b> pyramid-shaped toothing and cross-cut toothing, double jaw action, JL= 18 mm</p>	8393.481	●			●	<b>83934817</b>
 <p><b>Universal-Greifzange,</b> pyramidenförmige Verzahnung und Querverzahnung, doppel- beweglich, MTL= 26 mm <b>Universal holding forceps,</b> Pyramid-shaped toothing and cross-cut toothing, double jaw action JL= 26 mm</p>	8394.482		●		●	<b>83944827</b>

\* JL = Jaw length when jaws closed (approximate measurements)





\* MTL = Maulteillänge bei geschlossenem Maulteil (gerundete Angaben)





HF connecting cable see page BDE 163.

HF-Anschlusskabel siehe Blatt BDE 163.

**ERAGON** modular  
modular instruments 5 mm

**ERAGON** modular  
modulare Instrumente 5 mm

<b>ERAGON</b> axial	Griffvarianten / Handle type				Drehradaufsatz, ERAGONaxial Knob attachment, ERAGONaxial  autoklavierbar / autoclavable	
	 mit Sperre, drehbar with locking mechanism, rotatable	 HF / mono ohne Sperre, drehbar without locking mechanism, rotatable	 HF / mono mit Sperre, drehbar with locking mechanism, rotatable	 mit Sperre, nicht drehbar with locking mechanism, not rotatable		
Alle Innenteile und Schaffrohre sind ebenfalls mit <b>ERAGONaxial</b> kombinierbar. All jaw inserts and sheaths can also be combined with <b>ERAGONaxial</b> .	Typen / Types	83930082	83930083	83930084	83930085	8988

Innenteil Jaw insert  MTL / JL*	Schaffrohr, isoliert Sheath tube, insulated		Griffvarianten / Handle type		Komplett- Instrument • Innenteil • Schaffrohr • Handgriff  Complete instrument • Jaw insert • Sheath • Handle	
	NL / WL 330 mm	NL / WL 450 mm	mit Sperre, drehbar with locking mechanism, rotatable			Typen / Types
	Typen / Types	8393933	8394933	83930072		Typen / Types
 <b>Greifzange,</b> atraumatisch, feine Querver- zahnung, doppelbeweglich, MTL= 29 mm <b>Grasping forceps,</b> atraumatic, fine cross toothing, double jaw action, JL= 29 mm	8393223	●		●		<b>83932237</b>
	8394223		●	●		<b>83942237</b>
 <b>Atraumatische Greifzange,</b> Maulkehle mit gewelltem Zahnrand, einfach beweglich, MTL= 26 mm <b>Atraumatic grasping forceps,</b> jaw throat with wavy tooth edge, single jaw action, JL= 26 mm	8393.292	●		●		<b>83932925</b>
	8394.292		●	●		<b>83942925</b>
 <b>Atraumatische Greifzange,</b> Maulkehle mit gewelltem Zahnrand, doppelbeweglich, MTL= 26 mm <b>Atraumatic grasping forceps,</b> jaw throat with wavy tooth edge, double jaw action, JL= 26 mm	8393.293	●		●		<b>83932935</b>
	8394.293		●	●		<b>83942935</b>





\* JL = Jaw length when jaws closed (approximate measurements)







\* MTL = Maulteillänge bei geschlossenem Maulteil (gerundete Angaben)



**ERAGON** modular  
modular instruments 5 mm

**ERAGON** modular  
modulare Instrumente 5 mm

<p><b>ERAGON</b>axial</p> <p>Alle Innenteile und Schaftrohre sind ebenfalls mit <b>ERAGONaxial</b> kombinierbar. <i>All jaw inserts and sheaths can also be combined with <b>ERAGONaxial</b>.</i></p>	Griffvarianten / Handle type				<p>Drehradaufsatz, <b>ERAGONaxial</b> Knob attachment, <b>ERAGONaxial</b></p>  <p>autoklavierbar / autoclavable</p>
	 <p>mit Sperre, drehbar with locking mechanism, rotatable</p>	 <p>HF / mono ohne Sperre, drehbar without locking mechanism, rotatable</p>	 <p>HF / mono mit Sperre, drehbar with locking mechanism, rotatable</p>	 <p>mit Sperre, nicht drehbar with locking mechanism, not rotatable</p>	
Typen / Types	83930082	83930083	83930084	83930085	

<p>Innenteil Jaw insert</p>  <p>MTL / JL*</p>	<p>Schaftrohr, isoliert Sheath tube, insulated</p>  <p>NL / WL 330 mm</p>	Griffvarianten / Handle type		<p><b>Komplett-Instrument</b></p> <ul style="list-style-type: none"> <li>• Innenteil</li> <li>• Schaftrohr</li> <li>• Handgriff</li> </ul> <p><b>Complete instrument</b></p> <ul style="list-style-type: none"> <li>• Jaw insert</li> <li>• Sheath</li> <li>• Handle</li> </ul>
		 <p>HF / mono</p>	<p>mit Sperre, drehbar with locking mechanism, rotatable</p>	
Typen / Types	8393933	83930074		
 <p><b>Greif- und Dissektionszange</b>, feine pyramidenförmige Verzahnung, schlank, doppelbeweglich, MTL= 19 mm <b>Grasping and dissecting forceps</b>, fine pyramid-shaped toothing, slimline, double jaw action, JL= 19 mm</p>	8393.288	●	●	<b>83932887</b>
 <p><b>Greifzange</b>, mit Zahnreihe, doppelbeweglich, MTL= 17 mm <b>Grasping forceps</b> with row of teeth, double jaw action, JL= 17 mm</p>	8393.485	●	●	<b>83934857</b>
 <p><b>Greif- und Präparierzange</b>, atraumatisch, feine Querverzahnung, doppelbeweglich, MTL= 16 mm <b>Grasping and dissecting forceps</b>, atraumatic, fine cross toothing, double jaw action, JL= 16 mm</p>	8393210	●	●	<b>83932107</b>

\* JL = Jaw length when jaws closed (approximate measurements)





\* MTL = Maulteillänge bei geschlossenem Maulteil (gerundete Angaben)









HF connecting cable see page BDE 163.

HF-Anschlusskabel siehe Blatt BDE 163.

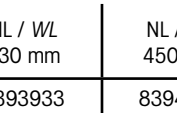
**ERAGON** modular  
modular instruments 5 mm

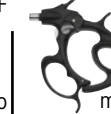
**ERAGON** modular  
modulare Instrumente 5 mm

<p><b>ERAGON</b>axial</p> <p>Alle Innenteile und Schaffrohre sind ebenfalls mit <b>ERAGONaxial</b> kombinierbar. <i>All jaw inserts and sheaths can also be combined with <b>ERAGONaxial</b>.</i></p>	Griffvarianten / Handle type				<p>Drehradaufsatz, <b>ERAGONaxial Knob attachment, ERAGONaxial</b></p>  <p>autoklavierbar / autoclavable</p>
	 mit Sperre, drehbar with locking mechanism, rotatable	 HF / mono ohne Sperre, drehbar without locking mechanism, rotatable	 HF / mono mit Sperre, drehbar with locking mechanism, rotatable	 mit Sperre, nicht drehbar with locking mechanism, not rotatable	
Typen / Types	83930082	83930083	83930084	83930085	8988

<p>Innenteil <i>Jaw insert</i></p>  <p>MTL / JL*</p>	Schaffrohr, isoliert <i>Sheath tube, insulated</i>		Griffvarianten / Handle type			<p><b>Komplett-Instrument</b></p> <ul style="list-style-type: none"> <li>• Innenteil</li> <li>• Schaffrohr</li> <li>• Handgriff</li> </ul> <p><b>Complete instrument</b></p> <ul style="list-style-type: none"> <li>• Jaw insert</li> <li>• Sheath</li> <li>• Handle</li> </ul>
	 NL / WL 330 mm	 NL / WL 450 mm	 mit Sperre, drehbar with locking mechanism, rotatable	 ohne Sperre, drehbar without locking mechanism, rotatable	 HF mit Sperre, drehbar with locking mechanism, rotatable	
Typen / Types	8393933	8394933	83930072	83930073	83930074	Typen / Types
 8393193	●		●			<b>83931937</b>
<p>Greif- und Dissektionszange, doppelbeweglich, MTL= 16 mm <i>Grasping and dissecting forceps, double jaw action, JL= 16 mm</i></p>	8394193		●	●		<b>83941937</b>
 8393220	●				●	<b>83932207</b>
<p>Greif- und Präparierzange, atraumatisch, doppelbeweglich, MTL= 19 mm <i>Grasping and dissecting forceps, atraumatic, double jaw action, JL= 19 mm</i></p>	8394220		●		●	<b>83942207</b>
 8393.195	●			●		<b>83931957</b>
<p>Atraumatische Greifzange, glatt, doppelbeweglich, MTL= 18 mm <i>Atraumatic grasping forceps, smooth, double jaw action, JL= 18 mm</i></p>	8394.195		●	●		<b>83941957</b>

\* JL = Jaw length when jaws closed (approximate measurements)





\* MTL = Maulteillänge bei geschlossenem Maulteil (gerundete Angaben)







**ERAGON** modular

modular instruments 5 mm

**ERAGON** modular

modulare Instrumente 5 mm

<p><b>ERAGON</b> axial</p> <p>Alle Innenteile und Schaftrohre sind ebenfalls mit <b>ERAGONaxial</b> kombinierbar. All jaw inserts and sheaths can also be combined with <b>ERAGONaxial</b>.</p>	Griffvarianten / Handle type				<p>Drehradaufsatz, <b>ERAGONaxial Knob attachment, ERAGONaxial</b></p>  <p>autoklavierbar / autoclavable</p>
	 mit Sperre, drehbar with locking mechanism, rotatable	 HF / mono ohne Sperre, drehbar without locking mechanism, rotatable	 HF / mono mit Sperre, drehbar with locking mechanism, rotatable	 mit Sperre, nicht drehbar with locking mechanism, not rotatable	
Typen / Types	83930082	83930083	83930084	83930085	8988

<p>Innenteil Jaw insert</p>  <p>MTL / JL*</p>	<p>Schaftrohr, isoliert Sheath tube, insulated</p>  <p>NL / WL 330 mm</p>	Griffvarianten / Handle type		<p><b>Komplett-Instrument</b></p> <ul style="list-style-type: none"> <li>• Innenteil</li> <li>• Schaftrohr</li> <li>• Handgriff</li> </ul> <p><b>Complete instrument</b></p> <ul style="list-style-type: none"> <li>• Jaw insert</li> <li>• Sheath</li> <li>• Handle</li> </ul>
		<p>HF / mono</p> 	<p>mit Sperre, drehbar with locking mechanism, rotatable</p>	
Typen / Types	8393933	83930074		83934867
 <p><b>Griffzange,</b> mit einem Zahn, feine Querverzahnung, schlank, doppelbeweglich, MTL= 19 mm <b>Grasping forceps,</b> with one tooth, fine cross-cut toothing, slimline, double jaw action, JL= 19 mm</p>	8393.486	●	●	83934867
 <p><b>Griffzange,</b> mit zwei Zähnen, feine Querverzahnung, einfach beweglich, MTL= 17 mm <b>Grasping forceps,</b> with two teeth, fine cross-cut toothing, single jaw action, JL= 17 mm</p>	8393.487	●	●	83934877
 <p><b>Greif- und Extraktionszange,</b> "Hechtmaul" doppelbeweglich, MTL= 20 mm <b>Grasping and extraction forceps,</b> "pike-mouth" double jaw action, JL= 20 mm</p>	8393.483	●	●	83934837

\* JL = Jaw length when jaws closed (approximate measurements)





\* MTL = Maulteillänge bei geschlossenem Maulteil (gerundete Angaben)









HF connecting cable see page BDE 163.

HF-Anschlusskabel siehe Blatt BDE 163.

**ERAGON** modular  
modular instruments 5 mm

**ERAGON** modular  
modulare Instrumente 5 mm

<p><b>ERAGON</b>axial</p> <p>Alle Innenteile und Schaffrohre sind ebenfalls mit <b>ERAGONaxial</b> kombinierbar. <i>All jaw inserts and sheaths can also be combined with <b>ERAGONaxial</b>.</i></p>	Griffvarianten / Handle type				<p>Drehradaufsatz, <b>ERAGONaxial Knob attachment, ERAGONaxial</b></p>  <p>autoklavierbar / autoclavable</p>
	 mit Sperre, drehbar with locking mechanism, rotatable	 HF / mono ohne Sperre, drehbar without locking mechanism, rotatable	 HF / mono mit Sperre, drehbar with locking mechanism, rotatable	 mit Sperre, nicht drehbar with locking mechanism, not rotatable	
Typen / Types	83930082	83930083	83930084	83930085	8988

<p>Innenteil <i>Jaw insert</i></p>  <p>MTL / JL*</p>	Schaffrohr, isoliert <i>Sheath tube, insulated</i>		Griffvarianten / Handle type		<p><b>Komplett-Instrument</b></p> <ul style="list-style-type: none"> <li>• Innenteil</li> <li>• Schaffrohr</li> <li>• Handgriff</li> </ul> <p><b>Complete instrument</b></p> <ul style="list-style-type: none"> <li>• Jaw insert</li> <li>• Sheath</li> <li>• Handle</li> </ul>
	 NL / WL 330 mm	 NL / WL 450 mm	 mit Sperre, drehbar with locking mechanism, rotatable	 mit Sperre, drehbar with locking mechanism, rotatable	
Typen / Types	8393933	8394933	83930072	83930074	Typen / Types
 <b>Greif- und Extraktionszange,</b> Myomfazzzange, 2/3-kralilig, einfach beweglich, MTL= 29 mm <b>Grasping and extraction forceps, myoma grasping forceps, 2/3-claw, single jaw action, JL= 29 mm</b>	8393.488	●		●	83934887
 <b>Greifzange</b> mit zwei Zähnen, gewellte Greiffläche, doppelbe- weglich, MTL= 26 mm <b>Grasping forceps</b> with two teeth, wavy grasping surface atraumatic, double jaw action, JL= 26 mm	8393.490	●		●	83934907
 <b>Krallengreifzange,</b> doppelbeweglich, MTL= 27 mm <b>Claw grasping forceps,</b> double jaw action, JL= 27 mm	8393.494	●		●	83934945

\* JL = Jaw length when jaws closed (approximate measurements)





\* MTL = Maulteillänge bei geschlossenem Maulteil (gerundete Angaben)





**ERAGON** modular

modular instruments 5 mm

**ERAGON** modular

modulare Instrumente 5 mm

<p><b>ERAGON</b> axial</p> <p>Alle Innenteile und Schaffrohre sind ebenfalls mit <b>ERAGONaxial</b> kombinierbar. All jaw inserts and sheaths can also be combined with <b>ERAGONaxial</b>.</p>	Griffvarianten / Handle type				<p>Drehradaufsatz, <b>ERAGONaxial</b> Knob attachment, <b>ERAGONaxial</b></p>  <p>autoklavierbar / autoclavable</p>
	 <p>mit Sperre, drehbar with locking mechanism, rotatable</p>	 <p>HF / mono ohne Sperre, drehbar without locking mechanism, rotatable</p>	 <p>HF / mono mit Sperre, drehbar with locking mechanism, rotatable</p>	 <p>mit Sperre, nicht drehbar with locking mechanism, not rotatable</p>	
Typen / Types	83930082	83930083	83930084	83930085	8988

<p>Innenteil Jaw insert</p>  <p>MTL / JL*</p>	Schaffrohr, isoliert Sheath tube, insulated		Griffvarianten / Handle type		<p><b>Komplett-Instrument</b></p> <ul style="list-style-type: none"> <li>• Innenteil</li> <li>• Schaffrohr</li> <li>• Handgriff</li> </ul> <p><b>Complete instrument</b></p> <ul style="list-style-type: none"> <li>• Jaw insert</li> <li>• Sheath</li> <li>• Handle</li> </ul>
	NL / WL 330 mm	NL / WL 450 mm	HF / mono	ohne Sperre, drehbar without locking mechanism, rotatable	
Typen / Types	8393933	8394933	83930073		Typen / Types
 <p><b>Greif- und Koagulationszange</b>, distale Querverzahnung mit Maulkehle, doppelbeweglich, MTL= 15 mm <b>Grasping and coagulating forceps</b>, distal cross-cut toothing with jaw throat, double jaw action, JL= 15 mm</p>	8393.287	●		●	<b>83932877</b>
 <p><b>Probe-Exzisionszange</b>, mit Dornen, doppelbeweglich MTL= 13 mm <b>Biopsy forceps</b>, with pins, double jaw action JL= 13 mm</p>	8393.091	●		●	<b>83930917</b>
	8394.091		●	●	<b>83940917</b>
 <p><b>Probe-Exzisionszange</b>, durchschneidend, einfach beweglich, MTL= 14 mm <b>Biopsy forceps</b>, severing, single jaw action JL= 14 mm</p>	8393.092	●		●	<b>83930927</b>
	8394.092		●	●	<b>83940927</b>

\* JL = Jaw length when jaws closed (approximate measurements)





\* MTL = Maulteillänge bei geschlossenem Maulteil (gerundete Angaben)





HF connecting cable see page BDE 163.

HF-Anschlusskabel siehe Blatt BDE 163.

**ERAGON** modular  
modular instruments 5 mm

**ERAGON** modular  
modulare Instrumente 5 mm

<p><b>ERAGON</b> axial</p> <p>Alle Innenteile und Schaffrohre sind ebenfalls mit <b>ERAGONaxial</b> kombinierbar. <i>All jaw inserts and sheaths can also be combined with <b>ERAGONaxial</b>.</i></p>	Griffvarianten / Handle type				<p>Drehradaufsatz, <b>ERAGONaxial</b> <i>Knob attachment, <b>ERAGONaxial</b></i></p>  <p>autoklavierbar / autoclavable</p>
	 <p>mit Sperre, drehbar <i>with locking mechanism, rotatable</i></p>	 <p>HF / mono ohne Sperre, drehbar <i>without locking mechanism, rotatable</i></p>	 <p>HF / mono mit Sperre, drehbar <i>with locking mechanism, rotatable</i></p>	 <p>mit Sperre, nicht drehbar <i>with locking mechanism, not rotatable</i></p>	
Typen / Types	83930082	83930083	83930084	83930085	8988



<p>Innenteil <i>Jaw insert</i></p>  <p>MTL / JL*</p>	<p>Schaffrohr, isoliert <i>Sheath tube, insulated</i></p>  <p>NL / WL 330 mm</p>	<p>Griffvarianten / Handle type</p>  <p>HF / mono</p>	<p><b>Komplett-Instrument</b></p> <ul style="list-style-type: none"> <li>• Innenteil</li> <li>• Schaffrohr</li> <li>• Handgriff</li> </ul> <p><b>Complete instrument</b></p> <ul style="list-style-type: none"> <li>• <i>Jaw insert</i></li> <li>• <i>Sheath</i></li> <li>• <i>Handle</i></li> </ul>	
		<p>ohne Sperre, drehbar <i>without locking mechanism, rotatable</i></p>		
Typen / Types	8393933	83930073	Typen / Types	
 <p><b>Probe-Exzisionszange,</b> spitze Löffelzange, einfach beweglich, MTL= 20 mm <b>Biopsy forceps,</b> <i>pointed spoon forceps,</i> <i>single jaw action,</i> <i>JL= 20 mm</i></p>	8393.093	●	●	<b>83930937</b>

\* JL = Jaw length when jaws closed (approximate measurements)

\* MTL = Maulteillänge bei geschlossenem Maulteil (gerundete Angaben)



Grasping Forceps 5 mm

Greifzangen 5 mm

<i>with spring handle and cleaning channel</i>		<i>mit Federgriff und Spülanschluss</i>	
			
		NL / WL 320 mm	Typen / Types
		●	<b>8383.141</b>
<b>Greifzange monopolar, flach</b> <i>Grasping forceps monopolar, flat</i>			

HF connecting cable see page BDE 163.



HF-Anschlusskabel siehe Blatt BDE 163.

<i>with spring handle and cleaning channel</i>		<i>mit Federgriff und Spülanschluss</i>	
			
		NL / WL 310 mm	Type / Type
		●	<b>8383.41</b>
<b>Greifzange mit gerieften Greifplättchen</b> <i>Grasping forceps with grooved plates</i>			

*Cholangiography Catheter  
Grasping Forceps 5 mm*

*Cholangiografie-Katheter-  
Greifzange 5 mm*

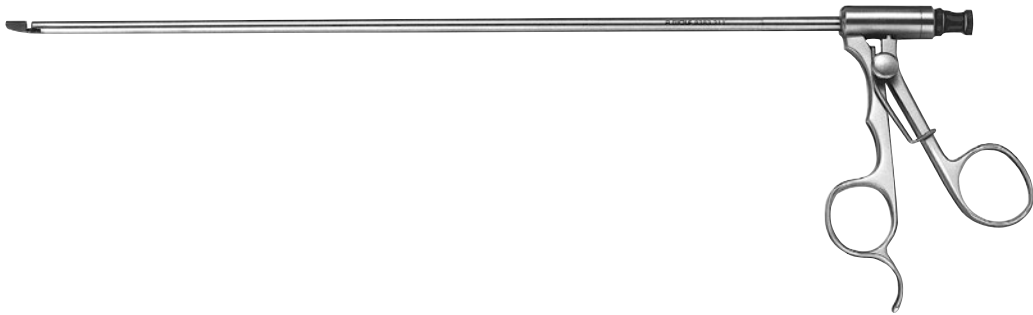
4

		
	NL / WL 295 mm	Type / Type
 <b>Greifzange</b> für Cholangiografie-Katheter <b>Grasping forceps</b> <i>for cholangiography catheter</i>	●	<b>8383.311</b>



*For introducing a cholangiography catheter to 7 Fr. into the cystic duct.*





Zum Einbringen eines Cholangiografie-Katheters bis 7 Charr. in den Ductus cysticus.

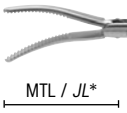

**ERAGON** modular  
modular Instruments 10 mm

**ERAGON** modular  
modulare Instrumente 10 mm

<p><b>ERAGON</b> axial</p> <p>Alle Innenteile und Schaftröhre sind ebenfalls mit <b>ERAGONaxial</b> kombinierbar. <i>All jaw inserts and sheaths can also be combined with ERAGONaxial.</i></p>	Griffvarianten / Handle type		<p>Drehradaufsatz, ERAGONaxial Knob attachment, ERAGONaxial</p>  <p>autoklavierbar / autoclavable</p>
	 <p>mit Sperre, drehbar with locking mechanism, rotatable</p>	 <p>mit Sperre, nicht drehbar with locking mechanism, not rotatable</p>	
Typen / Types	83930082	83930085	8988





Innenteil / Jaw insert	Schaftröhre, unisoliert Sheath tube, uninsulated		Griffvarianten / Handle type		<p><b>Komplett-Instrument</b></p> <ul style="list-style-type: none"> <li>• Innenteil</li> <li>• Schaftröhre</li> <li>• Handgriff</li> </ul> <p><b>Complete instrument</b></p> <ul style="list-style-type: none"> <li>• Jaw insert</li> <li>• Sheath tube</li> <li>• Handle</li> </ul>
	Typen / Types	NL / WL 330 mm	NL / WL 450 mm	mit Sperre, ohne HF-Anschluss with locking mechanism, without RF connector	
 <p>MTL / JL*</p>	8395902	8396902	83930072		
 <p>Greif- / Dissektionszange "Maryland", doppelbeweglich MTL= 36 mm <i>Grasping and dissecting forceps, "Maryland", double jaw action, JL= 36mm</i></p>	8395.225	●		●	83952257
	8396225		●	●	83962257
 <p>Dissektionszange, rechtwinkelig gebogen, doppelbeweglich, MTL= 35 mm <i>Dissecting forceps, right angled, both jaw action, JL= 35 mm</i></p>	8395.226	●		●	83952268
	8396226		●	●	83962267
 <p>Atraumatische Greifzange "Babcock", große distale Greiffläche mit feiner Querverzahnung, doppelbeweglich, MTL= 42 mm <i>Atraumatic grasping forceps, "Babcock", large distal grasping surface with fine horizontal serration, double jaw action, JL= 42 mm</i></p>	8395.187	●		●	83951877
	8396187		●	●	83961877
 <p>Atraumatische Greifzange, "Babcock", doppelbeweglich MTL= 38 mm <i>Atraumatic grasping forceps, "Babcock", double jaw action JL= 38 mm</i></p>	8395.214	●		●	83952148

\* JL = Jaw length when jaws closed (approximate measurements)







\* MTL = Maulteillänge bei geschlossenem Maulteil (gerundete Angaben)

**ERAGON** modular  
modular Instruments 10 mm

**ERAGON** modular  
modulare Instrumente 10 mm

 Alle Innenteile und Schaffrohre sind ebenfalls mit <b>ERAGONaxial</b> kombinierbar. <i>All jaw inserts and sheaths can also be combined with <b>ERAGONaxial</b>.</i>	Griffvarianten / Handle type		Drehradaufsatz, <b>ERAGONaxial</b> <i>Knob attachment, <b>ERAGONaxial</b></i>  autoklavierbar / autoclavable
	 mit Sperre, drehbar <i>with locking mechanism, rotatable</i>	 mit Sperre, nicht drehbar <i>with locking mechanism, not rotatable</i>	
Typen / Types	83930082	83930085	8988

4



Innenteil / <i>Jaw insert</i>  MTL / JL*	Schaffrohr, unisoliert <i>Sheath tube, uninsulated</i>		Griffvarianten / <i>Handle type</i>  mit Sperre, ohne HF-Anschluss <i>with locking mechanism, without HF connector</i>		Komplett-Instrument • Innenteil • Schaffrohr • Handgriff Complete instrument • <i>Jaw insert</i> • <i>Sheath tube</i> • <i>Handle</i>
	Typen / Types	NL / WL 330 mm	NL / WL 450 mm	83930072	Typen / Types
 <b>Tellerfazzange</b> , doppelbeweglich, MTL= 50 mm <i>Plate-shaped grasping forceps, double jaw action, JL= 50 mm</i>	8395.234	●		●	<b>83952347</b>
	8396234		●	●	<b>83962347</b>
 <b>Greifzange mit Hechtmaul</b> , doppelbeweglich, MTL= 20 mm <i>Grasping forceps with alligator jaws, double jaw action, JL= 20 mm</i>	8395.236	●		●	<b>83952368</b>
	8396236		●	●	<b>83962367</b>
 <b>Greifzange</b> , 2/3 krallig, MTL= 49 mm <i>Grasping forceps, 2/3 claws, JL= 49 mm</i>	8395.204	●		●	<b>83952048</b>
	8396204		●	●	<b>83962047</b>
 <b>Krallengreifzange</b> , mit zusätzlicher Zahnreihe, doppelbeweglich, MTL= 38 mm <i>Claw-type grasping forceps, with an additional row of teeth, double jaw action, JL= 38 mm</i>	8395490	●		●	<b>83954907</b>





\* JL = Jaw length when jaws closed (approximate measurements)

\* MTL = Maulteillänge bei geschlossenem Maulteil (gerundete Angaben)

**ERAGON** modular  
modular instruments 10 mm

**ERAGON** modular  
modulare Instrumente 10 mm

<p><b>ERAGON</b> axial</p> <p>Alle Innenteile und Schaftrohre sind ebenfalls mit <b>ERAGONaxial</b> kombinierbar. All jaw inserts and sheaths can also be combined with <b>ERAGONaxial</b>.</p>	Griffvarianten / Handle type		<p>Drehradaufsatz, ERAGONaxial Knob attachment, ERAGONaxial</p>  <p>autoklavierbar / autoclavable</p>
	 <p>mit Sperre, drehbar with locking mechanism, rotatable</p>	 <p>mit Sperre, nicht drehbar with locking mechanism, not rotatable</p>	
Typen / Types	83930082	83930085	8988

<p>Innenteil / Jaw insert</p> 	<p>Schaftrohr, unisoliert Sheath tube, uninsulated</p>  <p>NL / WL 330 mm</p>	<p>Griffvarianten / Handle type</p>  <p>mit Sperre, ohne HF-Anschluss with locking mechanism, without RF connector</p>	<p><b>Komplett-Instrument</b></p> <ul style="list-style-type: none"> <li>• Innenteil</li> <li>• Schaftrohr</li> <li>• Handgriff</li> </ul> <p><b>Complete instrument</b></p> <ul style="list-style-type: none"> <li>• Jaw insert</li> <li>• Sheath tube</li> <li>• Handle</li> </ul>	
		Typen / Types		8395902
 <p><b>Krallengreifzange, doppelbeweglich, MTL = 38 mm</b> <b>Claw grasping forceps, double jaw action, JL = 38 mm</b></p>	8395.489	●	●	<b>83954897</b>
 <p><b>Löffelzange, MTL = 31 mm</b> <b>Spoon forceps, JL = 31 mm</b></p>	8395.244	●	●	<b>83952448</b>

\* JL = Jaw length when jaws closed (approximate measurements)



\* MTL = Maulteillänge bei geschlossenem Maulteil (gerundete Angaben)



**ERAGON** modular  
micro

modular scissors 2 mm

**ERAGON** modular  
micro

modulare Schere 2 mm

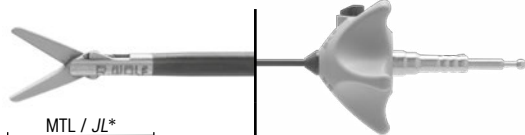
<p>Alle Innenteile und Schaffrohre sind ebenfalls mit <b>ERAGONaxial</b> kombinierbar. <i>All jaw inserts and sheaths can also be combined with <b>ERAGONaxial</b>.</i></p>	<p>Griffvarianten / Handle type</p>  <p>ohne Sperre, drehbar <i>without locking mechanism, rotatable</i></p>	<p>Drehradaufsatz, <b>ERAGONaxial</b> <i>Knob attachment,</i> <b>ERAGONaxial</b></p>  <p>autoklavierbar / <i>autoclavable</i></p>
	<p>Type / Type</p>	<p>83930083</p>

<p>Innenteil mit isoliertem Schaffrohr <i>Jaw insert with insulated sheath tube</i></p>  <p>MTL / JL*</p>	<p>Griffvarianten / Handle type</p>  <p>HF / mono</p> <p>ohne Sperre, drehbar <i>without locking mechanism, rotatable</i></p>	<p><b>Komplett-Instrument</b> • Innenteil mit Schaffrohr • Handgriff <b>Complete instrument</b> • Jaw insert with sheath tube • Handle</p>		
			<p>NL / WL 240 mm</p>	<p>Type / Type</p>
 <p><b>Schere,</b> gerade, doppelbeweglich, MTL= 7 mm <b>Scissors,</b> straight, double jaw action JL= 7 mm</p>	<p>8388200</p>	<p>●</p>	<p>●</p>	<p><b>83882007</b></p>

\* JL = Jaw length when jaws closed (approximate measurements)



\* MTL = Maulteillänge bei geschlossenem Maulteil (gerundete Angaben)







**ERAGON** modular  
*mini*

modular scissors 3.5 mm

**ERAGON** modular  
*mini*

modulare Scheren 3,5 mm

<p><b>ERAGON</b> axial</p> <p>Alle Innenteile und Schaftrohre sind ebenfalls mit <b>ERAGONaxial</b> kombinierbar. <i>All jaw inserts and sheaths can also be combined with ERAGONaxial.</i></p>	<p>Griffvarianten / Handle type</p> <p>HF / mono </p> <p>ohne Sperre, drehbar <i>without locking mechanism, rotatable</i></p>		<p>Drehradaufsatz, <b>ERAGONaxial</b> <i>Knob attachment, ERAGONaxial</i></p>  <p>autoklavierbar / <i>autoclavable</i></p>
	Typen / Types	83930083	8988

<p>Innenteil <i>Jaw insert</i></p>  <p>MTL / JL*</p>	<p>Schaftrohr, isoliert <i>Sheath tube, insulated</i></p> 		<p>Griffvarianten / Handle type</p> <p>HF / mono </p> <p>ohne Sperre, drehbar <i>without locking mechanism, rotatable</i></p>		<p><b>Komplett-Instrument</b></p> <ul style="list-style-type: none"> <li>• Innenteil</li> <li>• Schaftrohr</li> <li>• Handgriff</li> </ul> <p><b>Complete instrument</b></p> <ul style="list-style-type: none"> <li>• Jaw insert</li> <li>• Sheath</li> <li>• Handle</li> </ul>
	Typen / Types	NL / WL 240 mm	NL / WL 330 mm	83930073	
 <p>Schere "Metzenbaum", doppelbeweglich, MTL= 16 mm <b>Scissors "Metzenbaum",</b> <i>double jaw action,</i> JL= 16 mm</p>	8390215	●		●	<b>83902157</b>
	8391215			●	<b>83912157</b>
 <p>Schere "Metzenbaum", fein gezahnt, gebogen, doppelbeweglich, MTL= 14 mm <b>Scissors „Metzenbaum”,</b> <i>fine serrated, curved,</i> <i>double jaw action,</i> JL= 14 mm</p>	8390224	●		●	<b>83902247</b>
	8391224			●	<b>83912247</b>
 <p>Hakenschere, einfach beweglich, MTL= 8 mm <b>Hook scissors,</b> <i>single jaw action,</i> JL= 8 mm</p>	8390227	●		●	<b>83902277</b>
	8391227			●	<b>83912277</b>

\* JL = Jaw length when jaws closed (approximate measurements)

\* MTL = Maulteillänge bei geschlossenem Maulteil (gerundete Angaben)

HF connecting cable see page BDE 163.



HF-Anschlusskabel siehe Blatt BDE 163.







**ERAGON** modular

modular scissors 5 mm

**ERAGON** modular

modulare Scheren 5 mm

<p><b>ERAGON</b> axial</p> <p>Alle Innenteile und Schaftrohre sind ebenfalls mit <b>ERAGONaxial</b> kombinierbar. <i>All jaw inserts and sheaths can also be combined with <b>ERAGONaxial</b>.</i></p>	<p>Griffvarianten / Handle type</p>  <p>HF / mono</p> <p>ohne Sperre, drehbar <i>without locking mechanism, rotatable</i></p>		<p>Drehradaufsatz, <b>ERAGONaxial</b> <i>Knob attachment,</i> <b>ERAGONaxial</b></p>  <p>autoklavierbar / <i>autoclavable</i></p>
	Typen / Types	83930083	8988

<p>Innenteil <i>Jaw insert</i></p>  <p>MTL / JL*</p>	<p>Schaftrohr, isoliert <i>Sheath tube, insulated</i></p> 		<p>Griffvarianten / Handle type</p>  <p>HF / mono</p> <p>ohne Sperre, drehbar <i>without locking mechanism, rotatable</i></p>		<p><b>Komplett-Instrument</b></p> <ul style="list-style-type: none"> <li>• Innenteil</li> <li>• Schaftrohr</li> <li>• Handgriff</li> </ul> <p><b>Complete instrument</b></p> <ul style="list-style-type: none"> <li>• Jaw insert</li> <li>• Sheath</li> <li>• Handle</li> </ul>
	Typen / Types	NL / WL 330 mm	NL / WL 450 mm	83930073	
 <p>Schere "Metzenbaum", links gebogen, doppelbeweglich, MTL= 23 mm <i>Scissors "Metzenbaum", curved left, double jaw action, JL= 23 mm</i></p>	8393.041	●		●	<b>83930417</b>
	8394.041		●	●	<b>83940417</b>
 <p>Schere "Metzenbaum", gebogen, doppelbeweglich, MTL= 21 mm <i>Scissors "Metzenbaum", curved, double jaw action, JL= 21.2 mm</i></p>	8393243	●		●	<b>83932437</b>
	8394243		●	●	<b>83942437</b>
 <p>Mikro-Schere "Metzenbaum", gebogen, doppelbeweglich, MTL= 18 mm <i>Micro-scissors "Metzenbaum", curved, double jaw action, JL= 18 mm</i></p>	8393.044	●		●	<b>83930447</b>

\* JL = Jaw length when jaws closed (approximate measurements)



\* MTL = Maulteillänge bei geschlossenem Maulteil (gerundete Angaben)







**ERAGON** modular

modular scissors 5 mm

**ERAGON** modular

modulare Scheren 5 mm

<p><b>ERAGON</b> axial</p> <p>Alle Innenteile und Schaftrohre sind ebenfalls mit <b>ERAGONaxial</b> kombinierbar. <i>All jaw inserts and sheaths can also be combined with ERAGONaxial.</i></p>	<p>Griffvarianten / Handle type</p>  <p>HF / mono</p> <p>ohne Sperre, drehbar <i>without locking mechanism, rotatable</i></p>		<p>Drehradaufsatz, <b>ERAGONaxial</b> <i>Knob attachment, ERAGONaxial</i></p>  <p>autoklavierbar / <i>autoclavable</i></p>
	Typen / Types	83930083	8988

<p>Innenteil <i>Jaw insert</i></p>  <p>MTL / JL*</p>	<p>Schaftrohr, isoliert <i>Sheath tube, insulated</i></p> 		<p>Griffvarianten / Handle type</p>  <p>HF / mono</p> <p>ohne Sperre, drehbar <i>without locking mechanism, rotatable</i></p>		<p><b>Komplett-Instrument</b></p> <ul style="list-style-type: none"> <li>• Innenteil</li> <li>• Schaftrohr</li> <li>• Handgriff</li> </ul> <p><b>Complete instrument</b></p> <ul style="list-style-type: none"> <li>• Jaw insert</li> <li>• Sheath</li> <li>• Handle</li> </ul>
	Typen / Types	NL / WL 330 mm	NL / WL 450 mm	83930073	
 <p><b>Schere,</b> schlank, gerade, doppelbeweglich, MTL= 20 mm <b>Scissors,</b> <i>slimline, straight,</i> <i>double jaw action,</i> <i>JL= 20 mm</i></p>	8393.045	●		●	<b>83930457</b>
 <p><b>Schere,</b> fein gezahnt, gebogen, doppelbeweglich, MTL= 26 mm <b>Scissors,</b> <i>fine-toothed, curved,</i> <i>double jaw action,</i> <i>JL= 26 mm</i></p>	8393246	●		●	<b>83932467</b>
	8394246		●	●	<b>83942467</b>
 <p><b>Schere,</b> fein gezahnt, feine Spitze, doppelbeweglich, MTL= 22 mm <b>Scissors,</b> <i>fine-toothed, fine tip,</i> <i>double jaw action,</i> <i>JL= 22 mm</i></p>	8393248	●		●	<b>83932487</b>
	8394248		●	●	<b>83942487</b>

\* JL = Jaw length when jaws closed (approximate measurements)



\* MTL = Maulteillänge bei geschlossenem Maulteil (gerundete Angaben)





HF connecting cable see page BDE 163.

HF-Anschlusskabel siehe Blatt BDE 163.

**ERAGON** modular  
modular scissors 5 mm

**ERAGON** modular  
modulare Schere 5 mm

<p><b>ERAGON</b> axial</p> <p>Alle Innenteile und Schaftrohre sind ebenfalls mit <b>ERAGONaxial</b> kombinierbar. <i>All jaw inserts and sheaths can also be combined with <b>ERAGONaxial</b>.</i></p>	<p>Griffvarianten / Handle type</p>  <p>HF / mono</p> <p>ohne Sperre, drehbar <i>without locking mechanism, rotatable</i></p>		<p>Drehradaufsatz, <b>ERAGONaxial</b> <i>Knob attachment, ERAGONaxial</i></p>  <p>autoklavierbar / autoclavable</p>
	Typen / Types	83930083	8988

<p>Innenteil <i>Jaw insert</i></p>  <p>MTL / JL*</p>	<p>Schaftrohr, isoliert <i>Sheath tube, insulated</i></p> 		<p>Griffvarianten / Handle type</p>  <p>HF / mono</p> <p>ohne Sperre, drehbar <i>without locking mechanism, rotatable</i></p>	<p><b>Komplett-Instrument</b></p> <ul style="list-style-type: none"> <li>• Innenteil</li> <li>• Schaftrohr</li> <li>• Handgriff</li> </ul> <p><b>Complete instrument</b></p> <ul style="list-style-type: none"> <li>• Jaw insert</li> <li>• Sheath</li> <li>• Handle</li> </ul>	
	Typen / Types	NL / WL 330 mm	NL / WL 450 mm		83930073
 <p><b>Hakenschere,</b> gezähnt, einfach beweglich, MTL= 14 mm <b>Hook scissors,</b> serrated, single jaw action, JL= 14 mm</p>	8393.081	●		●	<b>83930817</b>
	8394.081		●	●	<b>83940817</b>

\* JL = Jaw length when jaws closed (approximate measurements)

\* MTL = Maulteillänge bei geschlossenem Maulteil (gerundete Angaben)





**ERAGON** *modu blades*

Modular "Metzenbaum" Scissors with single-use blades 5.5 mm

**ERAGON** *modu blades*

Modulare "Metzenbaum"-Schere mit Einmal-Aufsatz 5,5 mm

Innenteil / Jaw insert	Zugstange / Control rod						Handgriff / Handle	Komplett-Instrument • Innenteil • Schaffrohr • Handgriff
	NL / WL 260 mm		NL / WL 330 mm		NL / WL 450 mm			
 MTL / JL 18 mm*	Zugstange Control rod	Schaffrohr Sheath tube	Zugstange Control rod	Schaffrohr Sheath tube	Zugstange Control rod	Schaffrohr Sheath tube	 HF / mono	Complete instrument • Jaw insert • Sheath tube • Handle
	Typen / Types	8392934	8392935	8393934	8393935	8394934		
 <b>Scherenaufsatz „Metzenbaum“</b> Einmalartikel, VE=10 ST, einzeln steril verpackt <b>Scissors insert „Metzenbaum“</b> , single use article, PACK=10 PCS, sterile, individual packaging	4393.040	●	●				●	<b>83920407</b>
	4393.040			●	●		●	<b>83930407</b>
	4393.040					●	●	●

\* JL = Jaw length when jaws closed (approximate measurements)

\* MTL = Maulteillänge bei geschlossenem Maulteil (gerundete Angaben)

<b>ERAGON</b> <i>axial</i> Alle Maulteile und Schaffrohre sind ebenfalls mit <b>ERAGONaxial</b> kombinierbar. All jaw inserts and sheaths can also be combined with <b>ERAGONaxial</b> .	Handgriff / Handle	
	 HF / mono	Typen / Types
	ohne Sperre, drehbar without locking mechanism, rotatable	<b>83930083</b>

Optional:

**Knob attachment,**

**ERAGON axial** autoclavable ..... 8988



Optional:

**Drehradaufsatz**

**ERAGON axial**, autoklavierbar ..... 8988

**THE BEST OF BOTH WORLDS**

Our popular modular "Metzenbaum" Scissors provide an effective combination of single-use and reusable components:

These scissors offer the outstanding cutting quality of single-use scissors, but the low proportion of disposable material makes these scissors much more cost-effective than single-use scissors. Insulation extending over the joint mechanism also offers additional safety, e.g. for dissection close to organs with monopolar HF current. The reusable shaft and handle guarantees high stability and long life. They also bring about a major reduction in running costs.



HF connecting cable see page BDE 163.

**THE BEST OF BOTH WORLDS**

Unsere beliebte modulare "Metzenbaum"-Schere ist eine sinnvolle Kombination aus Einweg- und Mehrwegkomponenten:

Sie bietet die hervorragende Schneidequalität einer Einwegscheren, ist durch den geringen Einweganteil aber wesentlich ökonomischer als diese. Eine bis über die Gelenkmechanik reichende Isolation bietet dabei zusätzliche Sicherheit z.B. bei der organnahen Präparation mit monopolarer HF-Strom. Durch die wiederverwendbaren Trägerkomponenten, die höchste Stabilität und Lebensdauer garantieren, werden laufende Kosten extrem reduziert.

HF-Anschlusskabel siehe Blatt BDE 163.

**ERAGON** modular

Accessories

**ERAGON** modular

Zubehör

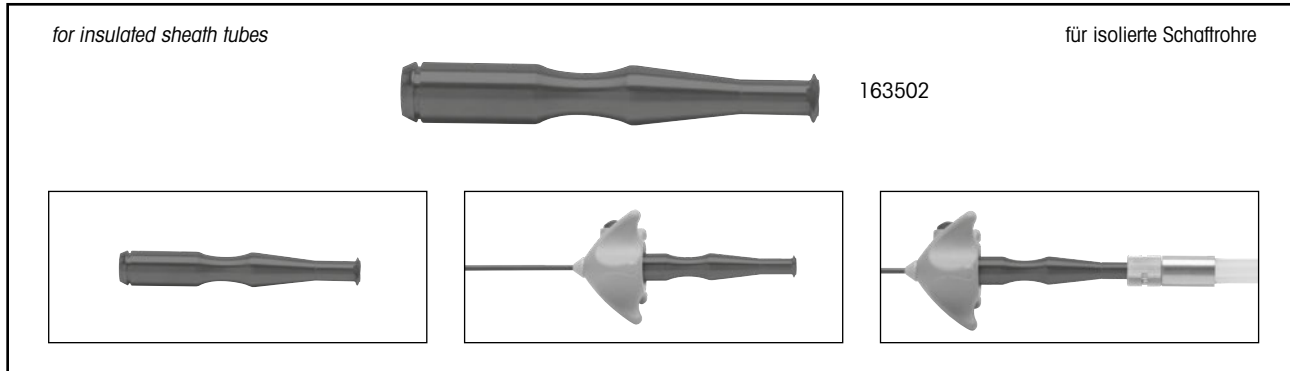

For manual and machine Reprocessing:

**Irrigation adapter,**  
Ø 9 mm, length 64 mm  
for insulated sheath tubes ..... 163502

Für manuelle und maschinelle Aufbereitung:

**Spüladapter,**  
Ø 9 mm, Länge 64 mm  
für isolierte Schaftröhre ..... 163502

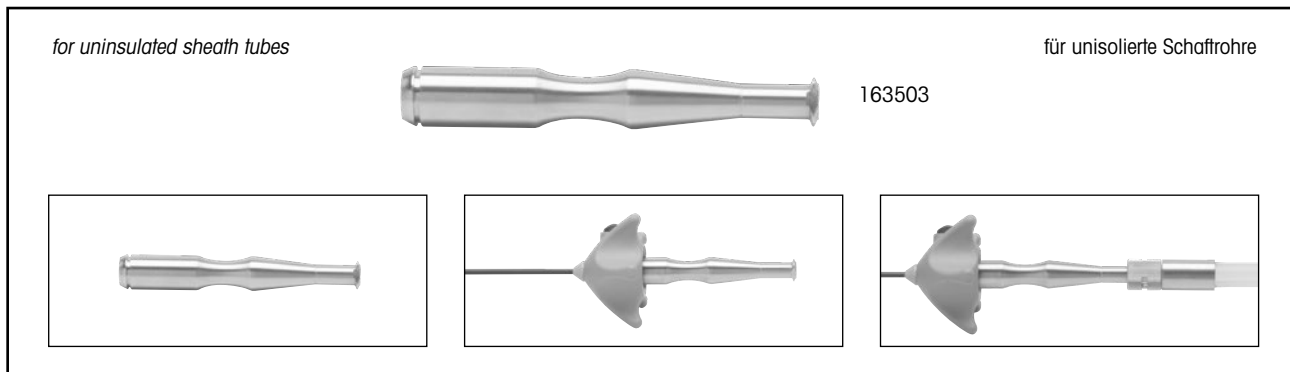

For manual and machine Reprocessing:



**Irrigation adapter,**  
Ø 9 mm, length 64 mm  
for uninsulated sheath tubes ..... 163503





Für manuelle und maschinelle Aufbereitung:

**Spüladapter,**  
Ø 9 mm, Länge 64 mm  
für unisolierte Schaftröhre ..... 163503

*Handle Type  
for modular systems*

**Griffvarianten  
für modulare Systeme**

Griffvarianten / Handle type <b>ERAGON</b> <sub>modular</sub>	drehbar mechanism, rotatable	mit Sperre with locking	ohne Sperre without locking	mit HF with HF	ohne HF without HF	Typen Types
	•	•			•	<b>83930072</b>
	•		•	•		<b>83930073</b>
	•	•		•		<b>83930074</b>

Griffvarianten / Handle type <b>ERAGON</b> <sub>axial</sub>	drehbar mechanism, rotatable	mit Sperre with locking	ohne Sperre without locking	mit HF with HF	ohne HF without HF	Typen Types
	•	•			•	<b>83930082</b>
	•		•	•		<b>83930083</b>
	•	•		•		<b>83930084</b>
		•			•	<b>83930085</b>



Optional zu 83930082 / 83930083 / 83930084:  
**Drehradaufsatz ERAGON axial**, autoklavierbar ..... 8988

Optional for 83930082 / 83930083 / 83930084:  
**Knob attachment, ERAGON axial** autoclavable ..... 8988

All **ERAGON**<sub>modular</sub> components are compatible with **ERAGON**<sub>axial</sub>

Alle **ERAGON**<sub>modular</sub> Komponenten sind mit **ERAGON**<sub>axial</sub> kompatibel.

*Handle Type*  
for modular systems

Griffvarianten  
für modulare Systeme

Griffvarianten / Handle type	nicht drehbar mechanism, not rotatable	mit Sperre with locking	mit HF with HF	ohne HF without HF	Typen Types
axial / axial 	●	●		●	<b>8393.941</b>







5

### Bipolar Forceps 3.5 mm

with spring handle  
modular system

### Bipolar-Zange 3,5 mm

mit Federgriff  
modulares System

						
Innenteil / Jaw insert  	Außenrohr / Outer tube  		Schraubkappe mit Hülse Screw-on cap with sleeve  	Federgriff Spring handle  	<b>Komplett-Instrument</b> • Innenteil • Außenrohr • Schraubkappe • Federgriff <b>Complete instrument</b> • Jaw insert • Outer tube • Screw-on cap • Spring handle	
	Typen / Types 8391.715	NL / WL 240 mm 8390.921	NL / WL 340 mm 8391.921	8393.978	8393.975	Typen / Types 8391.742
 Bipolar-Pinzette Bipolar forceps			•	•	•	

Spare parts:

Rubber cap ..... 15220.019  
Luer sealing cap ..... 15023.153

Ersatzteile:

Gummikappe ..... 15220.019  
Luer-Verschlußkappe ..... 15023.153





### Bipolar Forceps 5 mm

with spring handle  
modular system

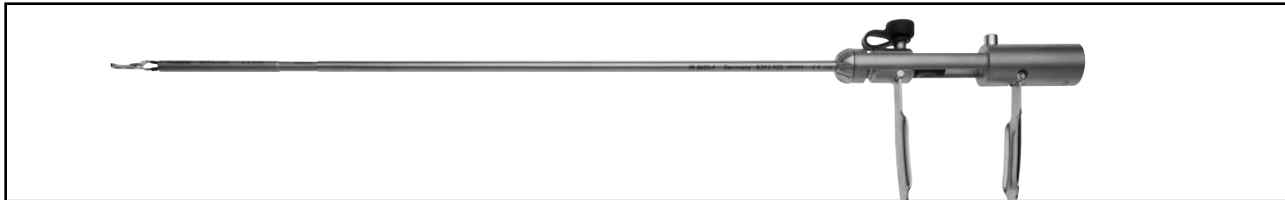
### Bipolar-Zange 5 mm

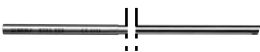
mit Federgriff  
modulares System



<p>Innenteil / <i>Jaw insert</i></p> 	<p>Schubhülse / <i>Sliding sleeve</i></p> 	<p>Außenrohr / <i>Outer tube</i></p> 	<p>Federgriff <i>Spring handle</i></p> 	<p><b>Komplett-Instrument</b></p> <ul style="list-style-type: none"> <li>• Innenteil</li> <li>• Schubhülse</li> <li>• Außenrohr</li> <li>• Federgriff</li> </ul> <p><b>Complete instrument</b></p> <ul style="list-style-type: none"> <li>• <i>Jaw insert</i></li> <li>• <i>Outer tube</i></li> <li>• <i>Screw-on cap</i></li> <li>• <i>Spring handle</i></li> </ul>	
<p>Typen / <i>Types</i></p>	<p>NL / WL 300 mm</p>	<p>NL / WL 300 mm</p>	<p>8393.923</p>	<p>8393.925</p>	<p>8393.975</p> <p>Type / <i>Type</i></p>
<p><b>Bipolar-Greifzange, Kleppinger Prinzip Bipolar grasping forceps, Kleppinger principle</b></p> 	<p>8393.714</p>	<p>•</p>	<p>•</p>	<p>•</p>	<p><b>8393.741</b></p>

6

Spare parts:

**Rubber cap** ..... 15220.019

**Luer sealing cap** ..... 15023.153

Bipolar connecting cable see page BDE 164.

Ersatzteile:

**Gummikappe** ..... 15220.019

**Luerverschlusskappe** ..... 15023.153

Bipolar-Anschlusskabel siehe Blatt BDE 164.







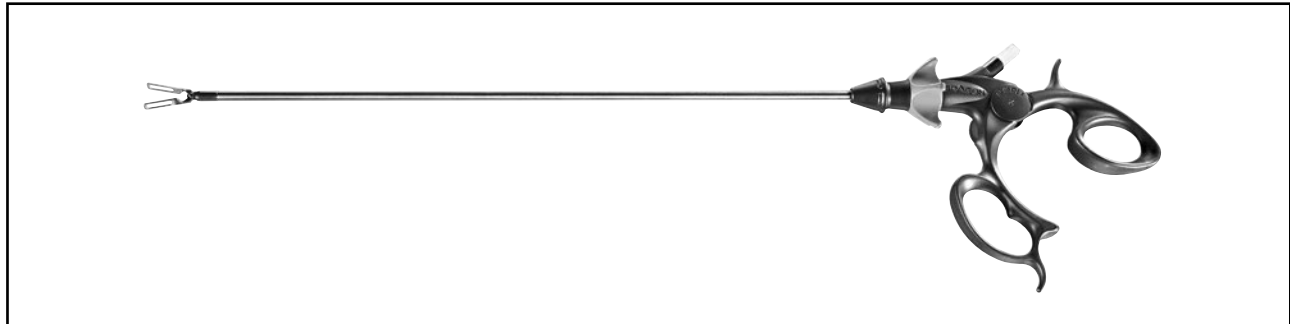

**ERAGON** bipolar

modular bipolar instruments, 5.5 mm,  
rotatable

**ERAGON** bipolar

modulare Bipolar-Instrumente, 5,5 mm,  
drehbar



Innenteil <i>Jaw insert</i>	Schaffrohr <i>Sheath tube</i>		Handgriff, drehbar <i>Handle, rotatable</i>	Komplett • Innenteil • Schaffrohr • Handgriff <i>Complete</i> • Jaw insert • Sheath • Handle	
	Typen / Types	NL / WL 330 mm			NL / WL 460 mm
 MTL / JL*					
	Typen / Types	83930921	82340024	839300102	Typen / Types
 Greif- und Präparierzange, MTL= 21 mm Grasping and preparation forceps, JL= 21 mm	83930031	•		•	839300312
	839400310		•	•	839400312
 Greif- und Dissektionszange "Maryland-Dissektor", MTL= 23 mm Grasping and dissecting forceps "Maryland-Dissector", JL= 23 mm	83930032	•		•	839300322
	839400320		•	•	839400322
 Greif- und Dissektionszange "Dolphin", MTL= 21 mm Grasping and dissecting forceps "Dolphin", JL= 21 mm	83930033	•		•	839300332
	839400330		•	•	839400332
 Fasszange, gefenestert, MTL= 23 mm Grasping forceps, fenestrated, JL= 23 mm	83930034	•		•	839300342
	839400340		•	•	839400342
 Präparierzange "Hasskamp", MTL= 19 mm Dissecting forceps "Hasskamp", JL= 19 mm	83930035	•		•	839300352
	839400350		•	•	839400352
 Sterilisationszange "Hasskamp", MTL= 19 mm Sterilisation forceps "Hasskamp", JL= 19 mm	83930036	•		•	839300362
	839400360		•	•	839400362

\* JL = Jaw length when jaws closed (approximate measurements)

\* MTL = Maulteillänge bei geschlossenem Maulteil (gerundete Angaben)





**ERAGON** bipolar

modular bipolar instruments, 5.5 mm, rotatable

**ERAGON** bipolar

modulare Bipolar-Instrumente, 5,5 mm, drehbar



<b>Innenteil</b> <b>Jaw insert</b> 	<b>Schaftrohr</b> <b>Sheath</b>  NL / WL 330 mm      NL / WL 460 mm		<b>Handgriff, drehbar</b> <b>Handle, rotatable</b> 	<b>Komplett</b> • Innenteil • Schaftrohr • Handgriff <b>Complete</b> • Jaw insert • Sheath • Handle	
	Typen / Types	83930921	82340024	839300102	Typen / Types
<b>Greif- und Dissektionszange "Münster"</b> , MTL= 22 mm <i>Grasping and dissecting forceps "Münster"</i> JL= 22 mm 	83930037	●		●	<b>839300372</b>
<b>Greif- und Dissektionszange "Maryland", kurz</b> MTL= 15 mm <i>Grasping and dissecting forceps "Maryland", short</i> , JL= 15 mm 	83930038	●		●	<b>839300382</b>
	839400380		●	●	<b>839400382</b>
	83930041	●		●	<b>839300412</b>
<b>Metzenbaumschere</b> , MTL= 22 mm <i>Metzenbaum scissors</i> , JL= 22 mm	839400410		●	●	<b>839400412</b>



\* JL = Jaw length when jaws closed (approximate measurements)

\* MTL = Maulteillänge bei geschlossenem Maulteil (gerundete Angaben)



*Electrodes 2 mm  
monopolar*

Elektroden 2 mm  
monopolar





		
	NL / WL 400 mm	Type / Type
 Koagulations-Knopf-Elektrode <i>Coagulation button electrode</i>	●	<b>823.06</b>

7

*Electrodes 3.5 mm  
monopolar*

*Elektroden 3,5 mm  
monopolar*







	NL / WL 240 mm	NL / WL 340 mm	Typen / Types
 <b>Haken-Elektrode</b> <i>Hook electrode</i>		●	<b>8379.452</b>
 <b>Hakenelektrode</b> <i>monopolar, mit distal verlängerter Isolation</i> <b>Hook electrode</b> <i>monopolar, with distal extended insulation</i>	●		<b>8785.642</b>
 <b>Nadel-Elektrode</b> <i>Needle electrode</i>		●	<b>8379.482</b>
 <b>Koagulations-Knopf-Elektrode</b> <i>Coagulation button electrode</i>		●	<b>8379.462</b>

7

*Electrodes 5 mm  
monopolar*

*Elektroden 5 mm  
monopolar*





	NL / WL 340 mm	NL / WL 420 mm	Typen / Types
	●		<b>8383.423</b>
<b>Haken-Elektrode</b> <i>Hook electrode</i>		●	<b>8384.423</b>
	●		<b>8383.426</b>
<b>Nadel-Elektrode</b> <i>Needle electrode</i>	●		<b>8383.428</b>
	●		<b>8383.429</b>
<b>Spatel-Elektrode</b> <i>Spatula electrode</i>	●		<b>8383429</b>
	●		
<b>Myom Dissektor</b> <i>Myoma dissector</i>			

7

*Button Electrodes 5 mm*  
*monopolar*



Knopf-Elektroden 5 mm  
monopolar

		
	NL / WL 450 mm	Typen / Types
 Knopf-Elektrode <i>Button electrode</i>	●	<b>8384.40</b>

7

*BipoTrode*  
*1.6 mm / 5 Fr. Bipolar Electrode*

*BipoTrode*  
*1,6 mm / 5 Charr. Bipolar-Elektrode*

		
	GL / TL 360 mm	Typen / Types
  <b>BipoTrode Bipolar-Elektrode</b> <i>BipoTrode bipolar electrode</i>	●	<b>823005</b>

7

- For precise dissection, preparation and coagulation using saline distension media, also for use in laparoscopy (e.g. in combination with trocar sleeve 8309.072 with trocar 8309.121)
- Small diameter of 5 Fr. allows use with hysteroscopes
- Made of semiflexible stainless steel so can be used with bent working channels but preferably with straight working channels of the compact R. WOLF hysteroscopes
- Robust and ergonomic handle
- Autoclavable and reusable

- Zur Dissektion, Präparation und Koagulation in der Hysteroskopie, auch in der Laparoskopie einsetzbar (passend z.B. zu Trokarhülse 8309.072 mit Trokar 8309.121)
- Sehr filigrane Abmessungen zur Anwendung durch klassische Hysteroskope mit 5 Charr. Arbeitskanal
- Durch Verwendung semielastischen Stahls sowohl durch gerade als auch durch schräg zulaufende Arbeitskanäle anwendbar
- Stabiler und ergonomischer Handgriff für einfaches Handling
- Autoklavierbar und somit wiederverwendbar

Bipolar tweezers connecting cable see page BDE 164.

Bipolar-Pinzettenanschlusskabel siehe Blatt BDE 164.

## Multifunction Suction-Irrigation System

possible combinations

## Multifunktionelles Saug-Spül-System

Kombinationsmöglichkeiten

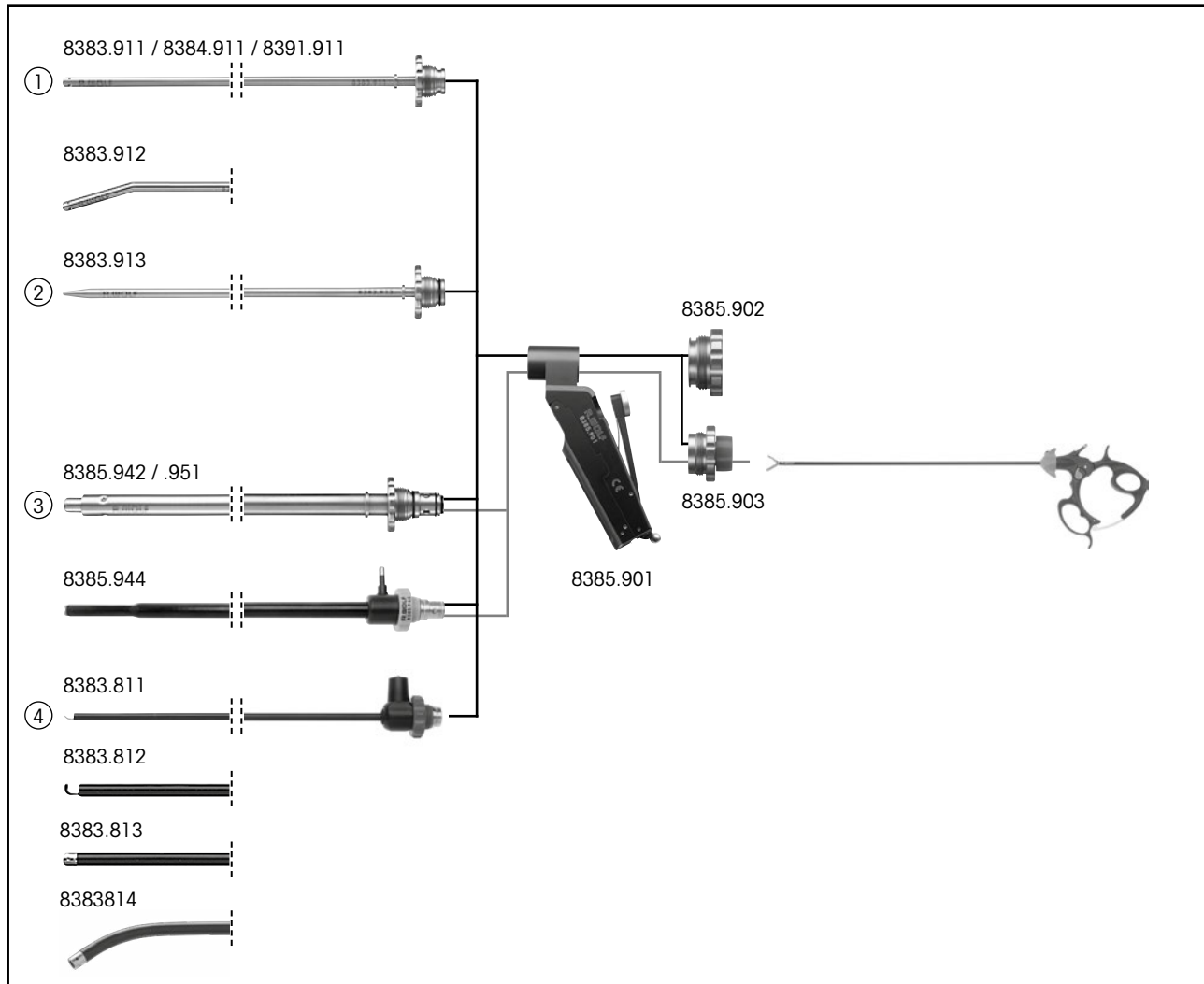

① **Suction or irrigation:**

Suction-irrigation tubes ..... 8383.911, 8384.911, 8391.911  
 Suction-irrigation tube, angled (thoracoscopy) ..... 8383.912  
 also: sealing cap ..... 8385.902

② **Blunt aquadissection:**

Pressure irrigation tube ..... 8383.913  
 also: sealing cap ..... 8385.902

③ **Suction, irrigation and use of 5 mm auxiliary instruments:**

Suction-irrigation tube ..... 8385.942 / .951  
 Suction-irrigation tube, insulated,  
 with atraumatic dissection tip ..... 8385.944  
 also: sealing adapter ..... 8385.903

④ **Tissue dissection with HF:**

HF spatula probe ..... 8383.811  
 HF hooked probe ..... 8383.812  
 HF button electrode ..... 8383.813  
 HF suction and irrigation tube, curved ..... 8383814  
 also: sealing cap ..... 8385.901

① **Saugen oder Spülen:**

Saug-Spülrohre ..... 8383.911, 8384.911, 8391.911  
 Saug-Spülrohr, gebogen (Thorakoskopie) ..... 8383.912  
 hierzu: Verschlusskappe ..... 8385.902

② **Stumpfe Aquadissektion:**

Druck-Spülrohr ..... 8383.913  
 hierzu: Verschlusskappe ..... 8385.902

③ **Saugen, Spülen und Anwendung von Hilfsinstrumenten ø 5 mm:**

Saug-Spülrohre ..... 8385.942 / .951  
 Saug-Spülrohr, isoliert,  
 mit atraumatischer Präparierspitze ..... 8385.944  
 hierzu: Dichtaufsatz ..... 8385.903

④ **Präparation von Gewebe mit HF:**

HF-Spatelsonde ..... 8383.811  
 HF-Hakensonde ..... 8383.812  
 HF-Knopfelektrode ..... 8383.813  
 HF-Saug-Spül-Rohr, gebogen ..... 8383814  
 hierzu: Verschlusskappe ..... 8385.902

## Multifunction Suction-Irrigation System

suction-irrigation handle

## Multifunktionelles Saug-Spül-System

Saug-Spül-Handgriff



- Autoclavable
- Durable
- Low long-term costs
- Universal applications
- Interfaces for various attachments
- Large lumen for efficient irrigation and suction

- Autoklavierbar
- Hoher Dauergebrauchswert
- Niedrige Langzeitkosten
- Universelle Einsetzbarkeit
- Schnittstelle für verschiedene Aufsätze
- Großes Lumen für effizientes Spülen und Saugen

**Suction-irrigation handle** ..... 8385.901

**Saug-Spül-Handgriff** ..... 8385.901

**Sealing cap** ..... 8385.902

**Verschlusskappe** ..... 8385.902

**Required to use  $\varnothing$  5 mm auxiliary instruments:**

**Notwendig bei Anwendung von Hilfsinstrumenten  $\varnothing$  5 mm:**

**Sealing attachment with opening and membrane valve** ..... 8385.903

**Dichtaufsatz mit Durchgang und Membranventil** ..... 8385.903

**Spare membrane valve** ..... 89.103

**Ersatz-Membranventil** ..... 89.103

## Suction-Irrigation Tube Sets

## Saug-Spül-Schlauchsets

### Reusable

### Mehrmalgebrauch

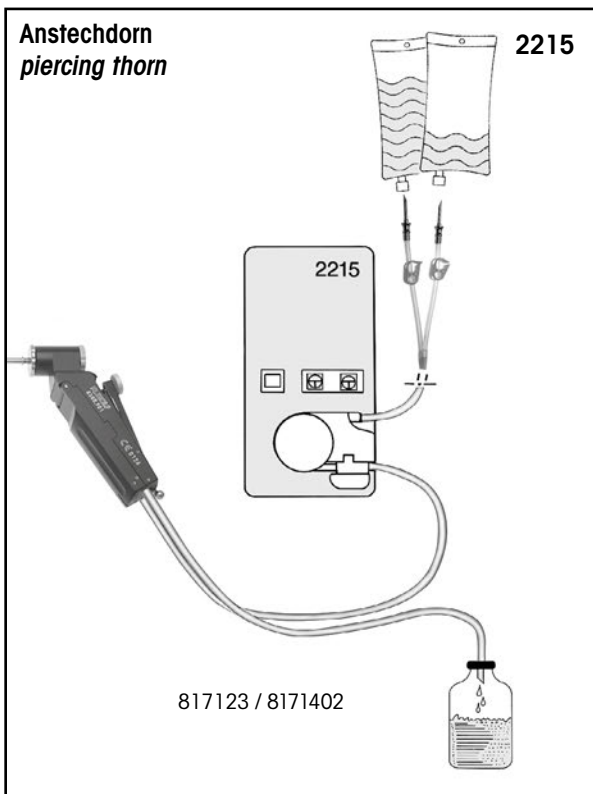

#### Schlauchansatz

mit Luer-Lock-Anschluss,  
für Saug-Spül-Handgriff 8385.901  
und Schlauchset 8171223 oder 8170.223,  
wiederverwendbar ..... 817123

#### Saugschlauch

3 m, für Saug-Spül-Handgriff 8385.901,  
wiederverwendbar ..... 8171402

#### Tube attachment

with luer-lock connector,  
for suction-irrigation handle 8385.901  
and tube set 8171223 or 8170.223,  
reusable ..... 817123

#### Suction tube

3 m, for suction-irrigation handle 8385.901,  
reusable ..... 8171402

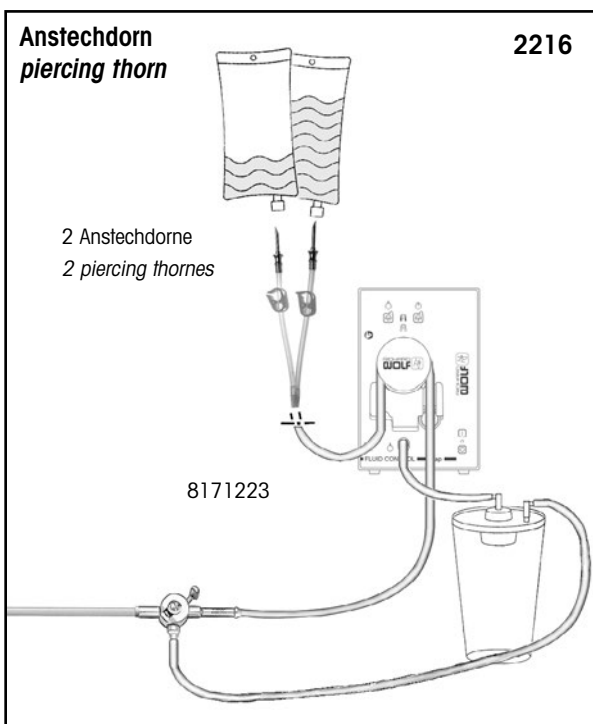

#### Schlauchset mit Anstechdorn,

mit Luer-Lock Anschluss,  
autoklavierbar, incl. 10 Ersatzmembranen, wiederverwendbar  
für 20 Aufbereitungszyklen,  
für FLUID CONTROL LAP 2216 ..... 8171223

#### Tubing set with piercing connector,

with luer-lock connector,  
autoclavable, incl. 10 replacement membranes,  
reusable for 20 reprocessing cycles,  
for FLUID CONTROL LAP 2216 ..... 8171223

#### Vakuum-Schlauch

von Pumpe zu Sekretbehälter ..... 8170.401

#### Vacuum tube

from pump to secretion trap ..... 8170.401



## Suction-Irrigation Tube Sets

## Saug-Spül-Schlauchsets

### Disposable

### Einmalgebrauch

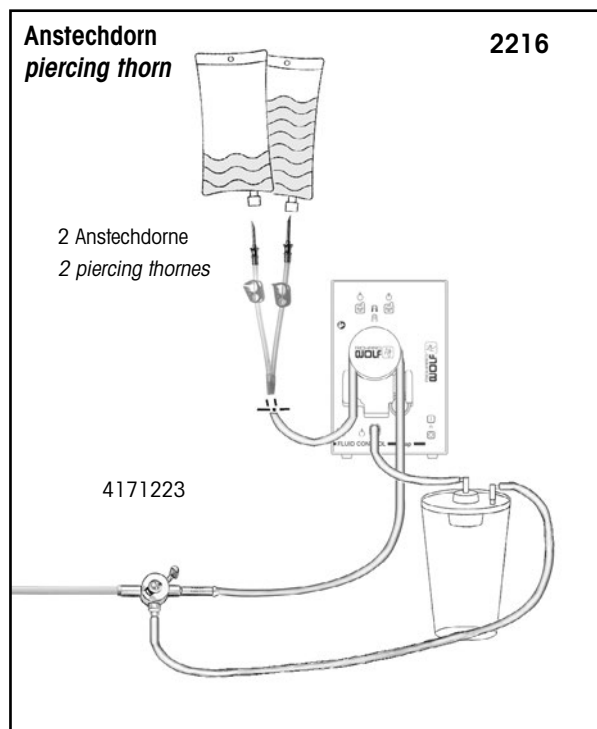

**Schlauchset mit Anstechdorn,**  
mit Luer-Lock Anschluss,  
steriler Einmalartikel, VE=10 ST,  
für FLUID CONTROL LAP 2216 ..... 4171223

**Tubing set with piercing connector,**  
with luer-lock connector,  
sterile single use item, PACK=10 PCS  
for FLUID CONTROL LAP 2216 ..... 4171223

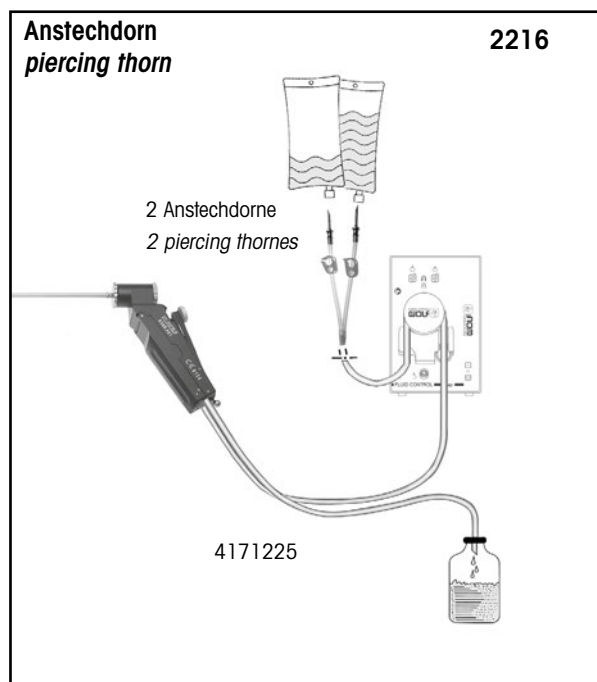

**Schlauchset mit Anstechdorn,**  
mit Anschlussstück für Saug-Spül-Handgriff (8385.901),  
inkl. Ablaufschlauch, steriler Einmalartikel, VE=10 ST,  
für FLUID CONTROL LAP 2216 ..... 4171225

**Tubing set with piercing connector,**  
with connector for suction-irrigation handle (8385.901),  
incl. drain tube, PACK=10 PCS  
for FLUID CONTROL LAP 2216 ..... 4171225

## Suction-Irrigation Tube Sets

## Saug-Spül-Schlauchsets

### Disposable

### Einmalgebrauch

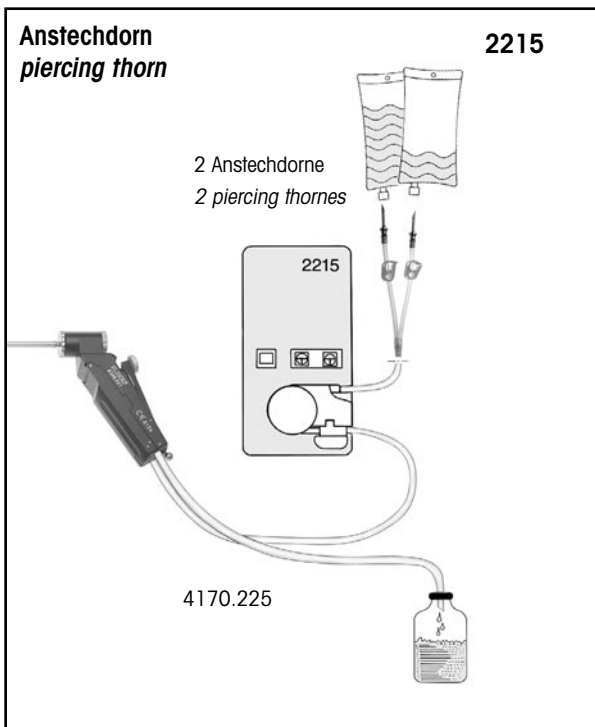

**Schlauchset**

PVC, mit 2 Anstechdornen

Einmalartikel

VE=10 ST, einzeln steril verpackt ..... 4170.225

**Tube set**

PVC, with 2 piercing thorns

disposable

PACK=10 PCS, packed singly, sterile ..... 4170.225

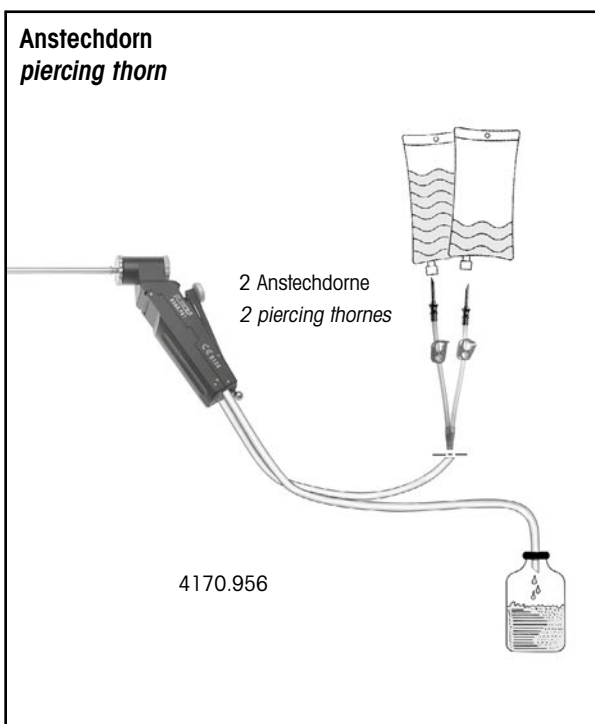

**Saug-Spül-Schlauchset,**

mit 2 Anstechdorne,

VE=10 ST, einzeln steril verpackt ..... 4170.956

**Suction-irrigation tube set,**

with 2 piercing thorns

PACK=10 PCS, packed singly, sterile ..... 4170.956

8

## Suction-Irrigation Tube Sets

## Saug-Spül-Schlauchsets

### Disposable

### Einmalgebrauch

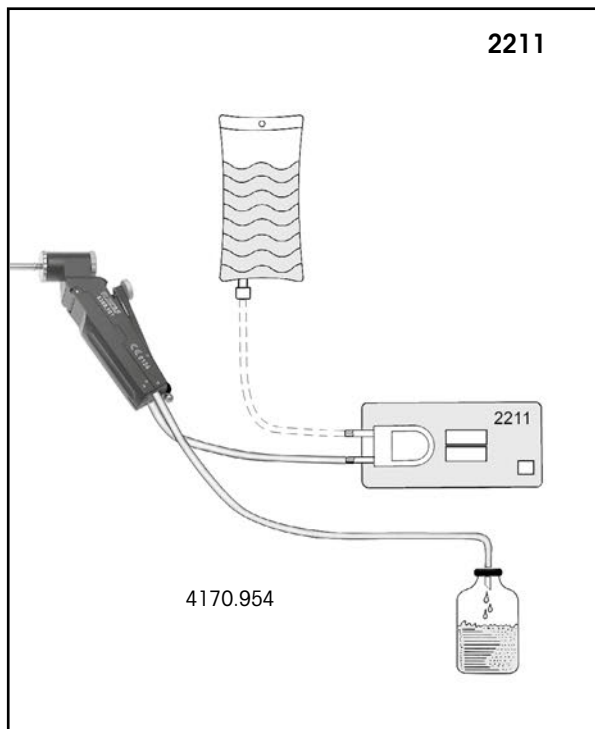

#### Saug-Spül-Schlauchset,

mit Luer-Lock,

VE=10 ST, einzeln steril verpackt ..... 4170.954

#### Suction-irrigation tube set,

with Luer-lock,

PACK=10 PCS, packed singly, sterile ..... 4170.954

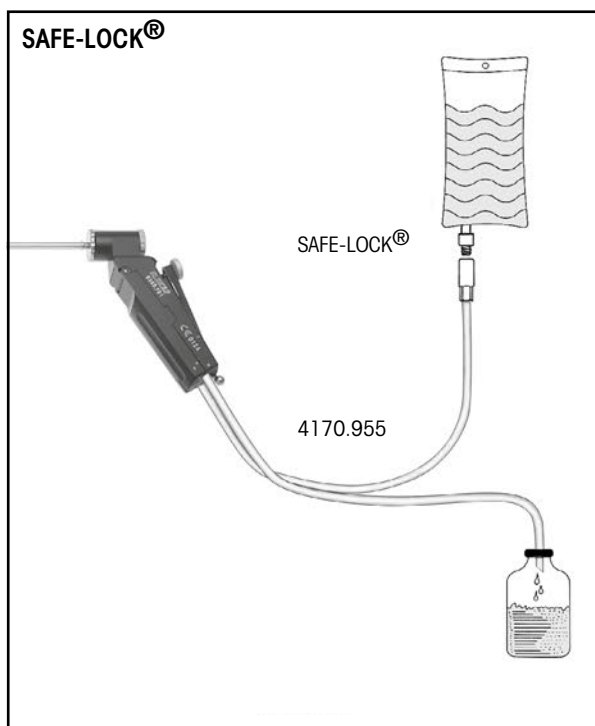

#### Saug-Spül-Schlauchset,

mit SAFE-LOCK®,

VE=10 ST, einzeln steril verpackt ..... 4170.955

#### Suction-irrigation tube set,

with safe-lock®

PACK=10 PCS, packed singly, sterile ..... 4170.955

## Suction-Irrigation Tube Sets

## Saug-Spül-Schlauchsets

### Disposable

### Einmalgebrauch

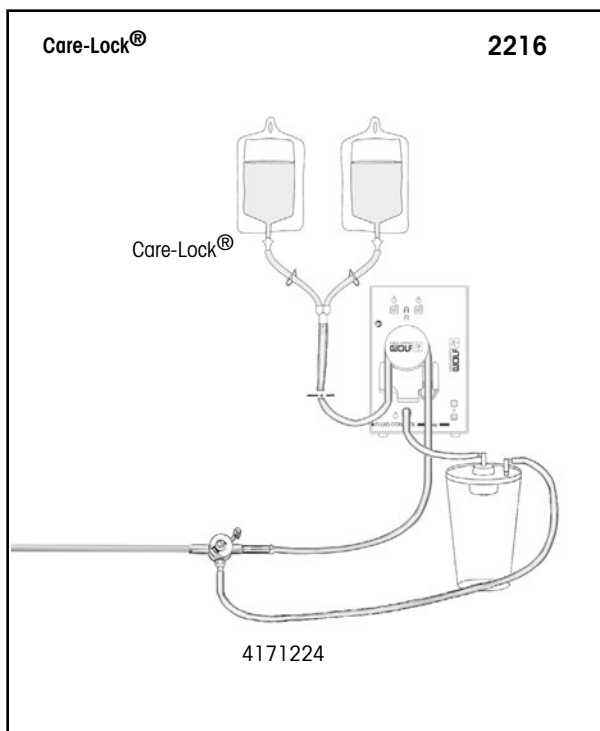





**Schlauchset mit Care-Lock®**,  
steriler Einmalartikel, VE=10 ST,  
für FLUID CONTROL LAP 2216 ..... 4171224

**Tubing set with Care-Lock®**,  
sterile single use item, PACK=10 PCS,  
for FLUID CONTROL LAP 2216 ..... 4171224



*Multifunction Suction-Irrigation System*  
Suction-irrigation tubes

Multifunktionelles Saug-Spül-System  
Saug-Spül-Rohre

	∅	NL / WL	Typen / Types
			
 Saug-Spül-Rohr Suction-irrigation tube	3.5 mm	300 mm	<b>8391.911</b>
 Saug-Spül-Rohr Suction-irrigation tube	5 mm	310 mm	<b>8383.911</b>
	5 mm	450 mm	<b>8384.911</b>
	5 mm	310 mm distal gebogen / curved distal tip	<b>8383.912</b>
 Druck-Spülrohr Irrigation tube for aquadissection	5 mm	310 mm	<b>8383.913</b>

For use of 5 mm auxiliary instruments

Zur Anwendung von 5 mm Hilfsinstrumenten







 Saug-Spül-Rohr Suction-irrigation tube	∅ 10 mm Durchlass 5 mm / capacity 5 mm	225 mm	<b>8385.942</b>
	∅ 10 mm Durchlass 5 mm / capacity 5 mm	330 mm	<b>8385.951</b>
 Saug-Spül-Rohr nach Buess, isoliert, mit atraumatischer Präparierspitze Suction-irrigation tube by Buess, insulated, with atraumatic dissection tip	∅ 10 mm Durchlass 5 mm / capacity 5 mm	330 mm	<b>8385.944</b>
notwendig zu 8385.951: Dichtaufsatz mit Durchgang und Membranventil Ersatz-Membran-Ventil (89.103)  required for 8385.951: Sealing attachment with opening and membran valve Spare membrane valve (89.103)			<b>8385.903</b>

## Multifunction Suction-Irrigation System

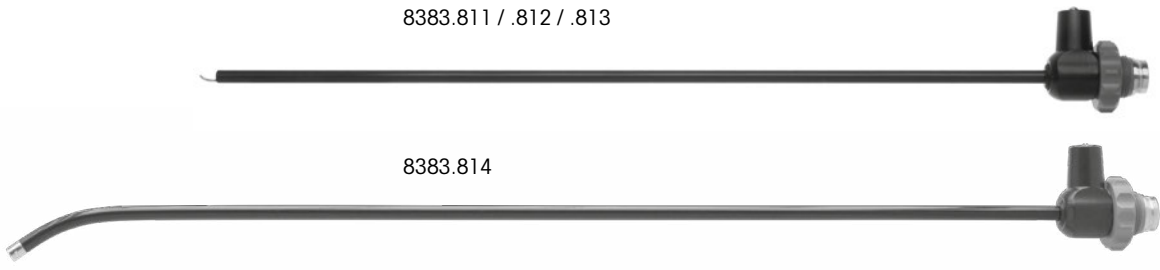
HF instruments, monopolar,  
with suction and irrigation channel

## Multifunktionelles Saug-Spül-System

HF-Instrumente, monopolar,  
mit Saug- und Spülkanal



			
	∅	NL / WL	Typen / Types
 <b>HF-Spatelsonde</b> <i>HF spatula probe</i>	5 mm	315 mm	<b>8383.811</b>
 <b>HF-Hakenelektrode</b> <i>HF hook electrode</i>			<b>8383.812</b>
 <b>HF-Knopfelektrode</b> <i>HF button electrode</i>			<b>8383.813</b>
 <b>HF-Saug-Spül-Rohr, gebogen</b> <i>HF suction and irrigation tube, curved</i>	5.4 mm	380 mm	<b>8383814</b>
alternativ zum Saug-Spül-Handgriff: <i>as an alternative to the suction-irrigation handle:</i>  <b>Saug-Spül-Ansatz</b> <i>Suction-irrigation adapter</i>	mit wartungsfreiem Zweiwegehahn, für multifunktionelles Saug-Spül-System, wiederverwendbar  <i>with maintenance-free two-way stopcock,                  for multifunctional suction-irrigation system,                  reusable</i>		 <b>8383819</b>

HF connecting cable see page BDE 163.



HF-Anschlusskabel siehe Blatt BDE 163.

*Suction-Irrigation Tubes 5 mm  
with Luer connector*

*Saug-Spülrohre 5 mm  
mit Luer-Anschluss*

		
	NL / WL 300 mm	Type / Type
 <b>Saug-Spülrohr</b> mit Luer-Anschluss Durchlass 4 mm und distalen Öffnungen <b>Suction-irrigation tube</b> with Luer connector 4 mm capacity and distal openings	●	<b>8383.51</b>

8



		
	NL / WL 330 mm	Type / Type
 <b>Saugrohr,</b> mit Luer-Anschluss, Durchlass 3 mm <b>Suction tube,</b> with Luer connector, capacity 3 mm	●	<b>8383.72</b>

### Suction Tube 5 mm

with Luer connector and one valve

### Absaugrohr 5 mm



mit Luer-Anschluss und einem Ventil

		
	NL / WL 330 mm	Typen / Types
 <p><b>Absaugrohr</b>, graduert, mit 3-mm-Luer-Anschluss <b>Suction tube</b>, graduated, with Luer connector 3 mm</p>	●	<b>8383.68</b>





Suction and Irrigation Tubes 5 mm

Saug-Spül-Rohre 5 mm

			
	NL / WL 290 mm	NL / WL 410 mm	Typen / Types
	●		<b>8583732</b>
<b>Saug-Spül-Rohr</b> mit wartungsfreiem Zweiwegehahn, Schaftrohr mit distalen Öffnungen, wiederverwendbar <b>Suction-irrigation tube</b> with maintenance-free two-way stopcock, sheath tube with distal openings, reusable		●	<b>8584732</b>

*Combination Suction and Irrigation Tube 5 mm*  
with two stop valves

Kombinations-Saug- und Spülrohr 5 mm  
mit zwei Absperrventilen

		
	NL / WL 300 mm	Type / Type
 <b>Kombinations-Saug- und Spülrohr,</b> mit Absperrventil <b>Combination suction and irrigation tube</b> with stop valves	●	<b>8383.94</b>

*Coagulation-Suction Tubes 5 mm  
monopolar*

*Koagulations-Saugrohre 5 mm  
monopolar*

with Luer connector and one valve

mit Luer-Anschluss und einem Ventil





	NL / WL 315 mm	NL / WL 450 mm	Typen / Types
	●		<b>8383.71</b>
<b>Koagulations-Saugrohr,</b> mit Luer-Anschluss, Durchlass 3 mm <b>Coagulation-suction tube,</b> with Luer connector, capacity 3 mm		●	<b>8384.71</b>

HF connecting cables see page BDE 163.

HF-Anschlusskabel siehe Blatt BDE 163.

*Tissue Retractor 5 mm*

Geweberetraktor 5 mm



		
	NL / WL 320 mm	Type / Type
 <p><b>Geweberetraktor, gerade</b> <b>Tissue retractor, straight</b></p>	●	<b>8383.691</b>

9

- |   |   |
|---|---|
| <input type="checkbox"/> <i>The extended hand of the surgeon</i>                      | <input type="checkbox"/> Verlängerte Hand des Chirurgen                                     |
| <input type="checkbox"/> <i>Held in one hand</i>                                      | <input type="checkbox"/> Einhandbedienung   |
| <input type="checkbox"/> <i>Simple manipulation of tissue and organs</i>              | <input type="checkbox"/> Problemloses Bewegen von Gewebe und Organen                        |
| <input type="checkbox"/> <i>Better view of concealed or difficult to access areas</i> | <input type="checkbox"/> Besserer Einblick in verborgene oder schlecht zugängliche Bereiche |

Clip Applicator 10 mm

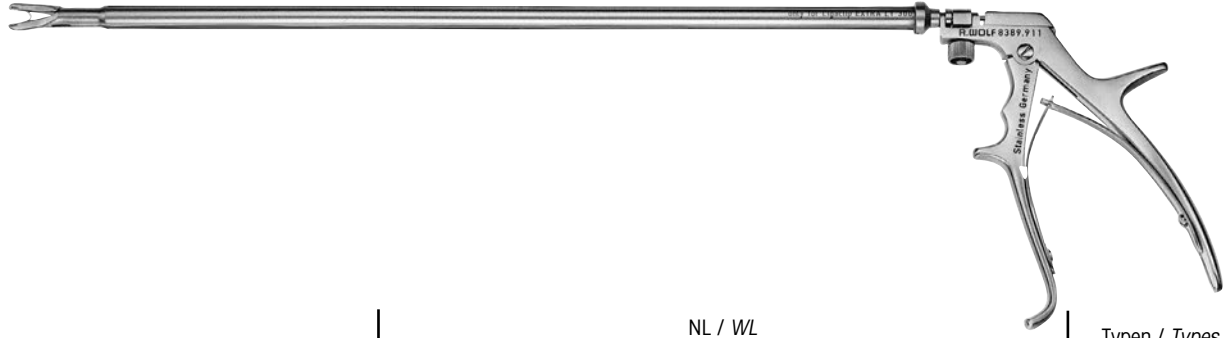
Clip-Applikator 10 mm

	<p>NL / WL 340 mm</p>	<p>Typen / Types</p>
 <p>Clip-Applikator Clip applicator</p>	<p>●</p>	<p>8389.911</p>
	<p>hierzu: <b>Einführhülse</b> mit Dichtungskappe (89.08)</p> <p>also: <b>Introducing sleeve</b> with sealing cap (89.08)</p>	<p>8389.991</p>

10

For clip ligation with Ethicon® Ligaclip® EXTRA LT 300

Zur Clipunterbindung mit Ethicon® Ligaclip® EXTRA LT 300

Ethicon® Ligaclips®, PACK=108 PCS ..... 8389.915

Ethicon® Ligaclips®, VE=108 Stück ..... 8389.915



**ERAGON**<sup>stitch</sup>

Needle Holder 3.5 mm  
modular system

**ERAGON**<sup>stitch</sup>

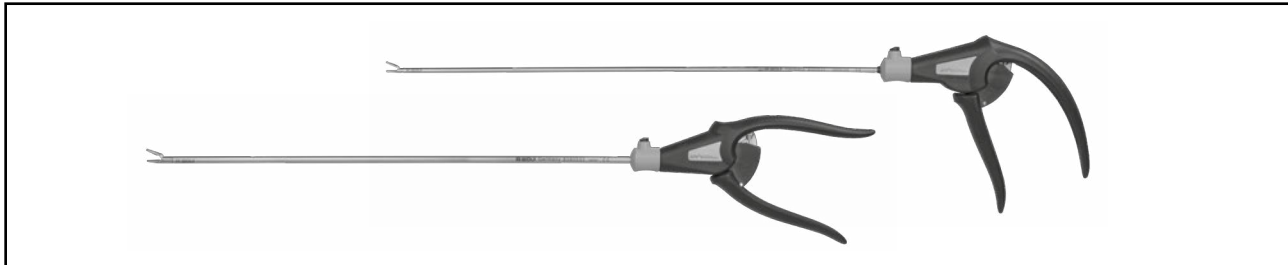
Nadelhalter 3.5 mm  
modulares System

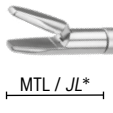

Nadelhalter-Innenteil Needle holder insert	Schaftrohr Sheath tube		Griffvarianten / Handle type		Komplett-Instrument • Innenteil • Schaftrohr • Handgriff  Complete instrument • Jaw insert • Sheath • Handle	
			axial	abgewinkelt / angled		
			einseitig beweglich, mit On-Off-Rastfunktion single movement, with on-off locking mechanism		Bestell-Nr. Order no.	
ERAGON <sup>stitch</sup>	Typen / Types	SL 240 mm	SL 330 mm	8393943		8393944
 Nadelhalter, gerade mit Hartmetalleinsatz MTL= 12 mm Modular needle holder, straight with carbide insert JL= 12 mm	8391505	●		●		<b>83915053</b>
		●			●	
8391506	8391506		●	●		<b>83915063</b>
			●		●	

\* JL = Jaw length when jaws closed (approximate measurements)





\* MTL = Maulteillänge bei geschlossenem Maulteil (gerundete Angaben)

**ERAGON** *stitch*

Needle Holder 5 mm  
modular system

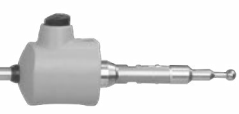
**ERAGON** *stitch*

Nadelhalter 5 mm  
modulares System

Nadelhalter-Innenteil Needle holder insert		Schaffrohr Sheath tube		Griffvarianten / Handle type		<b>Komplett-Instrument</b> • Innenteil • Schaffrohr • Handgriff  <b>Complete instrument</b> • Jaw insert • Sheath • Handle	
				axial	abgewinkelt / angled		
 MTL / JL*				einseitig beweglich, mit On-Off-Rastfunktion <i>single movement, with on-off locking mechanism</i>		Bestell-Nr. Order no.	
							Typen / Types
 <b>Nadelhalter</b> , gerade mit Hartmetalleinsatz MTL= 19 mm <b>Modular needle holder</b> , straight with carbide insert JL= 19 mm	8393507	●		●		<b>83935073</b>	
		●			●	<b>83935074</b>	
	8394507		●	●		●	<b>83945073</b>
			●			●	<b>83945074</b>
 <b>Nadelhalter</b> , gerade, schmal mit Hartmetalleinsatz MTL= 19 mm <b>Modular needle holder</b> , straight, slim with carbide insert JL= 19 mm	8393508	●		●		<b>83935083</b>	
		●			●	<b>83935084</b>	
	8394508		●	●		●	<b>83945083</b>
			●			●	<b>83945084</b>
 <b>Nadelhalter</b> , gerade mit Aufrichtfunktion MTL= 19 mm <b>Modular needle holder</b> , straight with straightening up function JL= 19 mm	8393509	●		●		<b>83935093</b>	
		●			●	<b>83935094</b>	
	8394509		●	●		●	<b>83945093</b>
			●			●	<b>83945094</b>

\* JL = Jaw length when jaws closed (approximate measurements)

\* MTL = Maulteillänge bei geschlossenem Maulteil (gerundete Angaben)





**ERAGON** *stitch*

Needle Holder 5 mm  
modular system

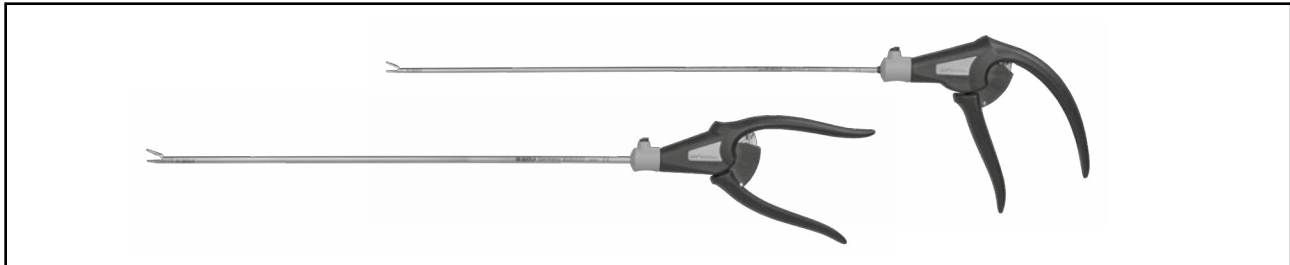
**ERAGON** *stitch*

Nadelhalter 5 mm  
modulares System



Nadelhalter-Innenteil Needle holder insert	Schaftrohr Sheath tube	Griffvarianten / Handle type		Komplett-Instrument • Innenteil • Schaftrohr • Handgriff  Complete instrument • Jaw insert • Sheath • Handle		
		axial	abgewinkelt / angled			
		einseitig beweglich, mit On-Off-Rastfunktion single movement, with on-off locking mechanism		Bestell-Nr. Order no.		
ERAGON <i>stitch</i>	Typen / Types	SL 330 mm	SL 450 mm	8393943	8393944	
 Nadelhalter, rechts gebogen mit Hartmetalleinsatz MTL= 19 mm Modular needle holder, curved right with carbide insert JL= 19 mm	8393518	●		●		<b>83935183</b>
		●			●	
 Nadelhalter, links gebogen mit Hartmetalleinsatz MTL= 19 mm Modular needle holder, curved left with carbide insert JL= 19 mm	8394518		●	●		<b>83945183</b>
			●			●
 Nadelhalter, rechts gebogen mit Hartmetalleinsatz MTL= 19 mm Modular needle holder, curved right with carbide insert JL= 19 mm	8393519	●		●		<b>83935193</b>
		●			●	
 Nadelhalter, links gebogen mit Hartmetalleinsatz MTL= 19 mm Modular needle holder, curved left with carbide insert JL= 19 mm	8394519		●	●		<b>83945193</b>
			●			●

\* JL = Jaw length when jaws closed (approximate measurements)

\* MTL = Maulteillänge bei geschlossenem Maulteil (gerundete Angaben)



**ERAGON**<sub>stitch</sub>  
Accessories

**ERAGON**<sub>stitch</sub>  
Zubehör

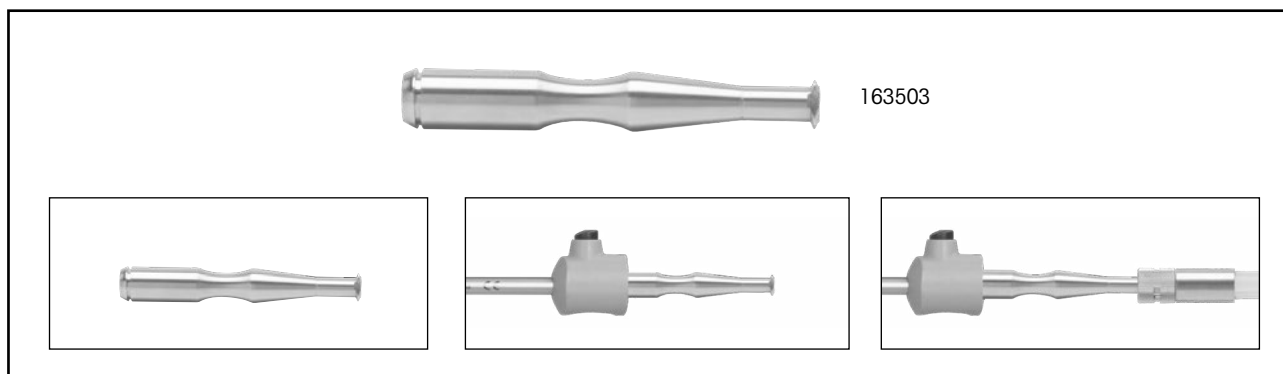

163503

For manual and machine reprocessing:

Für manuelle und maschinelle Aufbereitung:

**Irrigation adapter,**

Ø 9 mm, length 64 mm

for uninsulated sheath tubes ..... 163503







**Spüladapter,**

Ø 9 mm, Länge 64 mm

für unisolierte Schaffrohre ..... 163503

*Needle Holder 3.5 mm / 5 mm*  
*modular system*

*Nadelhalter 3,5 mm / 5 mm*  
*modulares System*

Innenteil mit Schaftrrohr und Spülanschluss <i>Inner section with sheath tube and irrigation tap</i>		Axialer Handgriff / Axial handle		Komplet-Instrument • Innenteil mit Schaftrrohr • Griff  Complete instrument • Inner section with sheath tube • Handle		
				8393.941		
		Typen / Types	Ø	SL / SL	8393.941	Typen / Types
<b>Modularer Nadelhalter</b> , gerade mit Hartmetalleinsatz <i>Modular needle holder, straight with carbide insert</i>		8391.504	3.5 mm	340 mm	●	<b>8391.501</b>
 <b>Modularer Nadelhalter</b> , gerade für gerade Nadeln <i>Modular needle holder, straight for straight needles</i>		8393.504	5 mm	340 mm	●	<b>8393.501</b>
 <b>Modularer Nadelhalter</b> , gerade mit Hartmetalleinsatz <i>Modular needle holder, straight with carbide insert</i>		8393.505	5 mm	340 mm	●	<b>8393.502</b>
		8394.505	5 mm	430 mm	●	<b>8394.502</b>
 <b>Modularer Nadelhalter</b> , rechts gebogen mit Hartmetalleinsatz <i>Modular needle holder, curved right with carbide insert</i>		8393.514	5 mm	340 mm	●	<b>8393.511</b>
		8394.514	5 mm	430 mm	●	<b>8394.511</b>
 <b>Modularer Nadelhalter</b> , links gebogen mit Hartmetalleinsatz <i>Modular needle holder, curved left with carbide insert</i>		8393.515	5 mm	340 mm	●	<b>8393.512</b>
		8394.515	5 mm	430 mm	●	<b>8394.512</b>
 <b>Modularer Multifunktions*-Nadelhalter nach Sarbu</b> <i>Modular multifunction* needle holder by Sarbu</i>		8393.506	5 mm	340 mm	●	<b>8393.503</b>
		8394.506	5 mm	430 mm	●	<b>8394.503</b>



\* with automatic needle alignment mechanism and cutting edge

\* mit automatischer Nadelaufstellvorrichtung und Schneidkante

11

## Needle Holder 5 mm

## Nadelhalter 5 mm





Axially aligned handle with locking mechanism		Axialer Handgriff mit Rastmechanismus	
			
	NL / WL 310 mm	Typen / Types	
 <p><b>Nadelhalter</b>, rechts gebogen nach Messroghli <b>Needle holder</b>, curved right by Messroghli</p>	●	<b>8383.534</b>	





**ERAGON** modular

modular knot pusher 5 mm

**ERAGON** modular

modularer Knotenschieber 5 mm

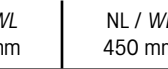
<p><b>ERAGON</b> axial</p> <p>Alle Innenteile und Schaffrohre sind ebenfalls mit <b>ERAGONaxial</b> kombinierbar. All jaw inserts and sheaths can also be combined with <b>ERAGONaxial</b>.</p>	Griffvarianten / Handle type				<p>Drehradaufsatz, <b>ERAGONaxial Knob attachment, ERAGONaxial</b></p>  <p>autoklavierbar / autoclavable</p>
					
Typen / Types	83930082	83930083	83930084	83930085	8988

<p>Innenteil / Jaw insert</p>  <p>MTL / JL*</p>	Schaffrohr, isoliert Sheath tube, insulated		Griffvarianten / Handle type		<p><b>Komplett-Instrument</b></p> <ul style="list-style-type: none"> <li>• Innenteil</li> <li>• Schaffrohr</li> <li>• Handgriff</li> </ul> <p><b>Complete instrument</b></p> <ul style="list-style-type: none"> <li>• Jaw insert</li> <li>• Sheath</li> <li>• Handle</li> </ul>
				mit Sperre, drehbar with locking mechanism, rotatable	
Typen / Types	NL / WL 330 mm	NL / WL 450 mm	83930072		Typen / Types
	8393.345	●	●	●	<b>83933457</b>
<p><b>Extrakorporaler Knotenschieber,</b> mit distaler Aussparung, doppelbeweglich, MTL= 17 mm <b>Extracorporeal knot pusher,</b> with distal fork, double jaw action, JL= 17 mm</p>	8394345	●	●	●	<b>83943457</b>

\* JL = Jaw length when jaws closed (approximate measurements)

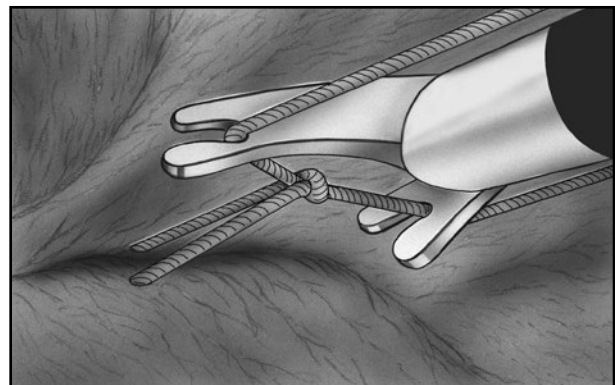

\* MTL = Maulteillänge bei geschlossenem Maulteil (gerundete Angaben)





**Extrakorporale Knotentechnik**  
**Extracorporeal knotting technique**

*Knot Pusher 5 mm*  
for endoscopic suturing

Knotenschieber 5 mm  
zum endoskopischen Nähen

		
	NL / WL 330 mm	Typen / Types
 <b>Knotenschieber,</b> für intraabdominale Knoten <b>Knot pusher,</b> for intra-abdominal knots	●	<b>8383.55</b>
 <b>Knotenschieber,</b> für extrakorporale Knoten <b>Knot pusher,</b> for extracorporeal knots	●	<b>8383.551</b>

11

		
	NL / WL 330 mm	Typen / Types
 <b>Extrakorporaler Knotenschieber nach Bueß</b> mit distaler Einkerbung und lateraler Öffnung zur optimalen Knotenführung, extrem atraumatische Spitze zur Benutzung als Taststab  <b>Extracorporeal knot pusher by Bueß</b> with distal notch and lateral opening for optimum knotting, extremely atraumatic tip for use as probe	●	<b>8383.552</b>

## Trocar-Site Closure Device for visualized Fascia Closure by Busche

## Endoskopisch kontrolliertes Faszienschluss-System nach Busche

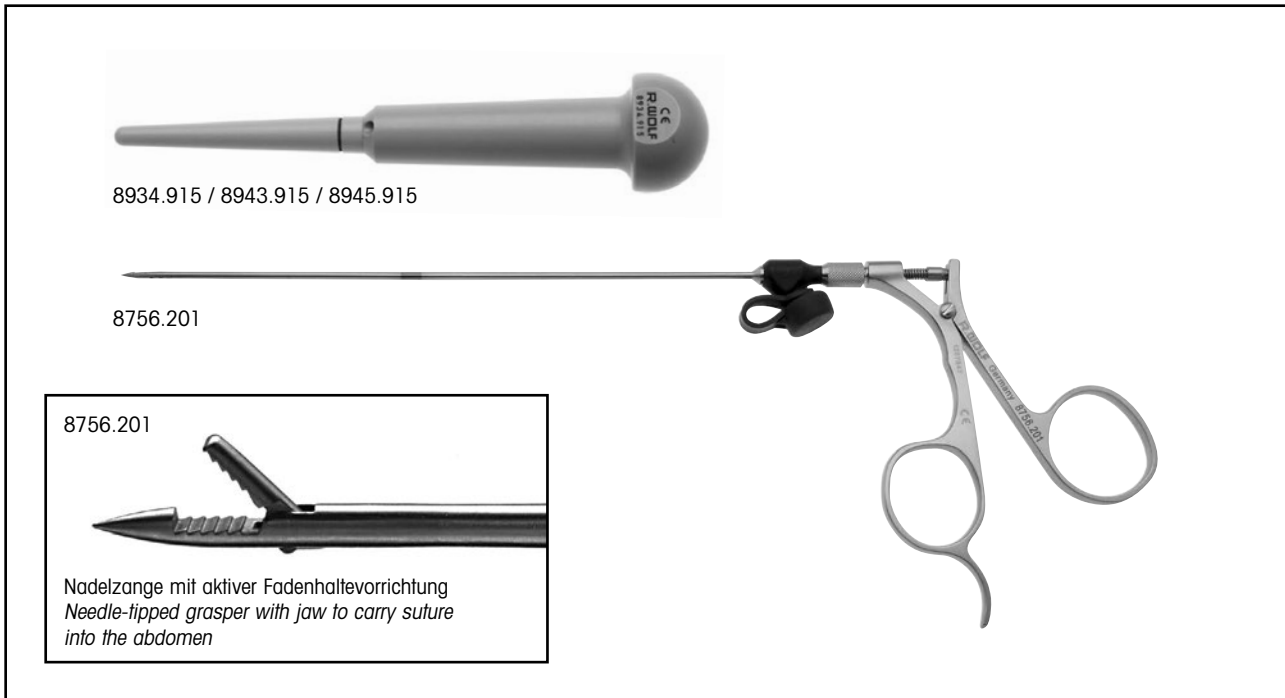

The extended tip of the device allows easy insertion of the cone which then effectively plugs the hole left when the cannula is removed. This preserves the pneumoperitoneum which can be maintained to ensure a safe distance between abdominal wall and the organs. The marking on the cone indicates the ideal position of placement for the ligature.

A suture is grasped with the special grasper and passed through the hole in the cone. This traverses the muscle, fascia and peritoneal layers. The suture is released inside the peritoneal cavity. To complete the stitch on the other side, the device is kept in place and turned through 180°. The grasper is reinserted and the intraperitoneal end of the suture is grasped and withdrawn from the peritoneal cavity as the cone is removed. The suture is tied extracorporeal under direct visual control.

Additional application is suture ligation of bleeding inferior epigastric vessels by using just the needle tipped grasper.

<b>Closure cone</b>	
10 - 12 mm .....	8934.915
12 - 15 mm .....	8943.915
15 - 20 mm .....	8945.915

<b>Needle-tipped grasper</b>	
with jaw to carry suture, Ø 2 mm, WL 160 mm, with rinsing port .....	8756.201

Der joystickartige Dichtkonus findet seinen Weg durch die einzelnen Schichten und verschließt die Inzision um das Pneumoperitoneum wieder herzustellen. Dadurch entsteht ein Sicherheitsabstand zwischen der Bauchdecke und den Organen. Die Markierung am Konus signalisiert dabei die ideale Position für die Ligatur.

Mit der Nadelzange wird der Faden durch die Bohrung des Dichtkonus eingebracht und im Bauchraum deponiert. Nach Zurückziehen der Nadelzange und Drehen des Konus um 180° wird die Zange wieder eingeführt, der Faden gegriffen und der Knoten unter endoskopischer Kontrolle extrakorporal durchgeführt.

Die Nadelzange ist ausserdem sehr gut als Notfallnadel zur Unterbindung von Bauchdeckenblutungen geeignet.

<b>Dichtkonus</b>	
10 - 12 mm .....	8934.915
12 - 15 mm .....	8943.915
15 - 20 mm .....	8945.915

<b>Nadelzange</b>	
mit aktiver Fadenhaltevorrichtung Ø 2 mm, NL 160 mm, mit Spülanschluss .....	8756.201

*Cannulas 2 mm / 3 mm*  
*with Luer connector*



*Kanülen 2 mm / 3 mm*  
*mit Luer-Anschluss*



	∅	NL / WL 240 mm	Typen / Types
<i>Injektions- und Aspirationskanüle</i> <i>Injection and aspiration cannula</i>	1.4 / 2.0 mm	240 mm	<b>8309.241</b>
 <i>Injektions- und Aspirationskanüle</i> <i>Injection and aspiration cannula</i>	3.0 mm	310 mm	<b>8379.732</b>

**Cannulas 5 mm**  
with Luer connector

**Kanülen 5 mm**  
mit Luer-Anschluss

		8383.65	8384.60		
		Ø mm Spitze / Tip	NL / WL 345 mm	NL / WL 415 mm	Typen / Types
	<b>Injektions- und Punktionskanüle</b> mit Luer-Anschluss 3 mm <i>Injection and puncture cannula</i> with 3 mm Luer connector	0.7 (22 G)	●	●	<b>8384.60</b>
	<b>Injektionskanüle</b> mit Luer-Anschluss 3 mm <i>Injection cannula</i> with 3 mm Luer connector	1.8 (15 G)	●		<b>8383.65</b>
	hierzu: <b>Einführungshülse</b> also: <i>Insertion sleeve</i>	(Diese Hülse verhindert eine Beschädigung der Kanülenspitze beim Öffnen des Trokarhülseventilis.)  (This sleeve prevents the tip of the cannula being damaged when opening the valve of the trocar sleeve.)			<b>8383.00</b>

12







## Cannulas 5 mm

with suction control and Luer connector



## Kanülen 5 mm

mit Sogsteuerung und Luer-Anschluss

		
	NL / WL 315 mm	Typen / Types
 <p><b>Punktionskanüle</b> mit Sogsteuerung und 4 mm- Luer-Anschluss <b>Puncture cannula</b> with suction control and 4 mm Luer connector</p>		<b>8383.49</b>
 <p>hierzu: <b>Einführungshülse</b> also: <b>Insertion sleeve</b></p>	<p>(Diese Hülse verhindert eine Beschädigung der Kanülenspitze beim Öffnen des Trokarhülsevenventils.)</p> <p>(This sleeve prevents the tip of the cannula being damaged when opening the valve of the trocar sleeve.)</p>	<b>8383.00</b>



Probe 3.5 mm



Taststab 3,5 mm

			
	∅	NL / WL	Type / Type
 <b>Taststab, graduiert</b> <i>Probe, graduated</i>	3.5 mm	350 mm	<b>8379.672</b>

Probes / Manipulator  
5 mm

Taststäbe / Manipulator  
5 mm

			
	NL / WL 330 mm	NL / WL 445 mm	Typen / Types
 <b>Taststab, graduiert,</b> zur Palpation und Größenmessung <b>Probe, graduated,</b> for palpation and measurement	●		<b>8383.66</b>
		●	<b>8384.66</b>

		
	GL / TL 450 mm	Type / Type
 <b>Manipulator mit kugelförmigen Spitzen,</b> beidseitig nutzbar, Ø 4 mm / Ø 5 mm <b>Manipulator with spherical tips,</b> usable at both ends, Ø 4 mm / Ø 5 mm	●	<b>838369</b>

*Myoma Screw 5 mm / 10 mm*

Myombohrer 5 mm / 10 mm



	Ø	NL / WL	Type / Type
	5 mm	340 mm	<b>8383.611</b>
<b>Myombohrer, starr</b> <i>Myoma screw, rigid</i>	10 mm	340 mm	<b>8385.301</b>

*Instrument Set for Bariatric Surgery*

*Adipositas-Instrumenten-Set*

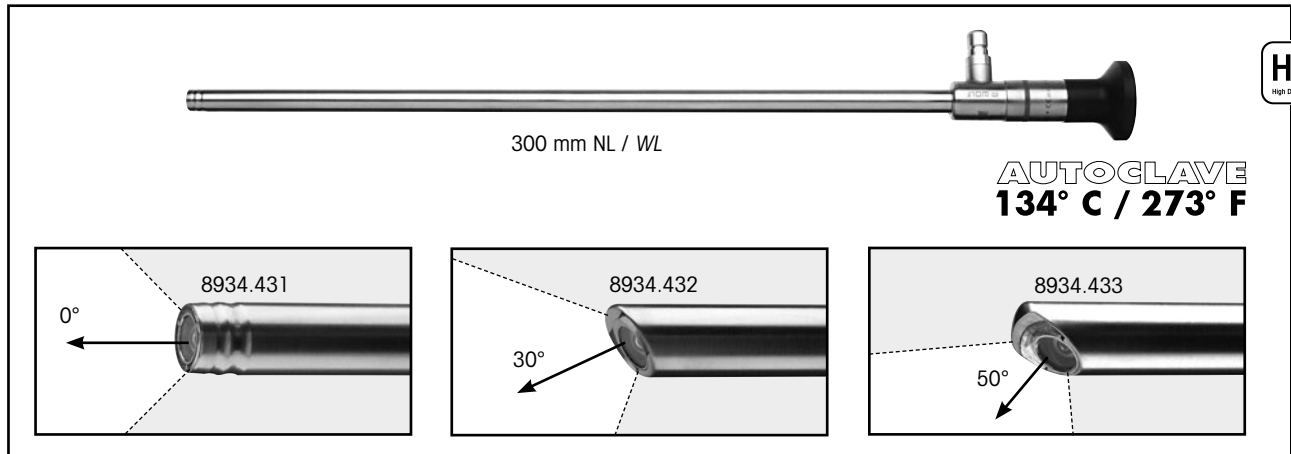

**PANOVIEW telescope, Ø 10 mm, istortion-free,**

0° .....	8934.431
30° .....	8934.432
50° .....	8934.433

**PANOVIEW-Optik, Ø 10 mm, verzeichnungsfrei,**

0° .....	8934.431
30° .....	8934.432
50° .....	8934.433

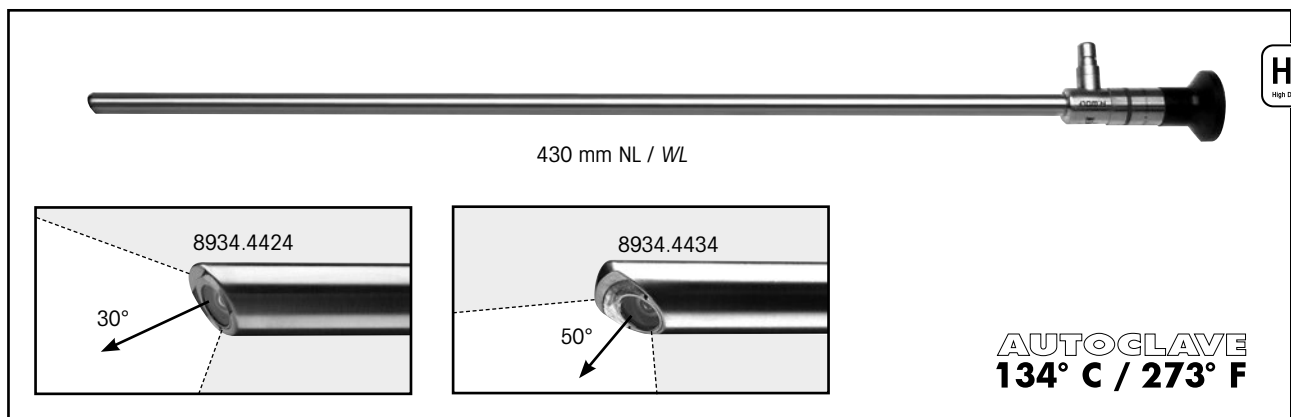

**PANOVIEW PLUS telescope, Ø 10 mm,**

30° .....	8934.4424
50° .....	8934.4434

**PANOVIEW PLUS-Optik, Ø 10 mm,**

30° .....	8934.4424
50° .....	8934.4434

*Recommended light cable:*

**Fiber light cable bundle, Ø 5.0 mm, 2.3 m long consisting of:**  
 Fiber light cable (80665023), adapter projector side (8095.07) and  
 adapter endoscope side (809509)..... 806650231  
 (for maximum light transmission)

**Fiber light cable bundle *Fusion*, high-temperature resistant,**  
 Ø 5.0 mm, 2.3 m long consisting of:  
 Fiber light cable (80655023), adapter projector side (8095.07) and  
 adapter endoscope side (809509)..... 806550231  
 (for maximum light transmission)

*Accessories:*

**Reprocessing basket** (for telescopes 8934.4424 / .4434)  
 (L x W x H) 610 x 59 x 54 mm ..... 38022.111

*Empfohlene Lichtleitkabel:*

**Fiber Lichtleiter komplett, Ø 5,0 mm, 2,3 m lang bestehend aus:**  
 Fiber Lichtleiter (80665023), Adapter projektorseitig (8095.07) und  
 Adapter endoskopseitig (809509)..... 806650231  
 (für maximale Lichttransmission)

**Fiber Lichtleiter komplett *Fusion*, hochtemperaturbeständig,**  
 Ø 5,0 mm, 2,3 m lang bestehend aus:  
 Fiber Lichtleiter (80655023), Adapter projektorseitig (8095.07) und  
 Adapter endoskopseitig (809509)..... 806550231  
 (für maximale Lichttransmission)

*Zubehör:*

**Aufbereitungskorb** (für Optiken 8934.4424 / .4434)  
 (L x B x H) 610 x 59 x 54 mm ..... 38022.111

*Instrument Set for Bariatric Surgery*

**Adipositas-Instrumenten-Set**

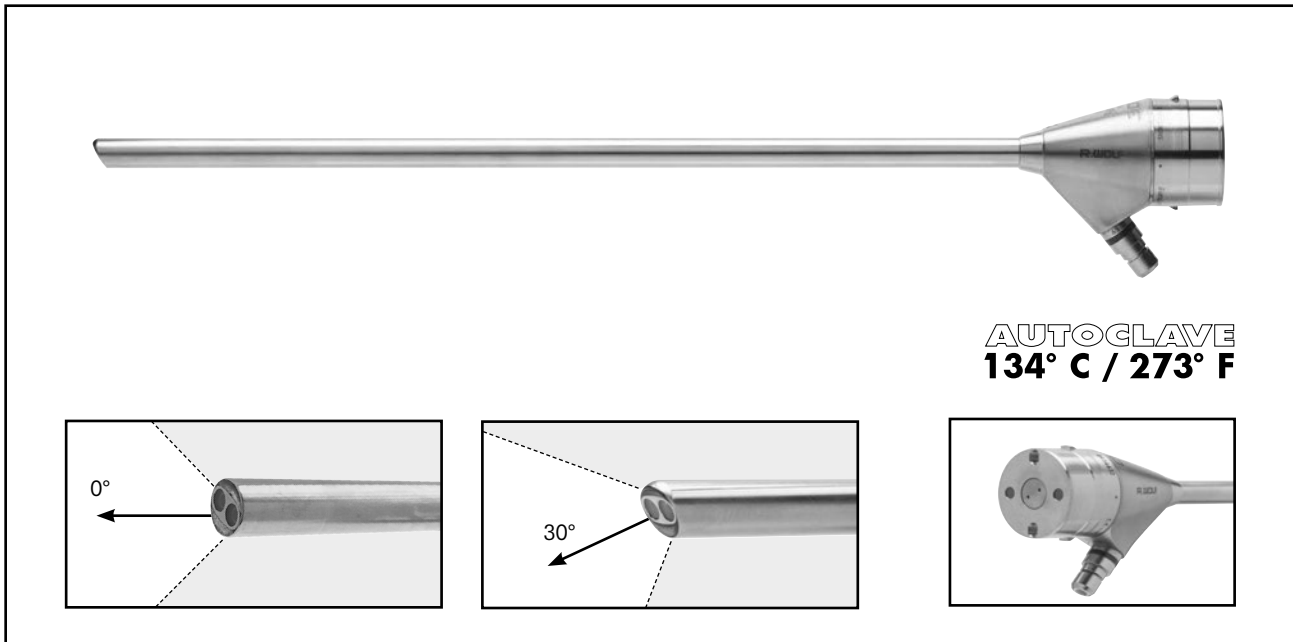

**3DHD telescope bundle, Ø 10 mm, 0°, distortion-free,**  
 consisting of:  
 3DHD telescope (8934631), 300 mm WL  
 and Reprocessing basket (38023111) ..... 89346311  
 3DHD telescope (89344631), 430 mm WL  
 and Reprocessing basket (38023111) ..... 893446311

**3DHD telescope bundle, Ø 10 mm, 30°, distortion-free,**  
 consisting of:  
 3DHD telescope (8934632), 300 mm WL  
 and Reprocessing basket (38023111) ..... 89346321  
 3DHD telescope (89344632), 430 mm WL  
 and Reprocessing basket (38023111) ..... 893446321

recommended light cable:  
**Fiber light cable bundle Fusion<sup>®</sup>**, high-temperature resistant,  
 Ø 5.0 mm, 2.3 m long consisting of:  
 Fiber light cable (80655023), adapter projector-side (8095.07) and  
 adapter endoscope-side (809509)..... 806550231  
 (for maximum light transmission)

**3D Endoskop komplett, Ø 10 mm, 0°, verzeichnungsfrei,**  
 bestehend aus:  
 3DHD Endoskop (8934631), 300 mm NL  
 und Aufbereitungskorb (38023111) ..... 89346311  
 3DHD Endoskop (89344631), 430 mm NL  
 und Aufbereitungskorb (38023111) ..... 893446311

**3D Endoskop komplett, Ø 10 mm, 30°, verzeichnungsfrei,**  
 bestehend aus:  
 3DHD Endoskop (8934632), 300 mm NL  
 und Aufbereitungskorb (38023111) ..... 89346321  
 3DHD Endoskop (89344632), 430 mm NL  
 und Aufbereitungskorb (38023111) ..... 893446321

Empfohlene Lichtleiter:  
**Fiber Lichtleiter komplett Fusion<sup>®</sup>**, hochtemperaturbeständig,  
 Ø 5,0 mm, 2,3 m lang bestehend aus:  
 Fiber Lichtleiter (80655023), Adapter projektorseitig (8095.07) und  
 Adapter endoskopseitig (809509)..... 806550231  
 (für maximale Lichttransmission)

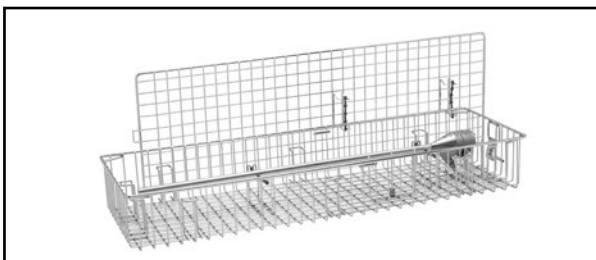









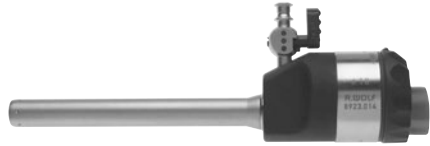

**Aufbereitungskorb** für 3D Endoskop  
 Maße (L x B x H): 582,5 x 200 x 80 mm ..... 38023111

**Reprocessing basket** for 3D telescope  
 Dimensions (L x W x H): 582,5 x 200 x 80 mm ..... 38023111

*Instrument Set for Bariatric Surgery*

*Adipositas-Instrumenten-Set*

RIWO-ART-Trokarhülsen mit Magnet-Kugel-Ventil				Trokar, Spitze kegelig-spitz	Trokar, Spitze dreikantig
					
<i>RIWO-ART trocar sleeves with magnetic-ball-valve</i>	NL / WL	Durchlass / Capacity	Typen / Types	<i>Trocar, conical tip</i>	<i>Trocar, pyramidal tip</i>
Metallrohr mit Gewinde, distal gerade	100 mm	5.5 mm	<b>8921.024</b>	<b>8921.113</b>	<b>8921.123</b>
 <i>Metal with retaining thread, straight distal tip</i>	150 mm	5.5 mm	<b>8921.026</b>	<b>8921.115</b>	<b>8921.125</b>
Metallrohr mit Gewinde, distal gerade	100 mm	10 mm	<b>8923.024</b>	<b>8923.113</b>	<b>8923.123</b>
 <i>Metal with retaining thread, straight distal tip</i>	150 mm	10 mm	<b>8923.026</b>	<b>8923.115</b>	<b>8923.125</b>
Metallrohr, glatt, distal gerade	100 mm	12,5 mm	<b>8924.014</b>	<b>8924.113</b>	<b>8924.123</b>
 <i>Metal sleeve, standard, straight distal tip</i>	150 mm	12,5 mm	<b>8924.016</b>	<b>8924.115</b>	<b>8924.125</b>
Metallrohr mit Gewinde, distal gerade	150 mm	12,5 mm	<b>8924.026</b>	<b>8924.115</b>	<b>8924.125</b>
 <i>Metal with retaining thread, straight distal tip</i>					





TROTEC-Trokar bestehend aus: <i>TROTEC trocar consisting of:</i>			Für RIWO ART-Trokarhülse mit: <i>For RIWO ART trocar sleeves:</i>	
 Schaft mit Lanzettenspitze, zweikantig / <i>Sheath with two-edged lancet tip</i>	 Griff mit federndem Schutzstab / <i>Handle with spring-mounted protective rod</i>	TROTEC-Trokar komplett <i>TROTEC trocar complete</i>		
<b>8923.134</b>	<b>8923.135</b>	<b>8923.133</b>	Nutzlänge <i>Working length</i>	Ø
<b>8924.134</b>	<b>8923.135</b>	<b>8924.133</b>	100 mm	10.0 mm
			100 mm	12.5 mm









- Spare ball, 1 piece, capacity 5.5 mm.....8921.901
- Spare ball, 1 piece, capacity 10 mm.....8923.901
- Spare o-rings, PACK=10 PCS, capacity 5.5 mm .....8921.951
- Spare o-rings, PACK=10 PCS, capacity 10 mm .....8923.951
- Spare sealing caps, PACK=10 PCS, capacity 5.5 mm, blue.....89.02
- Spare sealing caps, PACK=10 PCS, capacity 10 mm, red .....89.08
- Spare plug, PACK= 5 .....896.0002**

- Ersatzkugel, 1 Stück, Durchlass 5,5 mm.....8921.901**
- Ersatzkugel, 1 Stück, Durchlass 10 mm.....8923.901**
- Ersatz-O-Ringe, VE=10 ST, Durchlass 5,5 mm .....8921.951**
- Ersatz-O-Ringe, VE=10 ST, Durchlass 10 mm .....8923.951**
- Ersatz-Dichtungskappen, VE=10 ST, Durchlass 5,5 mm, blau ....89.02**
- Ersatz-Dichtungskappen, VE=10 ST, Durchlass 10 mm, rot.....89.08**
- Ersatz-Hahnküken, VE=5 ST .....896.0002**

**Instrument Set for Bariatric Surgery**  
modular instruments 5 mm

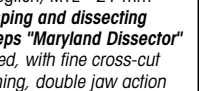
**Adipositas-Instrumenten-Set**  
modulare Instrumente 5 mm

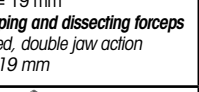
 Alle Innenteile und Schaftröhre sind ebenfalls mit <b>ERAGONaxial</b> kombinierbar. <i>All jaw inserts and sheaths can also be combined with <b>ERAGONaxial</b>.</i>	Griffvarianten / Handle type		Drehradaufsatz, <b>ERAGONaxial</b> Knob attachment, <b>ERAGONaxial</b>  autoklavierbar / autoclavable
	HF / mono  ohne Sperre, drehbar <i>without locking mechanism, rotatable</i>	HF / mono  mit Sperre, drehbar <i>with locking mechanism, rotatable</i>	
Typen / Types	83930083	83930084	8988

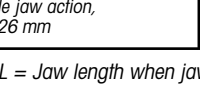
Innenteil <i>Jaw insert</i>   MTL / JL*	Schaftröhre, isoliert <i>Sheath tube, insulated</i>		Griffvarianten / Handle type		<b>Komplett-Instrument</b> • Innenteil • Schaftröhre • Handgriff <b>Complete instrument</b> • Jaw insert • Sheath • Handle
	NL / WL 330 mm	NL / WL 450 mm	HF / mono  mit Sperre, drehbar <i>with locking mechanism, rotatable</i>		
Typen / Types	8393933	8394933	83930074		Typen / Types
 <b>Greif- und Dissektionszange "Maryland Dissektor"</b> gebogen, mit feiner Verzahnung, doppelbeweglich, MTL= 21 mm <b>Grasping and dissecting forceps "Maryland Dissector"</b> curved, with fine cross-cut toothing, double jaw action JL= 21 mm	8393.281	●		●	<b>83932817</b>
 <b>Greif- und Dissektionszange "Maryland Dissektor"</b> gebogen, mit feiner Verzahnung, doppelbeweglich, MTL= 21 mm <b>Grasping and dissecting forceps "Maryland Dissector"</b> curved, with fine cross-cut toothing, double jaw action JL= 21 mm	8394.281		●	●	<b>83942817</b>
 <b>Greif- und Dissektionszange</b> gebogen, doppelbeweglich, MTL= 19 mm <b>Grasping and dissecting forceps</b> curved, double jaw action JL= 19 mm	8393240	●		●	<b>83932407</b>
 <b>Greif- und Dissektionszange</b> gebogen, doppelbeweglich, MTL= 19 mm <b>Grasping and dissecting forceps</b> curved, double jaw action JL= 19 mm	8394240		●	●	<b>83942407</b>
 <b>Greif- und Dissektionszange</b> , gefensternt mit feiner Querverzahnung, einseitig beweglich, MTL= 26 mm <b>Grasping and dissecting forceps</b> , perforated, fine horizontal serrations, single jaw action, JL= 26 mm	8393.184	●		●	<b>83931847</b>
 <b>Greif- und Dissektionszange</b> , gefensternt mit feiner Querverzahnung, einseitig beweglich, MTL= 26 mm <b>Grasping and dissecting forceps</b> , perforated, fine horizontal serrations, single jaw action, JL= 26 mm	8394.184		●	●	<b>83941847</b>

\* JL = Jaw length when jaws closed (approximate measurements)

\* MTL = Maulteillänge bei geschlossenem Maulteil (gerundete Angaben)



HF connecting cable see page BDE 163.





HF-Anschlusskabel siehe Blatt BDE 163.



*Instrument Set for Bariatric Surgery*  
*modular instruments 5 mm*

*Adipositas-Instrumenten-Set*  
*modulare Instrumente 5 mm*

 <p>Alle Innenteile und Schaftrohre sind ebenfalls mit <b>ERAGONaxial</b> kombinierbar. <i>All jaw inserts and sheaths can also be combined with ERAGONaxial.</i></p>	Griffvarianten / Handle type		<p>Drehradaufsatz, <b>ERAGONaxial</b> <i>Knob attachment, ERAGONaxial</i></p>  <p>autoklavierbar / autoclavable</p>
	 <p>mit Sperre, drehbar <i>with locking mechanism, rotatable</i></p>		
Typen / Types	83930082		8988





<p>Innenteil <i>Jaw insert</i></p>   <p>MTL / JL*</p>	Schaftrohr, isoliert <i>Sheath tube, insulated</i>		Griffvarianten / Handle type		<p><b>Komplett-Instrument</b></p> <ul style="list-style-type: none"> <li>• Innenteil</li> <li>• Schaftrohr</li> <li>• Handgriff</li> </ul> <p><b>Complete instrument</b></p> <ul style="list-style-type: none"> <li>• Jaw insert</li> <li>• Sheath</li> <li>• Handle</li> </ul>
	Typen / Types	NL / WL 330 mm	NL / WL 450 mm	mit Sperre, drehbar <i>with locking mechanism, rotatable</i>	
 <p><b>Greifzange</b> atraumatisch, gefensternt, feine Querverzahnung, doppelbeweglich, MTL= 25 mm <i>Grasping forceps</i> atraumatic, fenestrated, fine cross toothing double jaw action, JL= 25 mm</p>	8393250	●		●	<b>83932507</b>
	8394250		●	●	<b>83942507</b>
 <p><b>Atraumatische Greifzange</b> doppelt gefensternt, gebogen, einfach beweglich, MTL= 32 mm <i>Atraumatic grasping forceps</i> with double window, curved, single jaw action, JL= 32 mm</p>	8393229	●		●	<b>83932297</b>
	8394229		●	●	<b>83942297</b>
 <p><b>Atraumatische Darmfasszange</b> einfach gefensternt, doppelbeweglich, MTL= 38 mm <i>Atraumatic intestinal grasping forceps</i>, single fenestration, double jaw action JL= 38 mm</p>	8393249	●		●	<b>83932497</b>
	8394249	●		●	<b>83942497</b>







\* JL = Jaw length when jaws closed (approximate measurements)

\* MTL = Maulteillänge bei geschlossenem Maulteil (gerundete Angaben)

**Instrument Set for Bariatric Surgery**  
modular instruments 5 mm

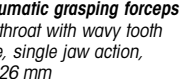
**Adipositas-Instrumenten-Set**  
modulare Instrumente 5 mm

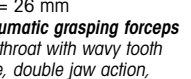
 Alle Innenteile und Schaffrohre sind ebenfalls mit <b>ERAGONaxial</b> kombinierbar. <i>All jaw inserts and sheaths can also be combined with <b>ERAGONaxial</b>.</i>	Griffvarianten / Handle type		Drehradaufsatz, <b>ERAGONaxial</b> Knob attachment, <b>ERAGONaxial</b>  autoklavierbar / autoclavable
	 mit Sperre, drehbar <i>with locking mechanism, rotatable</i>	 HF / mono mit Sperre, drehbar <i>with locking mechanism, rotatable</i>	

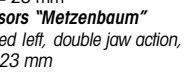
Innenteil <i>Jaw insert</i>   MTL / JL*	Schaffrohr, isoliert <i>Sheath tube, insulated</i>		Griffvarianten / Handle type		Komplet-Instrument • Innenteil • Schaffrohr • Handgriff Complete instrument • Jaw insert • Sheath • Handle
	NL / WL 330 mm	NL / WL 450 mm	mit Sperre, drehbar <i>with locking mechanism, rotatable</i>	ohne Sperre, drehbar <i>without locking mechanism, rotatable</i>	
 <b>Atraumatische Greifzange</b> Maulkehle mit gewelltem Zahnrand, einfach beweglich, MTL= 26 mm <i>Atraumatic grasping forceps jaw throat with wavy tooth edge, single jaw action, JL= 26 mm</i>	8393.292	●	●	●	83932925
 <b>Atraumatische Greifzange</b> Maulkehle mit gewelltem Zahnrand, einfach beweglich, MTL= 26 mm <i>Atraumatic grasping forceps jaw throat with wavy tooth edge, single jaw action, JL= 26 mm</i>	8394.292	●	●	●	83942925
 <b>Atraumatische Greifzange</b> Maulkehle mit gewelltem Zahnrand, doppel- beweglich, MTL= 26 mm <i>Atraumatic grasping forceps jaw throat with wavy tooth edge, double jaw action, JL= 26 mm</i>	8393.293	●	●	●	83932935
 <b>Atraumatische Greifzange</b> Maulkehle mit gewelltem Zahnrand, doppel- beweglich, MTL= 26 mm <i>Atraumatic grasping forceps jaw throat with wavy tooth edge, double jaw action, JL= 26 mm</i>	8394.293	●	●	●	83942935
 <b>Schere „Metzenbaum“</b> , links gebogen, doppelbeweglich, MTL= 23 mm <i>Scissors „Metzenbaum“ curved left, double jaw action, JL= 23 mm</i>	8393.041	●	●	●	83930417
 <b>Schere „Metzenbaum“</b> , links gebogen, doppelbeweglich, MTL= 23 mm <i>Scissors „Metzenbaum“ curved left, double jaw action, JL= 23 mm</i>	8394.041	●	●	●	83940417

\* JL = Jaw length when jaws closed (approximate measurements)

\* MTL = Maulteillänge bei geschlossenem Maulteil (gerundete Angaben)

HF connecting cable see page BDE 163.

HF-Anschlusskabel siehe Blatt BDE 163.

*Instrument Set for Bariatric Surgery*

**ERAGON** modular sheath tube with cm scale

*Adipositas-Instrumenten-Set*



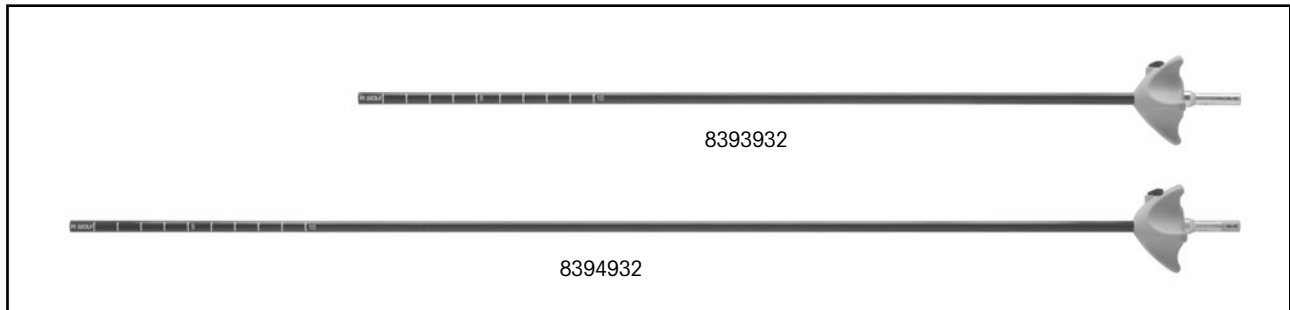

**ERAGON** modular Schaffrohr mit cm-Markierung







	∅	NL / WL	Typen / Types
 <p><b>ERAGON</b> modular Schaffrohr, monopolar, mit distaler cm-Markierung <b>ERAGON</b> modular sheath tube, monopolar, with distal cm scale</p>	5 mm	330 mm	<b>8393932</b>
		450 mm	<b>8394932</b>

*Instrument Set for Bariatric Surgery*  
Gastric Band Manipulator 5 mm

*Adipositas-Instrumenten-Set*  
Gastric Band Manipulator 5 mm

 Alle Innenteile und Schaffrohre sind ebenfalls mit <b>ERAGONaxial</b> kombinierbar. <i>All jaw inserts and sheaths can also be combined with ERAGONaxial.</i>	Griffvarianten / Handle type		Drehradaufsatz, ERAGONaxial Knob attachment, ERAGONaxial  autoklavierbar / autoclavable
	 mit Sperre, drehbar <i>with locking mechanism, rotatable</i>	 mit Sperre, nicht drehbar <i>with locking mechanism, not rotatable</i>	
Typen / Types	83930082	83930085	





Innenteil / Jaw insert  MTL / JL*	Schaffrohr, isoliert Sheath tube, insulated		Griffvarianten / Handle type		<b>Komplett-Instrument</b> • Innenteil • Schaffrohr • Handgriff <b>Complete instrument</b> • Jaw insert • Sheath tube • Handle
	 NL / WL 330 mm   NL / WL 450 mm	 mit Sperre, drehbar <i>with locking mechanism, rotatable</i>		83930072	
Typen / Types	8393933	8394933	83930072		Typen / Types
 8393253	●		●		<b>83932537</b>
Gastric Band Manipulator, MTL= 45 mm Gastric band manipulator, JL= 45 mm 8394253		●	●		<b>83942537</b>









\* JL = Jaw length when jaws closed (approximate measurements)

\* MTL = Maulteillänge bei geschlossenem Maulteil (gerundete Angaben)

*Instrument Set for Bariatric Surgery*  
*modular Instruments 10 mm*

*Adipositas-Instrumenten-Set*  
*modulare Instrumente 10 mm*

 <p>Alle Innenteile und Schaffrohre sind ebenfalls mit <b>ERAGONaxial</b> kombinierbar. <i>All jaw inserts and sheaths can also be combined with ERAGONaxial.</i></p>	Griffvarianten / Handle type		<p>Drehradaufsatz, ERAGONaxial <i>Knob attachment, ERAGONaxial</i></p>  <p>autoklavierbar / autoclavable</p>
	 <p>mit Sperre, drehbar <i>with locking mechanism, rotatable</i></p>	 <p>mit Sperre, nicht drehbar <i>with locking mechanism, not rotatable</i></p>	
Typen / Types	83930082	83930085	8988





<p>Innenteil / Jaw insert</p>   <p>MTL / JL*</p>	Schaffrohr, unisoliert <i>Sheath tube, uninsulated</i>		Griffvarianten / Handle type		<p><b>Komplett-Instrument</b></p> <ul style="list-style-type: none"> <li>• Innenteil</li> <li>• Schaffrohr</li> <li>• Handgriff</li> </ul> <p><b>Complete instrument</b></p> <ul style="list-style-type: none"> <li>• Jaw insert</li> <li>• Sheath tube</li> <li>• Handle</li> </ul>
	 <p>NL / WL 330 mm</p>	 <p>NL / WL 450 mm</p>	 <p>mit Sperre, ohne HF-Anschluss <i>with locking mechanism, without HF connector</i></p>		
Typen / Types	8395902	8396902	83930072		Typen / Types
 <p><b>Greif- / Dissektionszange "Maryland"</b>, doppelbeweglich MTL= 36 mm <i>Grasping and dissecting forceps, "Maryland", double jaw action, JL= 36mm</i></p>	8395.225	●	●	●	<b>83952257</b>
	8396225	●	●	●	<b>83962257</b>
 <p><b>Dissektionszange</b>, rechtwinkelig gebogen, doppelbeweglich, MTL= 35 mm <i>Dissecting forceps, right angled, both jaw action, JL= 35 mm</i></p>	8395.226	●	●	●	<b>83952268</b>
	8396226	●	●	●	<b>83962267</b>
 <p><b>Atraumatische Greifzange "Babcock"</b>, große distale Greiffläche mit feiner Querverzahnung, doppelbeweglich, MTL= 42 mm <i>Atraumatic grasping forceps, "Babcock", large distal grasping surface with fine horizontal serration, double jaw action, JL= 42 mm</i></p>	8395.187	●	●	●	<b>83951877</b>
	8396187	●	●	●	<b>83961877</b>

\* JL = Jaw length when jaws closed (approximate measurements)

\* MTL = Maulteillänge bei geschlossenem Maulteil (gerundete Angaben)

*Instrument Set for Bariatric Surgery*  
*modular Instruments 10 mm*

*Adipositas-Instrumenten-Set*  
*modulare Instrumente 10 mm*

Innenteil / <i>Jaw insert</i> 	Schaffrohr, unisoliert <i>Sheath tube, uninsulated</i> 	Griffvarianten / <i>Handle type</i> 		Komplet-Instrument • Innenteil • Schaffrohr • Handgriff  Complete instrument • <i>Jaw insert</i> • <i>Sheath tube</i> • <i>Handle</i>
		mit Sperre, ohne HF-Anschluss <i>with locking mechanism                      without HF connector</i>	mit Sperre, ohne HF-Anschluss <i>with locking mechanism                      without HF connector</i>	
	NL / WL 380 mm	83930072	83930082	Typen / Types
 <b>Manipulator für Gastric Banding</b> 90° abwinkelbarer, atraumatischer Dissektor, Branche mit distalem Langloch und Haken <b>Manipulator for Gastric Banding</b> 90° articulable, atraumatic dissector, branch with distal slot and hook	8397.654	●	●	<b>83976547</b>
 <b>Stapler-Kopf-Greifzange</b> 30° abgewinkelt, doppelbeweglich <b>Stapler-head-grasping forceps</b> 30° angled, double-action	8397.655	●	●	<b>83976558</b>

\* JL = Jaw length when jaws closed (approximate measurements)



\* MTL = Maulteillänge bei geschlossenem Maulteil (gerundete Angaben)

*Instrument Set for Bariatric Surgery*

*Electrode, monopolar, 5 mm*

**Adipositas-Instrumenten-Set**

Elektrode, monopolar, 5 mm







		
	NL / WL	Typen / Type
 <b>Haken-Elektrode</b> <i>Hook electrode</i>	420 mm	<b>8384.423</b>

## Instrument Set for Bariatric Surgery

Needle Holder 5 mm  
modular system

## Adipositas-Instrumenten-Set

Nadelhalter 5 mm  
modulares System

<p>Innenteil mit Schaffrohr und Spülanschluss Inner section with sheath tube and irrigation tap</p> 				<p>Axialer Handgriff / Axial handle</p>  <ul style="list-style-type: none"> <li>• einseitig beweglich</li> <li>• ausschaltbare Rastsicherung</li> <li>• one jaw opening</li> <li>• locking mechanism can be disabled</li> </ul>	<p><b>Komplett-Instrument</b></p> <ul style="list-style-type: none"> <li>• Innenteil mit Schaffrohr</li> <li>• Griff</li> </ul> <p><b>Complete instrument</b></p> <ul style="list-style-type: none"> <li>• Inner section with sheath tube</li> <li>• Handle</li> </ul>
	Typen / Types	Ø	NL / WL	8393.941	Typen / Types
 <p><b>Modularer Nadelhalter</b>, gerade mit Hartmetalleinsatz <b>Modular needle holder</b>, straight with carbide insert</p>	8393.505	5 mm	310 mm	●	<b>8393.502</b>
	8394.505	5 mm	430 mm	●	<b>8394.502</b>
 <p><b>Modularer Nadelhalter</b>, rechts gebogen mit Hartmetalleinsatz <b>Modular needle holder</b>, curved right with carbide insert</p>	8393.514	5 mm	310 mm	●	<b>8393.511</b>
	8394.514	5 mm	430 mm	●	<b>8394.511</b>
 <p><b>Modularer Nadelhalter</b>, links gebogen mit Hartmetalleinsatz <b>Modular needle holder</b>, curved left with carbide insert</p>	8393.515	5 mm	310 mm	●	<b>8393.512</b>
	8394.515	5 mm	430 mm	●	<b>8394.512</b>
 <p><b>Modularer Multifunktions*-Nadelhalter nach Sarbu</b> <b>Modular multifunction* needle holder by Sarbu</b></p>	8393.506	5 mm	310 mm	●	<b>8393.503</b>
	8394.506	5 mm	430 mm	●	<b>8394.503</b>

\* with automatic needle alignment mechanism and cutting edge

\* mit automatischer Nadelaufstellvorrichtung und Schneidkante













## Instrument Set for Bariatric Surge

**ERAGON** modular Knot Pusher 5 mm

## Adipositas-Instrumenten-Set

**ERAGON** modular Knotenschieber 5 mm

 <p>Alle Maulteile und Schaffrohre sind ebenfalls mit <b>ERAGONaxial</b> kombinierbar. All jaw inserts and sheaths can also be combined with <b>ERAGONaxial</b>.</p>	Griffvarianten / Handle type				<p>Drehradaufsatz, <b>ERAGONaxial</b> Knob attachment, <b>ERAGONaxial</b></p>  <p>autoklavierbar / autoclavable</p>
	 <p>mit Sperre, drehbar with locking mechanism, rotatable</p>	 <p>HF / mono ohne Sperre, drehbar without locking mechanism, rotatable</p>	 <p>HF / mono mit Sperre, drehbar with locking mechanism, rotatable</p>	 <p>mit Sperre, nicht drehbar with locking mechanism, not rotatable</p>	
	83930082	83930083	83930084	83930085	8988

<p>Innenteil / Jaw insert</p>  <p>MTL / JL*</p>	<p>Schaffrohr, isoliert Sheath tube, insulated</p> 		<p>Griffvarianten / Handle type</p>  <p>mit Sperre, drehbar with locking mechanism, rotatable</p>	<p><b>Komplett-Instrument</b></p> <ul style="list-style-type: none"> <li>• Innenteil</li> <li>• Schaffrohr</li> <li>• Handgriff</li> </ul> <p><b>Complete instrument</b></p> <ul style="list-style-type: none"> <li>• Jaw insert</li> <li>• Sheath tube</li> <li>• Handle</li> </ul>	
	<p>Typen / Types</p>	<p>NL / WL 330 mm</p>			<p>NL / WL 450 mm</p>
	8393.345	●	●	●	<b>83933457</b>
<p>Extrakorporaler Knotenschieber, mit distaler Aussparung, doppelbeweglich, MTL= 17 mm Extracorporeal knot pusher, with distal fork, double jaw action, MTL= 17 mm</p>	8394345		●	●	<b>83943457</b>

\* JL = Jaw length when jaws closed (approximate measurements)

\* MTL = Maulteillänge bei geschlossenem Maulteil (gerundete Angaben)

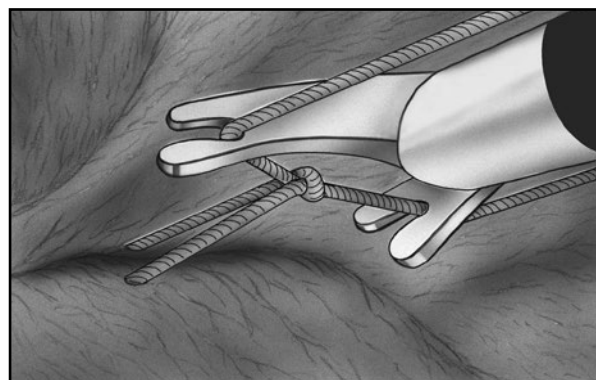

Extrakorporale Knotentechnik  
Extracorporeal knotting technique

**Single Port Surgery**  
**Laparoscope Telescopes 5.3 mm**  
 ‡ distortion-free, long version

**Single-Port Chirurgie**  
**Laparoskop-Optiken 5,3 mm**  
 ‡ verzeichnungsfrei, lange Ausführung

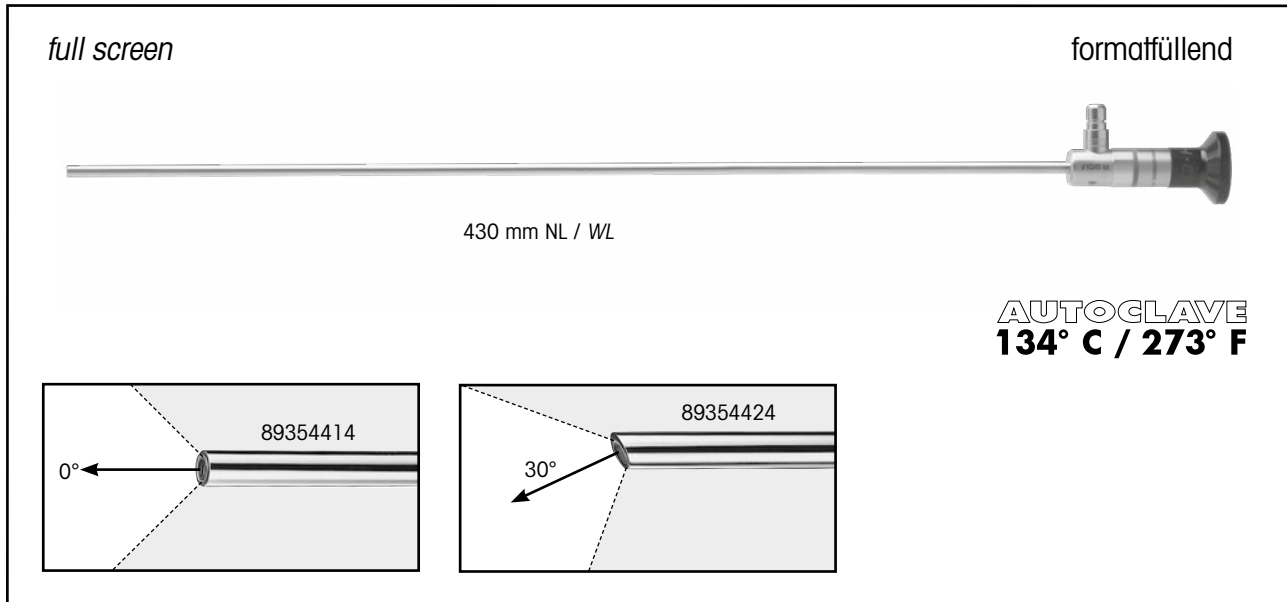

**PANOVIEW telescope, Ø 5.3 mm,**  
**distortion-free, full screen,**

0° .....	89354414
30° .....	89354424

**PANOVIEW Optik, Ø 5,3 mm,**  
**verzeichnungsfrei, formatfüllend**

0° .....	89354414
30° .....	89354424

14

**Recommended light cable:**

**Fiber light cable set** Ø 3.5 mm, 2.3 m long consisting of:  
 Fiber light cable (80663523), adapter projector side (8095.07) and  
 adapter endoscope side (809509)..... 806635231  
 (for maximum light transmission)

**Recommended light cable**  
 for Single Port Surgery (KeyPort):

**Fiber light cable**, 2.3 m long  
 angled 90° distally ..... 8062.351  
 (for maximum light transmission)

**Accessories:**

**Reprocessing basket**  
 (L x W x H) 471 x 59 x 54 mm ..... 38021.111

**Empfohlene Lichtleiter:**

**Fiber Lichtleiter Set**, Ø 3,5 mm, 2,3 m lang bestehend aus:  
 Fiber Lichtleiter (80663523), Adapter projektorseitig (8095.07) und  
 Adapter endoskopseitig (809509)..... 806635231  
 (für maximale Lichttransmission)

**Empfohlene Lichtleiter**  
 für die Single-Port Chirurgie (KeyPort):

**Fiber-Lichtleiter**, 2,3 m lang  
 distal 90° abgewinkelt..... 8062.351  
 (für maximale Lichttransmission)

**Zubehör:**

**Aufbereitungskorb**  
 (L x B x H) 471 x 59 x 54 mm ..... 38021.111

**Single Port Surgery**  
**Laparoscope Telescopes 5.7 mm**  
 ‡ distortion-free, long version

**Single-Port Chirurgie**  
**Laparoskop-Optiken 5,7 mm**  
 ‡ verzeichnungsfrei, lange Ausführung

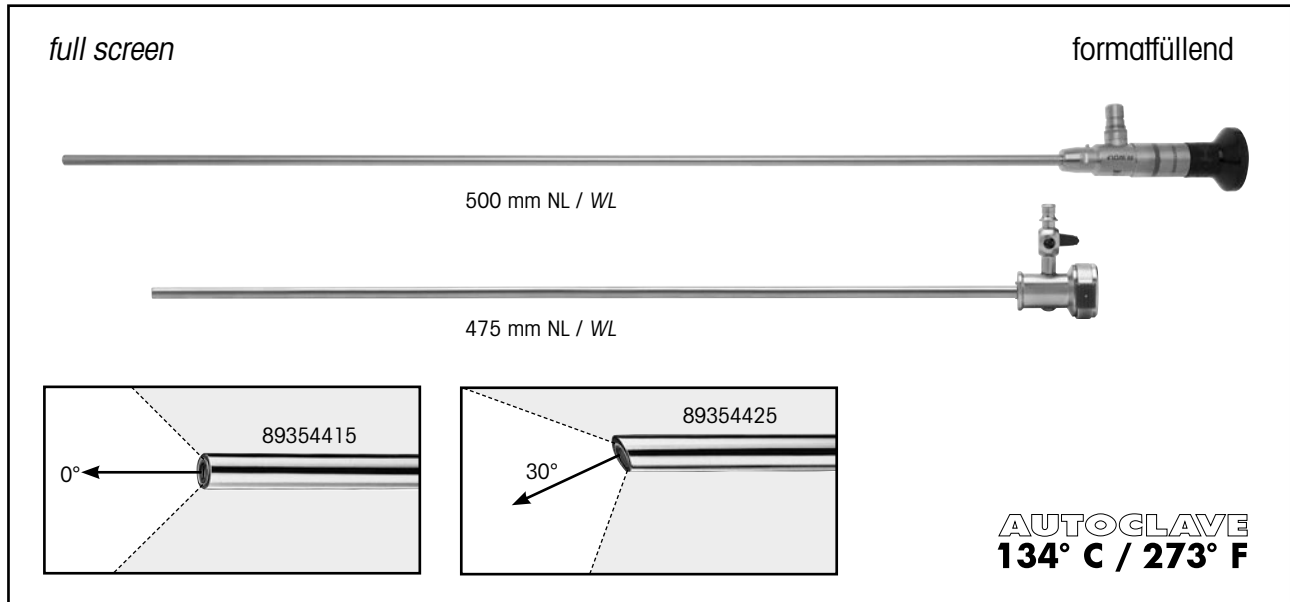

**PANOVIEW telescope, Ø 5.7 mm,**  
**distortion-free, full screen,**

0° .....	89354415
30° .....	89354425

also:

**Rinsing sheath for PANOVIEW telescope**

for PANOVIEW Telescope 89354425, rinsing sheath WL 475mm, Ø 7mm .....	893544255
--	-----------

Recommended light cable:

**Fiber light cable set**, Ø 5.0 mm, 2.3 m long consisting of:  
 Fiber light cable (80665023), adapter projector side (8095.07) and  
 adapter endoscope side (809509) ..... 806650231  
 (for maximum light transmission)

**Fiber light cable set Fusion**, high-temperature resistant,  
 Ø 5.0 mm, 2.3 m long consisting of:  
 Fiber light cable (80655023), adapter projector side (8095.07) and  
 adapter endoscope side (809509) ..... 806550231  
 (for maximum light transmission)

Recommended light cable  
 for Single Port Surgery (KeyPort):

<b>Fiber light cable</b> , 2.3 m long .....	8062.451
---	----------

(for maximum light transmission)

Accessories:

**Reprocessing basket**

(L x W x H) 610 x 59 x 54 mm .....	38022.111
------------------------------------	-----------

**PANOVIEW Optik, Ø 5,7 mm,**  
**verzeichnungsfrei, formattfüllend**

0° .....	89354415
30° .....	89354425

hierzu:

**Spülschaft für PANOVIEW Optik**

für PANOVIEW Optik 89354425, Spülschaft NL 475 mm, Ø 7 mm .....	893544255
--	-----------

Empfohlene Lichtleiter:

**Fiber Lichtleiter Set**, Ø 5,0 mm, 2,3 m lang bestehend aus:  
 Fiber Lichtleiter (80665023), Adapter projektorseitig (8095.07) und  
 Adapter endoskopseitig (809509) ..... 806650231  
 (für maximale Lichttransmission)

**Fiber Lichtleiter Set Fusion**, hochtemperaturbeständig,  
 Ø 5,0 mm, 2,3 m lang bestehend aus:  
 Fiber Lichtleiter (80655023), Adapter projektorseitig (8095.07) und  
 Adapter endoskopseitig (809509) ..... 806550231  
 (für maximale Lichttransmission)

Empfohlene Lichtleiter  
 für die Single-Port Chirurgie (KeyPort):

<b>Fiber-Lichtleiter</b> , 2,3 m lang .....	8062.451
---	----------

(für maximale Lichttransmission)









Zubehör:

**Aufbereitungskorb**

(L x B x H) 610 x 59 x 54 mm .....	38022.111
------------------------------------	-----------

**KeyPort<sup>flex</sup>**  
Single Port System  
transabdominal

**KeyPort<sup>flex</sup>**  
Single-Port System  
transabdominell

		
		Type / Type
<p><b>KeyPort flex Aufnahmeteil</b> autoklavierbar, DL 30 mm, Schnittstelle für Dichteinsatz 8850243/8850244/8850245 und KeyPort flex Silikon-Tubus 485061</p> <p><b>KeyPort flex adapter</b> autoclavable, inner lumen 30 mm, interface for KeyPort silicone sealings 8850243/ 8850244/8850245 and KeyPort flex silicone tube 485061</p>	 	<b>885060</b>
<p><b>KeyPort flex Silikon-Tubus, steril</b> (VE=10 ST), Arbeitslänge: 55 mm, Ø 33 mm, zur Adaption an KeyPort flex, Aufnahmeteil 885060</p> <p><b>KeyPort flex silicone tube, sterile</b> (PACK=10 PCS), working length: 55 mm, Ø 33 mm, for connection to KeyPort flex adapter 885060</p>	 	<b>485061</b>
<p><b>KeyPort Silikon-Dichteinsatz 2 Luer</b> (VE= 3 ST), autoklavierbar, mit drei Ventilzugängen, mit 2 Luerlock-Anschlüssen zur CO<sub>2</sub>-Insufflation und Rauchgas-Absaugung, Schnittstelle für KeyPort flex Aufnahmeteil 885060</p> <p><b>KeyPort silicone sealing insert, 2 luer lock</b> (PACK=3 PCS), autoclavable, with three valve ports, with 2 luer-lock connectors for CO<sub>2</sub> insufflation and active or passive smoke-evacuation, interface for KeyPort flex adapter 885060</p>	 	<b>8850244</b>
<p><b>KeyPort flex komplett</b> bestehend aus: KeyPort flex Aufnahmeteil (885060), KeyPort flex Silikon-Tubus (VE= 10 ST, 485061), KeyPort Silikon-Dichteinsatz 2 Luer lock (VE= 3 ST, 8850244), Adapter für Dichtungskappe 8931 (885015), Adapter für Dichtungskappe 89.08 (885010), Adapter für Dichtungskappe 8902 (885005), Hülse für Dichtungskappe 89.08 (8850010), Hülse für Dichtungskappe 89.02 (8850005), Hülse für Dichtungskappe 89.04 (8850007), Dichtungskappe (VE= 10 ST, 89.04), Dichtungskappe (VE= 10 ST, 8932), Dichtungskappe (VE= 10 ST, 8930), Dichtungskappe (VE= 10 ST, 8931), Dichtungskappe (VE= 10 ST, 89.08), Dichtungskappe (VE= 10 ST, 89.02), Zweiwegehahn (8850501)</p> <p><b>KeyPort flex bundle</b> consisting of: KeyPort flex adapter (885060), KeyPort flex silicone tube (PACK=10 PCS, 485061), KeyPort silicone sealing insert 2 luer lock (PACK=3 PCS, 8850244), adapter for sealing cap 8931 (885015), adapter for sealing cap 89.08 (885010), adapter for sealing cap 89.02 (885005), sleeve for sealing cap 89.08 (8850010), sleeve for sealing cap 8902 (8850005), sleeve for sealing cap 89.04 (8850007), sealing cap (PACK=10 PCS, 89.04), sealing cap (PACK=10 PCS, 8932), sealing cap (PACK=10 PCS, 8930), sealing cap (PACK=10 PCS, 8931), sealing cap (PACK=10 PCS, 89.08), sealing cap (PACK=10 PCS, 89.02), Two-way stopcock (885001)</p>		<b>8850601</b>

**KeyPort<sup>flex</sup>**  
Single Port System  
transabdominal



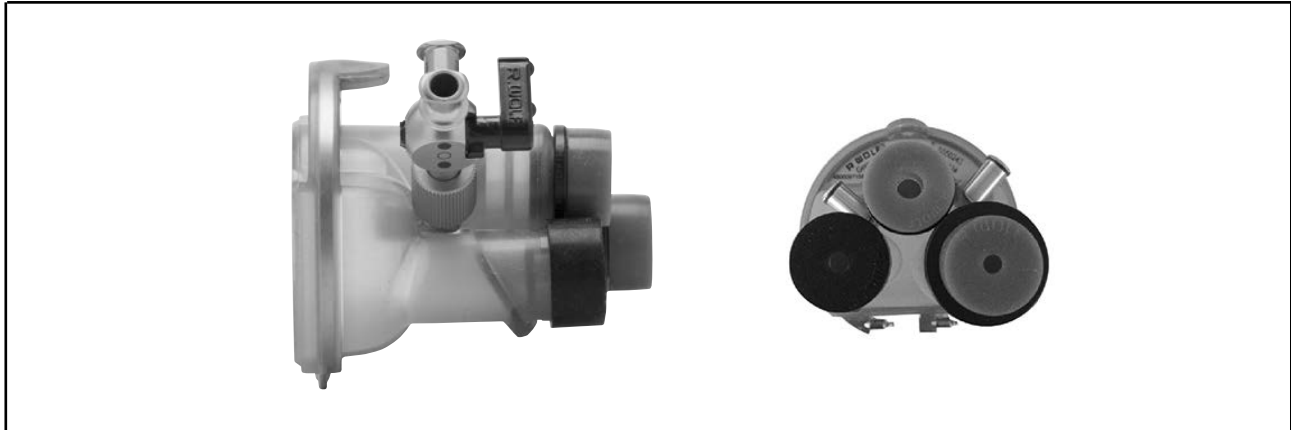



**KeyPort<sup>flex</sup>**  
Single-Port System  
transabdominell



		Type / Type
<p><b>KeyPort Silikon Dichteinsatz kpl</b> bestehend aus: KeyPort Silikon-Dichteinsatz 2 Luer (VE= 3 ST, 8850244), Adapter für Dichtungskappe 8931 (885015), Adapter für Dichtungskappe 89.08 (885010), Adapter für Dichtungskappe 89.02 (885005), Hülse für Dichtungskappe 89.08 (8850010), Hülse für Dichtungskappe 89.02 (8850005), Hülse für Dichtungskappe 89.04 (8850007), Dichtungskappe (VE= 10 ST, 89.04), Dichtungskappe (VE= 10 ST, 8932), Dichtungskappe (VE= 10 ST, 8930), Dichtungskappe (VE= 10 ST, 8931), Dichtungskappe (VE= 10 ST, 89.08), Dichtungskappe (VE= 10 ST, 89.02), Zweiwegehahn (8850501)</p> <p><b>KeyPort silicone sealing insert bndl</b> consisting of: KeyPort silicone sealing insert 2 luer (PACK=3 PCS, 8850244), adapter for sealing cap 8931 (885015), adapter for sealing cap 89.08 (885010), adapter for sealing cap 89.02 (885005), sleeve for sealing cap 89.08 (8850010), sleeve for sealing cap 8902 (8850005), sleeve for sealing cap 89.04 (8850007), sealing cap (PACK=10 PCS, 89.04), sealing cap (PACK=10 PCS, 8932), sealing cap (PACK=10 PCS, 8930), sealing cap (PACK=10 PCS, 8931), sealing cap (PACK=10 PCS, 89.08), sealing cap (PACK=10 PCS, 89.02), Two-way stopcock (8850501)</p>	<p>Im Dichteinsatz-Set sind alle notwendigen Adapter, Hülsen für Dichtungskappen und Dichtungskappen (10er-Packungen) für die Instrumentendurchmesser von 5 –15 mm enthalten.</p> <p><i>The sealing insert set contains all the necessary adapters, sleeves for sealing cap and sealing caps (packs of 10) for instrument diameters of 5 –15 mm.</i></p>	<p>88502432</p>

**KeyPort<sup>flex</sup>**  
Single Port System  
transanal / TEM

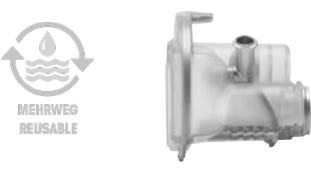
**KeyPort<sup>flex</sup>**  
Single-Port-System  
transanal / TEM

		
		Type / Type
<p><b>KeyPort flex Aufnahmeteil</b> autoklavierbar, DL 30 mm, Schnittstelle für Dichteinsatz 8850243/8850244/8850245 und KeyPort flex Silikon-Tubus 485061 <b>KeyPort flex adapter</b> autoclavable, inner lumen 30 mm, interface for KeyPort silicone sealings 8850243/ 8850244/8850245 and KeyPort flex silicone tube 485061</p>	 <p> MEHRWEG REUSABLE</p>	<b>885060</b>
<p><b>KeyPort flex Silikon-Tubus</b>, steril (VE=10 ST), Arbeitslänge: 55 mm, Ø 33 mm, zur Adaption an KeyPort flex, Aufnahmeteil 885060 <b>KeyPort flex silicone tube</b>, sterile (PACK= 10 PCS), working length: 55 mm, Ø 33 mm, for connection to KeyPort flex adapter 885060</p>	 <p> MEHRWEG REUSABLE</p>	<b>485061</b>
<p><b>KeyPort Silikon-Dichteinsatz TEM</b> (VE= 3 ST) autoklavierbar, mit drei Ventilzugängen, mit 2 Luer lock-Anschlüssen zur CO<sub>2</sub>-Insufflation und Rauchgasausleitung/Absaugung, zusätzlicher Anschluss zur Druckmessung in Verbindung mit der TEM-Kombinationseinheit 22322011, Schnittstelle für KeyPort flex Aufnahmeteil 885060 <b>KeyPort silicone sealing insert, TEM</b> (PACK= 3 PCS) autoclavable, with three valve ports, with 2 luer lock connectors for CO<sub>2</sub> insufflation and active or passive smoke-evacuation, additional connector for pressure measurement in conjunction with the TEM combination unit 22322011 interface for KeyPort flex adapter 885060</p>	 <p> MEHRWEG REUSABLE</p>	<b>8850245</b>
<p><b>KeyPort flex Silikon-Tubus kpl</b> bestehend aus: KeyPort flex Aufnahmeteil (885060), KeyPort flex Silikon-Tubus (VE=10 ST, 485061), KeyPort Silikon-Dichteinsatz TEM (VE=3 ST, 8850245), Adapter für Dichtungskappe 8931 (885015), Adapter für Dichtungskappe 89.08 (885010), Adapter für Dichtungskappe 89.02 (885005), Hülse für Dichtungskappe 89.08 (8850010), Hülse für Dichtungskappe 89.02 (8850005), Hülse für Dichtungskappe 89.04 (8850007), Dichtungskappe (VE=10 ST, 89.04), Dichtungskappe (VE=10 ST, 8932), Dichtungskappe (VE=10 ST, 8930), Dichtungskappe (VE=10 ST, 8931), Dichtungskappe (VE=10 ST, 89.08), Dichtungskappe (VE=10 ST, 89.02) <b>KeyPort flex silicone-tube bndl</b> consisting of: KeyPort flex adapter (885060), KeyPort flex silicone tube (PACK=10 PCS, 485061), KeyPort silicone sealing insert TEM (PACK=3 PCS, 8850245), adapter for sealing cap 8931 (885015), adapter for sealing cap 89.08 (885010), adapter for sealing cap 89.02 (885005), sleeve for sealing cap 89.08 (8850010), sleeve for sealing cap 89.02 (8850005), sleeve for sealing cap 89.04 (8850007), sealing cap (PACK=10 PCS, 89.04), sealing cap (PACK=10 PCS, 8932), sealing cap (PACK=10 PCS, 8930), sealing cap (PACK=10 PCS, 8931), sealing cap (PACK=10 PCS, 89.08), sealing cap (PACK=10 PCS, 89.02)</p>		<b>8850602</b>

14

**KeyPort<sup>flex</sup>**  
Single Port System  
transanal / TEM

**KeyPort<sup>flex</sup>**  
Single-Port System  
transanal / TEM

		Type / Type
<p><b>KeyPort Silikon Dichteinsatz kpl</b> bestehend aus: KeyPort Silikon-Dichteinsatz 2 Luer lock (VE = 3 ST, 8850244), Adapter für Dichtungskappe 8931 (885015), Adapter für Dichtungskappe 89.08 (885010), Adapter für Dichtungskappe 89.02 (885005), Hülse für Dichtungskappe 89.08 (8850010), Hülse für Dichtungskappe 89.02 (8850005), Hülse für Dichtungskappe 89.04 (8850007), Dichtungskappe (VE= 10 ST, 89.04), Dichtungskappe (VE= 10 ST, 8932), Dichtungskappe (VE= 10 ST, 8930), Dichtungskappe (VE= 10 ST, 8931), Dichtungskappe (VE= 10 ST, 89.08), Dichtungskappe (VE= 10 ST, 89.02), Zweiwegehahn (8850501)</p> <p><b>KeyPort silicone sealing insert bndl</b> consisting of: KeyPort silicone sealing insert 2 luer (PACK=3 PCS, 8850244), adapter for sealing cap 8931 (885015), adapter for sealing cap 89.08 (885010), adapter for sealing cap 89.02 (885005), sleeve for sealing cap 89.08 (8850010), sleeve for sealing cap 8902 (8850005), sleeve for sealing cap 89.04 (8850007), sealing cap (PACK=10 PCS, 89.04), sealing cap (PACK=10 PCS, 8932), sealing cap (PACK=10 PCS, 8930), sealing cap (PACK=10 PCS, 8931), sealing cap (PACK=10 PCS, 89.08), sealing cap (PACK=10 PCS, 89.02), Two-way stopcock (8850501)</p>	<p>Im Dichteinsatz-Set sind alle notwendigen Adapter, Hülsen für Dichtungskappen und Dichtungskappen (10er-Packungen) für die Instrumentendurchmesser von 5 –15 mm enthalten.</p> <p><i>The sealing insert set contains all the necessary adapters, sleeves for sealing cap and sealing caps (packs of 10) for instrument diameters of 5 –15 mm.</i></p>	<p><b>88502432</b></p>



**KeyPort**  
Single Port System reusable  
transabdominal

**KeyPort**  
Single-Port System wiederverwendbar  
transabdominell



		Type / Type
<p><b>KeyPort Trocarhülse</b>, autoklavierbar, trianguläre Ausformung mit Durchlass 21 mm, NL 30 mm, mit Gewindevankerung, Schnittstelle für Haltearm (Endo-Motion Haltearm 37500.001 und U-Förmiger Haltearm 8840.9721) und Fixiermöglichkeit für Fasziennaht, Schnittstelle für Silikon- Dichteinsatz (8850243)</p> <p><b>KeyPort trocar sleeve</b>, autoclavable, triangular shape with 21 mm passage, WL 30 mm, with thread anchor, interface for retainer arm (Endo-Motion retainer arm 37500.001 and U-shaped retainer arm 8840.9721) and fixing option for fascia thread, interface for silicone seal insert (8850243)</p>		<p><b>885020</b></p>
<p><b>KeyPort Trokar</b>, autoklavierbar, kegelig-stumpf, mit zentraler Bohrung zur Primärsufflation, für Single-Port Trocarhülse</p> <p><b>KeyPort trocar</b>, autoclavable, conical blunt shape, with central bore for primary insufflation, for Single Port trocar sleeve</p>		<p><b>885021</b></p>

14

<p><b>KeyPort Trocarhülse</b>, autoklavierbar, trianguläre Ausformung mit Durchlass 24 mm, NL 36 mm, mit Gewindevankerung, Schnittstelle für Haltearm (Endo-Motion Haltearm 37500.001 und U-Förmiger Haltearm 8840.9721) und Fixiermöglich keit für Fasziennaht, Schnittstelle für Silikon -Dichteinsatz (8850243)</p> <p><b>KeyPort trocar sleeve</b>, autoclavable, triangular shape with 24 mm passage, WL 36 mm, with thread anchor, interface for retainer arm (Endo-Motion retainer arm 37500.001 and U-shaped retainer arm 8840.9721) and fixing option for fascia thread, interface for silicone seal insert (8850243)</p>		<p><b>885030</b></p>
<p><b>KeyPort Trokar</b>, autoklavierbar, kegelig-stumpf, mit zentraler Bohrung zur Primärsufflation, für Single-Port Trocarhülse</p> <p><b>KeyPort trocar</b>, autoclavable, conical blunt shape, with central bore for primary insufflation, for Single Port trocar sleeve</p>		<p><b>885031</b></p>



**KeyPort**  
Single Port System reusable  
transabdominal

**KeyPort**  
Single-Port System wiederverwendbar  
transabdominell











		Type / Type
<p><b>KeyPort SILIKON Dichteinsatz kpl</b> bestehend aus: <b>KeyPort</b> Silikon-Dichteinsatz (VE= 3 ST, 8850243), Adapter für Dichtungskappe 89.02 (885005), Adapter für Dichtungskappe 89.08 (885010), Adapter für Dichtungskappe 8931 (885015), Hülse für Dichtungskappe 89.02 (8850005), Hülse für Dichtungskappe 89.08 (8850010), Dichtungskappe (VE= 10 ST, 89.02), Dichtungskappe (VE= 10 ST, 89.08), Dichtungskappe (VE= 10 ST, 89.10), Dichtungskappe (VE= 10 ST, 8930), Dichtungskappe (VE= 10 ST, 8931), Dichtungskappe (VE= 10 ST, 8932) Zweiwegehahn (8850501)</p> <p><b>KeyPort silicone seal insert bndl</b> comprising: <b>KeyPort</b> silicone seal insert (PACK=3 PCS, 8850243), adapter for sealing cap 89.02 (885005), adapter for sealing cap 89.08 (885010), adapter for sealing cap 8931 (885015), sleeve for sealing cap 89.08 (8850010), sealing cap (PACK=10 PCS, 89.02), sealing cap (PACK=10 PCS, 89.08), sealing cap (PACK=10 PCS, 89.10), sealing cap (PACK=10 PCS, 8930), sealing cap (PACK=10 PCS, 8931), sealing cap (PACK=10 PCS, 8932), two-way stopcock (8850501)</p>	<p>Im Dichteinsatz-Set sind alle notwendigen Adapter, Hülsen für Dichtungskappen und Dichtungskappen (10er-Packungen) für die Instrumentendurchmesser von 5 –15 mm enthalten.</p> <p><i>The sealing insert set contains all the necessary adapters, sleeves for sealing cap and sealing caps (packs of 10) for instrument diameters of 5 –15 mm.</i></p>	<p><b>88502431</b></p>

*DuoRotate / InLine Instruments*  
monopolar

DuoRotate / InLine Instrumente  
monopolar









Innenteil, isoliert <i>Jaw insert, insulated</i>	DuoRotate Schaffrohr / Sheath tube	InLine Schaffrohr / Sheath tube	Griffvarianten Handle type		<b>Komplett-Instrument</b> <ul style="list-style-type: none"> <li>• Innenteil</li> <li>• Schaffrohr</li> <li>• Griff</li> <li>• Spüladapter (8399300)</li> </ul> <b>Complete instrument</b> <ul style="list-style-type: none"> <li>• Jaw insert</li> <li>• Sheath tube</li> <li>• Handle</li> <li>• Rinsing adapter (8399300)</li> </ul>	
 Typen / Types	 Ø 5.8 mm NL / WL 400 mm Typen / Types	 Ø 5.8 mm NL / WL 400 mm Typen / Types	 DuoRotate Handgriff DuoRotate handle Typen / Types	 InLine Handgriff InLine handle Typen / Types		
 DuoRotate / InLine "Mixer", MTL= 21 mm DuoRotate / InLine "Mixer", JL= 21 mm	8399410	8399310	8399311	8399301	8399302	Typen / Types 83993010 83994010
 DuoRotate / InLine "Maryland", MTL= 19 mm DuoRotate / InLine "Maryland", JL= 19 mm	8399412	8399310	8399311	8399301	8399302	Typen / Types 83993012 83994012
 DuoRotate / InLine "Metzenbaum", MTL= 18 mm DuoRotate / InLine "Metzenbaum", JL= 18 mm	8399413	8399310	8399311	8399301	8399302	Typen / Types 83993013 83994013
 DuoRotate / InLine "Fasszange", MTL= 17 mm DuoRotate / InLine "Grasping forceps", JL= 17 mm	8399414	8399310	8399311	8399301	8399302	Typen / Types 83993011 83994011

\* JL = Jaw length when jaws closed (approximate measurements)  
HF connecting cable see page BDE 163.

\* MTL = Maulteillänge bei geschlossenem Maulteil (gerundete Angaben)  
HF-Anschlusskabel siehe Blatt BDE 163.

*DuoRotate / InLine Instruments*  
*monopolar*

*DuoRotate / InLine Instrumente*  
*monopolar*

					
Innenteil, isoliert <i>Jaw insert, insulated</i>	DuoRotate Schaftrohr / <i>Sheath tube</i>	InLine Schaftrohr / <i>Sheath tube</i>	Griffvarianten <i>Handle type</i>		<b>Komplett- Instrument</b> • Innenteil • Schaftrohr • Griff
	 Ø 5.8 mm NL / WL 400 mm	 Ø 5.8 mm NL / WL 400 mm			<b>Complete instrument</b> • <i>Jaw insert</i> • <i>Sheath tube</i> • <i>Handle</i>
	Typen / Types	8399310	8399311	DuoRotate Handgriff <i>DuoRotate handle</i> 8399301	InLine Handgriff <i>InLine handle</i> 8399302
 <b>DuoRotate / InLine "Darmfasszange"</b> , MTL= 23 mm <b>DuoRotate / InLine "Intestine grasping forceps"</b> , JL= 23 mm	8399415	●	●	●	●
			●	●	●
			●	●	●
			●	●	●

\* JL = Jaw length when jaws closed (approximate measurements)

\* MTL = Maulteillänge bei geschlossenem Maulteil (gerundete Angaben)

hierzu / also:		Type / Type
<b>Spüladapter</b> <i>Rinsing adapter</i>		<b>8399300</b>





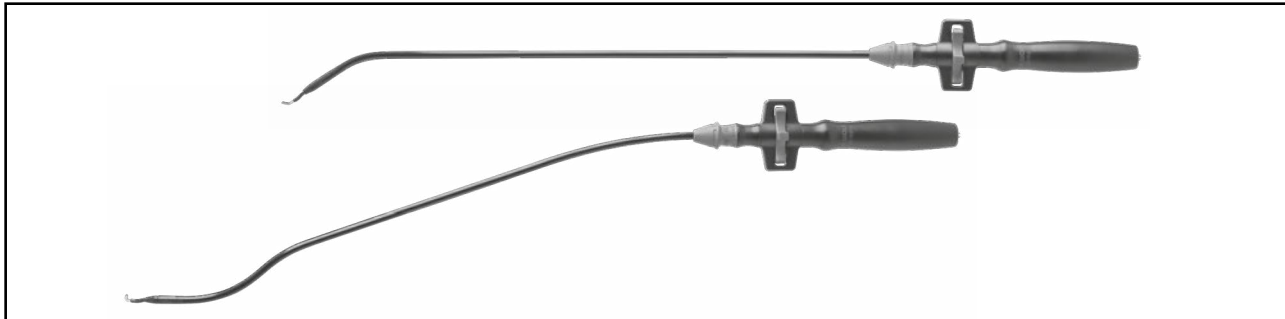

HF connecting cable see page BDE 163.

HF-Anschlusskabel siehe Blatt BDE 163.

*DuoRotate / InLine Hook Electrodes*  
monopolar

*DuoRotate / InLine Hakenelektroden*  
monopolar





Innenteil, isoliert <i>Jaw insert, insulated</i>	DuoRotate Schaftrohr / <i>Sheath tube</i>	InLine Schaftrohr / <i>Sheath tube</i>	Griffvarianten <i>Handle type</i>	<b>Komplett- Instrument</b>	
				<ul style="list-style-type: none"> <li>• Innenteil</li> <li>• Schaftrohr</li> <li>• Griff</li> </ul> <b>Complete instrument</b> <ul style="list-style-type: none"> <li>• <i>Jaw insert</i></li> <li>• <i>Sheath tube</i></li> <li>• <i>Handle</i></li> </ul>	
	Ø 5.8 mm NL / WL 400 mm	Ø 5.8 mm NL / WL 400 mm	DuoRotate / InLine Elektroden-Handgriff / <i>electrode handle</i>		
	Typen / Types	8399310	8399311	8399303	Typen / Types
	8399416	•		•	<b>83993016</b>
DuoRotate / InLine "Hakenelektrode 90°" DuoRotate / InLine "Hook electrode 90°"			•	•	<b>83994016</b>
	8399417	•		•	<b>83993017</b>
DuoRotate / InLine "Hakenelektrode 45°" DuoRotate / InLine "Hook electrode 45°"			•	•	<b>83994017</b>

hierzu / also:		Type / Type
Spüladapter <i>Rinsing adapter</i>		<b>8399300</b>

*HF Suction and Irrigation Tube 5.4 mm  
monopolar, curved*

*HF-Saug-Spülrohr 5,4 mm  
monopolar, gebogen*

			
	Ø 5.4 mm	NL / WL 380 mm	Typen/ Type
	●	●	<b>8383814</b>
<p><i>HF-Saug-Spül-Rohr, gebogen</i> <i>HF Suction-irrigation tube, curved</i></p>			

also:

hierzu:



*Suction-irrigation handle* ..... 8385.901  
*Sealing cap* ..... 8385.902  
**Required to use Ø 5 mm auxiliary instruments:**  
*Sealing attachment with opening  
and membrane valve* ..... 8385.903  
*Spare membrane valve* ..... 89.103

**Saug-Spül-Handgriff**..... 8385.901  
**Verschlusskappe** ..... 8385.902  
**Notwendig bei der Anwendung von Hilfsinstrumenten Ø 5 mm:**  
**Dichtaufsatz mit Durchgang  
und Membranventil** ..... 8385.903  
**Ersatz-Membran-Ventil** ..... 89.103

HF connecting cable see page BDE 163.

HF-Anschlusskabel siehe Blatt BDE 163 .

# INSUFFLATOR Highflow 45 BASIC

# INSUFFLATOR Highflow 45 BASIC



- 6.5" Color display
- Touchscreen
- Max. flow rate 45 l / min
- Functional and user-friendly design
- Optional configurable software modules

- 6,5" Farbdisplay
- Touchscreen
- Max. Flowrate 45 l / min
- Funktionelles und anwenderfreundliches Design
- Optional konfigurierbare Software-Module

### INSUFFLATOR Highflow 45 BASIC Set

consisting of:

INSUFFLATOR Highflow 45 Basic (2235001),  
insufflation tube, Ø 5 mm, 2.5 m long (8170.101),  
hygiene filter, sterile PACK=10 PCS (4171.111),  
power cable 3 m long (2440.03) ..... 22350011

### INSUFFLATOR Highflow 45 BASIC Set

bestehend aus:

INSUFFLATOR Highflow 45 Basic (2235001),  
Insufflationsschlauch, Ø 5 mm, 2,5 m lang (8170.101),  
Hygiene-Filter, VE=10 ST, steril verpackt (4171.111),  
Netz Kabel 3 m lang (2440.03) ..... 22350011

Necessary accessories:

#### CO<sub>2</sub> pressure tube

length 1.5 m ..... 74021.029  
with

#### Pressure reducer CO<sub>2</sub>

DIN 477-1 ..... 74007.054  
DIN EN ISO 407 ..... 74007.055  
ISO 5145 ..... 74007.056

or

#### Connecting tube, 5 m long

for central CO<sub>2</sub> gas supply (Dräger) ..... 74021.030

#### Connecting tube, 5 m long

for central CO<sub>2</sub> gas supply (Air Liquide) ..... 74021035

Optional accessories:

#### Insufflation tube, disposable

with integrated hygiene filter,  
PACK=10 PCS, in individual sterile packs ..... 4170.501

#### High-flow insufflation tube\*,

Ø 8 mm, autoclavable ..... 8170.232

\*recommended in conjunction with high-flow trocar sleeves

Erforderliches Zubehör:

#### CO<sub>2</sub>-Druckschlauch

Länge 1,5 m ..... 74021.029  
mit

#### Druckminderer CO<sub>2</sub>

DIN 477-1 ..... 74007.054  
DIN EN ISO 407 ..... 74007.055  
ISO 5145 ..... 74007.056

oder

#### Verbindungsschlauch, 5 m lang,

für zentrale CO<sub>2</sub>-Gasversorgung (Dräger) ..... 74021.030

#### Verbindungsschlauch, 5 m lang,

für zentrale CO<sub>2</sub>-Gasversorgung (Air Liquide) ..... 74021035

Optionales Zubehör:

#### Insufflationsschlauch, zum Einmalgebrauch

mit integrierem Hygienefilter,  
VE=10 ST, einzeln steril verpackt ..... 4170.501

#### High-Flow-Insufflationsschlauch\*,

Ø 8 mm, autoklavierbar ..... 8170.232

\*in Verbindung mit High-Flow-Trocarhülsen empfohlen

Optional software module:

Software module CAN-BUS, integrated core ..... 2235101

Software module BABY-MODE ..... 2235102

Software module VIDEO-DISPLAY ..... 2235103

Optionale Software-Module:

Softwaremodul CAN-BUS, Integration in core ..... 2235101

Softwaremodul BABY-MODE ..... 2235102

Softwaremodul VIDEOEINBLENDUNG ..... 2235103

## INSUFFLATOR

### Highflow 45 BASIC

#### Technical data

## INSUFFLATOR

### Highflow 45 BASIC

#### Technische Daten

Schutzklasse nach IEC / EN 60601-1 ; (UL 60601-1 / CSA C22.2 No.601.1 - für USA) <i>Protection class complying with IEC / EN 60601-1 ; (UL 60601-1 / CSA C22.2 No.601.1 - for USA)</i>	1
Elektromagnetische Verträglichkeit (EMV) <i>Electromagnetic compatibility (EMC)</i>	gemäß IEC / EN 60601-1-2 <i>according to EN 60601-1-2</i>
Richtlinie über Medizinprodukte 93/42/EWG <i>Medical Device Directive 93/42/EEC</i>	Klasse IIb <i>Class IIb</i>
Schutz gegen elektrischen Schlag <i>Protection against electric shock</i>	Anwendungsteil des Typs CF <i>Application part of Type CF</i>
Schutzgrad gegen Eindringen von Flüssigkeit <i>Degree of protection against penetration of liquids</i>	IP 20 (nicht geschützt) <i>IP 20 (not protected)</i>
Betriebsart <i>Duty cycle</i>	Dauerbetrieb <i>Continuous operation</i>
Schutzgrad bei Anwendung in Gegenwart von brennbaren Gemischen <i>Degree of protection when flammable mixtures are present</i>	Gerät ist nicht explosionsgeschützt (Gerät nicht in zündfähiger Atmosphäre betreiben) <i>This device is not protected against explosions (Do not operate this device in areas where explosive substances are present)</i>
Gewicht <i>Weight</i>	8,9 kg (19,5 lbs) <i>8.9 kg (19.5 lbs)</i>
Abmessungen (B x H x T) <i>Dimensions (W x H x D)</i>	300 mm x 160 mm x 455 mm
Spannung <i>Voltage</i>	100 - 240 V~ / a.c.
Frequenz <i>Frequency</i>	50 / 60 Hz
Leistungsaufnahme <i>Power consumption</i>	60 VA
Sicherung <i>Fuse</i>	T 3,15 H <i>T 3.15 H</i>
Stromaufnahme <i>Power rating</i>	0,6 - 0,2 A <i>0.6 - 0.2 A</i>

#### Relevante Anwendungsparameter / Relevant application parameters:

Insufflationsmedium <i>Insufflation medium</i>	med. CO <sub>2</sub> (Reinheitsgrad > 99,5 %) <i>med. CO<sub>2</sub> (purity &gt; 99,5 %)</i>
Intraabdominalen Druck <i>Intra-abdominal pressure</i>	3 mmHg bis / to 25 mmHg, (± 2 mmHg) vorwählbar / <i>preselectable</i> in 1 mmHg - Schritten / <i>Steps</i>
Gasflussrate: - Primärfüllung - High Flow  <i>Gas flow rate: - primary filling - high flow</i>	1 l/min. (± 50 %) 2 l/min. bis 45 l/min. (± 20 %) vorwählbar in 1 l/min Schritten 1 l/min. 2 l/min. to 45 l/min. (± 20 %) <i>preselectable in 1 l/min steps</i>
Verbrauchsanzeige <i>Consumption display</i>	0 l bis 9999 l (± 20 %) <i>0 l to 9999 l (± 20 %)</i>

# INSUFFLATOR Highflow 45 EVAC

# INSUFFLATOR Highflow 45 EVAC



- 6,5" Color display
- Touchscreen
- Max. flow rate 45 l / min
- Functional and user-friendly design
- Optional configurable software modules
- Smoke gas evacuation

- 6,5" Farbdisplay
- Touchscreen
- Max. Flowrate 45 l / min
- Funktionelles und anwenderfreundliches Design
- Optional konfigurierbare Software-Module
- Rauchgasabsaugung

### Insufflator Highflow 45 EVAC Set

consisting of:

Insufflator Highflow 45 EVAC (2235011),  
insufflation tube, Ø 5 mm, 2.5 m long (8170.101),  
hygiene filter, sterile PACK=10 PCS (4171.111),  
Insufflation tube, disposable with integrated hygiene filter,  
PACK=10 PCS, in individual sterile packs (4170.501)  
disposable tube set for smoke gas evacuation, sterile (PACK=10 PCS)  
(4170503), one-pedal footswitch (20301031) and  
power cable 3 m long (2440.03) ..... 22350111

Necessary accessories:

**CO<sub>2</sub> pressure tube**  
length 1.5 m ..... 74021.029  
with  
**Pressure reducer CO<sub>2</sub>**  
DIN 477-1 ..... 74007.054  
DIN EN ISO 407 ..... 74007.055  
ISO 5145 ..... 74007.056  
or  
**Connecting tube, 5 m long**  
for central CO<sub>2</sub> gas supply (Dräger) ..... 74021.030  
**Connecting tube, 5 m long**  
for central CO<sub>2</sub> gas supply (Air Liquide) ..... 74021035

**Disposable tube set for smoke gas evacuation,**  
sterile (PACK=10 PCS) ..... 4170503

Optional accessories:

**High-flow insufflation tube, Ø 8 mm,**  
autoclavable ..... 8170.232  
**Insufflation tube,**  
disposable with integrated hygiene filter,  
PACK=10 PCS, in individual sterile packs ..... 4170501

Optional software module:

**Software module CAN-BUS, integrated core** ..... 2235101  
**Software module BABY-MODE** ..... 2235102  
**Software module VIDEO-DISPLAY** ..... 2235103

### Insufflator Highflow 45 EVAC Set

bestehend aus:

Insufflator Highflow 45 EVAC (2235011),  
Insufflationsschlauch, Ø 5 mm, 2,5 m lang (8170.101),  
Hygiene-Filter, VE=10 ST, steril verpackt (4171.111),  
Insufflationsschlauch, zum Einmalgebrauch mit integriertem  
Hygienefilter, VE=10 ST, einzeln steril verpackt (4170.501),  
Schlauchset Rauchgasabsaugung steril (4170503),  
Einpedal-Fußschalter (20301031) und  
Netzkabel 3 m lang (2440.03) ..... 22350111

Erforderliches Zubehör:

**CO<sub>2</sub>-Druckschlauch**  
Länge 1,5 m ..... 74021.029  
mit  
**Druckminderer CO<sub>2</sub>**  
DIN 477-1 ..... 74007.054  
DIN EN ISO 407 ..... 74007.055  
ISO 5145 ..... 74007.056  
oder  
**Verbindungsschlauch, 5 m lang,**  
für zentrale CO<sub>2</sub>-Gasversorgung (Dräger) ..... 74021.030  
**Verbindungsschlauch, 5 m lang,**  
für zentrale CO<sub>2</sub>-Gasversorgung (Air Liquide) ..... 74021035

**Einweg-Schlauchset Rauchgasabsaugung,**  
steril ( VE=10 ST) ..... 4170503

Optionales Zubehör:

**High-Flow-Insufflationsschlauch, Ø 8 mm,**  
autoklavierbar ..... 8170.232  
**Insufflationsschlauch**  
zum Einmalgebrauch mit integriertem Hygienefilter,  
(VE=10 ST), einzeln steril verpackt ..... 4170501

Optionale Software-Module:

**Softwaremodul CAN-BUS, Integration in core** ..... 2235101  
**Softwaremodul BABY-MODE** ..... 2235102  
**Softwaremodul VIDEOEINBLENDUNG** ..... 2235103



## INSUFFLATOR

### Highflow 45 EVAC

#### Technical data

## INSUFFLATOR

### Highflow 45 EVAC

#### Technische Daten

Schutzklasse nach IEC / EN 60601-1 ; (UL 60601-1 / CSA C22.2 No.601.1 - für USA) <i>Protection class complying with IEC / EN 60601-1 ; (UL 60601-1 / CSA C22.2 No.601.1 - for USA)</i>	1
Elektromagnetische Verträglichkeit (EMV) <i>Electromagnetic compatibility (EMC)</i>	gemäß IEC / EN 60601-1-2 <i>according to EN 60601-1-2</i>
Richtlinie über Medizinprodukte 93/42/EWG <i>Medical Device Directive 93/42/EEC</i>	Klasse IIb <i>Class IIb</i>
Schutz gegen elektrischen Schlag <i>Protection against electric shock</i>	Anwendungsteil des Typs CF <i>Application part of Type CF</i>
Schutzgrad gegen Eindringen von Flüssigkeit <i>Degree of protection against penetration of liquids</i>	IP 20 (nicht geschützt) <i>IP 20 (not protected)</i>
Betriebsart <i>Duty cycle</i>	Dauerbetrieb <i>Continuous operation</i>
Schutzgrad bei Anwendung in Gegenwart von brennbaren Gemischen <i>Degree of protection when flammable mixtures are present</i>	Gerät ist nicht explosionsgeschützt (Gerät nicht in zündfähiger Atmosphäre betreiben) <i>This device is not protected against explosions (Do not operate this device in areas where explosive substances are present)</i>
Gewicht <i>Weight</i>	8,9 kg (19,5 lbs) <i>8.9 kg (19.5 lbs)</i>
Abmessungen (B x H x T) <i>Dimensions (W x H x D)</i>	300 mm x 160 mm x 455 mm
Spannung <i>Voltage</i>	100 - 240 V~ / a.c.
Frequenz <i>Frequency</i>	50 / 60 Hz
Leistungsaufnahme <i>Power consumption</i>	60 VA
Sicherung <i>Fuse</i>	T 3,15 H <i>T 3.15 H</i>
Stromaufnahme <i>Power rating</i>	0,6 - 0,2 A <i>0.6 - 0.2 A</i>

#### Relevante Anwendungsparameter / Relevant application parameters:

Insufflationsmedium <i>Insufflation medium</i>	med. CO <sub>2</sub> (Reinheitsgrad > 99,5 %) <i>med. CO<sub>2</sub> (purity &gt; 99,5 %)</i>
Intraabdominalen Druck <i>Intra-abdominal pressure</i>	3 mmHg bis / to 25 mmHg, (± 2 mmHg) vorwählbar / <i>preselectable</i> in 1 mmHg - Schritten / <i>Steps</i>
Gasflussrate: - Primärfüllung - High Flow  <i>Gas flow rate: - primary filling - high flow</i>	1 l/min. (± 50 %) 2 l/min. bis 45 l/min. (± 20 %) vorwählbar in 1 l/min Schritten <i>1 l/min. 2 l/min. to 45 l/min. (± 20 %) preselectable in 1 l/min steps</i>
Verbrauchsanzeige <i>Consumption display</i>	0 l bis 9999 l (± 20 %) <i>0 l to 9999 l (± 20 %)</i>

# INSUFFLATOR Highflow 45 HEAT

# INSUFFLATOR Highflow 45 HEAT



- 6.5" Color display
- Touchscreen
- Max. flow rate 45 l / min
- Functional and user-friendly design
- CO<sub>2</sub> gas heating function
- Optional configurable software modules

- 6,5" Farbdisplay
- Touchscreen
- Max. Flowrate 45 l / min
- Funktionelles und anwenderfreundliches Design
- CO<sub>2</sub>-Gaserwärmungsfunktion
- Optional konfigurierbare Software-Module

### INSUFFLATOR Highflow 45 HEAT Set

consisting of:

INSUFFLATOR Highflow 45 HEAT (2235021),  
Insufflation tube, with heating element, High-Flow,  
3m long, autoclavable (8170202)  
hygiene filter, sterile PACK=10 PCS (4171.111) and  
power cable 3 m long (2440.03) .....22350211

Necessary accessories:

#### CO<sub>2</sub> pressure tube

Length 1.5 m ..... 74021.029  
with

#### Pressure reducer CO<sub>2</sub>

DIN 477-1 ..... 74007.054

DIN EN ISO 407 ..... 74007.055

ISO 5145 ..... 74007.056

or

#### Connecting tube, 5 m long

for central CO<sub>2</sub> gas supply (Dräger) ..... 74021.030

#### Connecting tube, 5 m long

for central CO<sub>2</sub> gas supply (Air Liquide) ..... 74021035

Optional accessories:

#### Insufflation tube, disposable

with heating element, High-Flow, with integrated hygiene filter,  
PACK=10 PCS, in individual sterile packs ..... 4170502

Optional software module:

Software module CAN-BUS, integrated core ..... 2235101

Software module BABY-MODE ..... 2235102

Software module VIDEO-DISPLAY ..... 2235103

### INSUFFLATOR Highflow 45 HEAT Set

bestehend aus:

INSUFFLATOR Highflow 45 HEAT (2235021),  
Insufflationsschlauch mit Heizspirale, High-Flow,  
3m lang, autoklavierbar (8170202)  
Hygiene-Filter, VE=10 ST, steril verpackt (4171.111) und  
Netzkabel 3 m lang (2440.03) ..... 22350211

Erforderliches Zubehör:

#### CO<sub>2</sub>-Druckschlauch

Länge 1,5 m ..... 74021.029  
mit

#### Druckminderer CO<sub>2</sub>

DIN 477-1 ..... 74007.054

DIN EN ISO 407 ..... 74007.055

ISO 5145 ..... 74007.056

oder

#### Verbindungsschlauch, 5 m lang,

für zentrale CO<sub>2</sub>-Gasversorgung (Dräger) ..... 74021.030

#### Verbindungsschlauch, 5 m lang,

für zentrale CO<sub>2</sub>-Gasversorgung (Air Liquide) ..... 74021035

Optionales Zubehör:

#### Insufflationsschlauch, zum Einmalgebrauch

mit Heizspirale, High-Flow, mit integriertem Hygienefilter,  
VE=10 ST, einzeln steril verpackt ..... 4170502

Optionale Software-Module:

Softwaremodul CAN-BUS, Integration in core ..... 2235101

Softwaremodul BABY-MODE ..... 2235102

Softwaremodul VIDEOEINBLENDUNG ..... 2235103

15

## INSUFFLATOR Highflow 45 HEAT Technical data

## INSUFFLATOR Highflow 45 HEAT Technische Daten

Schutzklasse nach IEC / EN 60601-1 ; (UL 60601-1 / CSA C22.2 No.601.1 - für USA) <i>Protection class complying with IEC / EN 60601-1 ; (UL 60601-1 / CSA C22.2 No.601.1 - for USA)</i>	1
Elektromagnetische Verträglichkeit (EMV) <i>Electromagnetic compatibility (EMC)</i>	gemäß IEC / EN 60601-1-2 <i>according to EN 60601-1-2</i>
Richtlinie über Medizinprodukte 93/42/EWG <i>Medical Device Directive 93/42/EEC</i>	Klasse IIb <i>Class IIb</i>
Schutz gegen elektrischen Schlag <i>Protection against electric shock</i>	Anwendungsteil des Typs CF <i>Application part of Type CF</i>
Schutzgrad gegen Eindringen von Flüssigkeit <i>Degree of protection against penetration of liquids</i>	IP 20 (nicht geschützt) <i>IP 20 (not protected)</i>
Betriebsart <i>Duty cycle</i>	Dauerbetrieb <i>Continuous operation</i>
Schutzgrad bei Anwendung in Gegenwart von brennbaren Gemischen <i>Degree of protection when flammable mixtures are present</i>	Gerät ist nicht explosionsgeschützt (Gerät nicht in zündfähiger Atmosphäre betreiben) <i>This device is not protected against explosions (Do not operate this device in areas where explosive substances are present)</i>
Gewicht <i>Weight</i>	11,0 kg (23,3 lbs) <i>11.0 kg (23.3 lbs)</i>
Abmessungen (B x H x T) <i>Dimensions (W x H x D)</i>	300 mm x 160 mm x 455 mm
Spannung <i>Voltage</i>	100 - 127 / 220 - 240 V~ / a.c.
Frequenz <i>Frequency</i>	50 / 60 Hz
Leistungsaufnahme <i>Power consumption</i>	80 VA
Sicherung <i>Fuse</i>	T 3,15 H <i>T 3.15 H</i>
Stromaufnahme <i>Power rating</i>	0,8 - 0,3 A <i>0.8 - 0.3 A</i>

### Relevante Anwendungsparameter / Relevant application parameters:

Insufflationsmedium <i>Insufflation medium</i>	med. CO <sub>2</sub> (Reinheitsgrad > 99,5 %) <i>med. CO<sub>2</sub> (purity &gt; 99,5 %)</i>
Intraabdominalen Druck <i>Intra-abdominal pressure</i>	3 mmHg bis / to 25 mmHg, (± 2 mmHg) vorwählbar / preselectable in 1 mmHg - Schritten / Steps
Gasflussrate: - Primärfüllung - High Flow <i>Gas flow rate: - primary filling - high flow</i>	1 l/min. (± 50 %) 2 l/min. bis 45 l/min. (± 20 %) vorwählbar in 1 l/min Schritten 1 l/min. 2 l/min. to 45 l/min. (± 20 %) preselectable in 1 l/min steps
Verbrauchsanzeige <i>Consumption display</i>	0 l bis 9999 l (± 20 %) <i>0 l to 9999 l (± 20 %)</i>
Gastemperatur mit Heizschlauch <i>Gas temperature with airbag</i>	37 °C ± 2°C

## INSUFFLATOR Highflow 45 HEAT EVAC + HEAT

## INSUFFLATOR Highflow 45 EVAC + HEAT



- 6.5" Color display
- Touchscreen
- Max. flow rate 45 l / min
- Functional and user-friendly design
- CO<sub>2</sub> gas heating function
- Optional configurable software modules
- Smoke gas evacuation

- 6,5" Farbdisplay
- Touchscreen
- Max. Flowrate 45 l / min
- Funktionelles und anwenderfreundliches Design
- CO<sub>2</sub>-Gaserwärmungsfunktion
- Optional konfigurierbare Software-Module
- Rauchgasabsaugung

### INSUFFLATOR Highflow 45 EVAC + HEAT Set

consisting of: INSUFFLATOR Highflow 45 EVAC + HEAT (2235031), Insufflation tube, with heating element, High-Flow, 3m long, autoclavable (8170202), insufflation tube, disposable with heating element, High-Flow, with integrated hygiene filter, PACK=10 PCS, in individual sterile packs (4170502), hygiene filter, sterile PACK=10 PCS (4171.111), disposable tube set for smoke gas evacuation, sterile (PACK=10 PCS) (4170503), one-pedal footswitch (20301031) and power cable 3 m long (2440.03) ..... 22350311

#### Necessary accessories:

**CO<sub>2</sub> pressure tube**  
Length 1.5 m ..... 74021.029  
with

**Pressure reducer CO<sub>2</sub>**  
DIN 477-1 ..... 74007.054  
DIN EN ISO 407 ..... 74007.055  
ISO 5145 ..... 74007.056  
or

**Connecting tube, 5 m long**  
für zentrale CO<sub>2</sub> gas supply (Dräger) ..... 74021.030  
**Connecting tube, 5 m long**  
für zentrale CO<sub>2</sub> gas supply (Air Liquide) ..... 74021035

**Disposable tube set for smoke gas evacuation,**  
sterile (PACK=10 PCS) ..... 4170503

#### Optional accessories:

**Insufflation tube, disposable**  
with heating element, High-Flow, with integrated hygiene filter,  
PACK=10 PCS, in individual sterile packs ..... 4170502

#### Optional software module:

**Software module CAN-BUS, integrated core** ..... 2235101  
**Software module BABY-MODE** ..... 2235102  
**Software module VIDEO-DISPLAY** ..... 2235103

### INSUFFLATOR Highflow 45 EVAC + HEAT Set

bestehend aus:  
INSUFFLATOR Highflow 45 EVAC + HEAT (2235031), Insufflations-  
schlauch mit Heizspirale, High-Flow, 3m lang, autoklavierbar (8170202),  
Insufflationsschlauch, zum Einmalgebrauch mit Heizspirale, High-  
Flow, mit integriertem Hygienefilter, VE=10 ST, einzeln steril verpackt  
(4170.502), Hygiene-Filter, VE=10 ST, steril verpackt (4171.111),  
Rauchgasabsaugung steril (4170503), Einpedal-Fußschalter  
(20301031) und Netzkabel 3 m lang (2440.03) ..... 22350311

#### Erforderliches Zubehör:

**CO<sub>2</sub>-Druckschlauch**  
Länge 1,5 m ..... 74021.029  
mit

**Druckminderer CO<sub>2</sub>**  
DIN 477-1 ..... 74007.054  
DIN EN ISO 407 ..... 74007.055  
ISO 5145 ..... 74007.056  
oder

**Verbindungsschlauch, 5 m lang,**  
für zentrale CO<sub>2</sub>-Gasversorgung (Dräger) ..... 74021.030  
**Verbindungsschlauch, 5 m lang,**  
für zentrale CO<sub>2</sub>-Gasversorgung (Air Liquide) ..... 74021035

**Einweg-Schlauchset Rauchgasabsaugung,**  
steril (VE=10 ST) ..... 4170503

#### Optionales Zubehör:

**Insufflationsschlauch, zum Einmalgebrauch**  
mit Heizspirale, High-Flow, mit integriertem Hygienefilter,  
VE=10 ST, einzeln steril verpackt ..... 4170502

#### Optionale Software-Module:

**Softwaremodul CAN-BUS, Integration in core** ..... 2235101  
**Softwaremodul BABY-MODE** ..... 2235102  
**Softwaremodul VIDEOEINBLENDUNG** ..... 2235103

## INSUFFLATOR Highflow 45 EVAC + HEAT

### Technical data

## INSUFFLATOR Highflow 45 EVAC + HEAT

### Technische Daten

Schutzklasse nach IEC / EN 60601-1 ; (UL 60601-1 / CSA C22.2 No.601.1 - für USA) <i>Protection class complying with IEC / EN 60601-1 ; (UL 60601-1 / CSA C22.2 No.601.1 - for USA)</i>	1
Elektromagnetische Verträglichkeit (EMV) <i>Electromagnetic compatibility (EMC)</i>	gemäß IEC / EN 60601-1-2 <i>according to EN 60601-1-2</i>
Richtlinie über Medizinprodukte 93/42/EWG <i>Medical Device Directive 93/42/EEC</i>	Klasse IIb <i>Class IIb</i>
Schutz gegen elektrischen Schlag <i>Protection against electric shock</i>	Anwendungsteil des Typs CF <i>Application part of Type CF</i>
Schutzgrad gegen Eindringen von Flüssigkeit <i>Degree of protection against penetration of liquids</i>	IP 20 (nicht geschützt) <i>IP 20 (not protected)</i>
Betriebsart <i>Duty cycle</i>	Dauerbetrieb <i>Continuous operation</i>
Schutzgrad bei Anwendung in Gegenwart von brennbaren Gemischen <i>Degree of protection when flammable mixtures are present</i>	Gerät ist nicht explosionsgeschützt (Gerät nicht in zündfähiger Atmosphäre betreiben) <i>This device is not protected against explosions (Do not operate this device in areas where explosive substances are present)</i>
Gewicht <i>Weight</i>	11,0 kg (23,3 lbs) <i>11.0 kg (23.3 lbs)</i>
Abmessungen (B x H x T) <i>Dimensions (W x H x D)</i>	300 mm x 160 mm x 455 mm
Spannung <i>Voltage</i>	100 - 127 / 220 - 240 V~ / a.c.
Frequenz <i>Frequency</i>	50 / 60 Hz
Leistungsaufnahme <i>Power consumption</i>	80 VA
Sicherung <i>Fuse</i>	T 3,15 H <i>T 3.15 H</i>
Stromaufnahme <i>Power rating</i>	0,8 - 0,3 A <i>0.8 - 0.3 A</i>

#### Relevante Anwendungsparameter / Relevant application parameters:

Insufflationsmedium <i>Insufflation medium</i>	med. CO <sub>2</sub> (Reinheitsgrad > 99,5 %) <i>med. CO<sub>2</sub> (purity &gt; 99,5 %)</i>
Intraabdominalen Druck <i>Intra-abdominal pressure</i>	3 mmHg bis / to 25 mmHg, (± 2 mmHg) vorwählbar / <i>preselectable</i> in 1 mmHg - Schritten / <i>Steps</i>
Gasflussrate: - Primärfüllung - High Flow  <i>Gas flow rate: - primary filling - high flow</i>	1 l/min. (± 50 %) 2 l/min. bis 45 l/min. (± 20 %) vorwählbar in 1 l/min Schritten 1 l/min. 2 l/min. to 45 l/min. (± 20 %) <i>preselectable in 1 l/min steps</i>
Verbrauchsanzeige <i>Consumption display</i>	0 l bis 9999 l (± 20 %) <i>0 l to 9999 l (± 20 %)</i>
Gastemperatur mit Heizschlauch <i>Gas temperature with airbag</i>	37 °C ± 2°C

## Laparo CO<sub>2</sub>-Pneu 2233

## Laparo - CO<sub>2</sub> - Pneu 2233



- Automatic pressure and flow control
- High degree of safety during laparoscopy
- Functional and user-friendly design
- Max. flow rate 20 l / min

- Automatische Druck- und Flow-Regelung
- Hohe Sicherheit während der Laparoskopie
- Funktionelles und anwenderfreundliches Design
- Max. Flowrate 20 l / min

### Laparo CO<sub>2</sub>-Pneu 2233 bundle

including:

Laparo-CO<sub>2</sub>-Pneu 2233 (2233.001),  
insufflation tube, Ø 5 mm, 2,5 m long (8170.101),  
hygiene filter, sterile PACK=10 PCS (4171.111),  
power cable 3 m long (2440.03) ..... 2233.0011

### Laparo-CO<sub>2</sub>-Pneu komplett

einschließlich:

Laparo-CO<sub>2</sub>-Pneu 2233 (2233.001),  
Insufflationsschlauch, Ø 5 mm, 2,5 m lang (8170.101),  
Hygiene-Filter, VE=10 ST, steril verpackt (4171.111),  
Netzkabel 3 m lang (2440.03) ..... 2233.0011

Necessary accessories:

#### CO<sub>2</sub> pressure tube

Length 1.5 m ..... 74021.029

#### Connecting tube, 5 m long

for central CO<sub>2</sub> gas supply (Dräger) ..... 74021.030

#### Connecting tube, 5 m long

for central CO<sub>2</sub> gas supply (Air Liquide) ..... 74021035

#### Pressure reducer CO<sub>2</sub>

DIN 477-1 ..... 74007.054

DIN EN ISO 407 (PIN index) ..... 74007.055

ISO 5145 ..... 74007.056

Optimal accessories:

#### Insufflation tube, disposable

with integrated hygiene filter,

PACK=10 PCS, in individual sterile packs ..... 4170.501

Erforderliches Zubehör:

#### CO<sub>2</sub>-Druckschlauch

Länge 1,5 m ..... 74021.029

#### Verbindungsschlauch, 5 m lang,

für zentrale CO<sub>2</sub>-Gasversorgung (Dräger) ..... 74021.030

#### Verbindungsschlauch, 5 m lang,

für zentrale CO<sub>2</sub>-Gasversorgung (Air Liquide) ..... 74021035

#### Druckminderer CO<sub>2</sub>

DIN 477-1 ..... 74007.054

DIN EN ISO 407 (PIN-Index) ..... 74007.055

ISO 5145 ..... 74007.056

Optionales Zubehör:

#### Insufflationsschlauch, zum Einmalgebrauch

mit integriertem Hygienefilter,

VE=10 ST, einzeln steril verpackt ..... 4170.501

## Laparo CO<sub>2</sub> - Pneu 2233

### Technical data

## Laparo - CO<sub>2</sub> - Pneu 2233

### Technische Daten

Schutzklasse nach VDE 0750 / IEC 601 <i>Protection class complying with VDE 0750 / IEC 601</i>	1
Elektromagnetische Verträglichkeit (EMV) gemäß EN 60601-1-2 <i>Electromagnetic compatibility (EMC) according to EN 60601-1-2</i>	Klasse B <i>Class B</i>
Klassifikation <i>Classification</i>	CF
EU-Klassifikation <i>EU classification</i>	2 b
Betriebsbedingungen <i>Operating conditions</i>	+10°C bis + 40°C, 30% bis 75% rel. Luftfeuchte <i>+10°C to + 40°C, 30% to 75% rel. humidity</i>
Lager- und Transportbedingungen <i>Storage and transportation conditions</i>	-20°C bis + 60°C, 10% bis 90% rel. Luftfeuchte <i>-20°C to + 60°C, 10% to 90% rel. humidity</i>
Gewicht <i>Weight</i>	ca. / approx. 9.5 kg
Abmessungen (B x H x T) <i>Dimensions (W x H x D)</i>	330 mm x 155 mm x 390 mm
Spannung <i>Voltage</i>	100 - 230 V~ / a.c.
Frequenz <i>Frequency</i>	50 / 60 Hz
Leistungsaufnahme <i>Power consumption</i>	max. 80 VA
Sicherung <i>Fuse</i>	T 2,0 L <i>2.0 L (s.b.)</i>

#### Relevante Anwendungsparameter / Relevant application parameters:

Insufflationsmedium <i>Insufflation medium</i>	CO <sub>2</sub>
Vorwahl des intraabdominalen Drucks <i>Preselection of intra-abdominal pressure</i>	3 - 25 mm Hg, vorwählbar in 1 mm Hg-Schritten <i>3 - 25 mm Hg, preselectable in 1 mm Hg steps</i>
Gasflussrate: - Primärfüllung - High Flow  <i>Gas flow rate</i> - primary filling - high flow	1 l / min. 1 l / min. - 20 l / min., vorwählbar in 1 l / min.-Schritten  1 l / min. 1 l / min. - 20 l / min., preselectable in 1 l / min. steps

## VERES Cannulas

for establishing the pneumoperitoneum

## VERES-Kanülen

zur Anlage des Pneumoperitoneums

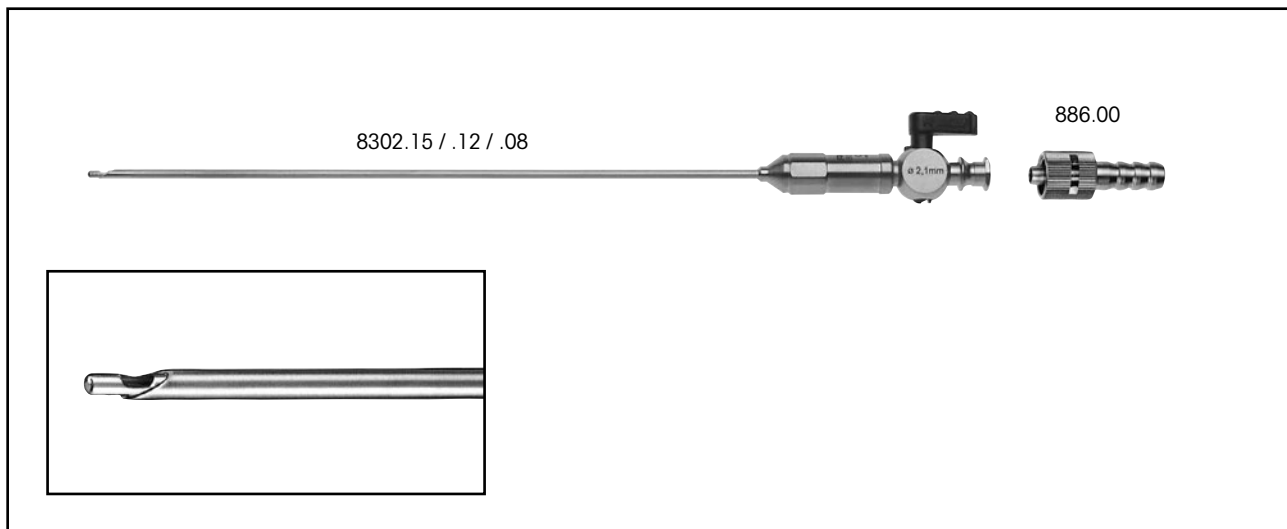

### VERES cannula

150 mm working length .....	8302.15
120 mm working length (standard length) .....	8302.12
80 mm working length .....	8302.08

also:

<b>Luer connector</b> .....	886.00
-----------------------------	--------

### VERES-Kanüle

150 mm Nutzlänge .....	8302.15
120 mm Nutzlänge (Standardlänge) .....	8302.12
80 mm Nutzlänge .....	8302.08

hierzu:

<b>Luer-Schlauchteil</b> .....	886.00
--------------------------------	--------



*Smoke-Evacuation Filter*  
*for smoke gas discharge*

**Rauchgasablassfilter**  
zur Rauchgasausleitung

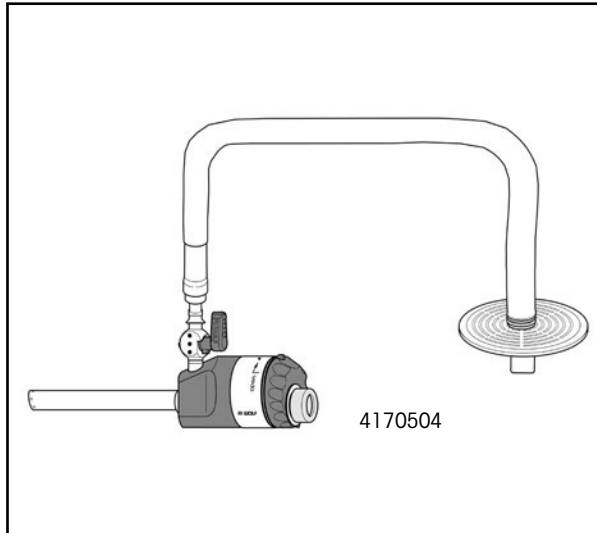

Optionales Zubehör:

**Rauchgasablassfilter, steril,**

Einmalartikel, VE=10 ST,

einzel steril verpackt ..... 4170504

*Optional accessories:*

**Smoke-evacuation filter, sterile,**

single use article, PACK=10 PCS, sterile,

individually packed ..... 4170504

## FLUID CONTROL 2225

Suction and irrigation pump

## FLUID CONTROL 2225

Saug- und Spülpumpe



### Flexibilität

- One pump. Three disciplines.**  
*Interdisciplinary application in gynecology, urology and general surgery*
- No license fee**  
*Interdisciplinary application without any additional costs*
- Individual instrument presets**  
*for maximum irrigation performance*
- Mobile balancing module**  
*Easy switching between operating theaters*
- Compatible with endoscopes from other manufacturers**  
*when standard mode is selected*
- One tube set for all applications**  
*as a disposable or reusable solution*
- Integrated core nova interface**  
*Control via core nova operating integration system possible*

### Performance

- 1800 ml/min irrigation performance\***
- 2000 ml/min suction performance\***
- Continuous irrigation flow** even in small sized instruments
- Integrated vacuum function**  
*Fast exchange of fluid for optimum visualization conditions*
- 60% higher irrigation performance**  
*compared to previous models*

### Safety

- Outstanding visualization in any surgical circumstances**  
*as a result of permanent irrigation flow and vacuum function*
- Large, clear touchscreen color display**
- Continuous monitoring and display of fluid deficit**  
*throughout the entire intervention*
- Two integrated weighing cell** for precise balancing
- System monitoring**  
*Warning messages and signals if there are any deviations*

\* depending on the discipline and intervention

### Flexibilität

- Eine Pumpe. Drei Fachgebiete**  
*Interdisziplinäre Verwendung in der Gynäkologie, Urologie und Chirurgie*
- Keine Lizenzgebühren**  
*Interdisziplinäre Nutzung ohne zusätzliche Kosten*
- Individuelle Instrumenten-Presets**  
*für maximale Spülleistung*
- Mobiles Bilanzierungsmodul**  
*Einfacher Wechsel zwischen den OP-Sälen*
- Kompatibel mit Endoskopen anderer Hersteller**  
*bei Auswahl des Standard-Modus*
- Ein Schlauchset für alle Anwendungen**  
*als Ein- oder Mehrweg-Lösung*
- Integrierte core nova-Schnittstelle**  
*Steuerung über core nova OP-Integrationssystem möglich*

### Leistung

- 1800 ml/min Spülleistung\***
- 2000 ml/min Absaugleistung\***
- Kontinuierlicher Spülstrom**  
*selbst bei dünnlumigen Instrumenten*
- Integrierte Vakuum-Funktion**  
*Schneller Flüssigkeitsaustausch für optimale Sichtverhältnisse*
- 60% höhere Spülleistung** gegenüber Vorgängermodell

### Sicherheit

- Hervorragende Sicht in jeder OP-Situation**  
*durch gleichmäßigen Spülstrom und Vakuum-Funktion*
- Großes, übersichtliches Touchscreen-Farbdisplay**
- Durchgängige Kontrolle und Anzeige des Flüssigkeitsdefizits**  
*während des gesamten Eingriffes*
- Zwei integrierte Wiegezellen** für eine genaue Bilanzierung
- Systemüberwachung**  
*Warnhinweise und -signale bei Abweichungen*

\* abhängig von Fachdisziplin und Eingriff

## FLUID CONTROL 2225

Suction and irrigation pump

## FLUID CONTROL 2225

Saug- und Spülpumpe



core

### FLUID CONTROL 2225

#### Irrigation pump for HYS / URO / LAP

Fluid management for irrigation of irrigation fluids into the uterus and the upper and lower urinary tract, and for the suction-irrigation function in the abdomen

FLUID CONTROL 2225 ..... 2225001

FLUID CONTROL 2225, incl. power cable ..... 22250011

### FLUID CONTROL 2225

#### Spülpumpe für HYS / URO / LAP

Fluidmanagement zur Irrigation von Spülflüssigkeiten in den Uterus sowie den oberen und unteren Harntrakt, wie auch zur Saug-Spülfunktion im Abdomen

FLUID CONTROL 2225 ..... 2225001

FLUID CONTROL 2225, inkl. Netzkabel ..... 22250011

### Balancing module

for hysteroscopy and endourology, fluid management for fluid balancing in combination with FLUID CONTROL 2225, mobile stands with integrated load cells and accommodation for up to 4 irrigation fluid bags ..... 2225023

### Bilanzierungsmodul

für die Hysteroskopie und Endourologie, Fluidmanagement zur Flüssigkeitsbilanzierung in Kombination mit FLUID CONTROL 2225, Fahrständer mit integrierten Wiegezellen und Aufnahme für bis zu 4 Spülflüssigkeitsbeutel ..... 2225023

Recommended accessories:

#### Footswitch

only usable in urology and within the indication TUR / enucleation, possibility of short-term increase in pressure if visualization conditions are poor ("Flush" function) ..... 2204901

Empfohlenes Zubehör:

#### Fußschalter

verwendbar nur in der Urologie und innerhalb der Indikation TUR / Enukleation, Möglichkeit zur kurzzeitigen Druckerhöhung bei schlechten Sichtverhältnissen ("Flush"-Funktion) ..... 2204901

## FLUID CONTROL 2225

### Accessories

**Irrigation tube set**, with piercing connector, 3 m,  
with Y-piece, with Luer lock connector,  
PACK= 10 PCS, sterile, for single use ..... 4171223

**Irrigation tube set**, with Care lock, 3 m,  
PACK= 10 PCS, sterile, for single use ..... 4171224

**Suction-irrigation tube set**,  
3 m, PACK= 10 PCS, sterile, for single use ..... 4171225

**Irrigation tube set**, with piercing connector,  
with Luer lock connection, incl. 10 replacement membranes,  
reusable, 20 x autoclavable ..... 8171223\*

**Tube set** with Y-piece, 5 m  
PACK=10 PCS, sterile, for single use ..... 4170.901

**Vacuum tube**,  
silicon, reusable, 20x autoclavable ..... 8170.401\*

**Vacuum tube with filter**, 1.7 m ..... 2206207

**Tube adapter**,  
with Luer lock connector, for suction irrigation handle 8385.901  
and tube set 8171223 or 8170.223,  
reusable ..... 817123\*

**Drain tube**, 3 m  
for suction irrigation handle 8385.901  
reusable ..... 8171402

**Protective filter for gas filtration** for single use ..... 4171.121\*

**Suction container**, 3 l  
incl. mounting bracket, reusable ..... 8170.981

**Suction container**, 3 l  
PACK= 2 PCS, for single use ..... 2215.971

### Wiring accessories

**Patch cable**, RJ45 SFTP,  
cable length 0.5 m ..... 72325378  
cable length 1.0 m ..... 72325429  
cable length 10 m ..... 72325434  
**Plastic cap for network socket**, PACK= 8 PCS ..... 5592105  
**Fuse**, 5 x 20, 3,15 AT, VE= 2 ST ..... 64268.007  
**Power cable**, cable length 2.0 m ..... 2440.03

\* not for U.S. device

## FLUID CONTROL 2225

### Zubehör

**Spülschlauchset** mit Anstechdorn, 3 m  
mit Y-Stück, mit Luer-Lock-Anschluss,  
VE= 10 ST, steril, zum Einmalgebrauch ..... 4171223

**Spülschlauchset** mit Care-Lock, 3 m  
VE= 10 ST, steril, zum Einmalgebrauch ..... 4171224

**Saug-Spülschlauchset** 3 m  
VE= 10 ST, steril, zum Einmalgebrauch ..... 4171225

**Spülschlauchset**, mit Anstechdorn,  
mit Luer-Lock-Anschluss, inkl. 10 Ersatzmembranen,  
wiederverwendbar, 20x autoklavierbar ..... 8171223\*

**Schlauchset** mit Y-Stück, 5 m  
VE= 10 ST, steril, zum Einmalgebrauch ..... 4170.901

**Vakuum-Schlauch**,  
wiederverwendbar, 20x autoklavierbar ..... 8170.401\*

**Vakuum-Schlauch mit Filter**, 1,7 m ..... 2206207

**Schlauchansatz**  
mit Luer-Lock-Anschluss, für Saug-Spül-Handgriff 8385.901  
und Schlauchset 8171223 oder 8170.223,  
wiederverwendbar ..... 817123\*

**Saugschlauch**, 3 m  
für Saug-Spül-Handgriff 8385.901  
wiederverwendbar ..... 8171402

**Schutzfilter zur Gasfiltration** zum Einmalgebrauch ..... 4171.121\*

**Saug-Behälter**, 3 l  
inkl. Halterung, wiederverwendbar ..... 8170.981

**Saug-Behälter**, 3 l  
VE= 2 ST, zum Einmalgebrauch ..... 2215.971

### Verkabelungszubehör

**Patchkabel**, RJ45 SFTP,  
Kabellänge 0,5 m ..... 72325378  
Kabellänge 1,0 m ..... 72325429  
Kabellänge 10 m ..... 72325434  
**Plastikkappe für Netzwerkbuchse**, VE= 8 ST ..... 5592105  
**Sicherung**, 5 x 20, 3,15 AT, VE= 2 ST ..... 64268.007  
**Netzkabel**, Kabellänge 2,0 m ..... 2440.03

\* nicht für US-Gerät

## Fluid Control LAP 2216

## Fluid Control LAP 2216



- Effective irrigation and aspiration of fluids during laparoscopic, minimally invasive surgery
- Simple handling and straightforward unit design
- Optimum irrigation and aspiration performance
- Compatible with suction-irrigation instruments with integrated valves, particularly suitable for modular suction/irrigation handles from R. WOLF
- Extremely safe due to intelligent pressure management
- Simple attachment to irrigator stands or unit trolleys

- Effektives Spülen und Absaugen von Flüssigkeiten im Rahmen der laparoskopischen, minimal invasiven Chirurgie
- Einfaches Handling durch unkomplizierten Geräteaufbau
- Optimale Spül- und Saugleistung
- Kompatibel zu Saug-Spülinstrumenten mit integrierten Ventilen, besonders geeignet für modularen Saug-Spülhandgriff von R. WOLF
- Hohe Sicherheit durch intelligentes Druckmanagement
- Einfache Befestigung an Irrigatorständer oder Gerätewagen

### FLUID CONTROL LAP 2216 Set

consisting of:

FLUID CONTROL LAP 2216 (2216001)  
and power cable (2440.03) ..... 22160011

### FLUID CONTROL LAP 2216 Set

bestehend aus:

FLUID CONTROL LAP 2216 (2216001) und  
Netzkaabel (2440.03) ..... 22160011

Accessories:

- Tubing set with piercing connector,**  
(for irrigation), with luer-lock connector, autoclavable,  
incl. 10 replacement membranes,  
reusable for 20 reprocessing cycles ..... 8171223
- Tubing set with piercing connector,**  
(for irrigation), with luer-lock connector,  
sterile single use item, PACK=10 PCS ..... 4171223
- Tubing set with Care-Lock®,**  
(for irrigation), sterile single use item, PACK=10 PCS ..... 4171224
- Tubing set with piercing connector,**  
(for irrigation) with connector for suction-irrigation handle (8385.901),  
incl. drain tube, sterile single use item,  
PACK=10 PCS ..... 4171225
- Tubing set reusable,**  
(vacuum tube) autoclavable ..... 8170.401
- Protective filter for gas filtration, hydrophobic, (hygiene filter) ....** 4171.121
- Suction container PSU, 3 liter, autoclavable.....** 8170.981
- Suction container, 3 liter, single use item, PACK=2 .....** 2215.971
- Holder, for fixing the suction container**  
on irrigator stand or MUT cart ..... 2215.992
- Universal holder, for FLUID CONTROL LAP 2216**  
on RIWomobil ..... 32114605

Zubehör:

- Schlauchset mit Anstechdorn,**  
(zur Spülung), mit Luer-Lock Anschluss, autoklavierbar,  
incl. 10 Ersatzmembranen,  
wiederverwendbar für 20 Aufbereitungszyklen ..... 8171223
- Schlauchset mit Anstechdorn,**  
(zur Spülung), mit Luer-Lock Anschluss,  
steriler Einmalartikel, VE=10 ST ..... 4171223
- Schlauchset mit Care-Lock®,**  
(zur Spülung), steriler Einmalartikel, VE=10 ST ..... 4171224
- Schlauchset mit Anstechdorn,**  
(zur Spülung), mit Anschlussstück für Saug-Spül-Handgriff  
(8385.901), inkl. Ablaufschlauch, steriler Einmalartikel,  
VE=10 ST ..... 4171225
- Schlauchset wiederverwendbar,**  
(Vakuumschlauch) autoklavierbar ..... 8170.401
- Schutzfilter für Gasfiltration, hydrophob, (Hygienefilter) ....** 4171.121
- Saugbehälter PSU, 3 Liter, autoklavierbar .....** 8170.981
- Saugbehälter, 3 Liter, Einmalartikel, VE= 2 Stück .....** 2215.971
- Halterung, zum Befestigen für Saugbehälter**  
am Irrigatorständer oder MUT-Wagen ..... 2215.992
- Universalhalterung, für FLUID CONTROL LAP 2216**  
an RIWomobil ..... 32114605

## Fluid Control LAP 2216

### Technical data















## Fluid Control LAP 2216

### Technische Daten

Klassifikation gemäß Richtlinie 93/42/EWG <i>Classification in conformity with guideline 93/42/EEC</i>	IIa
Schutzklasse <i>Safety class</i>	I
Schutzgrad <i>Degree of protection</i>	Type BF
Schutzart (IP Code) <i>Protection rating (IP Code)</i>	IP41
Netzanschluss <i>Power supply</i>	100 - 240 V~, 50 / 60 Hz <i>100 - 240 V a.c., 50 / 60 Hz</i>
Max. Leistungsaufnahme <i>Max. power consumption</i>	52 VA
Max. Stromaufnahme <i>Max. current consumption</i>	100 V: 0,5 A, 240 V: 0,22 A
Maximale Förderleistung <i>Maximum capacity (min)</i>	Spülen: 2,0 l/min ( $\pm 10\%$ ), Saugen: 2,0 l/min (+0,4/-0,1 l/min) <i>Irrigation: 2.0 l/min (<math>\pm 10\%</math>), Aspiration: 2.0 l/min (+0,4/-0,1 l/min)</i>
Maximaler Pumpdruck <i>Maximum pump pressure</i>	400 mm Hg ( $\pm 50$ mm Hg)
Motorabschaltung <i>Motor cut-out</i>	500 mm Hg nach 5 s ( $\pm 25$ mm Hg)
Saugdruck <i>Suction pressure</i>	zwischen -50 kpa und -60 kpa <i>between -50 kpa and -60 kpa</i>
Anschlüsse <i>Connections</i>	Potentialausgleich, Vakuumanschluss, <i>Equipotential bonding, vacuum connection, service connection</i>
Abmessungen: Breite x Höhe x Tiefe <i>Dimensions: width x height x depth</i>	mit Knebelschraube / with clamping screw 140 x 210 x 295 mm <i>ohne Knebelschraube / without clamping screw 140 x 210 x 200 mm</i>
Gewicht <i>Weight</i>	ca. 4 kg <i>approx. 4 kg</i>
Hergestellt und geprüft nach <i>Manufactured and tested in conformity with</i>	IEC 60601-1 / EN 60601-1











## HF Monopolar Connecting Cables

## HF-Monopolar Anschlusskabel

Anschluss Instrument <i>Connector for instrument</i>	Anschluss Gerät <i>Connector for unit</i>	Länge <i>Length</i>	Typen <i>Types</i>	
<b>WOLF - Resektoskope</b> <b>WOLF resectoscopes</b> 	 ERBE (ACC / ICC) / BOWA (EU)	3 m	<b>815.032</b>	
		5 m	<b>815.052</b>	
	 ERBE (T-Serie) ERBE (T series)	3 m	<b>815.132</b>	
		5 m	<b>815.152</b>	
	 Martin (m-Version) / Berchtold / Aesculap	3 m	<b>815.031</b>	
		5 m	<b>815.051</b>	
	 Bovie / Valleylab / Erbe (Int.) / BOWA (Int.)	3 m	<b>815.033</b>	
		5 m	<b>815.053</b>	
	<b>HF-Elektroden, monopolar</b> <b>Monopolar HF electrodes</b> 	 BOWA (Int. / EU) Eschmann und andere Geräte mit 4 mm Stecker <i>Eschmann and other devices with 4 mm connectors</i>	3 m	<b>815.034</b>
			5 m	<b>815.054</b>
<b>WOLF - Instrumente</b> <b>WOLF instruments</b> 	 ERBE (ACC / ICC) / BOWA (EU)	3 m	<b>8106.032</b>	
		5 m	<b>8106.052</b>	
	 ERBE (T-Serie) ERBE (T series)	3 m	<b>8106.132</b>	
		5 m	<b>8106.152</b>	
	 Martin (m-Version) / Berchtold / Aesculap	3 m	<b>8106.031</b>	
		5 m	<b>8106.051</b>	
	 Bovie / Valleylab / Erbe (Int.) / BOWA (Int.)	3 m	<b>8106.033</b>	
		5 m	<b>8106.053</b>	
	<b>HF-Elektroden, monopolar</b> <b>Monopolar HF electrodes</b> 	 BOWA (Int. / EU) Eschmann und andere Geräte mit 4 mm Stecker <i>Eschmann and other devices with 4 mm connectors</i>	3 m	<b>8106.034</b>
			5 m	<b>8106.054</b>

## HF Bipolar Connecting Cables

## HF-Bipolar Anschlusskabel

Anschluss Instrument <i>Connector for instrument</i>	Anschluss Gerät <i>Connector for unit</i>	Länge <i>Length</i>	Typen <i>Types</i>	
 <p><b>WOLF Bipolar-Zangen</b> <i>WOLF bipolar forceps</i></p>		3 m	<b>8108.032</b>	
	ERBE (ACC / ICC / T) / BOWA (EU)	5 m	<b>8108.052</b>	
		3 m	<b>8108.033</b>	
	Martin (Int.) / 2 pin Valleylab / BOWA (Int.)	5 m	<b>8108.053</b>	
		3 m	<b>8108.031</b>	
	WOLF / Martin (m-Version) / Berchtold / Aesculap	5 m	<b>8108.051</b>	
		3 m	<b>8108035</b>	
	EMC Dolley	5 m	<b>8108055</b>	
	 <p><b>Bipolar-Pinzetten Anschluss</b> <i>Bipolar tweezers</i></p>		3 m	<b>8108.132</b>
		ERBE (ACC / ICC / T) / BOWA (EU)	5 m	<b>8108.152</b>
		3 m	<b>8108.133</b>	
Martin (Int.) / 2 pin Valleylab / BOWA (Int.)		5 m	<b>8108.153</b>	
		3 m	<b>8108.131</b>	
WOLF / Martin (m-Version) / Berchtold / Aesculap		5 m	<b>8108.151</b>	
		3 m	<b>8108135</b>	
EMC Dolley		5 m	<b>8108155</b>	



**Flexible Fiber Choledochoscope**  
5 mm  
Channel 2.5 mm

**Flexibles Fiber-Choledochoskop**  
5 mm  
Kanal 2,5 mm

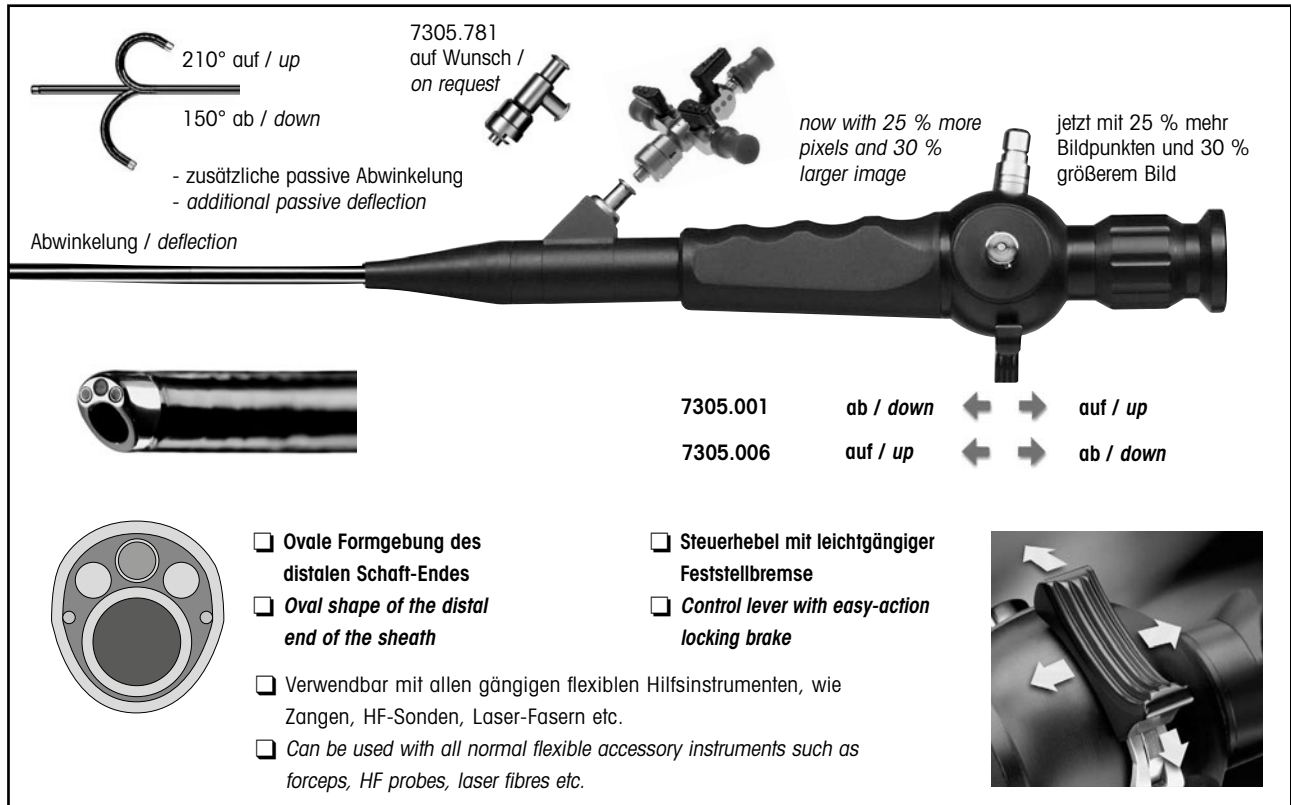

210° auf / up  
150° ab / down  
- zusätzliche passive Abwinkelung  
- additional passive deflection  
Abwinkelung / deflection

7305.781 auf Wunsch / on request

now with 25 % more pixels and 30 % larger image  
jetzt mit 25 % mehr Bildpunkten und 30 % größerem Bild

7305.001 ab / down ← → auf / up  
7305.006 auf / up ← → ab / down

- Ovale Formgebung des distalen Schaft-Endes
- Oval shape of the distal end of the sheath
- Steuerhebel mit leichtgängiger Feststellbremse
- Control lever with easy-action locking brake
- Verwendbar mit allen gängigen flexiblen Hilfsinstrumenten, wie Zangen, HF-Sonden, Laser-Fasern etc.
- Can be used with all normal flexible accessory instruments such as forceps, HF probes, laser fibres etc.

- Safe and atraumatic passage through the urethra is provided by the oblique distal tip
- Reduced weight and ergonomic design for optimal handling and less strain on the operator
- 0° viewing direction, 120° angle of view
- Immersible and gas sterilisable
- Sichere und atraumatische Passage der Harnröhre durch angeschrägtes distales Schaft-Ende
- Gewichtsreduzierte Bauweise und ergonomisches Design für optimales Handling und ermüdungsfreies Arbeiten
- 0° Blickrichtung, 120° Bildwinkel
- Einleg- und gassterilisierbar

Flexibles Fiber-Cystoskop komplett Flexible fibre-cystoscope bundle	im Set enthaltenes Fiber-Cystoskop included in set Fiber-cystoscope	Außen-Durchmesser Outer diameter	Sondenkanal Instrument channel	Nutzlänge Working length	Set
bestehend aus: Fiber-Urethro-Cystoskop, Ansatz mit Einführungshahn (7305.782), Dichtigkeitstester (163.903), Gassteri-Ventil (163.904), Einmal-Reinigungsbürste (7990002), Koffer consisting of: Fiber-urethro-cystoscope, instrument port (7305.782), leak tester (163.903), gas sterilisation valve (163.904), disposable cleaning brush (7990002), case	7305.001	5 mm 15 Charr. / Fr.	2.5 mm 7.5 Charr. / Fr.	400 mm	Steuerhebel nach distal - Abwinkelung nach unten Forward movement of the control lever provides downward movement of the tip <b>730500111</b>
	7305.006				Steuerhebel nach distal - Abwinkelung nach oben Forward movement of the control lever provides upward movement of the tip <b>730500611</b>

hierzu / also: <b>Fiber Lichtleiter Set, Ø 2,5 mm</b> bestehend aus: Fiber Lichtleiter (80662523), Adapter projektorseitig (8095.07) und Adapter endoskopseitig (809509) <b>Fiber light cable set, Ø 2.5 mm</b> consisting of: Fiber light cable (80662523), adapter projector side (8095.07) and adapter endoscope side (809509)				2.3 m lang / long	<b>806625231</b>
---	--	--	--	----------------------	------------------

## Tuebinger MIC Trainer

## Tübinger MIC-Trainer

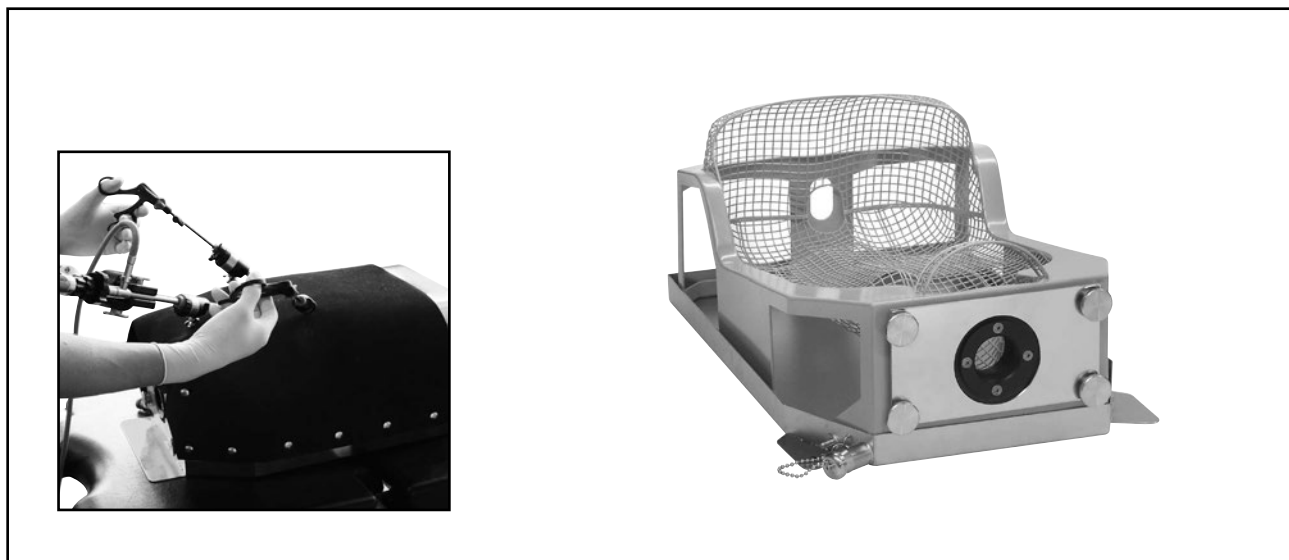

### Tuebinger MIC Trainer

with 3 abdominal walls (rubber sponge)

(L x W x H) 550 mm x 340 mm x 220 mm ..... 9500.056

**Spare abdominal walls** (rubber sponge),

PACK=5 PCS..... 9500.0561

### Tübinger MIC-Trainer

mit 3 Bauchdecken (Moosgummi)

(L x B x H) 550 mm x 340 mm x 220 mm ..... 9500.056

**Ersatz-Bauchdecken** (Moosgummi),

VE=5 ST ..... 9500.0561

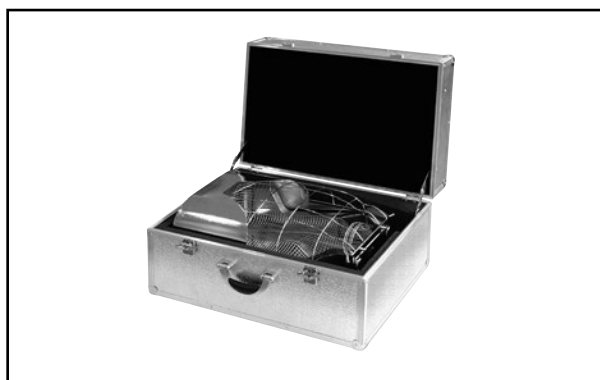

Auf Wunsch auch mit Transportkoffer lieferbar.

*On request available with carrying case.*

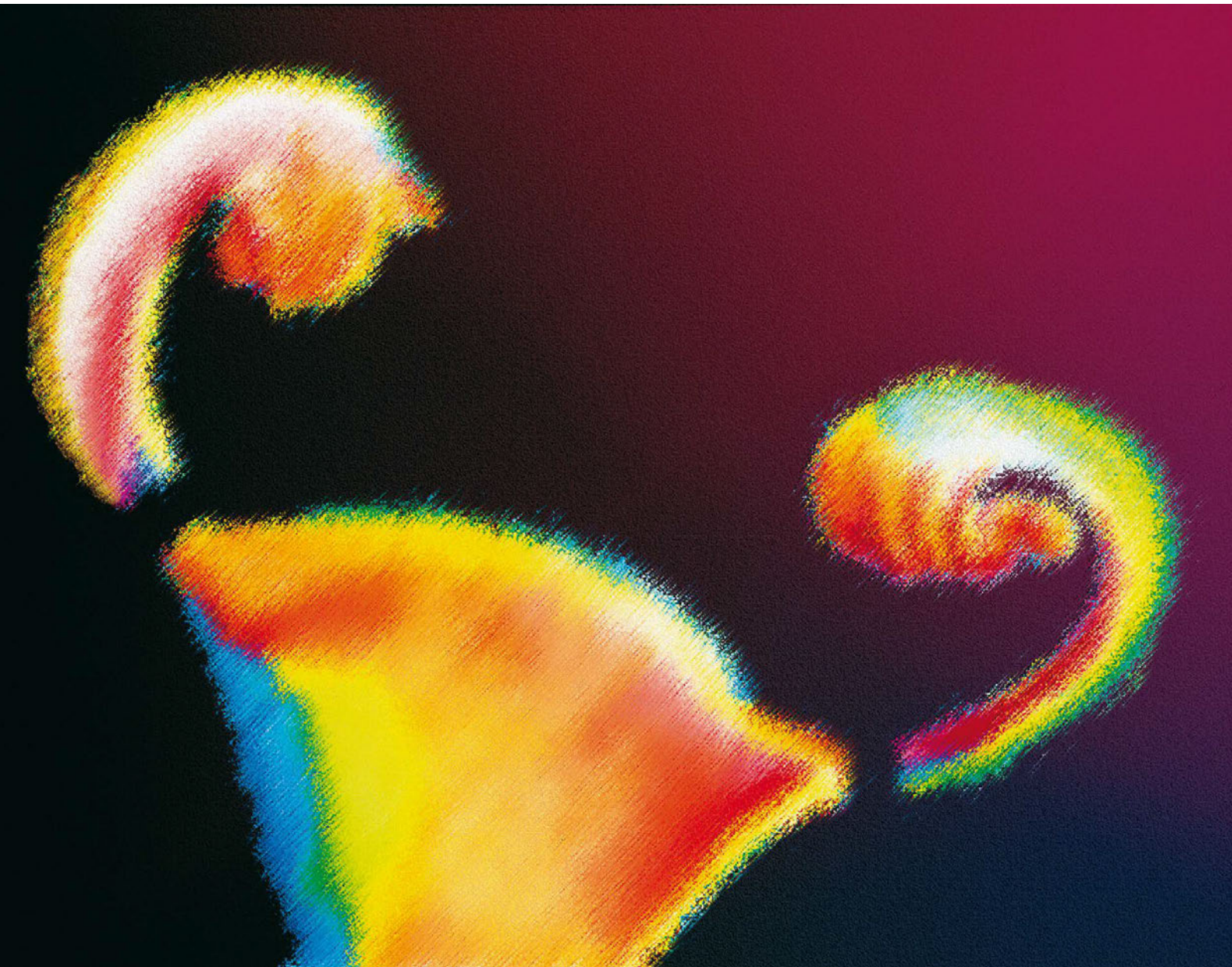

**Hysterektomie**

*Hysterectomy*

## Hysterectomy

## Hysterektomie

1

Secu**Fix** Uterus Manipulator

Secu**Fix** Uterus Manipulator

## SecuFIX Uterusmanipulator

System with Colpotransillumination and Vacuum Fixation

## SecuFIX Uterusmanipulator

System mit Colpotransillumination und Vakuum-Fixation



- Atraumatic and safe fixation using vacuum aspiration
- Colpotransillumination for optimum visualization of the vaginal fornix and an elastic vaginal cuff for reliable gas sealing
- Universal, conical dome and adjustable uterus probe for adaptation to all anatomical variations
- Stable modular three-part construction

- Atraumatische Fixation durch Vakuum-Ansaugung
- Colpotransillumination für eine optimale Darstellung der Schnittkante und elastische Vaginalmanschette zur permanenten Gasabdichtung
- Universelle, konische Formation und verstellbare Uterussonde zur Anpassung unterschiedlicher Anatomien
- Stabiler dreiteiliger modularer Aufbau

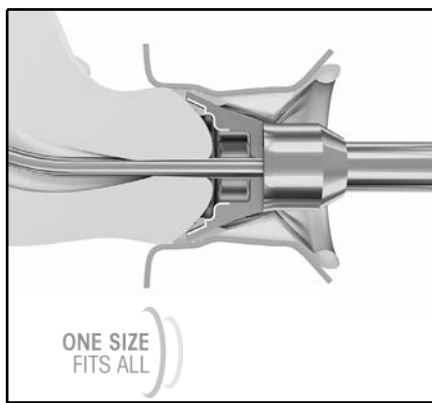
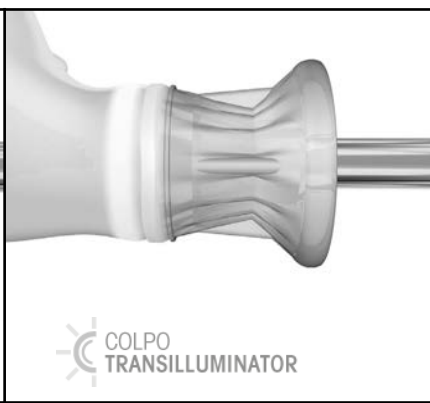
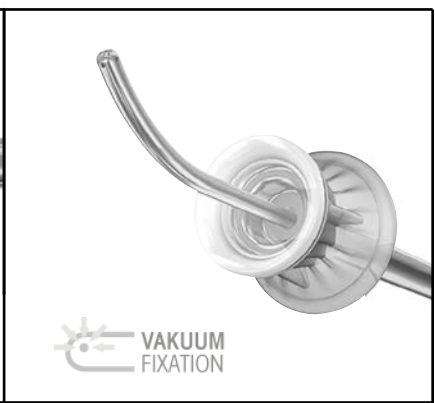
 <p>ONE SIZE FITS ALL</p>	 <p>COLPO TRANSILLUMINATOR</p>	 <p>VAKUUM FIXATION</p>
<p>Durch die konische Formation der Manipulator Glocke und die Abstufungen in der Kappe selbst ist ein Ansaugen der Portio unterschiedlicher Größen möglich. Die elastische Vaginalmanschette sorgt für eine optimale Abdichtung der Scheide und somit für ein stabiles Pneumoperitoneum in allen Phasen des Eingriffs.</p> <p><i>The conical shape of the manipulator dome and the gradations in the cap itself mean that portios of all sizes can be accommodated. The elastic vaginal cuff guarantees an optimum seal for the vagina and hence a stable pneumoperitoneum through all phases of the intervention.</i></p>	<p>Die ringförmige Illumination sorgt für die optimale Darstellung der Schneidekante und dient gleichzeitig als Ausleuchtungsunterstützung während des vaginalen Anlegens des Manipulators.</p> <p><i>The annular illumination provides optimum visualization of the cutting edge and at the same time serves as supporting illumination while the manipulator is positioned in the vagina.</i></p>	<p>Die Ansaugung in der Gebärmutter und im Zervix ermöglicht die atraumatische und sichere Fixation. Die intraperitoneale Zellverschleppung wird dadurch vermieden.</p> <p><i>The aspiration in the uterus and in the cervix permits atraumatic and secure fixation. This avoids intraperitoneal cell dislocation.</i></p>

## SecuFIX Uterusmanipulator

System with Colpotransillumination and Vacuum Fixation

## SecuFIX Uterusmanipulator

System mit Colpotransillumination und Vakuum-Fixation

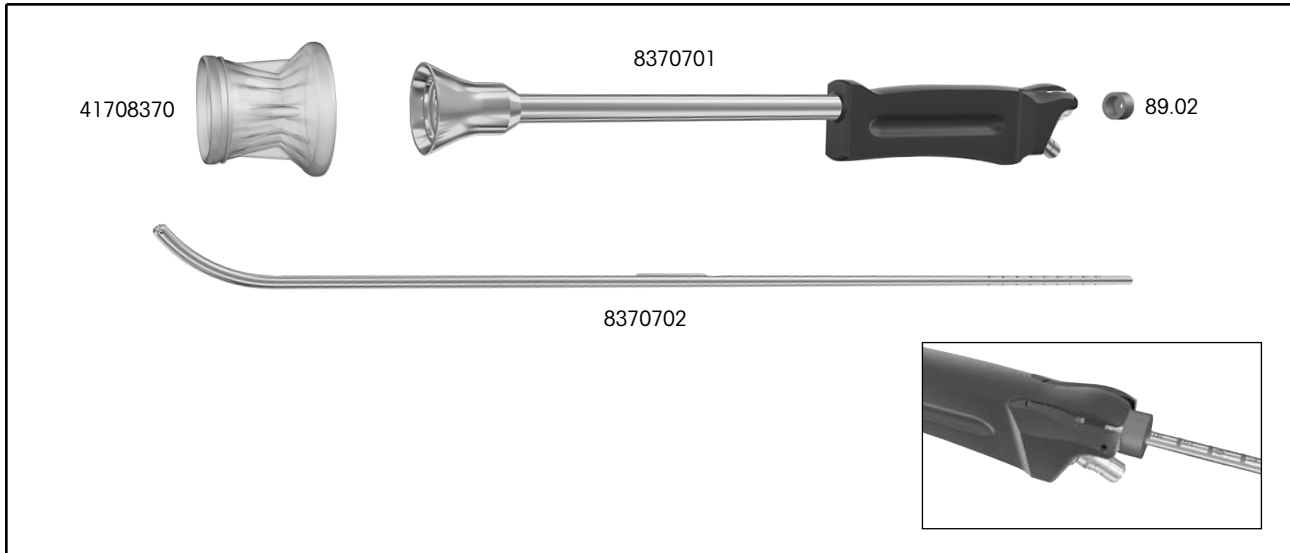

### SecuFIX

#### Uterusmanipulator bndl

comprising:

SecuFix Uterus Manipulator (8370701), Uterus Probe with longitudinal scale (8370702), Colpotransilluminator vacuum tube, (PACK= 10 PCS, packed singly, sterile) (41708370), cleaning brush Ø 5 mm, TL 515 mm (6.05), cleaning brush (6.09), seal cap 3.4-5.1mm (pack of 10) (89.02) ..... 83707011



#### Accessories:

##### Fiber light cable bndl,

fiber bundle Ø 3.5 mm (color marking orange),  
length 2.3 m ..... 806635231

##### Irrigation tube L 0.6m

for machine cleaning ..... 163915

##### RIWO System Tray

Steri container,  
inside dimensions (L x W x H): 500 x 200 x 60 mm,  
steam sterilizable ..... 38201.586

### SecuFIX

#### Uterusmanipulator kpl

bestehend aus:

Uterusmanipulator Ø 36 mm (8370701), Uterussonde Ø 5 mm (8370702), Colpotransilluminator Vakuumschlauch (VE=10 ST, einzeln steril verpackt) (41708370), Reinigungsbürste Ø 5 mm, TL 515 mm (6.05), Reinigungsbürste Ø 5 mm, GL 515 mm (6.09), Dichtungskappe DL 3,4-5,1mm (VE=10 St.) (89.02) ..... 83707011

### SecuFIX

#### Colpotransilluminator Vakuumschlauch

(VE=10 ST, einzeln steril verpackt)

mit Rückschlagventil, Sauganschluss, Y-Verbindungsteil bei Verwendung eines Sauginstrumentes bei gleichem Absauggerät, Schlauchklemme, Einmalgebrauchsartikel ..... 41708370

### SecuFIX

#### Colpotransilluminator vacuum tube

(PACK=10 PCS, packed singly, sterile)

with nonreturn valve, suction connector, Y-shaped adapter for use with a suction instrument on the same suction unit, suction clamp, for single use ..... 41708370

#### Zubehör

##### Fiber Lichtleiter kpl,

Faserbündel-Ø 3,5 mm, (Farbmarkierung orange),  
Länge 2,3 m ..... 806635231

##### Spülschlauch L 0,6m

für die maschinelle Reinigung ..... 163915

##### RIWO-System-Tray

Steri behälter,  
Innenmaß (L x B x H): 500 x 200 x 60 mm,  
dampfsterilisierbar ..... 38201.586

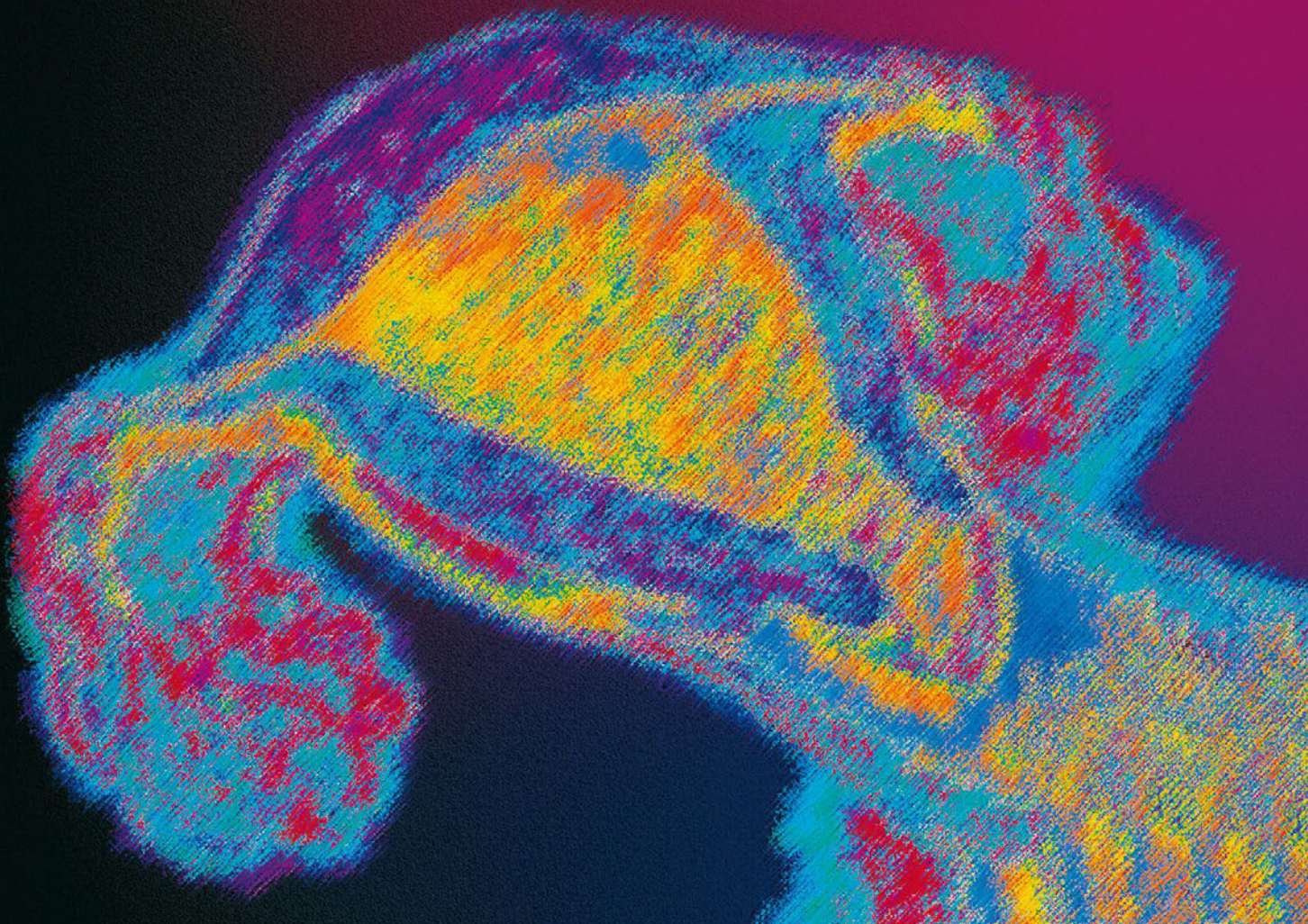

**Diagnostische und operative  
Hysteroskopie**

***Diagnostic and operative  
Hysteroscopy***

## Diagnostic and operative Hysteroscopy





## Diagnostische und operative Hysteroskopie

1	<i>Basic Sets</i>	Basis-Sets
2	<i>Telescopes</i>	Optiken
3	<i>For 2.7 mm Telescope: Hysteroscope Sheaths / Inserts</i>	Für 2,7 mm-Optik: Hysteroskop-Schäfte / Einsätze
4	<i>For 4 mm Telescope: Hysteroscope Sheaths</i>	Für 4 mm-Optik: Hysteroskop-Schäfte
5	<i>Compact Hysteroscope Ø 3.8 mm, 30°</i>	Kompakt-Hysteroskop Ø 3,8 mm, 30°
6	<i>Compact Hysteroscope Ø 5 mm, 20°</i>	Kompakt-Hysteroskop Ø 5 mm, 20°
7	<i>Rigid Forceps 7 Fr.</i>	Starre Zange 7 Charr.
8	<i>Forceps / Scissors micro modular system <b>HySafe</b></i>	Zangen / Scheren Kleinmodulares System <b>HySafe</b>
9	<i>Flexible Forceps 3 Fr.</i>	Flexible Zangen 3 Charr.
10	<i>Electrodes, bipolar, monopolar</i>	Elektroden, bipolar, monopolar
11	<i>Instruments for Cervix and Uterus</i>	Instrumente für Portio und Uterus
12	<i>Hystero Resection</i>	Hystero-Resektion
13	<i>Flexible Hysteroscope</i>	Flexibles Hysteroskop
14	<i>Units</i>	Geräte
15	<i>HF Connecting Cables</i>	HF-Anschlusskabel



*Basic Set for Diagnostic  
Hysteroscopy*

*Basis-Set zur diagnostischen  
Hysteroskopie*

<b>ohne Arbeitskanal without working channel</b>		
	<b>PANOVIEW Optik, 30°, 2,7 mm</b> <i>PANOVIEW Telescope, 30°, 2.7 mm</i>	<b>8974.402</b>
	<b>Schaff für Hysteroskop 10,5 Ch</b> <i>Sheath for hysteroscope 10,5 Fr</i>	<b>8985.11</b>
	<b>PE-Zange kpl, starr, 5 Charr.</b> <i>Biopsy forceps bndl, rigid, 5 Fr.</i>	<b>8642.6312</b>
	<b>Greifzange kpl, starr, 5 Charr.</b> <i>Grasping forceps bndl, rigid, 5 Fr.</i>	<b>8642.6502</b>
<b>alternativ alternatively</b>		
	<b>Hysteroskop kpl 3,8mm</b> bestehend aus: Kompakt-Hysteroskop 30° (8986402) und Gummikappe "RIWO", rot (VE=10 St., 88.01) <b>Hysteroscope bndl 3.8mm</b> consisting of: Compact Hysteroscope 30° (8986402) and rubber cap "RIWO", red (pack of 10, 88.01)	<b>89864021</b>











1

### Basic Set Hystero-Resectoscope

PRINCESS<sup>®</sup> E-line & S(a)line System,  
Telescope 2.7 mm, 12°  
21 Fr., passive, continuous irrigation

### Basis-Set Hystero-Resektoskop

PRINCESS<sup>®</sup> E-line & S(a)line System,  
Optik 2,7 mm, 12°,  
21 Charr., passiv, Dauerspülung

	Außenschaft, 21 Charr. <i>Outer sheath, 21 Fr.</i>	<b>8653.021</b>
	Innenschaft, 19 Charr. <i>Inner sheath, 19 Fr.</i>	<b>8653.018</b>
	Obturator <i>Obturator</i>	<b>8653.18</b>
	Arbeitselement, offen, passiv <i>Working elements, open, passive</i>	<b>8653.224</b>
	PANOVIEW Optik, 12°, <i>PANOVIEW telescope, 12°</i>	<b>8974.412</b>
	Schneide-Elektrode, bipolar, VE= 3 ST, einzeln steril verpackt <i>Cutting electrode, bipolar, PACK=3 PCS, sterile individually packaged</i>	<b>4653.1313</b>
	Rollen-Elektrode, bipolar, VE= 3 ST, einzeln steril verpackt <i>Roller electrode, bipolar, pack of 3, sterile individually packaged</i>	<b>4653.023</b>
	Haken-Elektrode, monopolar und bipolar <i>Hook electrode, monopolar and bipolar</i>	<b>865303</b>
	Sterilisations-Schutzhülse <i>Protective sterilization sleeve</i>	<b>8428.901</b>
	HF-Bipolar Anschlusskabel <i>HF bipolar connecting cable</i>	<b>8108...</b>
	FLUID CONTROL 2225 Saugpumpe / <i>irrigation pump</i>	<b>22250011</b>
	mit / <i>with</i> Bilanzierungsmodul / <i>Balancing modul</i>	<b>2225023</b>

*Mini Fibre Hysteroscope*  
2 mm, 0°

Mini-Fiber-Hysteroskop  
2 mm, 0°

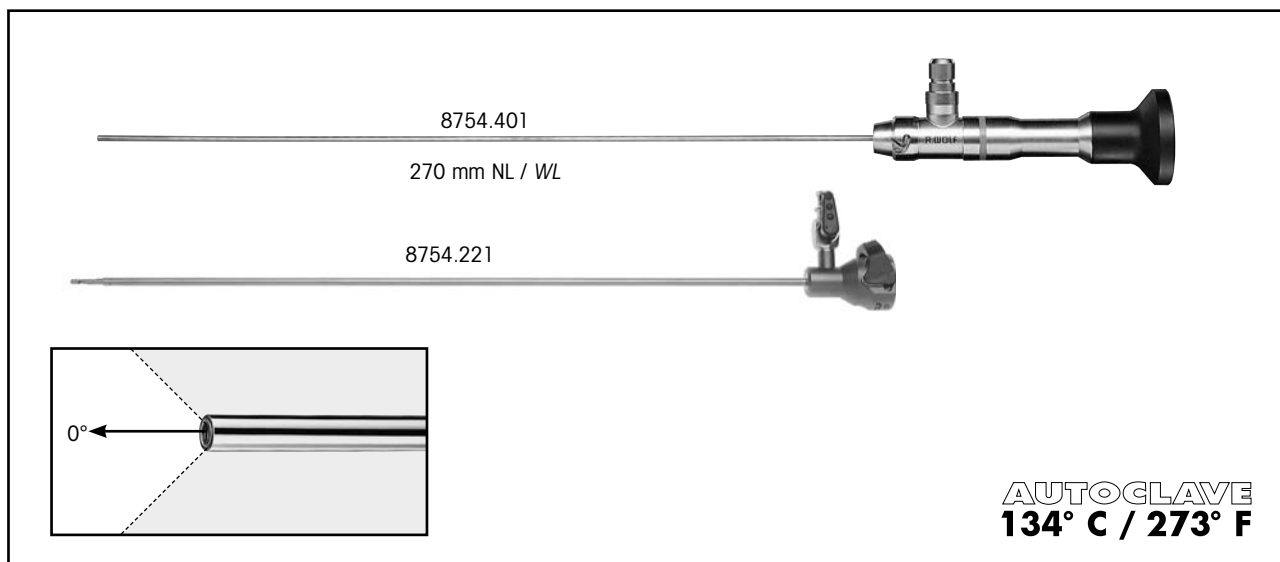

2

**WL 270 mm standard version**

**Telescope**

Ø 2 mm, 0° ..... 8754.401

**Outer sheath**

Ø 2,8 mm, with insufflation tap, WL 250 mm ..... 8754.221

**NL 270 mm Standard-Ausführung**

**Optik**

Ø 2 mm, 0° ..... 8754.401

**Außenschaft**

Ø 2,8 mm, mit Insufflationshahn, NL 250 mm ..... 8754.221

*Recommended light cable:*

**Fiber light cable bndl**, Ø 2.5 mm, 2.3 m long consisting of:

Fiber light cable (80662523), adapter projector-side (8095.07) and adapter endoscope-side (809509) ..... 806625231 (for maximum light transmission)

*Accessories:*

**Reprocess basket**

(L x W x H) 471 x 59 x 54 mm ..... 38021.111

*Empfohlenes Lichtleitkabel:*

**Fiber Lichtleiter kpl**, Ø 2,5 mm, 2,3 m lang bestehend aus:

Fiber Lichtleiter (80662523), Adapter projektorseitig (8095.07) und Adapter endoskopseitig (809509) ..... 806625231 (für maximale Lichttransmission)

*Zubehör:*

**Aufbereitungskorb**

(L x B x H) 471 x 59 x 54 mm ..... 38021.111

# Mini Operating Hysteroscope, by Solima-Zupi

# Mini-OP-Hysteroskop nach Solima-Zupi

2

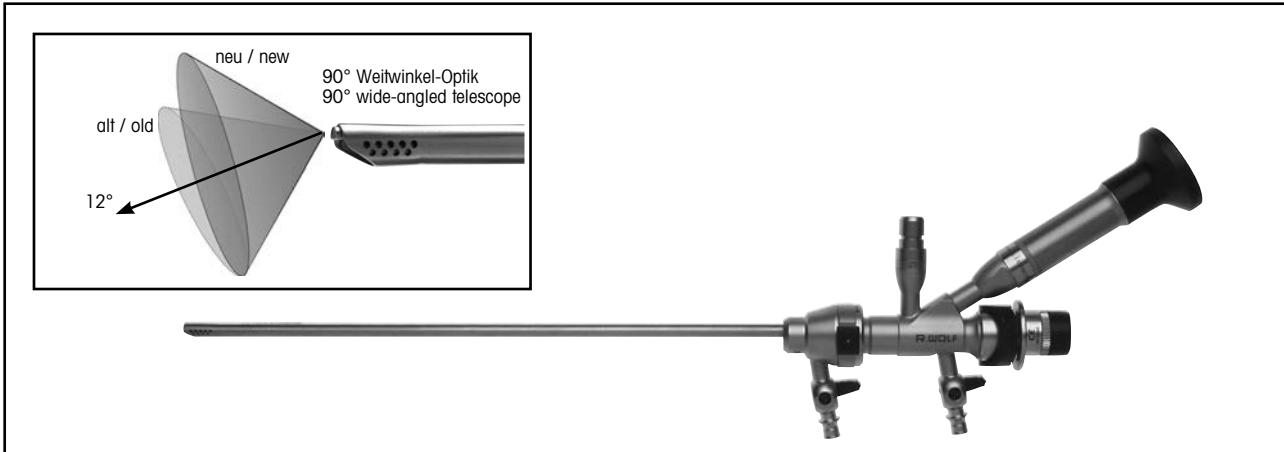

Farbmarkierung / Colour code	Außen-Ø / Outer-Ø	Arbeitskanal / Working channel	Aussenschaft / Outer sheath	Innenschaft / Inner sheath	Basis Optik / Basic telescope 2 mm, 12°
gelb / yellow	3.8 mm	3 Ch. / Fr.	<b>8753.001</b>	<b>8753.002</b>	<b>8753.411</b>
blau / blue	4.8 mm	5 Ch. / Fr.	<b>8753.003</b>	<b>8753.004</b>	
grün / green	5.4 mm	7 Ch. / Fr.	<b>8753.006</b>	<b>8753.007</b>	
weiß / white	5.8 mm	9 Ch. / Fr.	<b>8753.008</b>	<b>8753.009</b>	

- Modular construction for one basic telescope
- High resolution fibre-optic system, 50.000 pixels and 12° direction of view
- Automatic seal on instrument port - single handed operation
- Snap-on connection
- Very effective flow characteristics
- Straight instrument channel

- Modularer Aufbau um eine Basis-Optik
- Hochauflösendes fiberoptisches System, 50.000 Pixel und 12° Blickrichtung
- Automatische Dichtung für den Arbeitskanal - Einhandbedienung
- Schnappverschluss
- Sehr effektive Spülleistung
- Gerader Instrumentenkanal

Spezielles Zubehör / Special accessories:		
	<b>Starre Fasszange 3 mm,</b> NL 340 mm <b>Grasping forceps 3 mm,</b> WL 340 mm	<b>8993.235</b>

**Recommended light cable:**

**Fiber light cable bndI**, Ø 2.5 mm, 2.3 m long  
consisting of:

Fiber light cable (80662523), adapter projector-side (8095.07) and  
adapter endoscope-side (809509) ..... 806625231  
(for maximum light transmission)

**Empfohlenes Lichtleitkabel:**

**Fiber Lichtleiter kpl**, Ø 2,5 mm, 2,3 m lang  
bestehend aus:

Fiber Lichtleiter (80662523), Adapter projektorseitig (8095.07) und  
Adapter endoskopseitig (809509) ..... 806625231  
(für maximale Lichttransmission)

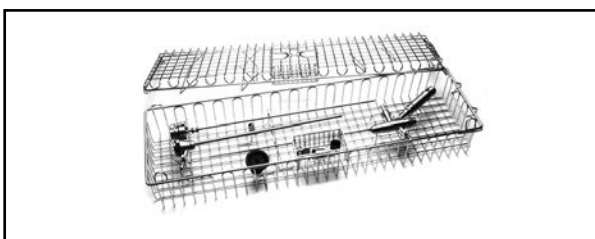

**Aufbereitungskorb**

für Wechselschaft-Hysteroskop (8753.411) mit  
Aufnahme für Wechselschäfte, Maße (B x L x H):  
131,5 x 471,5 x 74 mm ..... 38044.311

**Reprocessing basket**

for exchangeable sheath hysteroscope (8753.411)  
with mounting for exchangeable sheaths,  
dimensions (W x L x H): 131.5 x 471.5 x 74 mm ..... 38044.311

*Hysteroscope Telescopes*  
2.7 mm

Hysteroskop-Optiken  
2,7 mm

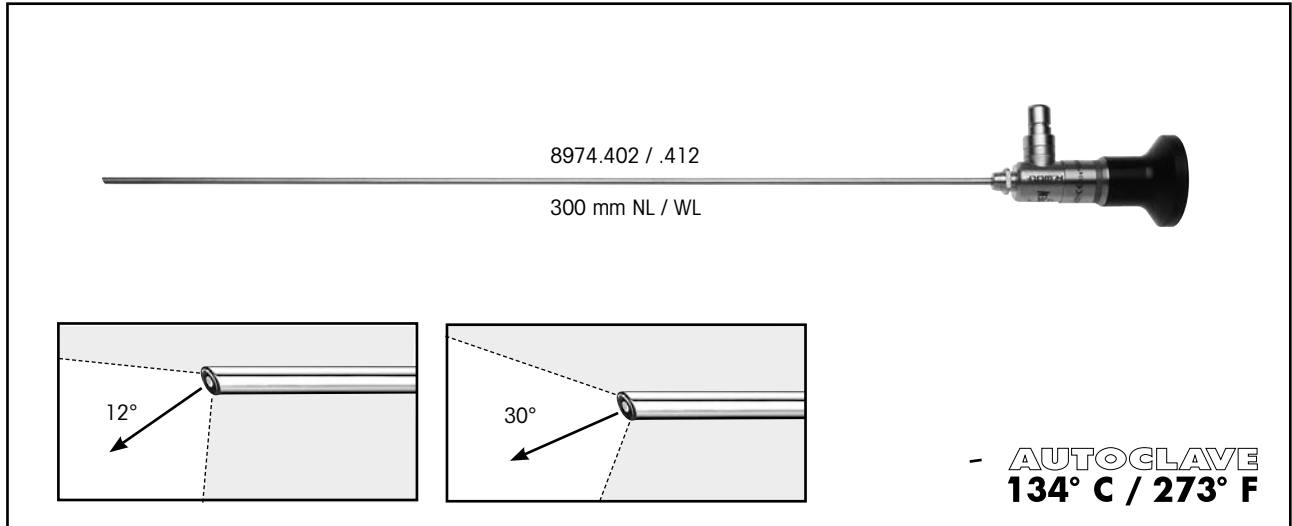

**PANOVIEW telescope, Ø 2.7 mm,**

12° .....	8974.412
30° .....	8974.402

**PANOVIEW Optik, Ø 2,7 mm,**

12° .....	8974.412
30° .....	8974.402

*Recommended light cable:*

**Fiber light cable bndI, Ø 2.5 mm, 2.3 m long consisting of:**

Fiber light cable (80662523), adapter projector-side (8095.07) and  
adapter endoscope-side (809509) ..... 806625231  
(for maximum light transmission)

*Accessories:*

**Reprocess basket**

(L x W x H) 471 x 59 x 54 mm ..... 38021.111

*Empfohlenes Lichtleitkabel:*

**Fiber Lichtleiter kpl, Ø 2,5 mm, 2,3 m lang bestehend aus:**

Fiber Lichtleiter (80662523), Adapter projektorseitig (8095.07) und  
Adapter endoskopseitig (809509) ..... 806625231  
(für maximale Lichttransmission)

*Zubehör:*

**Aufbereitungskorb**

(L x B x H) 471 x 59 x 54 mm ..... 38021.111

*Hysteroscope Telescope*  
4 mm, 30°

Hysteroskop-Optik  
4 mm, 30°

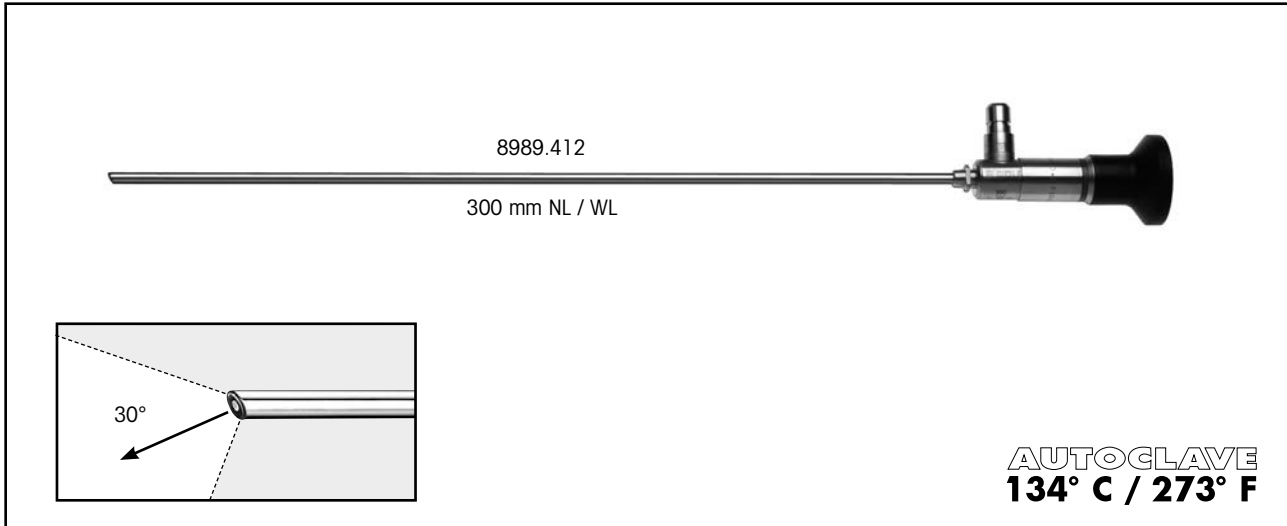

2

**PANOVIEW PLUS telescope, Ø 4 mm,**  
30° ..... 8989.412

**PANOVIEW PLUS-Optik, Ø 4 mm,**  
30° ..... 8989.412

*Recommended light cable:*

**Fiber light cable set** Ø 3.5 mm, 2300 mm long  
consisting of:

Fiber light cable (80663523), adapter projector-side (8095.07) and  
adapter endoscope-side (809509) ..... 806635231  
(for maximum light transmission)

*Accessories:*

**Rerocessing basket**  
(L x W x H) 471 x 59 x 54 mm ..... 38021.111

*Empfohlenes Lichtleitkabel:*

**Fiber Lichtleiter Set**, Ø 3,5 mm, 2300 mm lang  
bestehend aus:



Fiber Lichtleiter (80663523), Adapter projektorseitig (8095.07) und  
Adapter endoskopseitig (809509) ..... 806635231  
(für maximale Lichttransmission)

*Zubehör:*

**Aufbereitungskorb**  
(L x B x H) 471 x 59 x 54 mm ..... 38021.111

*Diagnostic CO<sub>2</sub> Hysteroscope*  
*Sheath 10.5 Fr. / Ø 3.5 mm*  
*for telescope 2.7 mm, 30°*

Diagnostik-CO<sub>2</sub>-Hysteroskop-  
Schaft 10,5 Charr. / Ø 3,5 mm  
für Optik 2,7 mm, 30°



			
	Schaft / Sheath	NL / WL	Typen / Types
 <b>Schaft für Hysteroskop 10,5CH</b> <i>Sheath for hysteroscope 10.5FR</i>	10.5 Charr. / Fr. Ø 3.5 mm	255 mm	<b>8985.11</b>
<b>Handgriff für Hysteroskop</b> <i>Handle for hysteroscope</i>			<b>8986.251</b>

*Continuous-Irrigation Diagnostic  
Hysteroscope Sheath 12 Fr., oval  
for telescope 2.7 mm, 30°*

*Diagnostik-Dauerspül-  
Hysteroskop-Schaft 12 Charr., oval  
für Optik 2,7 mm, 30°*

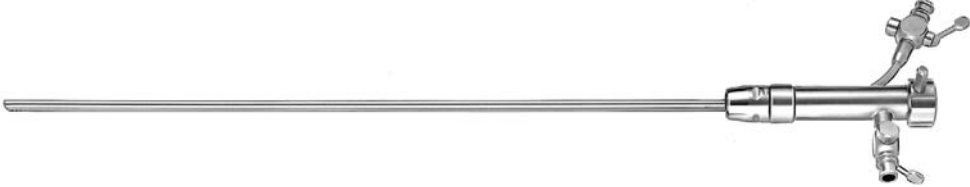
3





	Schaft / Sheath	Arbeitskanal / Working channel	NL / WL	Typen / Types
 Schaft für Hysteroskop 12CH <i>Sheath for hysteroscope 12FR</i>	12 Charr. / Fr.	3 Charr. / Fr.	245 mm	<b>8974.121</b>
Handgriff für Hysteroskop <i>Handle for hysteroscope</i>				<b>8986.251</b>

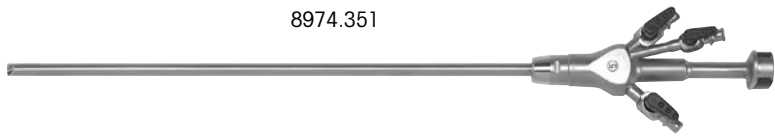

**OptiFLOW™ Continuous-Flow**  
**Operating sheath 5.5 mm**  
 for telescope 2.7 mm, 12° and 30°

**OptiFLOW™ Highflow-Dauerspül-**  
**Operations-Schaft 5,5 mm**  
 für Optik 2,7 mm, 12° und 30°

 <p>8974.351</p>				
	Schaft / Sheath	Arbeitskanal / Working channel	NL / WL	Typen / Types
 <p><b>Schaft für Hysteroskop 16,5CH</b>  <i>Sheath for hysteroscope 16.5FR</i></p>	16.5 Charr. / Fr. Ø 5.5 mm	5 Charr. / Fr.	219 mm	<b>8974351</b>
<p><b>Handgriff für Hysteroskop</b>  <i>Handle for hysteroscope</i></p>				<b>8986.251</b>

3

also:

**PANOVIEW telescope, Ø 2.7 mm,**  
 12° ..... 8974.412  
 30° ..... 8974.402

hierzu:

**PANOVIEW Optik, Ø 2,7 mm,**  
 12° ..... 8974.412  
 30° ..... 8974.402

Recommended light cable:

**Fiber light cable bndl,** Ø 2.5 mm, 2.3 m long consisting of:  
 Fiber light cable (80662523), adapter projector-side (8095.07) and  
 adapter endoscope-side (809509)..... 806625231  
 (for maximum light transmission)

For sterilising:

**RIWO-SYSTEM-TRAY**  
 400 x 60 x 200 mm (W x H x D)  
 incl. lid and peg mat set ..... 38201.486

empfohlenes Lichtleitkabel:

**Fiber Lichtleiter kpl,** Ø 2,5 mm, 2,3 m lang bestehend aus:  
 Fiber Lichtleiter (80662523), Adapter projektorseitig (8095.07) und  
 Adapter endoskopseitig (809509)..... 806625231  
 (für maximale Lichttransmission)

Zur Aufbereitung:

**RIWO-SYSTEM-TRAY**  
 400 x 60 x 200 mm (B x H x T)  
 inkl. Deckel und Noppenmatten-Set ..... 38201.486

*Diagnostic CO<sub>2</sub> Hysteroscope*  
*Sheath 15 Fr.*  
*for telescope 4 mm, 30°*



Diagnostik-CO<sub>2</sub>-Hysteroskop-  
Schaff 15 Charr.  
für Optik 4 mm, 30°

by Lindemann

nach Lindemann





3

	Schaff / Sheath	NL / WL	Typen / Types
 <p><b>Schaff für Hysteroskop 15CH</b> mit distalen Längsschlitz <b>Sheath for hysteroscope 15 FR</b> with openings at the distal tip</p>	15 Charr. / Fr.	255 mm	<b>8989.151</b>
<p><b>Handgriff für Hysteroskop</b> <b>Handle for hysteroscope</b></p>			<b>8986.251</b>

*Continuous-Irrigation Diagnostic  
Hysteroscope Sheath 15 Fr., oval  
for telescope 4 mm, 30°*

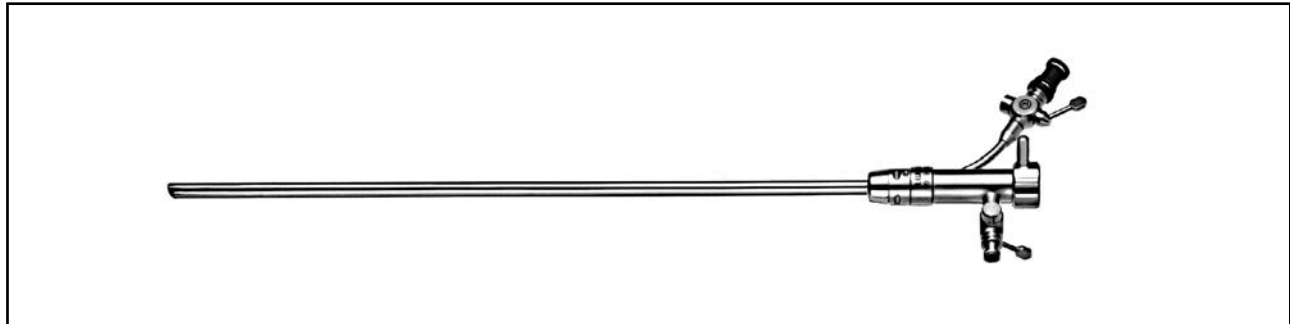
*Diagnostik-Dauerspül-  
Hysteroskop-Schaft 15 Charr., oval  
für Optik 4 mm, 30°*



	Schaft / Sheath	Arbeitskanal / Working channel	NL / WL	Typen / Types
 <p><b>Schaft für Hysteroskop 15CH</b> mit zwei Luer-Lock-Schlauchteilen (886.00) und Gummikappe (88.005) <b>Sheath for hysteroscope 15 FR</b> with Luer tube connections (886.00) and rubber cap (88.005)</p>	15 Charr. / Fr.	3 Charr. / Fr.	230 mm	<b>8989.031</b>
<p><b>Handgriff für Hysteroskop</b> <b>Handle for hysteroscope</b></p>				<b>8986.251</b>

4

Use of flexible auxiliary instruments possible in inlet channel

Anwendung von flexiblen Hilfsinstrumenten bis 3 Charr. über den Zulaufkanal möglich

*Continuous-Irrigation Operating  
Hysteroscope Sheath 21 Fr.  
for telescope 4 mm, 30°*

*Operations-Dauerspül-  
Hysteroskop-Schaft 21 Charr.  
für Optik 4 mm, 30°*

by Gallinat

8988.031



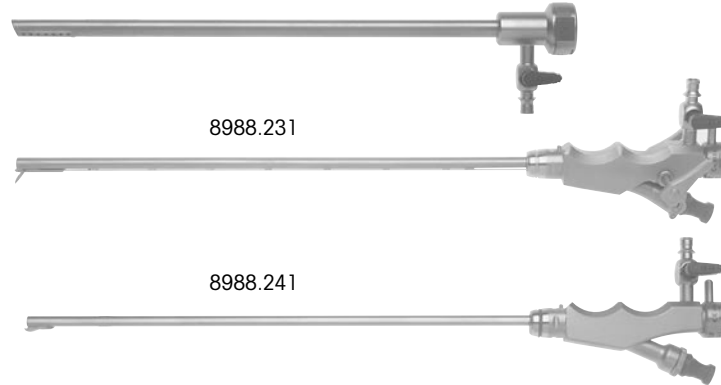

nach Gallinat



8988.231



8988.241

4

	Schaft / Sheath	Arbeitskanal / Working channel	NL / WL	Typen / Types
 <p><b>Außenschaft für Hysteroskop 21CH</b> mit abgeschrägtem distalem Ende und drehbarem Ablaufhahn, sowie Schnellverschluss <b>Outer sheath for hysteroscope 21FR</b> with oblique distal tip, swivel outlet tap and fast locking connector</p>	21 Charr. / Fr.		204 mm	<b>8988.031</b>
 <p><b>Obturator für Hysteroskop AD 5mm</b> speziell für 8988.031 <b>Obturator for hysteroscope OD 5mm</b> specially for 8988.031</p>				<b>8988.131</b>
 <p><b>Arbeitseinsatz für Hysteroskop 21CH</b> mit Auslenk-Hebel und Zulaufhahn, sowie automatisches Ventil für Arbeitskanal, mit Dichtmembran (89.101) <b>Working insert for hysteroscope 21FR</b> with deflection lever, inlet tap and automatic valve for working channel, with sealing membrane (89.101)</p>		7 Charr. / Fr.		<b>8988.231</b>
 <p><b>Arbeitseinsatz für Hysteroskop 21CH</b> mit Rampe und Zulaufhahn, sowie automatisches Ventil für Arbeitskanal, mit Dichtmembran (89.101) <b>Working insert for hysteroscope 21FR</b> with ramp, inlet tap and automatic valve for working channel, with sealing membrane (89.101)</p>		7 Charr. / Fr.		<b>8988.241</b>

**Compact Hysteroscope**  
3.8 mm, 30°

**Kompakt-Hysteroskop**  
3,8 mm, 30°

				
<p><b>AUTOCLAVE</b> <b>134° C / 273° F</b></p>				
	Schaft / Sheath	Arbeitskanal / Working channel	NL / WL	Typen / Types
 <p><b>Hysteroskop kpl</b> bestehend aus: Hysteroskop 30° (8986402) und Gummikappe "RIWO", rot (VE=10 ST, 88.01) <b>Hysteroscope bndl</b> consisting of: Hysteroscope 30° (8986402) and rubber cap "RIWO", red (PACK=10 PCS, 88.01)</p>	Ø 3.8 mm	5 Charr. / Fr.	217 mm	<b>89864021</b>
<p><b>Handgriff für Hysteroskop</b> <b>Handle for hysteroscope</b></p>				<b>8986.251</b>

5

- Compact and ergonomic system with atraumatic instrument tip
- Exceptional image quality in a smaller design
- Continuous irrigation via separate inlet and outlet system for optimum viewing conditions
- Use of auxiliary instruments up to 5 Fr. via straight working channel

- Außergewöhnliche Bildqualität in einem kleineren Design
- Kompaktes und ergonomisches System mit atraumatischer Instrumentenspitze
- Dauerspülung über getrenntes Zu- und Ablaufsystem gewährleistet optimale Sichtverhältnisse
- Anwendung von Instrumenten bis 5 Charr. über geraden Arbeitskanal

Recommended light cable:

**Fiber light cable bndl**, Ø 2.5 mm, 2.3 m long  
consisting of:

Fiber light cable (80662523), adapter projector-side (8095.07) and adapter endoscope-side (809509) ..... 806625231  
(for maximum light transmission)

Empfohlenes Lichtleitkabel:

**Fiber Lichtleiter kpl**, Ø 2,5 mm, 2,3 m lang  
bestehend aus:

Fiber Lichtleiter (80662523), Adapter projektorseitig (8095.07) und Adapter endoskopseitig (809509) ..... 806625231  
(für maximale Lichttransmission)

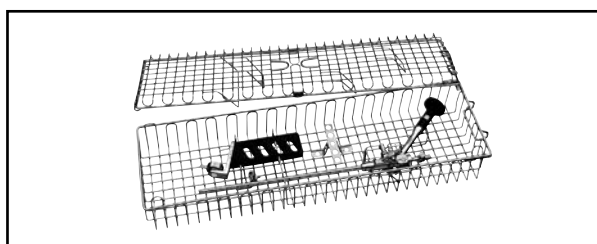

**Aufbereitungskorb**



Maße (B x L x H): 131,5 x 471,5 x 74 mm ..... 38044.111

**Reprocess basket**

dimensions (W x L x H): 131.5 x 471.5 x 74 mm ..... 38044.111

**Compact Hysteroscope**  
5 mm, 20°

**Kompakt-Hysteroskop**  
5 mm, 20°

by Grochmal		nach Grochmal		
				
<p><b>AUTOCLAVE</b> <b>134° C / 273° F</b></p>				
	Schaft / Sheath	Arbeitskanal / Working channel	NL / WL	Typen / Types
  <b>Hysteroskop, 20°</b> <i>Hysteroscope, 20°</i>	Ø 5 mm	5 Charr. / Fr.	217 mm	<b>8986.401</b>
<b>Handgriff für Hysteroskop</b> <i>Handle for hysteroscope</i>				<b>8986.251</b>

6

- Compact and ergonomic system
  - small outer dimensions - large-lumen straight working channel
- Brilliant image and high light transmission with the PANOVIEW PLUS telescope and large field of view
- Round profile
  - easy introduction usually without dilatation
  - better seal
- Continuous irrigation via separate inlet and outlet system for optimum viewing conditions
- Use of auxiliary instruments up to 5 Fr.

Recommended light cable:

**Fiber light cable bndI**, Ø 2.5 mm, 2.3 m long consisting of:

Fiber light cable (80662523), adapter projector-side (8095.07) and adapter endoscope-side (809509) ..... 806625231 (for maximum light transmission)

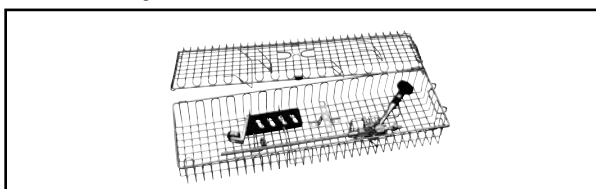

- Kompaktes und ergonomisches System
  - kleiner Außendurchmesser - großlumiger, gerader Arbeitskanal
- Brillante und lichtstarke PANOVIEW Plus-Optik mit großem Bildwinkel
- Rundes Profil
  - leichtes Einführen meist ohne Dilatation
  - bessere Abdichtung
- Dauerspülung über getrenntes Zu- und Ablaufsystem gewährleistet optimale Sichtverhältnisse
- Anwendung von Hilfsinstrumenten bis 5 Charr.

Empfohlenes Lichtleitkabel:

**Fiber Lichtleiter kpl**, Ø 2,5 mm, 2,3 m lang bestehend aus:

Fiber Lichtleiter (80662523), Adapter projektorseitig (8095.07) und Adapter endoskopseitig (809509) ..... 806625231 (für maximale Lichttransmission)

**Aufbereitungskorb**

Maße (B x L x H): 131,5 x 471,5 x 74 mm ..... 38044.111

**Reprocess basket**

dimensions (W x L x H): 131.5 x 471.5 x 74 mm ..... 38044.111





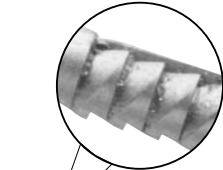
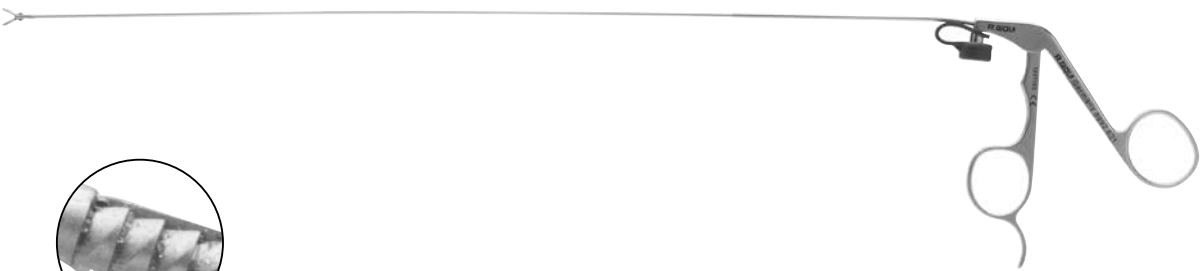

*Rigid Forceps 7 Fr.*

Starre Zange 7 Charr.

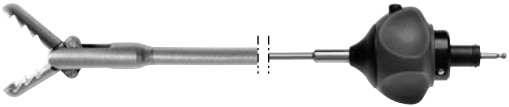
			
<p><b>Starre Präparierzange,</b> Maulteil innen und außen gerieft und zusätzliche Schneidekante <b>Rigid Preparation forceps,</b> grooved inner and outer surfaces of jaws and additional cutting edge</p>	<p>Charr. / Fr.</p> <p>7</p>	<p>NL / WL</p> <p>371 mm</p>	<p>Type / Type</p> <p>8992.621</p>

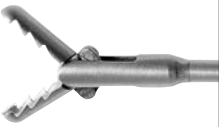
**Forceps and Scissors**  
micro modular system **HySafe**

**Zangen und Scheren**  
Kleinmodulares System **HySafe**

Maulteil mit Schaft / Jaw insert with sheath						Griff mit Überlastschutz Handle with overload protection		<b>Komplett-Instrument</b> • Maulteil • Griff Complete instrument • Insert with sheath • Handle  Typen / Types	
		Einsatz- empfehlung Recommended fields of application	Typen / Types	Charr. / Fr.	NL / WL				
<b>Greifzange kpl</b> mit Hechtmaul			8642.6508	5	340	8083.001		8642.6502	
<b>Grasping forceps bndl</b> with alligator jaws			8992.6308	7	310			8992.6302	
<b>Greifzange kpl,</b> -Löffel <b>Grasping forceps bndl,</b> -spoon			8642.6008	5	340			8642.6002	
<b>Schere kpl</b> <b>Scissors bndl</b>			8642.6818	5	340			8642.6812	
<b>PE-Zange kpl</b> <b>Biopsy forceps bndl</b>			8642.6318	5	340			8642.6312	
<b>Hakenschere kpl</b>  <b>Hooked scissors bndl</b>			8992.6408*	7	310			8992.6402*	

\* on request



\* auf Anfrage



*Flexible Forceps 3 Fr.*



Flexible Zangen 3 Charr.



	Charr. / Fr.	NL / WL	Typen / Types
 <b>Flexible Probe-Exzisionszange</b> <i>Flexible biopsy forceps</i>	3	380 mm	<b>829.131</b>
 <b>Flexible Greifzange</b> <i>Flexible grasping forceps</i>	3	380 mm	<b>828.131</b>

*BipoTrode*  
*1.6 mm / 5 Fr. Bipolar Electrode*

*BipoTrode*  
*1,6 mm / 5 Charr. Bipolar-Elektrode*

		
	NL / WL	Typen / Types
 <b>BipoTrode</b> <b>Elektrode bipolar</b> <b>Electrode bipolar</b>	360 mm	<b>823005</b>



- For precise dissection, preparation and coagulation using saline desension solutions, also for use in laparoscopy (e.g. in combination with trocar sleeve 8309.172 with trocar 8309.121)
- Small diameter of 5 Fr. allows use with hysteroscopes
- Made of semiflexible stainless steel it is suitable for use with curved working channels and ideal for use through the straight working channels of the compact R. WOLF hysteroscopes
- Robust and ergonomic handle
- Autoclavable and reusable

- Zur Dissektion, Präparation und Koagulation in der Hysteroskopie, auch in der Laparoskopie einsetzbar (passend z.B. zu Trokarhülse 8309.172 mit Trokar 8309.121)
- Sehr filigrane Abmessungen zur Anwendung durch klassische Hysteroskope mit 5 Charr. Arbeitskanal
- Durch Verwendung semielastischen Stahls sowohl durch gerade als auch durch schräg zulaufende Arbeitskanäle anwendbar
- Stabiler und ergonomischer Handgriff für einfaches Handling
- Autoklavierbar und somit wiederverwendbar

Bipolar-Pinzettenanschlusskabel siehe Seite / *Bipolar tweezers connecting cable see page E 144.*



*Electrodes  
monopolar*

Elektroden  
monopolar

			
	Charr. / Fr.	NL / WL	Typen / Types
 <b>Koagulations-Elektrode mono</b> <i>Coagulation electrode mono</i>	6	400 mm	<b>823.06</b>
 <b>Nadel-Elektrode mono</b> <i>Needle electrode mono</i>	5	420 mm	<b>824.05</b>

For Cervix and Uterus



Für Portio und Uterus

	NL / WL	Type / Type
 <p><b>Uterusgreifzange</b> nach Pozzi, zum Anhängen der Portio <b>Uterus grasping forceps</b> by Pozzi, for grasping the cervix</p>	92 mm	<b>8370.25</b>
 <p><b>Uterusgreifzange</b> nach Gimpelson <b>Uterus grasping forceps</b> by Gimpelson</p>	242 mm	<b>8371.10</b>
 <p><b>Uterusgreifzange</b> nach Saarges, Ø 6,5 mm zum Fixieren und Elevieren des Uterus <b>Uterus grasping forceps</b> by Saarges Ø 6,5 mm for fixation and elevation of the uterus</p>	100 mm	<b>8370.00</b>

11

*For Cervix and Uterus*

Für Portio und Uterus

<p>for fixation, elevation as well as hydro and chromopertubation of the uterus</p>		<p>zum Fixieren, Elevieren sowie zur Hydro- und Chromopertubation des Uterus</p>	
			
	NL / WL	Typen / Type	
 <p><b>Uteruskatheter</b> nach Sellheim, Ø 4,0 mm <b>Uterine catheter</b> by Sellheim, Ø 4.0 mm</p>	42 mm	<b>8368.00*</b>	

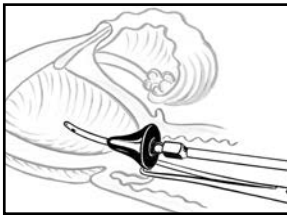
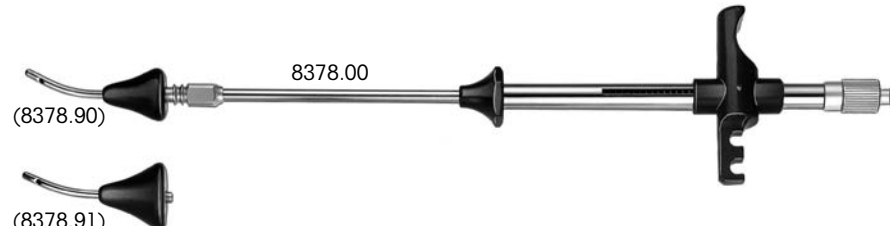
<p>for fixation, elevation as well as hydro and chromopertubation of the uterus</p>		<p>zum Fixieren, Elevieren sowie zur Hydro- und Chromopertubation des Uterus</p>	
			
	NL / WL	Typen / Type	
<p><b>Intrauterinsonden kpl</b> bestehend aus: Intrauterinsonde nach Cohen (8378.00) mit federndem Zangenhalter, 1 kleinen (8378.90) und 1 großen (8378.91) Portio-Kegelansatz, Luer-Lock-Schlauchteil (886.00)</p> <p><b>Intrauterine probes bndl</b> consisting of: Intrauterine probe by Cohen (8378.00) with spring-mounted forceps holder, 1 small (8378.90) and 1 large (8378.91) cervical cone, luer lock tube fitting (886.00)</p>	32 mm	<b>8378001*</b>	

\* also:  
**Uterus grasping forceps** by Pozzi, WL 92 mm ..... 8370.25

\* hierzu:  
**Uterusgreifzange** nach Pozzi, NL 92 mm ..... 8370.25





# PRINCESS

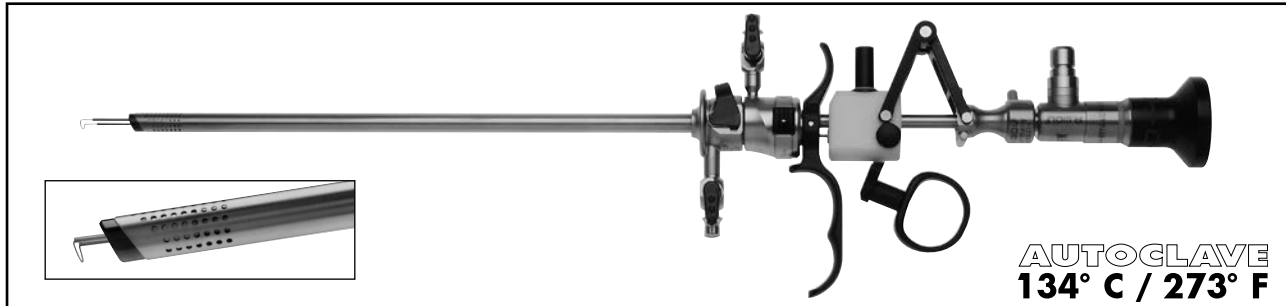

Petit Resectoscope including  
E-line & S(a)line System

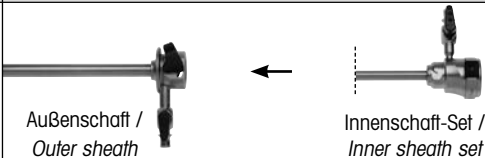
# PRINCESS

Petit Resectoscope including  
E-line & S(a)line System



Charr., Kennfarbe Fr., colour code	distales Ende distal tip	Schäfte, Innenschaff mit distaler Keramikisolation Sheaths, inner sheath with distal ceramic insulation	Obturator Obturator	Sichtobturator Viewing obturator	Elektroden Electrodes
<b>Schäfte</b> Sheaths					
<b>7 mm</b> <b>21 Charr. / Fr.</b> schwarz / black		<b>8653.021</b>	<b>8653.18</b>	<b>865319</b>	siehe Seite see page E 124 / E 125
		<b>8653.018</b> (19 Charr. / Fr.)			

Arbeits-Element Working element	Griff-Varianten Handle type	schneidend cutting action	Type Type
 Schnitt erfolgt durch Federdruck Spring-assisted cutting action	offen / open	passiv / passive	<b>8653.224</b>
 Schnitt erfolgt gegen Federdruck Manual cutting action with spring-assisted release	offen / open	aktiv / active	<b>8653204</b>

Arbeitseinsatz Working insert	für Hilfsinstrumente auxiliary instruments	Type Type
	bis 7 Charr. up to 7 Fr.	<b>8653284</b>

Optiken Telescopes	Ø	Blickrichtung Viewing direction	Type Type
	2.7 mm	12°	<b>8974.412</b> 

**Accessories:**

**Fiber light cable bndl.**, Ø 2.5 mm, 2.3 m long consisting of:  
Fiber light cable (80662523), adapter projector-side (8095.07) and  
adapter endoscope-side (809509) ..... 806625231  
For sterilising: **RIWO-SYSTEM-TRAY**..... 38201.486

**Zubehör:**

**Fiber Lichtleiter kpl.**, Ø 2,5 mm, 2,3 m lang bestehend aus:  
Fiber Lichtleiter (80662523), Adapter projektorseitig (8095.07) und  
Adapter endoskopseitig (809509) ..... 806625231  
Zur Aufbereitung: **RIWO-SYSTEM-TRAY** ..... 38201.486

HF-Anschlusskabel siehe Seite / HF connecting cable see page E 145.







# PRINCESS

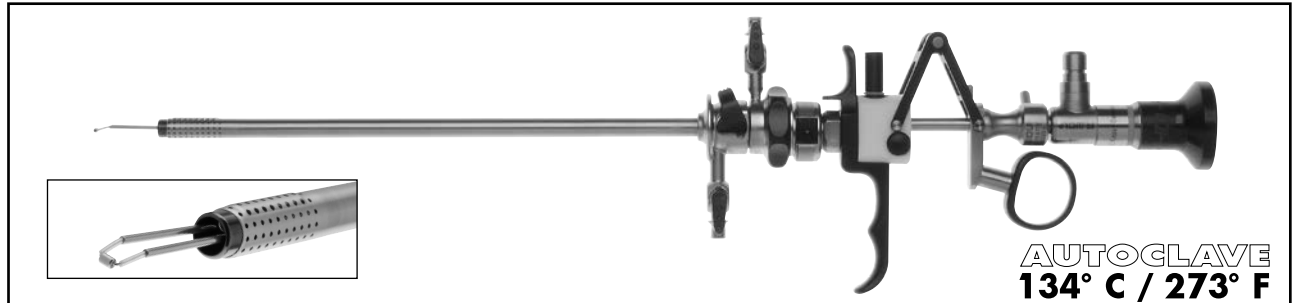

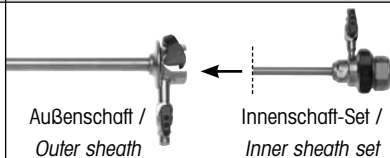
Petit Resectoscope including  
E-line & S(a)line System, rotatable

# PRINCESS

Petit Resectoscope including  
E-line & S(a)line System, rotierbar



Charr., Kennfarbe Fr., colour code	distales Ende distal tip	Schäfte, Innenschaff mit distaler Keramikisolation Sheaths, inner sheath with distal ceramic insulation	Innenschaff-Set Inner sheath set		Obturator Obturator	Sichtobturator Viewing obturator	Elektroden Electrodes	
<b>Schäfte Sheaths</b>			bestehend aus consisting of					
		Außenschaff / Outer sheath	Innenschaff-Set / Inner sheath set	Innenschaff Inner sheath	Drehbares Verbindungsstück Rotatable connector			
<b>7 mm 21 Charr. / Fr. schwarz / black</b>		<b>8653022</b>	<b>8653019</b> (19 Charr. / Fr.)	<b>86530191</b>	<b>86533643</b>	<b>8653.18</b>	<b>865319</b>	siehe Seite see page E 124 / E 125
<b>8 mm 24,5 Charr. / Fr. grün / green</b>		<b>8655.334</b>	<b>8655.344</b> (22.5 Charr. / Fr.)	<b>8655.3441</b>	<b>8654.3642</b>	<b>8654.16</b>	-	

Arbeits-Element Working element	Griff-Varianten Handle type	schneidend cutting action	Type Type
 Schnitt erfolgt durch Federdruck Spring-assisted cutting action	offen / open	passiv / passive	<b>8653.224</b>
 Schnitt erfolgt gegen Federdruck Manual cutting action with spring-assisted release	offen / open	aktiv / active	<b>8653204</b>

Arbeitseinsatz Working insert	für Hilfsinstrumente auxiliary instruments	Type Type
	bis 7 Charr. up to 7 Fr.	<b>8653284</b>

Optik Telescopes	Ø	Blickrichtung Viewing direction	
	2.7 mm	12°	<b>8974.412</b> 

**Accessories:**

**Fiber light cable bndI**, Ø 2.5 mm, 2.3 m long consisting of:  
Fiber light cable (80662523), adapter projector-side (8095.07) and  
adapter endoscope-side (809509) ..... 806625231  
For sterilising: **RIWO-SYSTEM-TRAY**..... 38201.486

**Zubehör:**

**Fiber Lichtleiter kpl**, Ø 2,5 mm, 2,3 m lang bestehend aus:  
Fiber Lichtleiter (80662523), Adapter projektorseitig (8095.07) und  
Adapter endoskopseitig (809509) ..... 806625231  
Zur Aufbereitung: **RIWO-SYSTEM-TRAY** ..... 38201.486



HF-Anschlusskabel siehe Seite / HF connecting cable see page E 145.

## Electrodes

for PRINCESS Resectoscopes,  
2.7 mm telescope, 12°

## Elektroden

für PRINCESS Resektoskope,  
Optik 2,7 mm, 12°

für Dauerspül-Schaft for continuous-irrigation sheath	Bügel Loop		7 mm / 21 Charr. / Fr.	8 mm / 24,5 Charr. / Fr.
<b>Schneide-Elektrode, monopolar</b> <b>Cutting electrode, monopolar</b> 	0,3 mm	Gabel Branches	rot / red	blau / blue
			<b>8653.131</b>	<b>8653.132</b>
<b>Rollen-Elektrode, monopolar</b> <b>Roller electrode, monopolar</b> 	-	Gabel Branches	rot / red	
			<b>8653.02</b>	
<b>Haken-Elektrode, monopolar und bipolar</b> <b>Hook electrode, monopolar and bipolar</b> 	-	Gabel Branches	rot / red	
			<b>865303</b>	
		Stiel Stem	blau / blue	blau / blue

12







**Protective sterilization sleeve**  
for a maximum of 5 resection or vaporisation electrodes, or urethrotome knives,  
outer Ø 20 mm, length 328 mm ..... 8428.901

**Sterilisations-Schutzhülse**  
zur Aufnahme von max. 5 Resektions- oder Vaporisations-Elektroden, oder Urethrotommesser,  
Außen-Ø 20 mm, Länge 328 mm ..... 8428.901



*Disposable Electrodes*  
für PRINCESS Resektoskope,  
2.7 mm telescope, 12°





Einmalgebrauch-Elektroden  
für PRINCESS Resektoskope,  
Optik 2,7 mm, 12°

für Dauerspül-Schaft for continuous-irrigation sheath	Bügel Loop		7 mm / 21 Charr. / Fr.	8 mm / 24,5 Charr. / Fr.
<b>Schneide-Elektrode</b> , bipolar, VE= 3 ST, einzeln steril verpackt <b>Cutting electrode</b> , bipolar, PACK= 3 PCS., packed singly, sterile 	0.3 mm	Gabel Branches	transparent / transparent	transparent / transparent
			<b>4653.1313</b>	<b>4653.1323</b>
<b>Rollen-Elektrode</b> , bipolar, VE= 3 ST, einzeln steril verpackt <b>Roller electrode</b> , bipolar, PACK= 3 PCS., packed singly, sterile 	-	Gabel Branches	transparent / transparent	
			<b>4653.023</b>	
<b>BIVAP-Elektrode</b> , bipolar, VE= 3 ST, einzeln steril verpackt <b>BIVAP electrode</b> , bipolar, PACK= 3 PCS., packed singly, sterile 	-	Gabel Branches	blau / blue	blau / blue
			<b>46530213</b>	<b>46530243</b>
<b>Haken-Elektrode</b> , monopolar und bipolar, VE= 3 ST, einzeln steril verpackt <b>Hook electrode</b> , monopolar and bipolar, PACK= 3 PCS., packed singly, sterile 	-	Gabel Branches	transparent / transparent	
			<b>4653033</b>	
		Stiel Stem	blau / blue	

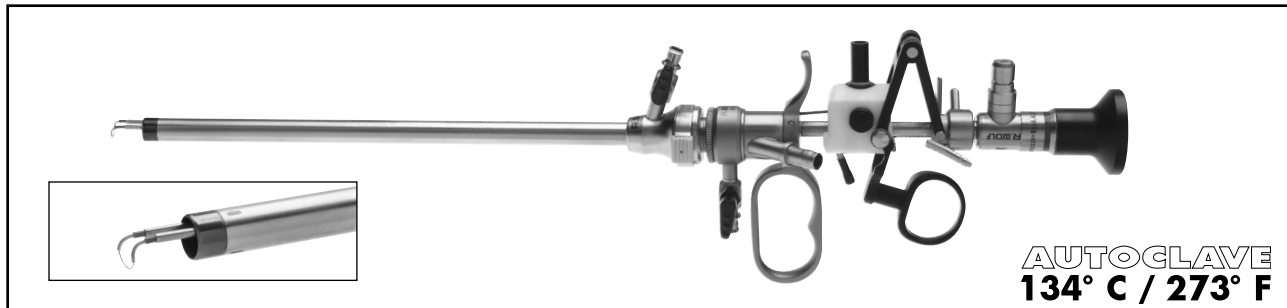
**RESECTION MASTER**  
with automatic chip aspiration

**RESECTION MASTER**  
mit automatischer Chip-Absaugung

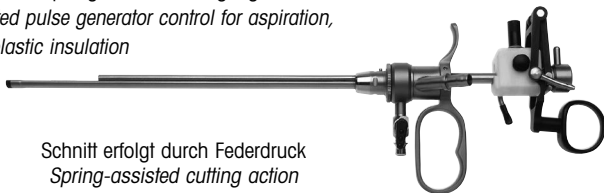

Charr., Kennfarbe Fr., colour code	distales Ende distal tip	Dauerspül-Außenschaft, gerade, "E-line" Material: Titan / Edelstahl Continuous-flow outer sheath, straight, "E-line" material: titanium / stainless steel	Obturator Obturator	Elektroden Electrodes
<b>Schaft</b> <b>Sheath</b>				
9 mm 27 Charr. / Fr. schwarz / black		<b>8659.071</b>	<b>8659.175</b>	siehe Seite see page E 127 / E 128

Arbeits-Element, "E-line" Working element, "E-line"	Griff-Varianten Handle type	schneidend cutting action	Type Type
mit integriertem Impulsgeber für Absaugung im Kanal, mit distaler Kunststoff-Isolation with integrated pulse generator control for aspiration, with distal plastic insulation    Schnitt erfolgt durch Federdruck Spring-assisted cutting action	geschlossen / closed	passiv / passive	<b>8659.2351</b>

Optik Telescope	Ø	Blickrichtung Viewing direction	
	3.3 mm	30°	<b>8656.422</b> 

**Sterile single use tube set** for RESECTION PUMP 2228  
consisting of: Control tube, irrigation tube with non-return valve, chip aspiration tube with non-return valve and pump tube  
(10 PCS., individually sterile packed) ..... 4170.2228

Recommended light cable:

**Fiber light cable bndl.**, Ø 2.5 mm, 2.3 m long, consisting of:  
Fiber light cable (80662523), adapter projector-side (8095.07) and  
adapter endoscope-side (809509) ..... 806625231

For sterilising:

**RIWO-SYSTEM-TRAY**  
400 x 60 x 200 mm (W x H x D)  
inkl. lid and peg mat set ..... 38201.486

**Steriles Schlauchset** zum Einmalgebrauch an RESECTION PUMP 2228  
bestehend aus: Steuerschlauch, Spülschlauch mit Rückschlagventil,  
Chip- absaugeschlauch mit Rückschlagventil und Pumpenschlauch  
(10 Stück, einzeln steril verpackt) ..... 4170.2228

Empfohlenes Lichtleitkabel:

**Fiber Lichtleiter kpl.**, Ø 2,5 mm, 2,3 m lang, bestehend aus:  
Fiber Lichtleiter (80662523), Adapter projektorseitig (8095.07) und  
Adapter endoskopseitig (809509) ..... 806625231

Zur Aufbereitung:

**RIWO-SYSTEM-TRAY** zur Aufnahme des gesamten Instrumentariums  
400 x 60 x 200 mm (B x H x T)  
inkl. Deckel und Noppenmatten-Set ..... 38201.486



HF Anschlusskabel siehe Seite / HF connecting cable see page E 143.

## Electrodes

for RESECTION MASTER  
with automatic chip aspiration

## Elektroden

für RESECTION MASTER  
mit automatischer Chip-Absaugung

für Dauerspül-Schaft for continuous-irrigation sheath	Bügel Loop		27 Charr. / Fr.
<b>Schneide-Elektrode, monopolar</b> <b>Cutting electrode, monopolar</b> 	0.3 mm	Gabel Branches	rot / red
			<b>8659.161</b>
<b>Vaporisations-Elektrode, tonnenförmig, monopolar</b> <b>Vaporisation electrode, barrel-shaped, monopolar</b> 	-	Gabel Branches	blau / blue
			<b>8659.162</b>
<b>Haken-Elektrode, monopolar und bipolar</b> <b>Hook electrode monopolar and bipolar</b> 	-	Gabel Branches	rot / red
			<b>8659163</b>
		Stiel Stem	rot / red





**Protective sterilization sleeve**  
for a maximum of 5 resection or vaporisation electrodes, or urethrotome knives,  
outer Ø 20 mm, length 328 mm ..... 8428.901

**Sterilisations-Schutzhülse**  
zur Aufnahme von max. 5 Resektions- oder Vaporisations-Elektroden, oder Urethrotommesser,  
Außen-Ø 20 mm, Länge 328 mm ..... 8428.901

*Disposable Electrodes*  
for RESECTION MASTER  
with automatic chip aspiration

Einmalgebrauch-Elektroden  
für RESECTION MASTER  
mit automatischer Chip-Absaugung

für Dauerspül-Schaft for continuous-irrigation sheath	Bügel Loop		27 Charr. / Fr.
<b>Schneide-Elektrode</b> , bipolar, VE = 3 Stück, einzeln steril verpackt <b>Cutting electrode</b> , bipolar, PACK= 3 PCS., packed singly, sterile 	0.25 mm	Gabel Branches	bleu / azul
			<b>4659.1613</b>
	-	Stiel Stem	bleu / azul
			<b>4659.1623</b>
<b>Koagulations-Elektrode</b> , bipolar, VE = 3 Stück, einzeln steril verpackt <b>Coagulation electrode</b> , bipolar, PACK= 3 PCS., packed singly, sterile 		Gabel Branches	bleu / azul
			<b>4659.1623</b>
		Stiel Stem	bleu / azul

## RESECTION PUMP 2228

Microprocessor controlled high-power chip aspiration pump with clear LCD display

## RESECTION PUMP 2228

microprozessorgesteuerte Hochleistungs-Chip-  
absaugpumpe mit übersichtlicher LCD-Anzeige



A new, extremely effective pump unit with integrated pulse aspiration facilitates automatic chip aspiration. The very short aspiration pulse that can be adjusted in 3 levels, restricts the loss of fluid to a minimum, so that collapse of the cavity is effectively prevented.

Ein neues, höchst effektives Pumpenaggregat mit integrierter Impulsabsaugung ermöglicht die automatische Chip-Absaugung. Der extrem kurze Absaugimpuls beschränkt den Flüssigkeitsverlust auf ein (in 3 Stufen vorwählbares) Minimum, wodurch ein Kollabieren des cavums wirkungsvoll verhindert wird.

### RESECTION PUMP 2228

#### suction pump bndl

consisting of:

RESECTION PUMP 2228 (2228.001), bottle holder cpl. (64030.125 and 64031.381), tube set RESECTION PUMP 2228, steril (4170.2228 / PACK=10 PCS), overflow protection/bacteria filter (2228.901 / for single use, PACK=10 PCS), hygiene-filter,steril (2221.901 / PACK=10 PCS), chip collecting container (2228.801) with tube insert (2228.802), secretion container 2000 ml, autoclavable (8170.6551) with lid (8170.6552), sound absorber (35100.115 / PACK= 3 PCS), connection tube (8170.6554) and power cable (2440.03) ..... 2228.0011

also:

**Unit cart**, 560 x 560 x 800 mm,  
4 antistatic castors, 2 with brake ..... 31115.001

### RESECTION PUMP 2228

#### Saugpumpe kpl

bestehend aus:

RESECTION PUMP 2228 (2228.001), Flaschenhalter kpl. (64030.125 und 64031.381), Schlauchset RESECTION PUMP 2228, steril (4170.2228 / VE=10 ST), Überlaufschutz/Bakterienfilter (2228.901 / Einmalartikel, VE=10 ST), Hygienefilter, steril (2221.901 / VE=10 ST), Chip-Auffangbehälter (2228.801) mit Rohreinsatz (2228.802), Sekretbehälter 2 L, autoklavierbar (8170.6551) mit Deckel (8170.6552), Schalldämpfer (35100.115 / VE=3 ST), Verbindungsschlauch (8170.6554) und Netzkabel (2440.03) ..... 2228.0011

hierzu:

**Gerätewagen**, 560 x 560 x 800 mm,  
4 antistatische Rollen, 2 feststellbar ..... 31115.001

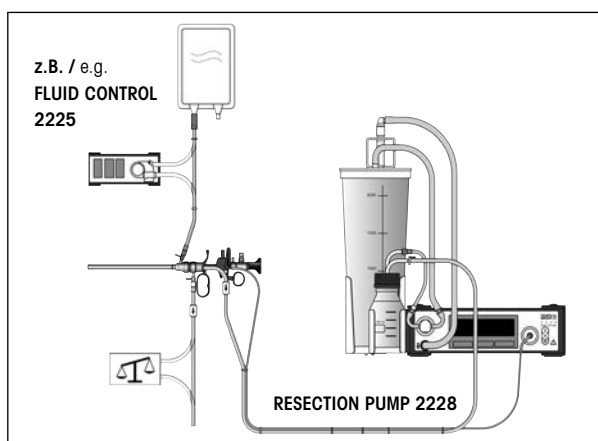

Das RESECTION PUMP System kann mit der Spülpumpe FLUID CONTROL 2225 kombiniert werden.

The RESECTION PUMP System can be combined with Irrigation Pump FLUID CONTROL 2225.



**Resectoscope bipolar**  
 for 4 mm Telescope, 30°, 12°  
 with continuous-irrigation double-sheath system  
 for resection in saline







**Resektoskop bipolar**  
 für Optik 4 mm, 30°, 12°  
 mit Dauerspül-Doppelschaff-System  
 zur Resektion in Kochsalzlösung

Arbeitselement, Innenschaff und Optik drehen sich im Außenschaff  
 Working elements, inner sheath and telescope are rotating in the outer sheath

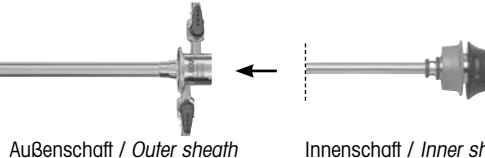

**AUTOCLAVE**  
**134° C / 273° F**

Charr., Kennfarbe Fr., Colour code	distales Ende distal tip	Schäfte, Innenschaff mit distaler Keramikisolation Sheaths, inner sheath with distal ceramic insulation	Obturator Obturator	Sichtobturator Viewing obturator	Elektroden Electrodes
<b>Schäfte</b> Sheaths		 Außenschaff / Outer sheath      Innenschaff / Inner sheath			
<b>22 / 24 Charr.</b> grün / green		<b>8675424</b>	<b>8675322</b>	<b>8673022</b>	<b>8673122</b>
					siehe Seite / see page E 132 / E 133

**Arbeits-Elemente** siehe Rückseite  
**Working elements** see overleaf



Optiken Telescopes	∅	Blickrichtung Viewing direction	mit gesteigerter Bildgröße und Objektfeld with enlarged image and objective field	
	4 mm	30°	<b>8654.422</b>	
		12°	<b>8654.431</b>	

Recommended light cable:

**Fiber light cable bndl**, ∅ 2.5 mm, 2.3 m long

consisting of:

Fiber light cable (80662523), adapter projector-side (8095.07) and  
 adapter endoscope-side (809509) ..... 806625231

(for maximum light transmission)

Empfohlenes Lichtleitkabel:

**Fiber Lichtleiter kpl**, ∅ 2,5 mm, 2,3 m lang

bestehend aus:

Fiber Lichtleiter (80662523), Adapter projektorseitig (8095.07) und  
 Adapter endoskopseitig (809509) ..... 806625231

(für maximale Lichttransmission)

Bipolar-Anschlusskabel siehe Seite / Bipolar connecting cable see page E 144.

## Working Elements

for **Shark** resectoscope bipolar  
4 mm telescope, 30°, 12°

## Arbeits-Elemente

für **Shark** Resektoskop bipolar  
Optik 4 mm, 30°, 12°

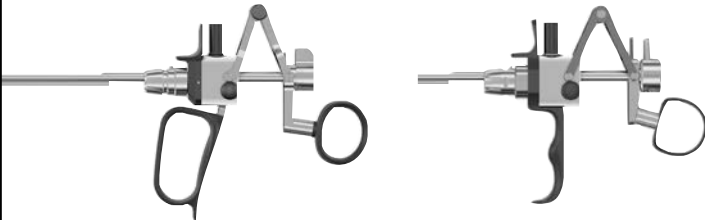
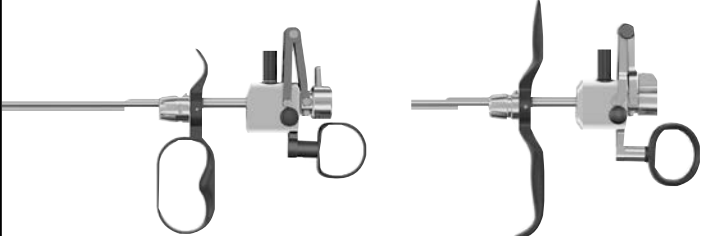
	Griff-Varianten <i>Handle type</i>	schneidend <i>Cutting action</i>	Type <i>Type</i>
 Schnitt erfolgt gegen Federdruck <i>Manual cutting action with spring-assisted release</i>	offen / <i>open</i>	aktiv / <i>active</i>	<b>8680.204</b>
	geschlossen / <i>closed</i>	aktiv / <i>active</i>	<b>8680.205</b>
 Schnitt erfolgt durch Federdruck <i>Spring-assisted cutting action</i>	offen / <i>open</i>	passiv / <i>passive</i>	<b>8680.224</b>
	geschlossen / <i>closed</i>	passiv / <i>passive</i>	<b>8680.225</b>

Thumb ring with large inner diameter..... 15008.159

Daumenring mit größerem Innendurchmesser..... 15008.159

Rubber caps, pack of 5, black ..... 8880  
(for sealing the electrode clamping on the working element)



Gummikappe, VE=5 Stück, schwarz ..... 8880  
(zum Abdichten der Elektrodenklemmung am Arbeitselement)

## Electrodes

for **Shark** resectoscopes bipolar,  
4 mm telescope, 30°, 12°

## Elektroden

für **Shark** Resektoskope bipolar,  
Optik 4 mm, 30°, 12°

für Dauerspül-Schaft for continuous-irrigation sheath	Bügel Loop		22 / 24 Charr. / Fr.
<b>Schneide-Elektrode, rund</b> <b>Cutting electrode, round</b> 	0.3 mm	Gabel Branches	blau / blue
		Stiel Stem	gelb / yellow
<b>Haken-Elektrode</b> <b>Hook electrode</b> 	-	Gabel Branches	blau / blue
		Stiel Stem	gelb / yellow
<b>Koagulations-Elektrode</b> <b>Coagulating electrode</b> 	-	Gabel Branches	blau / blue
		Stiel Stem	gelb / yellow

12



### Protective sterilization sleeve

for a maximum of 5 resection or vaporisation electrodes, or urethrotome knives,  
outer Ø 20 mm, length 328 mm ..... 8428.901

### Sterilisations-Schutzhülse

zur Aufnahme von max. 5 Resektions- oder Vaporisations-Elektroden, oder Urethrotommesser,  
Außen-Ø 20 mm, Länge 328 mm ..... 8428.901





## Disposable Electrodes

für **Shark** resectoscopes bipolar,  
4 mm telescope, 30°, 12°

## Einmalgebrauch-Elektroden

für **Shark** Resektoskope bipolar,  
Optik 4 mm, 30°, 12°

für Dauerspül-Schaft for continuous-irrigation sheath	Bügel Loop		22 / 24 Charr. / Fr.
<b>Schneide-Elektrode, rund,</b> VE= 3 ST, einzeln steril verpackt <b>Cutting electrode, round,</b> PACK= 3 PCS., packed singly, sterile  	0.25 mm	Gabel Branches	blau / blue
			<b>4622.2533</b>
	0.3 mm	Stiel Stem	blau / blue
			<b>4622.1333</b>
<b>Koagulations-Elektrode,</b> VE= 3 ST, einzeln steril verpackt <b>Coagulating electrode,</b> PACK= 3 PCS., packed singly, sterile  	-	Gabel Branches	blau / blue
			<b>4623.0243</b>
<b>BIVAP-Elektrode, bipolar,</b> VE= 3 ST, einzeln steril verpackt <b>BIVAP electrode, bipolar,</b> PACK= 3 PCS., packed singly, sterile  	-	Stiel Stem	blau / blue
			<b>46300223</b>
		Gabel Branches	blau / blue
			<b>46300223</b>
		Stiel Stem	blau / blue







**Resectoscope monopolar**  
for 4 mm Telescope, 30°, 12°  
with continuous-irrigation double-sheath system

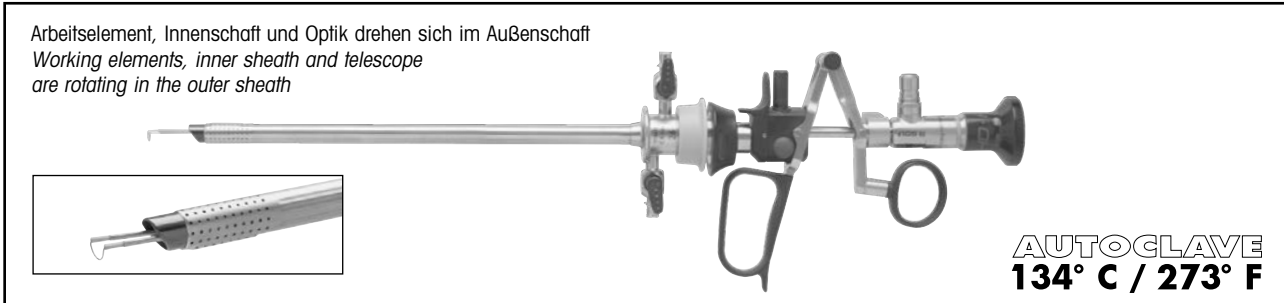

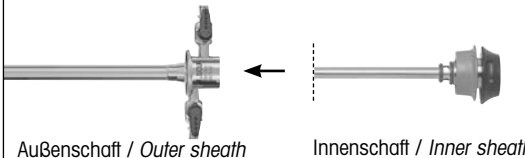
**Resektoskop monopolar**  
für Optik 4 mm, 30°, 12°  
mit Dauerspül-Doppelschaft-System



Charr., Kennfarbe <i>Fr., Colour code</i>	distales Ende <i>distal tip</i>	Schäfte, Innenschaft mit distaler Keramikisolation <i>Sheaths, inner sheath with distal ceramic insulation</i>	Obturator <i>Obturator</i>	Sichtobturator <i>Viewing obturator</i>	Elektroden <i>Electrodes</i>
<b>Schäfte</b> <i>Sheaths</i>		 Außenschaft / <i>Outer sheath</i> Innenschaft / <i>Inner sheath</i>			
<b>22 / 24 Charr.</b> grün / <i>green</i>		<b>8675424</b>	<b>8675322</b>	<b>8673022</b>	<b>8673122</b>
					siehe Seite / <i>see page</i> E 136 / E 137



Optiken <i>Telescopes</i>	∅	Blickrichtung <i>Viewing direction</i>	mit gesteigerter Bildgröße und Objektfeld <i>with enlarged image and objective field</i>	
	4 mm	30°	<b>8654.422</b>	
		12°	<b>8654.431</b>	

Recommended light cable:

**Fiber light cable bndI**, ∅ 2.5 mm, 2.3 m long

consisting of:

Fiber light cable (80662523), adapter projector-side (8095.07) and  
adapter endoscope-side (809509) ..... 806625231

(for maximum light transmission)

Empfohlenes Lichtleitkabel:

**Fiber Lichtleiter kpl**, ∅ 2,5 mm, 2,3 m lang

bestehend aus:

Fiber Lichtleiter (80662523), Adapter projektorseitig (8095.07) und  
Adapter endoskopseitig (809509) ..... 806625231

(für maximale Lichttransmission)

HF-Anschlusskabel siehe Seite / *HF connecting cable see page* E 143.

## Working Elements

for **Shark** resectoscopes monopolar  
4 mm telescope, 30°, 12°

## Arbeits-Elemente

für **Shark** Resektoskope monopolar  
Optik 4 mm, 30°, 12°

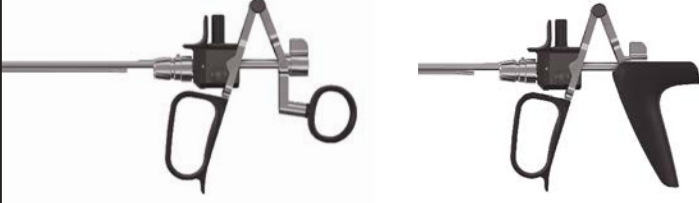
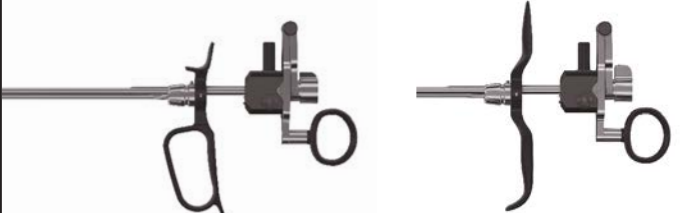
	Griff-Varianten Handle type	schneidend cutting action	Type Type
 Schnitt erfolgt gegen Federdruck Manual cutting action with spring-assisted release	geschlossen / closed	aktiv / active	<b>8674205</b>
	geschlossen mit Komfort-Daumenauflage closed with comfort thumb rest	aktiv / active	<b>8674234</b>
 Schnitt erfolgt durch Federdruck Spring-assisted cutting action	geschlossen / closed	passiv / passive	<b>8674225</b>
	offen / open	passiv / passive	<b>8674224</b>

\* with comfort thumb rest

Thumb ring with large inner diameter ..... 15008.159

Rubber caps, pack of 5, red ..... 8874  
(for sealing the electrode clamping on the working element)







\* mit Komfort-Daumenauflage

Daumenring mit größerem Innendurchmesser ..... 15008.159

Gummikappe, VE=5 Stück, rot ..... 8874  
(zum Abdichten der Elektrodenklemmung am Arbeitselement)

**Electrodes**  
for **Shark** resectoscopes monopolar,  
4 mm telescope, 12°, 30°

**Elektroden**  
für **Shark** Resektoskope monopolar,  
Optik 4 mm, 30°, 12°

für Dauerspül-Schaft for continuous-irrigation sheath	Bügel Loop	Stiel Stem	22 / 24 Charr. / Fr.
<b>Schneide-Elektrode</b> <i>Cutting electrode</i> 	0.35 mm	Gabel Branches	grün / green
		Stiel Stem	<b>86782235</b> dunkelgrau / dark gray
<b>Koagulations-Elektrode</b> <i>Coagulating electrode</i> 	Rolle Roller	Gabel Branches	grün / green
		Stiel Stem	<b>86782201</b> dunkelgrau / dark gray
<b>Koagulations-Elektrode</b> <i>Coagulating electrode</i> 	Kugel Ball	Gabel Branches	grün / green
		Stiel Stem	<b>86782202</b> dunkelgrau / dark gray
<b>Koagulations-Elektrode</b> <i>Coagulating electrode</i> 	Knopf Button	Gabel Branches	grün / green
		Stiel Stem	<b>86782203</b> dunkelgrau / dark gray
<b>Messer-Elektrode</b> <i>Knife electrode</i> 	-	Gabel Branches	grün / green
		Stiel Stem	<b>86782204</b> dunkelgrau / dark gray
<b>Haken-Elektrode</b> <i>Hook electrode</i> 	-	Gabel Branches	grün / green
		Stiel Stem	<b>86782205</b> dunkelgrau / dark gray
<b>Wing-Elektrode</b> <i>Wing electrode</i> 	-	Gabel Branches	grün / green
		Stiel Stem	<b>86782206</b> dunkelgrau / dark gray



**AUTOGLAVE**  
**134° C / 273° F**

**Protective sterilization sleeve** for a maximum of  
5 resection or vaporisation electrodes, or urethrotome knives,  
outer Ø 20 mm, length 328 mm ..... 8428.901







**Sterilisations-Schutzhülse** zur Aufnahme von  
max. 5 Resektions- oder Vaporisations-Elektroden, oder Urethrotommesser,  
Außen-Ø 20 mm, Länge 328 mm ..... 8428.901

## Disposable Electrodes

für **Shark** Resektoskope monopolar,  
4 mm telescope, 12°, 30°

## Einmalgebrauch-Elektroden

für **Shark** Resektoskope monopolar,  
Optik 4 mm, 30°, 12°

für Dauerspül-Schaft for continuous-irrigation sheath	Bügel Loop	Stiel Stem	Für Schaftgrößen in Charr. / for sheath sizes in Fr. 22/24
<b>Schneide-Elektrode</b> VE= 10 ST, einzeln steril verpackt <b>Cutting electrode</b> PACK= 10 PCS., packed singly, sterile 	Schlinge Loop 0.35 mm	Gabel Branches	grün / green <b>46782235</b>
		Stiel Stem	transparent / transparent
	Schlinge Loop 0.25 mm	Gabel Branches	grün / green <b>46782225</b>
		Stiel Stem	transparent / transparent
<b>Koagulations-Elektrode</b> VE= 5 ST, einzeln steril verpackt <b>Coagulating electrode</b> PACK= 5 PCS., packed singly, sterile 	Rolle Roller	Gabel Branches	grün / green <b>46782201</b>
		Stiel Stem	transparent / transparent
<b>Koagulations-Elektrode</b> VE= 5 ST, einzeln steril verpackt <b>Coagulating electrode</b> PACK= 5 PCS., packed singly, sterile 	Kugel Sphere	Gabel Branches	grün / green <b>46782202</b>
		Stiel Stem	transparent / transparent
<b>Koagulations-Elektrode</b> VE= 5 ST, einzeln steril verpackt <b>Coagulating electrode</b> PACK= 5 PCS., packed singly, sterile 	Knopf Button	Gabel Branches	grün / green <b>46782203</b>
		Stiel Stem	transparent / transparent
<b>Messer-Elektrode</b> VE= 5 ST, einzeln steril verpackt <b>Knife electrode</b> PACK= 5 PCS., packed singly, sterile 	Messer Knife	Gabel Branches	grün / green <b>46782204</b>
		Stiel Stem	transparent / transparent
<b>Haken-Elektrode</b> VE= 5 ST, einzeln steril verpackt <b>Hook electrode</b> PACK= 5 PCS., packed singly, sterile 	Haken Hook	Gabel Branches	grün / green <b>46782205</b>
		Stiel Stem	transparent / transparent

12

## Flexible Fibre-Hysteroscope 2.5 mm / 7.5 Fr.

## Flexibles Fiber-Hysteroskop 2,5 mm / 7,5 Charr.

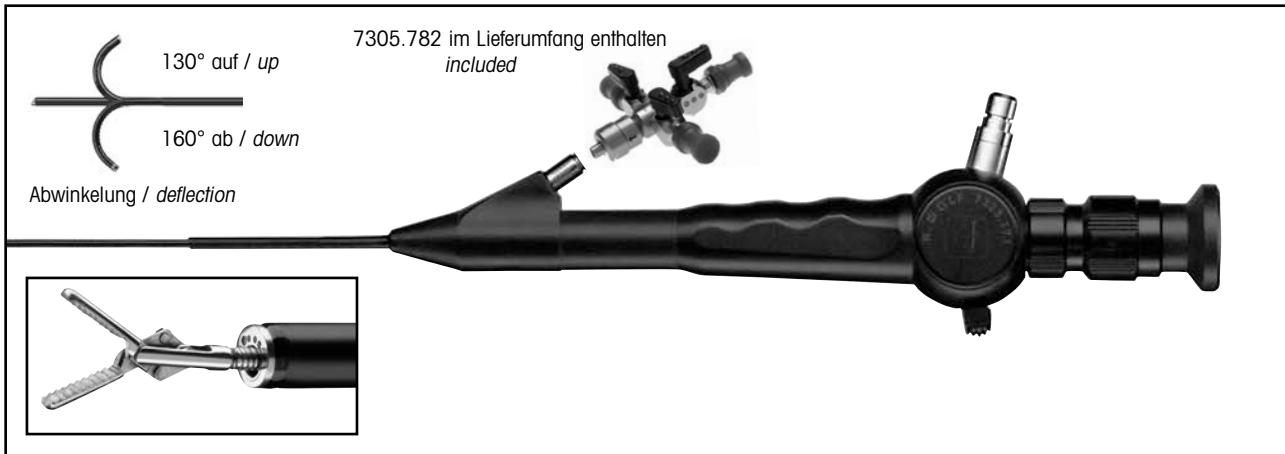

- Optimum ratio between sheath and instrument diameter - 2.5 / 1.2 mm with excellent image quality
- Easy to insert with stepless sheath over the entire working length
- Active deflection of 130° up / 160° down with extra passive deflection
- 0° position of the instrument tip can be clearly felt on the control lever
- Reduced weight and ergonomic design for optimal handling and less strain on the operator
- Immersible and suitable for gas sterilisation
- Optimales Verhältnis von Schaft- zu Sondenkanal-Durchmesser 2,5 / 1,2 mm bei exzellenter Bildqualität
- Gutes Einführungsverhalten durch stufenlosen Schaft auf gesamter Nutzlänge
- Aktive Abwinkelung von 130° auf / 160° ab mit zusätzlicher passiver Abwinkelung
- Spürbare Positionsraste am Steuerhebel zeigt die 0°-Stellung der gestreckten Instrumentenspitze an
- Gewichtsreduzierte Bauweise und ergonomisches Design für optimales Handling und ermüdungsfreies Arbeiten
- Einleg- und gassterilisierbar

	im Set enthaltenes Hysteroskop included in set hysteroscope	Außen-Ø Outer Ø	Sondenkanal Instrument channel	Nutzlänge Working length	Type Type
<b>Fiber-Hysteroskop kpl</b> bestehend aus: Flexibles Fiber-Hysteroskop, Ansatz mit Einführungshahn (7305.782), flexible PE-Zange (7223.60), Dichtigkeitstester (163.903), Gassteril-Ventil (163.904), Reinigungsbürste (7321.911), Koffer  <b>Fibre hysteroscope bundle</b> consisting of: flexible fibre hysteroscope, instrument port (7305.782), flexible biopsy forceps (7223.60), water tightness tester (163.903), gas sterilisation valve (163.904), cleaning brush (7321.911), case	7325.122	2.5 mm 7.5 Charr. / Fr.	1.2 mm 3.6 Charr. / Fr.	200 mm	<b>7325.1221</b>

hierzu / also: <b>Fiber Lichtleiter kpl</b> , Ø 1,6 mm bestehend aus: Fiber Lichtleiter (80661618), Adapter projektorseitig (8095.07) und Adapter endoskopseitig (809509) <b>Fiber light cable bndl</b> , Ø 1.6 mm consisting of: Fiber light cable (80661618), adapter projector-side (8095.07) and adapter endoscope-side (809509)				1800 mm	<b>806616181</b>
--	--	--	--	---------	------------------

auf Wunsch / on request: <b>Flexible Fasszange</b> <b>Flexible grasping forceps</b>		1 mm 3 Charr. / Fr.		640 mm	<b>7223.65</b>
---	--	------------------------	--	--------	----------------

## FLUID CONTROL 2225

Suction and irrigation pump

## FLUID CONTROL 2225

Saug- und Spülpumpe



core

### Performance

- 1800 ml/min irrigation performance
- 2000 ml/min suction performance
- Continuous irrigation flow  
Even in small sized instruments
- NEW: Integrated vacuum function**  
Fast exchange of fluid for optimum visualization conditions
- 60% higher irrigation performance compared to previous models

### Diagnosis

- Simple instrument selection using touch display
- "Plug-and-Play" by using instrument presets
- Pressure-controlled indication - Optimally adjusted pressure setting
- Optimum irrigation performance also with small- sized instruments
- Endoscopes from other manufacturers  
can be used with standard adjustment
- Perioperative permanent maximum power

### Resection

- Pressure-controlled indication - Optimally adjusted pressure setting
- Permanent display and monitoring of the fluid deficit
- Acoustic warning signal if the permitted quantity is exceeded

### FLUID CONTROL 2225

#### Irrigation pump for HYS / URO / LAP

Fluid management for irrigation of irrigation fluids

FLUID CONTROL 2225 ..... 2225001

FLUID CONTROL 2225, incl. power cable ..... 22250011

#### Balancing module

fluid management for fluid balancing in combination  
with FLUID CONTROL 2225,

mobile stands with integrated load cells and accommodation

for up to 4 irrigation fluid bags ..... 2225023

### Leistung

- 1800 ml/min Spüleleistung
- 2000 ml/min Absaugleistung
- Kontinuierlicher Spülstrom  
selbst bei dünnlumigen Instrumenten
- NEU: Integrierte Vakuum-Funktion**  
Schneller Flüssigkeitsaustausch für optimale Sichtverhältnisse
- 60% höhere Spüleleistung gegenüber Vorgängermodell

### Diagnostik

- Einfache Instrumenten-Auswahl über Touch-Display
- "Plug-and-Play" durch Instrumenten-Presets
- Druckgeregelte Indikation - Optimal angepasster Druckwert
- Optimale Spüleleistung auch mit dünnlumigen Instrumenten
- Endoskope anderer Hersteller  
können mit Standardeinstellung verwendet werden
- Perioperativ gleichbleibend maximale Leistung

### Resektion

- Druckgeregelte Indikation - Optimal angepasster Druckwert
- Permanente Anzeige und Überwachung des Flüssigkeitsdefizits
- Akustisches Warnsignal bei Überschreitung der zulässigen Menge

### FLUID CONTROL 2225

#### Spülpumpe für HYS / URO / LAP

Fluidmanagement zur Irrigation von Spülflüssigkeiten

FLUID CONTROL 2225 ..... 2225001

FLUID CONTROL 2225, inkl. Netzkabel ..... 22250011

#### Bilanzierungsmodul

Fluidmanagement zur Flüssigkeitsbilanzierung in Kombination  
mit FLUID CONTROL 2225,

Fahrständer mit integrierten Wiegezellen und Aufnahme

für bis zu 4 Spülflüssigkeitsbeutel ..... 2225023

## FLUID CONTROL 2225

### Accessories

**Irrigation tube set**, with piercing connector, 3 m,  
with Y-piece, with Luer lock connector,  
PACK= 10 PCS, sterile, for single use ..... 4171223

**Irrigation tube set**, with Care lock, 3 m,  
PACK= 10 PCS, sterile, for single use ..... 4171224

**Suction-irrigation tube set**,  
3 m, PACK= 10 PCS, sterile, for single use ..... 4171225

**Irrigation tube set**, with piercing connector,  
with Luer lock connection, incl. 10 replacement membranes,  
reusable, 20 x autoclavable ..... 8171223\*

**Tube set** with Y-piece, 5 m  
pack of 10, sterile, for single use ..... 4170.901

**Vacuum tube**,  
silicon, reusable, 20x autoclavable ..... 8170.401\*

**Vacuum tube with filter**, 1.7 m ..... 2206207

**Tube adapter**,  
with Luer lock connector, for suction irrigation handle 8385.901  
and tube set 8171223 or 8170.223,  
reusable ..... 817123\*

**Drain tube**, 3 m  
for suction irrigation handle 8385.901  
reusable ..... 8171402

**Protective filter for gas filtration** for single use ..... 4171.121\*

**Suction container**, 3 l  
incl. mounting bracket, reusable ..... 8170.981

**Suction container**, 3 l  
PACK= 2 PCS, for single use ..... 2215.971

### Wiring accessories

**Patch cable**, RJ45 SFTP,  
cable length 0.5 m ..... 72325378  
cable length 1.0 m ..... 72325429  
cable length 10 m ..... 72325434  
**Plastic cap for network socket**, PACK= 8 PCS ..... 5592105  
**Fuse**, 5 x 20, 3,15 AT, VE= 2 ST ..... 64268.007  
**Power cable**, cable length 2.0 m ..... 2440.03

\* not for U.S. device

## FLUID CONTROL 2225

### Zubehör

**Spülschlauchset** mit Anstechdorn, 3 m  
mit Y-Stück, mit Luer-Lock-Anschluss,  
VE= 10 ST, steril, zum Einmalgebrauch ..... 4171223

**Spülschlauchset** mit Care-Lock, 3 m  
VE= 10 ST, steril, zum Einmalgebrauch ..... 4171224

**Saug-Spülschlauchset** 3 m  
VE= 10 ST, steril, zum Einmalgebrauch ..... 4171225

**Spülschlauchset**, mit Anstechdorn,  
mit Luer-Lock-Anschluss, inkl. 10 Ersatzmembranen,  
wiederverwendbar, 20x autoklavierbar ..... 8171223\*

**Schlauchset** mit Y-Stück, 5 m  
VE= 10 ST, steril, zum Einmalgebrauch ..... 4170.901

**Vakuum-Schlauch**,  
wiederverwendbar, 20x autoklavierbar ..... 8170.401\*

**Vakuum-Schlauch mit Filter**, 1,7 m ..... 2206207

**Schlauchansatz**  
mit Luer-Lock-Anschluss, für Saug-Spül-Handgriff 8385.901  
und Schlauchset 8171223 oder 8170.223,  
wiederverwendbar ..... 817123\*

**Saugschlauch**, 3 m  
für Saug-Spül-Handgriff 8385.901  
wiederverwendbar ..... 8171402

**Schutzfilter zur Gasfiltration** zum Einmalgebrauch ..... 4171.121\*

**Saug-Behälter**, 3 l  
inkl. Halterung, wiederverwendbar ..... 8170.981

**Saug-Behälter**, 3 l  
VE= 2 ST, zum Einmalgebrauch ..... 2215.971

### Verkabelungszubehör

**Patchkabel**, RJ45 SFTP,  
Kabellänge 0,5 m ..... 72325378  
Kabellänge 1,0 m ..... 72325429  
Kabellänge 10 m ..... 72325434  
**Plastikkappe für Netzwerkbuchse**, VE= 8 ST ..... 5592105  
**Sicherung**, 5 x 20, 3,15 AT, VE= 2 ST ..... 64268.007  
**Netzkabel**, Kabellänge 2,0 m ..... 2440.03

\* nicht für US-Gerät



## Technical Data

### FLUID CONTROL 2225

## Technische Daten

### FLUID CONTROL 2225

FLUID CONTROL 2225	
Netzspannungsbereich (V) <i>Mains voltage range (V)</i>	100 - 240 V~
Versorgungsfrequenz (Hz) <i>Supply frequency range (Hz)</i>	50/60 Hz
Leistungsaufnahme <i>Power consumption</i>	Strom (A)      Leistungsaufnahme (VA) <i>Current (A)      Power consumption (VA)</i>
100 V / 60 Hz	1,10 A      110 VA
240 V / 50 Hz	0,50 A      118 VA
Schutzklasse (I, II) <i>Protection class (I, II)</i>	I
Betriebsbedingungen <i>Operating conditions</i>	+10 bis/to +40 °C 30 bis 75 % rel. Luftfeuchtigkeit / <i>a</i> 30 to 75 % rel. humidity 70 bis 106 kPa Luftdruck / 70 to 106 kPa air pressure 3000 m max. Einsatzhöhe über NN / 3000 m max. altitude above sea level for device use
Lager- & Transportbedingungen <i>Storage, transport and shipping conditions</i>	-20 bis/to +60 °C 10 bis 90 % rel. Luftfeuchtigkeit / 10 to 90 % rel. humidity 70 bis 106 kPa Luftdruck / 70 to 106 kPa air pressure
Maximaler Saugunterdruck <i>Maximum suction vacuum</i>	-60 kPa
Einstellbare Werte / Bereiche / Adjustable values/ranges	
Sollfluss-Bereich <i>Nominal flow range</i>	Hysteroskopie / <i>Hysteroscopy</i> : 800 ml/min (max. Flow, nicht einstellbar / <i>max. flow, not adjustable</i> ) Endourologie / <i>Endourology</i> : 10 - 800 ml/min (max. Flow / <i>max. flow</i> ) Laparoskopie / <i>Laparoscopy</i> : 0,1 - 1,8 l/min (max. Flow / <i>max. flow</i> )
Saugleistung <i>Suction power</i>	max. 2 l/min <i>maximum 2 l/min</i>
Ausgangs-Solldruckbereich <i>Starting nominal pressure range</i>	Hysteroskopie / <i>Hysteroscopy</i> : 15 - 200 mmHg Endourologie / <i>Endourology</i> : 15 - 90 mmHg / 20 - 125 cmH <sub>2</sub> O Laparoskopie / <i>Laparoscopy</i> : 370 mmHg (fest eingestellt / <i>not adjustable</i> )
Druck <i>Pressure</i>	0 - 300 mmHg
Defizit / Verbrauch <i>Deficit / consumption</i>	-9990 bis +9990 ml / 0 bis 99,9 l <i>-9990 to +9990 ml / 0 to 99.9 l</i>
Abmessungen (B x H x T) <i>Maximum dimensions (w x h x d)</i>	300 mm x 157 mm x 436 mm
Gewicht <i>Weight</i>	8,8 kg 8.8 kg

## Technical Data

FLUID CONTROL 2225













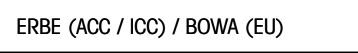



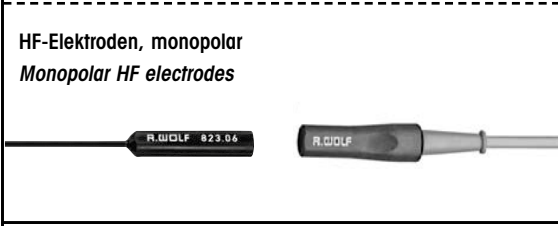

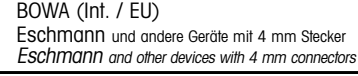
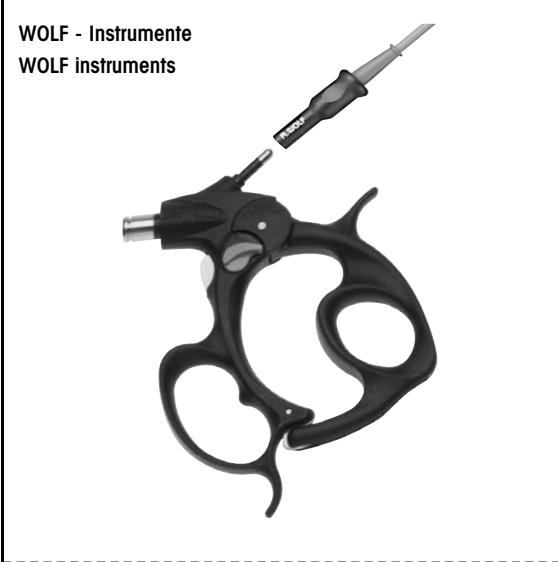

## Technische Daten

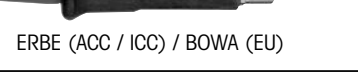
FLUID CONTROL 2225

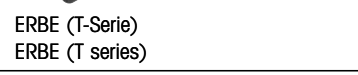
<b>Bilanzierungsmodul / Balancing module</b>	
Betriebsbedingungen <i>Operating conditions</i>	+10 bis/to +40 °C 30 bis 75 % rel. Luftfeuchtigkeit / a 30 to 75 % rel. humidity 70 bis 106 kPa Luftdruck / 70 to 106 kPa air pressure 3000 m max. Einsatzhöhe über NN / 3000 m max. altitude above sea level for device use
Lager- & Transportbedingungen <i>Storage, transport and shipping conditions</i>	-20 bis +60 °C / -20 to +60 10 bis 90 % rel. Luftfeuchtigkeit / 10 to 90 % rel. humidity 70 bis 106 kPa Luftdruck / 70 to 106 kPa air pressure
Maximale Belastung der Behälterwaage <i>Max. load of canister scale</i>	16 kg / 4 Behälter zu jeweils 3 l 16 kg / 4 containers with 3 l each
Maximale Belastung der Beutelwaage <i>Max. load of bag scale</i>	23 kg / 4 Beutel zu jeweils 5 l 23 kg / 4 bags with 5 l each
Abmessungen (B x H x T) <i>Maximum dimensions (w x h x d)</i>	618 mm x 1064 mm x 618 mm

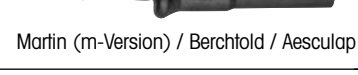

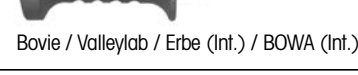

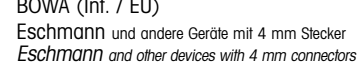



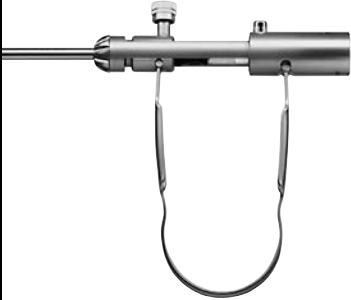

## HF Monopolar Connecting Cables

## HF-Monopolar Anschlusskabel

Anschluss Instrument <i>Connector for instrument</i>	Anschluss Gerät <i>Connector for unit</i>	Länge <i>Length</i>	Typen <i>Types</i>
<p><b>WOLF - Resektoskope</b> <i>WOLF resectoscopes</i></p> 	 ERBE (ACC / ICC) / BOWA (EU)	3 m	<b>815.032</b>
	 ERBE (T-Serie) ERBE (T series)	5 m	<b>815.052</b>
	 ERBE (T-Serie) ERBE (T series)	3 m	<b>815.132</b>
	 ERBE (T-Serie) ERBE (T series)	5 m	<b>815.152</b>
	 Martin (m-Version) / Berchtold / Aesculap	3 m	<b>815.031</b>
	 Martin (m-Version) / Berchtold / Aesculap	5 m	<b>815.051</b>
<p><b>HF-Elektroden, monopolar</b> <i>Monopolar HF electrodes</i></p> 	 Bovie / Valleylab / Erbe (Int.) / BOWA (Int.)	3 m	<b>815.033</b>
	 Bovie / Valleylab / Erbe (Int.) / BOWA (Int.)	5 m	<b>815.053</b>
	 BOWA (Int. / EU) Eschmann und andere Geräte mit 4 mm Stecker <i>Eschmann and other devices with 4 mm connectors</i>	3 m	<b>815.034</b>
 BOWA (Int. / EU) Eschmann und andere Geräte mit 4 mm Stecker <i>Eschmann and other devices with 4 mm connectors</i>	5 m	<b>815.054</b>	
<p><b>WOLF - Instrumente</b> <i>WOLF instruments</i></p> 	 ERBE (ACC / ICC) / BOWA (EU)	3 m	<b>8106.032</b>
	 ERBE (ACC / ICC) / BOWA (EU)	5 m	<b>8106.052</b>
	 ERBE (T-Serie) ERBE (T series)	3 m	<b>8106.132</b>
	 ERBE (T-Serie) ERBE (T series)	5 m	<b>8106.152</b>
	 Martin (m-Version) / Berchtold / Aesculap	3 m	<b>8106.031</b>
	 Martin (m-Version) / Berchtold / Aesculap	5 m	<b>8106.051</b>
<p><b>HF-Elektroden, monopolar</b> <i>Monopolar HF electrodes</i></p> 	 Bovie / Valleylab / Erbe (Int.) / BOWA (Int.)	3 m	<b>8106.033</b>
	 Bovie / Valleylab / Erbe (Int.) / BOWA (Int.)	5 m	<b>8106.053</b>
	 BOWA (Int. / EU) Eschmann und andere Geräte mit 4 mm Stecker <i>Eschmann and other devices with 4 mm connectors</i>	3 m	<b>8106.034</b>
 BOWA (Int. / EU) Eschmann und andere Geräte mit 4 mm Stecker <i>Eschmann and other devices with 4 mm connectors</i>	5 m	<b>8106.054</b>	



## HF Bipolar Connecting Cables

## HF-Bipolar Anschlusskabel

Anschluss Instrument <i>Connector for instrument</i>	Anschluss Gerät <i>Connector for unit</i>	Länge <i>Length</i>	Typen <i>Types</i>	
<p><b>WOLF Bipolar-Zangen</b> <i>WOLF bipolar forceps</i></p> 		3 m	<b>8108.032</b>	
	ERBE (ACC / ICC / T) / BOWA (EU)	5 m	<b>8108.052</b>	
		3 m	<b>8108.033</b>	
	Martin (Int.) / 2 pin Valleylab / BOWA (Int.)	5 m	<b>8108.053</b>	
		3 m	<b>8108.031</b>	
	WOLF / Martin (m-Version) / Berchtold / Aesculap	5 m	<b>8108.051</b>	
		3 m	<b>8108035</b>	
	EMC Dolley	5 m	<b>8108055</b>	
	<p><b>Bipolar-Pinzetten Anschluss</b> <i>Bipolar tweezers connector</i></p> 		3 m	<b>8108.132</b>
		ERBE (ACC / ICC / T) / BOWA (EU)	5 m	<b>8108.152</b>
		3 m	<b>8108.133</b>	
Martin (Int.) / 2 pin Valleylab / BOWA (Int.)		5 m	<b>8108.153</b>	
		3 m	<b>8108.131</b>	
WOLF / Martin (m-Version) / Berchtold / Aesculap		5 m	<b>8108.151</b>	
		3 m	<b>8108135</b>	
EMC Dolley		5 m	<b>8108155</b>	

*HF Connecting Cables*  
for *S(a)line* resectoscopes

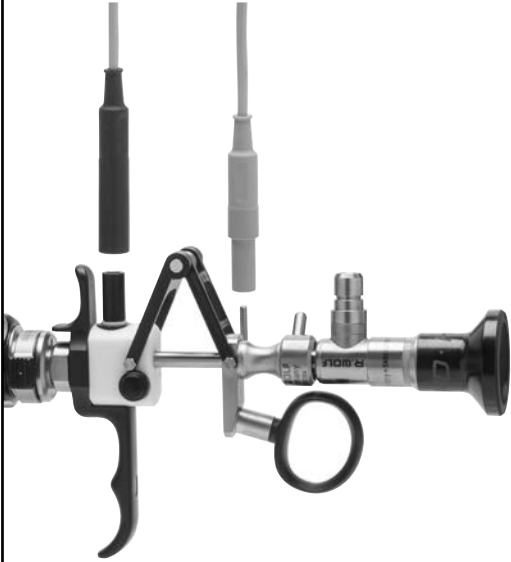
HF Anschlusskabel  
für *S(a)line* Resektoskope

Anschluss Instrument Connector for instrument	Anschluss Gerät Connector for unit	Länge Length	Typen Types
<p><b>WOLF S(a)line-Resektoskope</b> <b>WOLF S(a)line resectoscopes</b></p> 		3 m	<b>8108.232</b>
	ERBE	5 m	<b>8108.252</b>
		3 m	<b>8108.231</b>
	Martin (m-Version)	5 m	<b>8108.251</b>



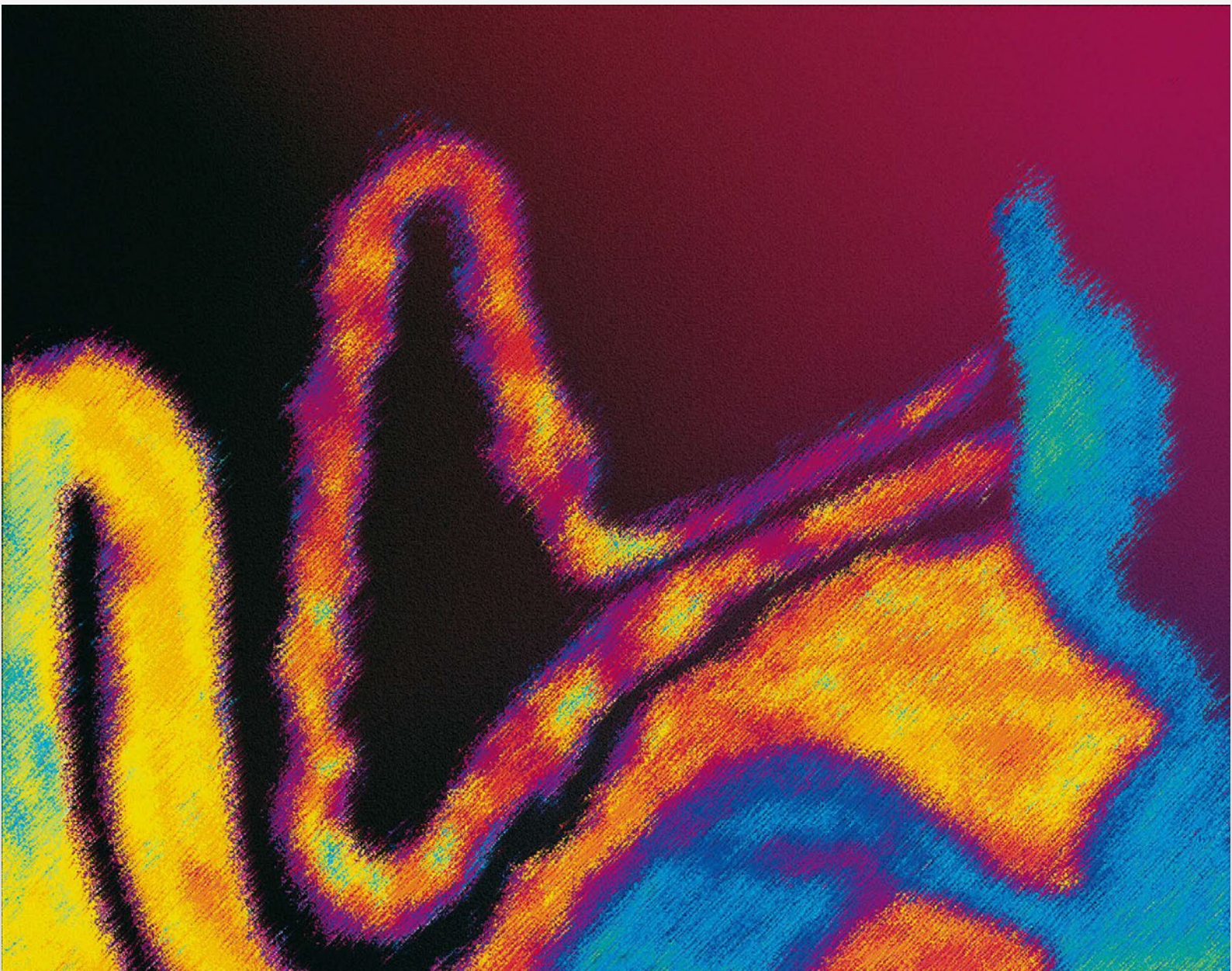

**Interdisziplinäre Anwendungen**

**Cysto-Urethroskopie**

***Interdisciplinary Applications***

***Cysto-Urethroscopy***

## *Interdisciplinary Applications*

## Interdisziplinäre Anwendungen

1

*Cysto-Urethroscope 8650  
for Telescope 4 mm, 0°, 5°, 30°, 70° (TVT)*

2

*Cystoscope 14, 17 Fr., 25°*

3

*Set for transurethral Incontinence Therapy*

*Cysto-Urethroskop 8650  
für Optik 4 mm, 0°, 5°, 30°, 70° (TVT)*

*Cystoskop 14, 17 Charr., 25°*

*Set zur transurethralen Inkontinenz-Therapie*



## Cysto-Urethroscope

### 8650 E-line

for telescope 4 mm, 0°, 12°, 30°, 70°  
and adaptors



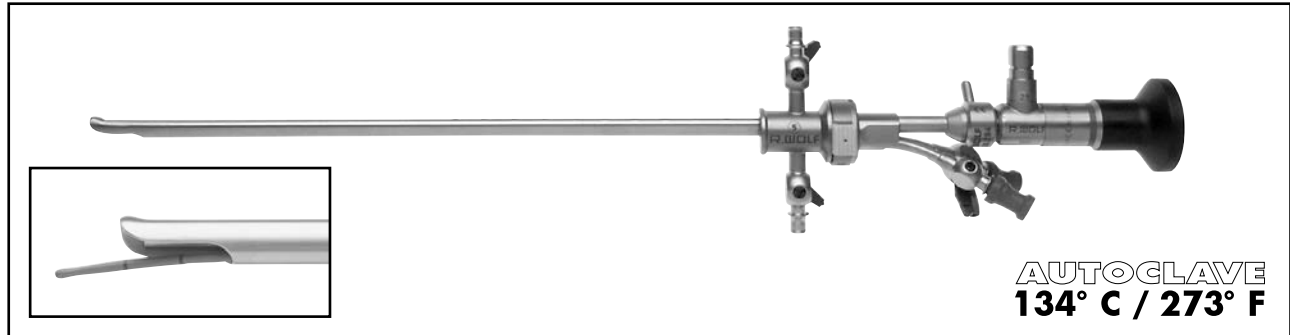

## Cysto-Urethroskop

### 8650 E-line

für Optik 4 mm, 0°, 12°, 30°, 70°  
und Ansätze



1

Schäfte und Obturatoren <i>Sheaths and obturators</i>						Ansätze <i>Adaptors</i>		
								
Schaft inkl. Obturator <i>Sheath incl. obturator</i>	Schaft einzeln <i>Sheath single</i>	Obturator einzeln <i>Obturator single</i>	Charr. <i>Fr.</i>	Kennfarbe <i>Colour code</i>	Durchlass in Charr. <i>Capacity (Fr.)</i>	nur zur Diagnostik <i>only for examination</i>	1 Einführungshahn <i>1 Instrument port</i>	2 Einführungshähne <i>2 Instrument ports</i>
<b>8650.0141</b>	<b>8650.0145</b>	<b>8650.0147</b>	16	gelb <i>yellow</i>	1x5*	<b>8650.254</b>	<b>8650.264</b>	<b>8650.284</b>
<b>8650.0241</b>	<b>8650.0245</b>	<b>8650.0247</b>	17.5	grün <i>green</i>	1x5 oder / or 2x4			
<b>8650.0341</b>	<b>8650.0345</b>	<b>8650.0347</b>	19.5	rot <i>red</i>	1x7 oder / or 2x5			
<b>8650.0441</b>	<b>8650.0445</b>	<b>8650.0447</b>	21	blau <i>blue</i>	1x10 oder / or 2x6			
<b>8650.0541</b>	<b>8650.0545</b>	<b>8650.0547</b>	23	weiß <i>white</i>	1x12 oder / or 2x7			
<b>8650.0641</b>	<b>8650.0645</b>	<b>8650.0647</b>	25	schwarz <i>black</i>	1x15			

\* for urethroscopy (cystoscopy for diagnosis only with adaptor 8650.254)

\* nur urethroskopisch (cystoskopisch nur zur Diagnostik geeignet über Ansatz 8650.254)

Ø	Blickrichtung <i>Viewing direction</i>	Typen <i>Types</i>	PANOVIEW-Optiken <i>PANOVIEW telescopes</i>
4 mm	0°	<b>8650.414</b>	
	12°	<b>8654.431</b>	
	30°	<b>8654.422</b>	
	70°	<b>8650.415</b>	

**HD**  
High Definition

**Accessories:**

**Fiber light cable bndl**, Ø 2.5 mm, 2.3 m long consisting of:  
Fiber light cable (80662523), adapter projector side (8095.07) and  
adapter endoscope side (809509) ..... 80662523 1  
**Reprocess basket**,  
capacity 1 endoscope ..... 38021.111

**Zubehör:**

**Fiber Lichtleiter kpl**, Ø 2,5 mm, 2,3 m lang bestehend aus:  
bestehend aus: Fiber Lichtleiter (80663523), Adapter projektorseitig  
(8095.07) und Adapter endoskopseitig (809509) ..... 80662523 1  
**Aufbereitungskorb**,  
Aufnahmekapazität 1 Endoskop ..... 38021.111

## Cysto-Urethroscope

### 8650 E-line



for telescope 4 mm, 30°, 70°  
and inserts with Albarran deflector

## Cysto-Urethroskop

### 8650 E-line

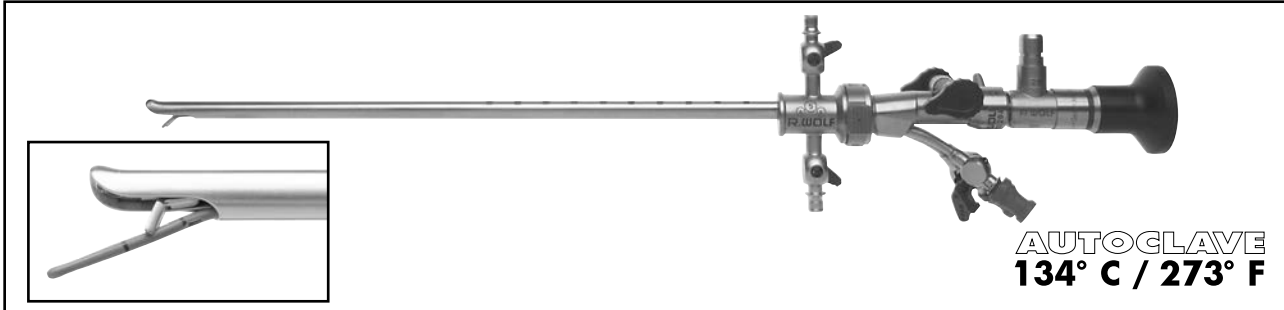
für Optik 4 mm, 30°, 70°  
und Einsätze mit Albarran-Hebel



Schäfte und Obturatoren <i>Sheaths and obturators</i>						Einsätze mit Albarran-Hebel <i>Inserts with Albarran deflector</i>	
							
Schaft inkl. Obturator <i>Sheath incl. obturator</i>	Schaft einzeln <i>Sheath single</i>	Obturator einzeln <i>Obturator single</i>	Charr. <i>Fr.</i>	Kennfarbe <i>Colour code</i>	Durchlass in Charr. <i>Capacity (Fr.)</i>	1 Einführungshahn <i>1 Instrument port</i>	2 Einführungshähne <i>2 Instrument ports</i>
<b>8650.0241</b>	<b>8650.0245</b>	<b>8650.0247</b>	17.5	grün green	1x5 oder / or 2x4	<b>8650.214</b>	<b>8650.204</b>
<b>8650.0341</b>	<b>8650.0345</b>	<b>8650.0347</b>	19.5	rot red	1x7 oder / or 2x5		
<b>8650.0441</b>	<b>8650.0445</b>	<b>8650.0447</b>	21	blau blue	1x10 oder / or 2x6		
<b>8650.0541</b>	<b>8650.0545</b>	<b>8650.0547</b>	23	weiß white	1x12 oder / or 2x7		

Ø	Blickrichtung <i>Viewing direction</i>	Typen <i>Types</i>	PANOVIEW-Optiken <i>PANOVIEW telescopes</i>
4 mm	30°	<b>8654.422</b>	
	70°	<b>8650.415</b>	



**Accessories:**

**Fiber light cable bndl**, Ø 2.5 mm, 2.3 m long  
consisting of: Fiber light cable (80662523),  
adapter projector side (8095.07) and  
adapter endoscope side (809509) ..... 806625231  
**Reprocess basket**,  
capacity 1 endoscope ..... 38021.111

**Zubehör:**

**Fiber Lichtleiter kpl**, Ø 2,5 mm, 2,3 m lang bestehend aus:  
bestehend aus: Fiber Lichtleiter (80663523),  
Adapter projektorseitig (8095.07) und  
Adapter endoskopseitig (809509)..... 806625231  
**Aufbereitungskorb**,  
Aufnahmekapazität 1 Endoskop ..... 38021.111

**Atraumatic  
Compact Cysto-Urethroscopes  
14, 17 Fr., 25°**

**Atraumatische  
Kompakt-Cysto-Urethroscopie  
14, 17 Charr., 25°**

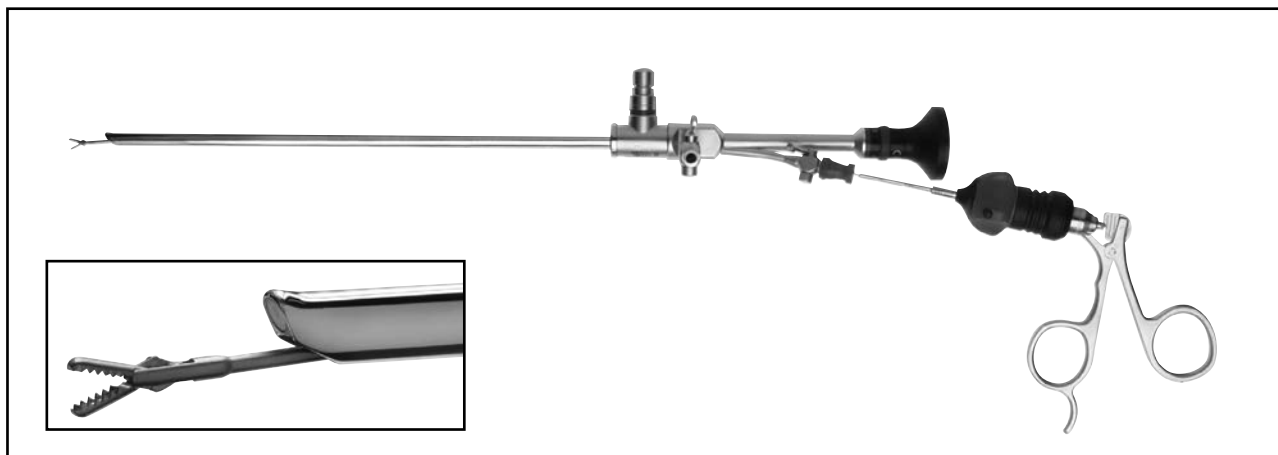

2

**For clinique and practice**

- Outpatient urethro-cystoscopy, with less stress on the patient
- Biopsy specimens even from the prostate area
- Foreign body extraction (e.g. removal of stents)
- Retrograde manipulation
- Treatment of strictures
- Powerful PANOVIEW PLUS telescope, 25° viewing direction, panoramic field of view, exceptional detail
- Specially shaped atraumatic distal tip
- Compact and sturdy construction

**Für Klinik und Praxis**

- Patientenfreundliche ambulante Urethro-Cystoskopie
- Biopsieentnahme, auch im Prostatabereich
- Fremdkörper-Extraktion (z.B. Splint-Entfernung)
- Retrograde Manipulationen
- Strikturbehandlung
- Leistungsstarke PANOVIEW PLUS-Optik, 25° Blickrichtung, Panorama-Blickfeld, ausgezeichnete Detail-Erkennbarkeit
- Atraumatisch gestaltetes, distales Ende
- Kompakte und robuste Bauweise

Cystoskop Cystoscope	NL	Charr.	Sondenkanal / Instrument channel für Hilfsinstrumente for accessory instruments		Optik 25°
	WL	Fr.	Form	Shape	Telescope 25°
<b>8642.403</b>	215 mm	14	bis / up to 5 Charr. / Fr.	oval / oval	PANOVIEW PLUS mit gesteigerter Bildgröße und Objektfeld
<b>8645.403</b>	225 mm	17	bis / up to 7 Charr. / Fr.	oval / oval	PANOVIEW PLUS telescope with enlarged image and objective field

**Accessories:**

**Fiber light cable bndI**, Ø 2.5 mm, 2.3 m long consisting of:  
Fiber light cable (80662523), adapter projector side (8095.07) and  
adapter endoscope side (809509) ..... 806625231

**Reprocess basket for atraumatic  
compact cysto-urethroscope  
complete with fittings**  
Outer dimensions (L x W x H): 450 x 80 x 62 mm ..... 38039.011

**Zubehör:**

**Fiber Lichtleiter kpl**, Ø 2,5 mm, 2,3 m lang bestehend aus:  
bestehend aus: Fiber Lichtleiter (80663523), Adapter projektorseitig  
(8095.07) und Adapter endoskopseitig (809509) ..... 806625231

**Aufbereitungskorb** für atraumatisches  
Kompakt-Cysto-Urethroskop  
komplett mit Aufnahmehalterungen  
Außen-Abmessung (L x B x H): 450 x 80 x 62 mm ..... 38039.011





Hilfsinstrumente siehe Rückseite / Accessory instruments see overleaf

## Flexible Accessory Instruments

for cystoscopes 14, 17 Fr., 25°

## Flexible Hilfsinstrumente

für Cystoskope 14, 17 Charr., 25°

		NL / WL mm	Charr. Fr.	Type Type
	Flexible Probe-Exzisionszange <i>Flexible biopsy forceps</i>	375	7	<b>829.07</b>
		315	5	<b>829.05</b>
	Flexible Greifzange <i>Flexible grasping forceps</i>	365	7	<b>828.07</b>
		315	5	<b>828.05</b>
	Flexible Schere <i>Flexible scissors</i>	375	7	<b>830.07</b>
	Koagulations-Elektrode mono <i>Coagulating electrode mono</i>	400	6	<b>823.06</b>
		400	5	<b>823.05</b>



2

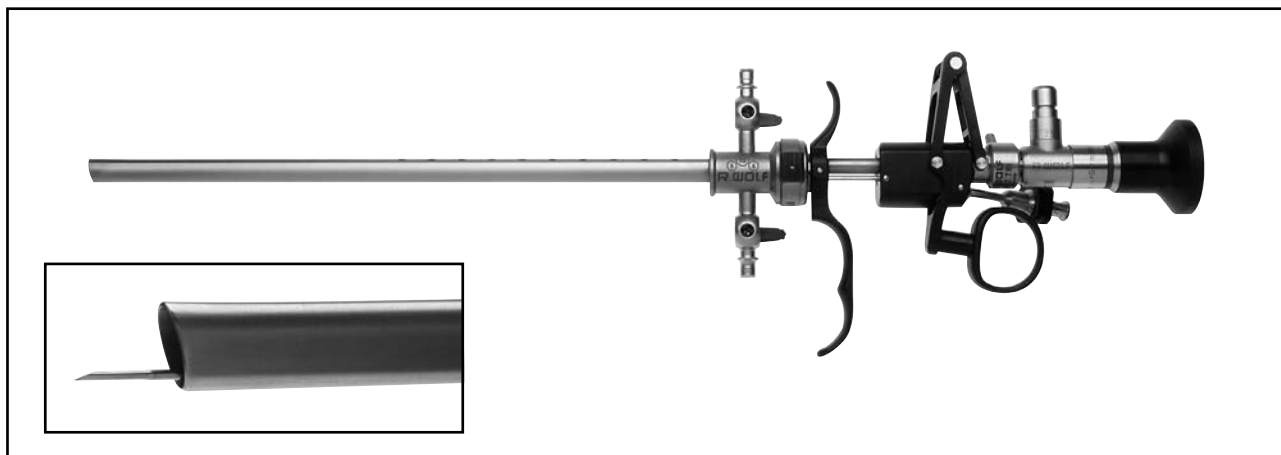

*Set for transurethral  
Incontinence Therapy*

Set zur transurethralen  
Inkontinenz-Therapie

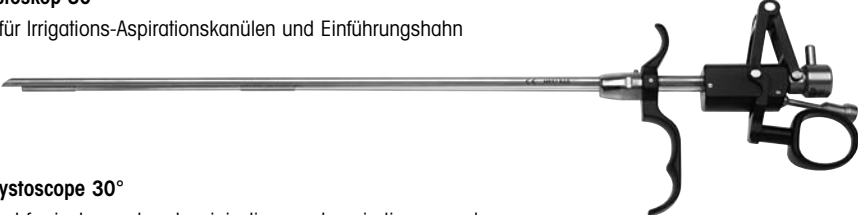

3

		Type Type
<p><b>Arbeitselement für Cystoskop 30°</b> mit drehbarem Ansatz für Irrigations-Aspirationskanülen und Einführungshahn</p>  <p><b>Working element for cystoscope 30°</b> with rotatable attachment for instrument port or injection- and aspiration cannula</p>		<b>8652.781</b>
<p><b>Einführungshahn</b> GL 31mm, Durchlass für Instrumente bis 4Charr.</p> <p><b>Instrument port</b> TL 31mm, capacity for instruments up to 4Fr.</p> 		<b>8652.788</b>
<p><b>Schaft für Cystoskop mit Obturator</b> Durchlass für Instrumente bis 10 Charr. oder 2x6 Charr.</p> <p><b>Instrument port with obturator</b> capacity for instruments up to 10 Fr. or 2x6 Fr.</p> 		<b>8652.0441</b>

Optiken Telescopes	Ø	Blickrichtung Viewing direction	mit gesteigerter Bildgröße und Objektfeld with enlarged image and objective field	
	4 mm	30°	<b>8654.422</b>	 

Accessories:

**Fiber light cable bndl**, Ø 2.5 mm, 2.3 m long  
consisting of: Fiber light cable (80662523),  
adapter projector side (8095.07) and  
adapter endoscope side (809509) ..... 806625231  
**Reprocess basket**,  
capacity 1 endoscope ..... 38021.111

Zubehör:

**Fiber Lichtleiter kpl**, Ø 2,5 mm, 2,3 m lang bestehend aus:  
bestehend aus: Fiber Lichtleiter (80663523),  
Adapter projektorseitig (8095.07) und  
Adapter endoskopseitig (809509) ..... 806625231  
**Aufbereitungskorb**,  
Aufnahmekapazität 1 Endoskop ..... 38021.111

