

Aesculap Surgical Instruments

ENT Catalog
HNO Katalog



Aesculap Surgical Technologies

Think Surgical Instruments. Think Aesculap.

Surgical Instruments. Process Optimization. Support.

Preface
Vorspann



Think Partnership.
Think Aesculap.



Think Competence.
Think Aesculap.



Think Service.
Think Aesculap.



Think Quality.
Think Aesculap.

Knowledge shared is knowledge multiplied!

"Sharing Expertise" has been the B. Braun philosophy for more than 170 years. Sharing expertise across all divisions of the company helps to create a broader and deeper knowledge base for everyone involved and results in far-sighted, detailed solutions and maximum safety for the benefit of both, the patient and healthcare professionals.

With more than 145 years of surgical instrument experience, Aesculap is a competent partner

for interdisciplinary knowledge transfer. The Aesculap brand represents a varied spectrum that intelligently and economically combines high-quality products with process-oriented services. Aesculap is a reliable and accepted partner for the entire surgical process in the hospital.

Aesculap owes its standing among the best in the business to its employees, who are never satisfied with the first idea that comes along

and keep testing, scrutinizing and refining each and every development until they find the best possible solution.

Thus, Aesculap is much more than a supplier of high precision surgical instruments: a partner who listens carefully and contributes ideas, who understands the customer's needs and requirements and provides for them on a high level. From products to services and seminars for all areas of activity within the hospital.

Think Surgical Instruments. Think Aesculap. Surgical Instruments. Process Optimization. Support.



Think Economy.
Think Aesculap.



Think Innovation.
Think Aesculap.

Wissen mehrt sich, wenn man es teilt!

Profundes Wissen setzt voraus, Kenntnisse und Erfahrungen zu vernetzen sowie diese folgerichtig zu bewerten.

Diesem Prinzip folgt B. Braun konsequent seit mehr als 170 Jahren, in der Aussage „Sharing Expertise“ spiegelt es sich ausdrücklich wider. Der Wissensaustausch über alle Sparten des Konzerns hinweg schafft eine breitere und somit fundiertere Wissensbasis für alle Beteiligten – insbesondere auch für Aesculap. Das Ergebnis sind bis ins Detail durchdachte, weitsichtige Lösungen und ein Höchstmaß an Sicherheit. Sie dienen dem Wohl des Patienten und dem Interesse der Anwender.

Mit mehr als 145 Jahren Erfahrung im Segment der chirurgischen Instrumente ist Aesculap ein kompetenter Partner für den interdisziplinären Wissensaustausch. Die Produktmarke Aesculap steht für ein vielfältiges Leistungsspektrum, das hochwertige Produkte mit prozessorientierten

Dienstleistungen intelligent und im Sinne der Wirtschaftlichkeit verknüpft.

Aesculap ist ein verlässlicher und akzeptierter Partner für den gesamten chirurgischen Prozessablauf in der Klinik.

Dass Aesculap zu den Besten der Branche gehört, verdankt das Unternehmen seinen Mitarbeiterinnen und Mitarbeitern. Sie geben sich nicht mit der ersten Idee zufrieden, sondern prüfen, hinterfragen und verbessern jede einzelne Entwicklung immer wieder auf der Suche nach der bestmöglichen Lösung.

Deshalb ist Aesculap weit mehr als ein Lieferant hochpräziser chirurgischer Instrumente: Aesculap ist ein Partner, der genau zuhört und mitdenkt, die Bedürfnisse und Anforderungen seiner Kunden versteht und sie auf hohem Niveau versorgt. Vom Produkt über die Dienstleistungen bis zu den Seminaren für alle Funktionsbereiche.

**Otology,
Micro Ear Surgery**

Otologie, Mikro Ohrchirurgie

1 - 48

**FESS, Rhinology,
Rhinoplasty**FESS, Rhinologie, Septum- und
Nasenplastik

49 - 114

**Adenoidectomy,
Tonsillectomy**

Adenotomie, Tonsillektomie

115 - 148

Laryngology

Laryngologie

149 - 162

**Micro Vascular
Surgery**

Mikro Gefäßchirurgie

163 - 198

**Bone
Instruments**

Knocheninstrumente

199 - 272

273 - 338

Retraktoren, Wundhaken



**Retractors,
Hooks**

Content
Inhalt

339 - 356

————— Patient Preparation

357 - 372

————— Scalpels

373 - 426

————— Scissors

427 - 456

————— Forceps

457 - 498

————— Clamps

499 - 516

———— Needle Holder, Ligature Instruments

517 - 526

———— Probes, Cotton Carriers, Redon Spike

527 - 546

———— Suction Instruments, Syringes

Surgical Instruments



**Surgical
Instruments**

Chirurgische Instrumente

339 - 356

————— Patienten-Vorbereitung

357 - 372

————— Skalpelle

373 - 426

————— Scheren

427 - 456

————— Pinzetten

457 - 498

————— Klemmen

499 - 516

———— Nadelhalter, Ligatur-Instrumente

517 - 526

———— Sonden, Watteträger, Redon Spieße

527 - 546

———— Sauginstrumente, Spritzen

547 - 556

Aufbereitung



Reprocessing

557 - 575

Alphabetical Index

576 - 594

Alphabetischer Index

595 - 612

Numerical Index

Nummernverzeichnis

Index

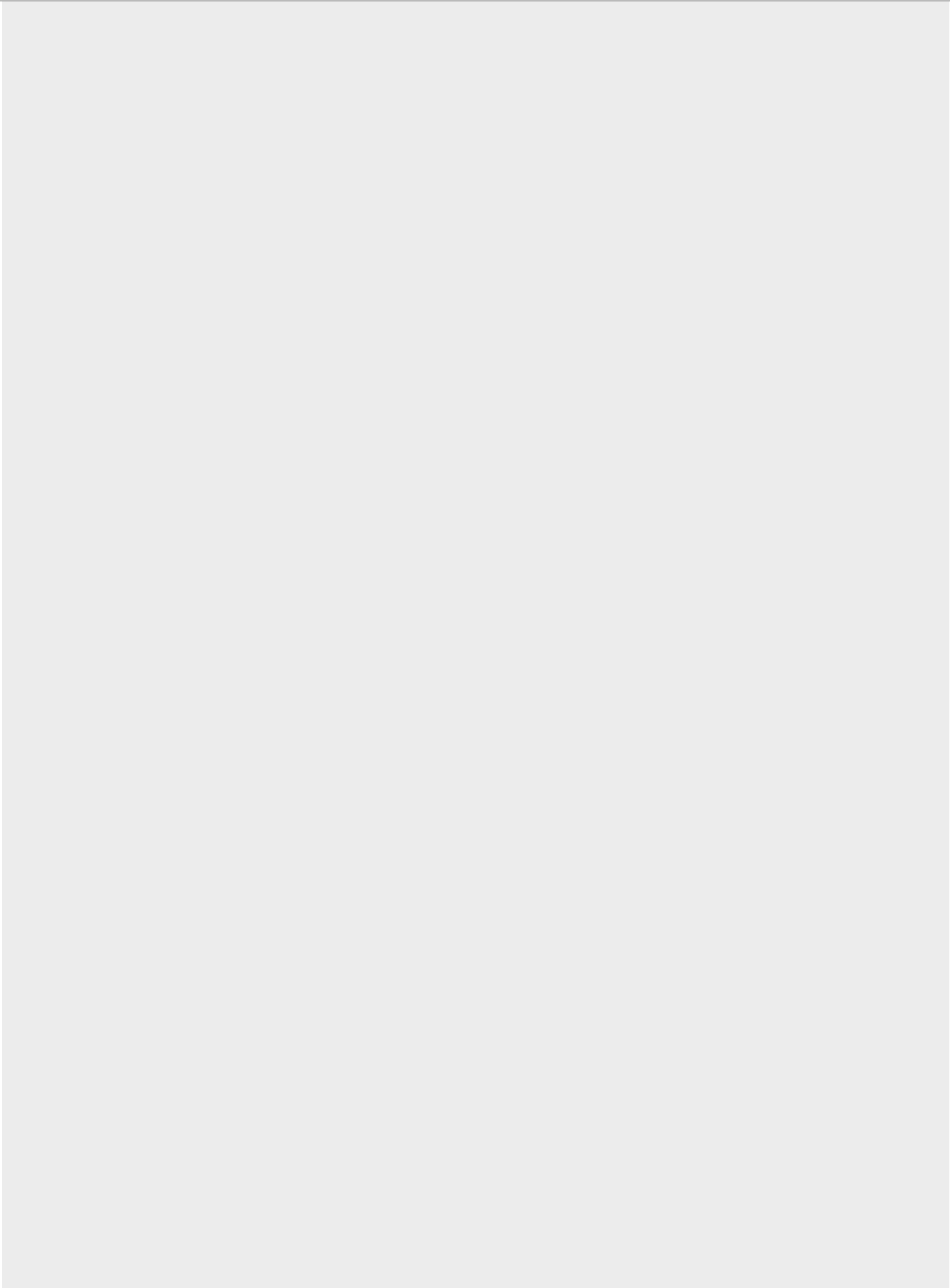

Otology, Micro Ear Surgery
Otologie, Mikro-Ohrchirurgie



Otology, Micro Ear Surgery – Otologie, Mikro-Ohrchirurgie

Ear Specula

Ohrspekula

Otology
Otologie



POLITZER

Art. No. Art. Nr.	Diam. Ø	Sales unit Bestelleinheit
OF101C		Set of 3 sizes Satz à 3 Stück
OF102C	2.0 mm ○	
OF103C	3.0 mm ○	
OF104C	4.0 mm ○	

for children, inside nonreflective,
outside mirror finish chromium plated
für Kinder, innen matt,
außen hochglanz-verchromt

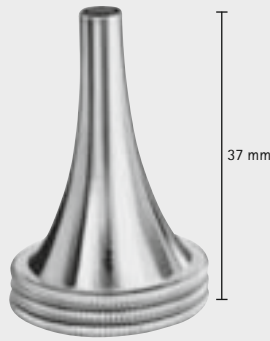

HARTMANN

Art. No. Art. Nr.	Diam. Ø	
OF115C	1.8 mm ○	
OF116C	3.2 mm ○	
OF117C	4.6 mm ○	

for children, inside nonreflective,
outside mirror finish chromium plated
für Kinder, innen matt,
außen hochglanz-verchromt

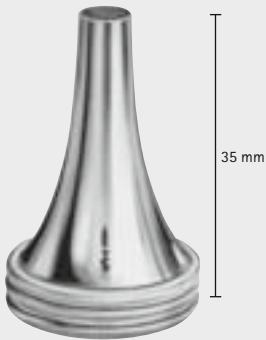

HARTMANN

Art. No. Art. Nr.	Diam. Ø	Sales unit Bestelleinheit
OF108C		Set of 3 sizes / Satz à 3 Stück (OF111C, OF112C, OF113C)
OF111C	3.5 mm ○	
OF112C	5.0 mm ○	
OF113C	6.5 mm ○	
OF114C	8.0 mm ○	

for adults, inside nonreflective,
outside mirror finish chromium plated
für Erwachsene, innen matt,
außen hochglanz-verchromt



BOUCHERON

Art. No. Art. Nr.	Diam. Ø	Sales unit Bestelleinheit
OF120C		Set of 4 sizes Satz à 4 Stück
OF121C	4 mm ○	
OF122C	5 mm ○	
OF123C	6 mm ○	
OF124C	7 mm ○	

for adults, inside nonreflective,
outside mirror finish chromium plated
für Erwachsene, innen matt,
außen hochglanz-verchromt

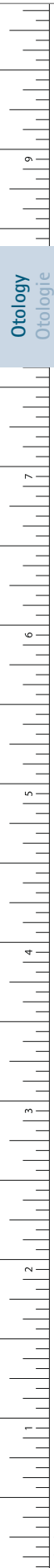

Otology, Micro Ear Surgery – Otologie, Mikro-Ohrchirurgie

Ear Specula

Ohrspekula

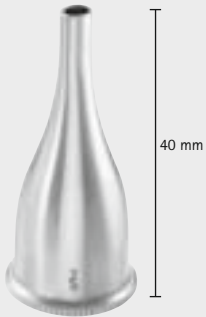

GRUBER

Art. No. Art. Nr.	Diam. Ø	
OF161	2.8 x 3.5 mm	○
OF162	4.0 x 4.6 mm	○
OF163	5.2 x 6.2 mm	○
OF164	6.4 x 7.8 mm	○

oval lumen
oval



HARTMANN

Art. No. Art. Nr.	Diam. Ø	
OF313R	3.0 mm	○
OF314R	4.0 mm	○
OF315R	5.0 mm	○
OF316R	6.0 mm	○
OF317R	7.5 mm	○

round lumen, stainless steel
rund, Edelstahl



TOYNBEE

Art. No. Art. Nr.	Diam. Ø	Sales unit Bestelleinheit
OF125C		Set of 3 sizes Satz à 3 Stück
OF126C	4.0 mm	○
OF127C	5.5 mm	○
OF128C	7.0 mm	○

for adults, inside non-reflective,
outside mirror finish chromium plated
für Erwachsene, innen matt,
außen hochglanzverchromt



HARTMANN

Art. No. Art. Nr.	Diam. Ø	
OF158	8.0 mm	○
OF159	9.0 mm	○

for post-treatment, for adults,
aluminium, black anodized
zur Nachbehandlung, für Erwachsene,
Aluminium, schwarz eloxiert

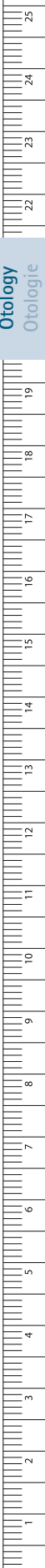

MILLIMETERS

Otology, Micro Ear Surgery – Otologie, Mikro-Ohrchirurgie

Ear Specula

Ohrspekula

Otology
Otologie



HARTMANN

Art. No. Art. Nr.	Diam. Ø	
OF136	3.0 mm	○
OF137	4.0 mm	○
OF138	5.0 mm	○
OF139	7.0 mm	○

Ear specula for adults, aluminium, black anodized
für Erwachsene, Aluminium, schwarz eloxiert

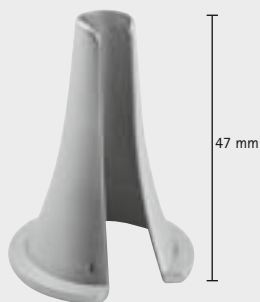

TUMARKIN

Art. No. Art. Nr.	Diam. Ø	Sales unit Bestelleinheit
OF290		Set of 8 sizes Satz à 8 Stück
OF291	3.2 mm	○
OF292	5.0 mm	○
OF293	5.5 mm	○
OF294	6.2 mm	○
OF295	6.6 mm	○
OF296	7.0 mm	○
OF297	7.6 mm	○
OF298	9.6 mm	○

tapered slot
geschlitzt



ROSEN

Art. No. Art. Nr.	Diam. Ø	
OF093	3.0 mm	○
OF094	4.0 mm	○
OF095	5.0 mm	○
OF096	6.0 mm	○
OF097	7.0 mm	○

round lumen
rund

Otology, Micro Ear Surgery – Otologie, Mikro-Ohrchirurgie

Ear Specula

Ohrspekula



ROSEN

Art. No. Art. Nr.	Diam. Ø	
OF043	3.3 x 4.1 mm	
OF044	4.0 x 5.5 mm	
OF045	5.0 x 7.5 mm	
OF046	6.0 x 8.5 mm	
OF047	7.0 x 9.5 mm	

oval lumen
oval

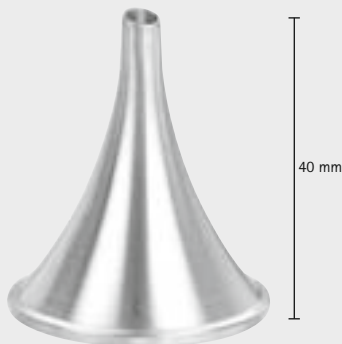

SHEA

Art. No. Art. Nr.	Diam. Ø	Sales unit Bestelleinheit
OF150		Set of 5 sizes Satz à 5 Stück
OF151	3.5 x 4.0 mm	
OF152	3.9 x 5.5 mm	
OF153	5.0 x 7.4 mm	
OF154	5.8 x 8.3 mm	
OF155	7.3 x 9.7 mm	

oblique ended
abgeschrägt



ZÖLLNER

Art. No. Art. Nr.	Diam. Ø	
OF171	5.5 x 6.5 mm	
OF172	6.5 x 7.5 mm	
OF173	7.5 x 8.5 mm	
OF174	8.5 x 9.5 mm	
OF175	9.5 x 10.5 mm	
OF176	10.5 x 11.5 mm	

for adults, oval, made of aluminium,
in and outside black anodised to eliminate reflection
für Erwachsene, oval, aus Aluminium, schwarz eloxiert

Otology, Micro Ear Surgery – Otologie, Mikro-Ohrchirurgie

Flexible Arm, Ear Specula Holder, Nystagmus Spectacles

Spannarm, Ohrspekulahalter, Nystagmusbrille

Otology
Otologie

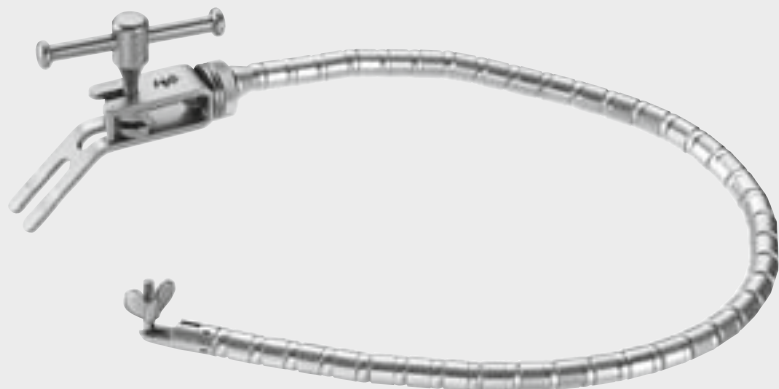

YASARGIL

FF270R

Flexible arm only, mobile in all directions
Spannarm allein, umsteckbar und nach allen
Richtungen beweglich



FF266R

Clamp for fixing flexible arm FF270R to the bow
or the rail of the operating table
Fixiervorrichtung zum Befestigen des Spannarmes FF270R
am Bügel oder der Stange des OP-Tisches



FF275R

Ear specula holder only, for specula:
OF111C-OF114C, OF115C-OF117C, OF126C-OF128C,
OF136-OF139, OF158-OF159
Ohrspekulahalter allein, passend für die Spekula:
OF111C-OF114C, OF115C-OF117C, OF126C-OF128C,
OF136-OF139, OF158-OF159



OF080

Nystagmus spectacles for observation of the eyes during
examination of the vestibular apparatus, with battery handle
and fixed glasses. Illuminated on inside of lenses.
Source of energy: 2 baby-battery cells, 1.5 volts,
2 bulbs, 4 volt, OF081
Beleuchtete Nystagmusbrille mit querliegendem
Batteriehandgriff und festen Gläsern
Energiequelle: 2 Stück Baby-Zellen 1,5 Volt,
2 Stück 4-Volt-Lämpchen OF081



OF081

Spare bulb, 4 volt
for Nystagmus spectacles OF080
Ersatz-Birnchen 4 Volt
für Nystagmusbrillen OF080

Otology, Micro Ear Surgery – Otologie, Mikro-Ohrchirurgie

Tuning Forks

Stimmgabeln



1/2

HARTMANN

Art. No. Art. Nr.	Frequency Frequenz
OF001N	c ¹ 128
OF002N	c ¹ 256
OF003N	c ² 512
OF004N	c ³ 1024
OF005N	c ⁴ 2048
OF006N	c ⁵ 4096



1/2

Art. No. Art. Nr.	Frequency Frequenz
OF010N	a ¹ 440



1/2

LUCAE

Art. No. Art. Nr.	Frequency Frequenz
OF015N	c ¹ 128
OF016N	c ¹ 256
OF017N	c ² 512
OF018N	c ³ 1024
OF019N	c ⁴ 2048



1/2

LUCAE

Art. No. Art. Nr.	Frequency Frequenz
OF031N	c ¹ 128

for neurologists
für den Neurologen

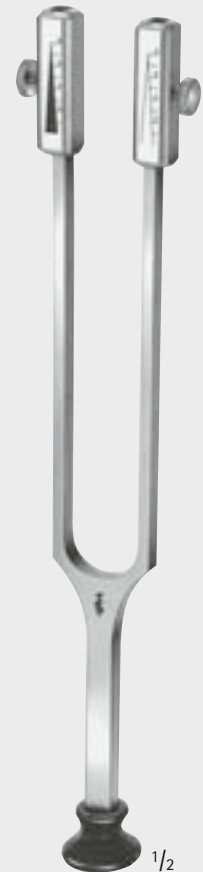

1/2

RYDEL-SEIFFERT

Art. No. Art. Nr.	Frequency Frequenz
OF033N	with clamp mit Dämpfer c ¹ 64 without clamp ohne Dämpfer c ¹ 128

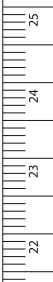
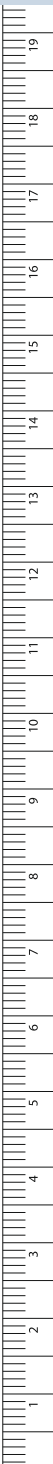
Otology
Otologie

MILLIMETERS

Otology, Micro Ear Surgery – Otologie, Mikro-Ohrchirurgie

Eustachian Catheters, Ear Probes, Cerumen Scoop

Tubenkatheter, Ohrsonden, Zerumenlöffel

Otology
Otologie



OF190

Air douche, with metal mount
Luftdusche mit Metallmontur



Art. No. Art. Nr.	Diam. (mm) Ø (mm)
OF195N	18
OF196N	21
OF197N	23

Metal nasal tips
Nasenoliven aus Metall



OF191N

Metal connector (Eustachian catheter to POLITZER air douche) to connect Eustachian catheter to POLITZER bulb
Tubenkatheter-Aufsatz zur POLITZER Luftdusche OF190



HARTMANN

Art. No. Art. Nr.	Diam. (mm) Ø (mm)
OF250C	2.0
OF251C	2.5
OF252C	3.0
OF253C	4.0
OF254C	5.0

Eustachian catheter
Tubenkatheter



JOBSON HORNE

Art. No. Art. Nr.	Length Länge
OF266R	140 mm, 5 1/2"
OF267R	180 mm, 7"

Ear probes
Ohrsonden



FORMBY

OF360R

Cerumen scoop and hook
Zerumenlöffel und-Häkchen
180 mm, 7"

- Please find further probes and cotton carriers in chapter probes, starting on page 517
- Für weitere Sonden und Watteträger, siehe Kapitel Sonden, ab Seite 517

INCHES

Otology, Micro Ear Surgery – Otologie, Mikro-Ohrchirurgie

Sickle Knives, Tympanum Perforators, Myringotomes

Sichelmesser, Paracentesenadel, Myringotome



1/1
1/2

POLTZER
OF600R
Sickle knife
Sichelmesser
160 mm, 6 1/4"



OF614R
for children
für Kinder
160 mm
6 1/4"

OF615R
for adults
für Erwachsene
190 mm
7 1/2"

OF618R
for children,
handle 90° angled
to the lancet
für Kinder
Grifffläche 90°
zur Lanzette
180 mm
7"

LUCAE
OF614R-OF618R
Tympanum perforator, bayonet-shaped
Paracentesenadel, bajonettförmig



1/1
1/2

POLTZER
OF608R
Tympanum perforator, angled
Paracentesenadel, kniegebogen
160 mm, 6 1/4"



1/1
1/2

AGNEW (POLTZER)
OF610R
Myringotome, angled
Myringotom, kniegebogen
175 mm, 6 7/8"



1/1
1/2

adjustable blade,
reversing into handle
verstellbare Klinge,
im Handgriff versenkbar

OF626R
Universal-Myringotome
Universal-Myringotom
170 mm, 6 3/4"

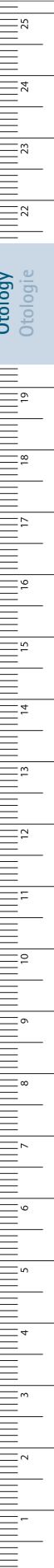

Otology, Micro Ear Surgery – Otologie, Mikro-Ohrchirurgie

Ear Loops, Ear Elevator, Cerumen Pick and Wool Carrier

Ohrschlingen, Ohrheber, Zerumennadel und Watteträger



Otology
Otologie

3 mm 4 mm

OF271R OF272R

BILLEAU
OF271R-OF272R
Ear loop, straight
Ohrschlinge, gerade
160 mm, 6 1/4"

WEBER

Art. No. Art. Nr.	Size Größe	Width Breite	Length Länge
OF270R	0	3 mm	145 mm, 5 3/4"
OF289R	1	4 mm	145 mm, 5 3/4"

Ear loop, curved and serrated
Ohrschlinge, gebogen und gerieft

3 mm

OF320R

LANGENBECK
OF320R
Ear loop, curved, serrated
Ohrschlinge, gebogen und gerieft
130 mm, 5 1/8"

ZAUFAL
OF274R
Ear elevator, blunt
Ohrheber, stumpf
150 mm, 6"

MUSGROVE
OF361R
Cerumen pick and wool carrier
Zerumennadel und Watteträger
180 mm, 7"

Otology, Micro Ear Surgery – Otologie, Mikro-Ohrchirurgie

Ear Curettes

Ohrküretten

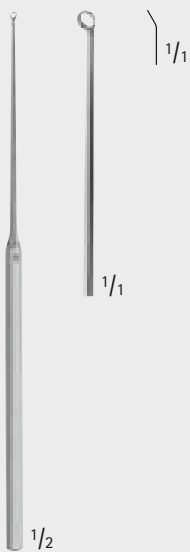

BUCK

Art. No. Art. Nr.	Figure Figur	Outside diam. Außen-Ø (mm)	
OF350R	00	1.5	○
OF351R	0	2.0	○
OF352R	1	2.5	○
OF353R	2	3.0	○
OF354R	3	4.0	○

curved, sharp
gebogen, scharf
150 mm, 6"

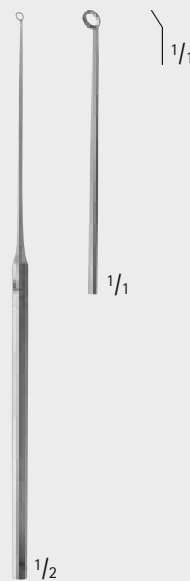

BUCK

Art. No. Art. Nr.	Figure Figur	Outside diam. Außen-Ø (mm)	
OF355R	00	1.5	○
OF356R	0	2.0	○
OF357R	1	2.5	○
OF358R	2	3.0	○
OF359R	3	4.0	○

curved, blunt
gebogen, stumpf
150 mm, 6"

Otology
Otologie

MILLIMETERS

Otology, Micro Ear Surgery – Otologie, Mikro-Ohrchirurgie

Ear Hooks, Cerumen Hook

Ohrhäkchen, Ohrhebel, Zerumenhäkchen



Otology
Otologie

OF282R **OF283R** **OF284R** **OF285R**

WAGENER
OF282R-OF285R
Ear hooks
Ohrhäkchen
150 mm, 6"

ST. BARTS
OF288R
Ear hook, blunt
Ohrhäkchen, stumpf
180 mm, 7"

OF277R **OF278R** **OF279R**

LUCAE
OF277R-OF279R
Ear hooks, probe ended
Ohrhebel, geknöpft
140 mm, 5 1/2"

Diam. of tip: 1.7 mm
Knopf-Ø: 1,7 mm

CAWTHORNE
OF276R
Cerumen hook
Zerumenhäkchen
140 mm, 5 1/2"

Otology, Micro Ear Surgery – Otologie, Mikro-Ohrchirurgie

Ear Snare, Ear Snare Wire, Ear Forceps

Ohrpolypenschnürer, Ohrpolypenschlingen, Fremdkörperinstrumente

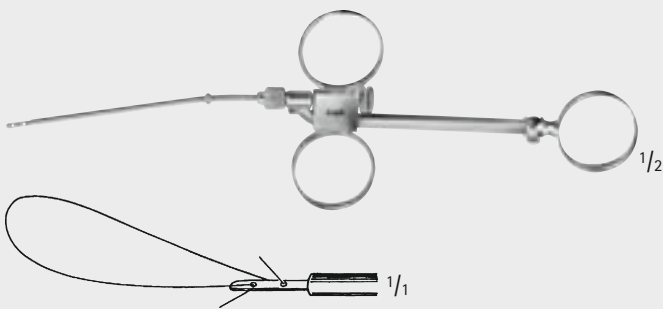

KRAUSE

OF505R

Ear snare

Ohrpolypenschnürer

160 mm, 6 1/4"

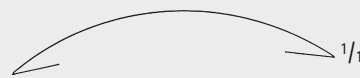

OF528R

Ear snare wire

Sales unit: PAK = Package of 100 pieces

Ohrpolypen-Schlingen

Bestelleinheit: PAK = Packung à 100 Stück

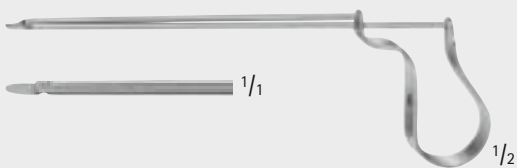

QUIRE

OF300R

Ear forceps

for removal of foreign bodies

Fremdkörperinstrument

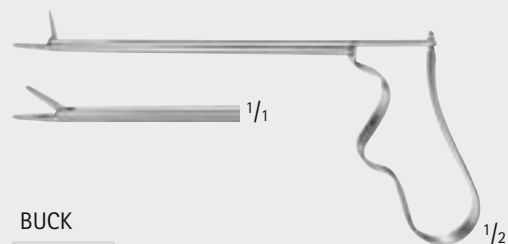

BUCK

OF303R

Ear forceps, alligator type, serrated jaws,

for removal of foreign bodies

Fremdkörperinstrument

Otology
Otologie

MILLIMETERS

Otology, Micro Ear Surgery – Otologie, Mikro-Ohrchirurgie

Micro Scissors with Tubular Shaft

Rohrschaft-Mikro-Scherchen

Otology
Otologie

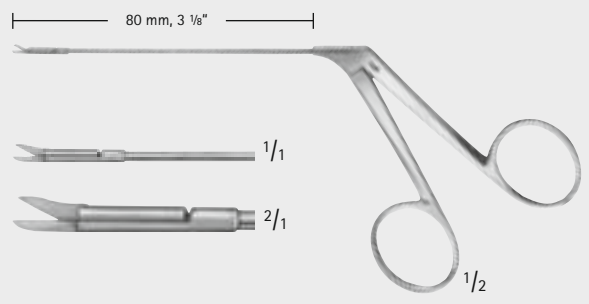

OG350R

straight, sharp/sharp
gerade, spitz/spitz



BELLUCCI
OG350R-OG355R

OG351R

upwards curved, blunt/blunt
nach oben gebogen, stumpf/stumpf

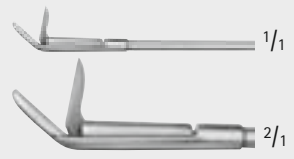

OG352R

left curved, sharp/sharp
nach links gebogen, spitz/spitz



OG353R

right curved, sharp/sharp
nach rechts gebogen, spitz/spitz



OG355R

horizontal cutting
horizontal schneidend



Otology, Micro Ear Surgery – Otologie, Mikro-Ohrchirurgie

Micro Scissors, Micro Crurotomy Scissors

Mikro-Scherchen, Mikro-Crurotomiescherchen

OG354R 4.0 x 1.5 mm
 straight, sharp/sharp
 gerade, spitz/spitz

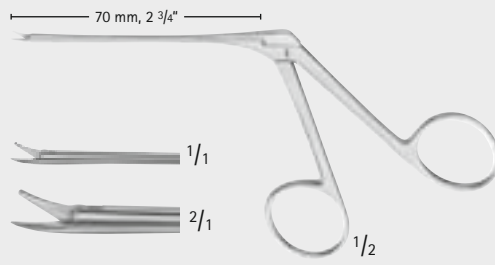

CAWTHORNE

OG354R

Micro scissors

Mikro-Ohrscherchen

OG356R
 left curved
 links gebogen

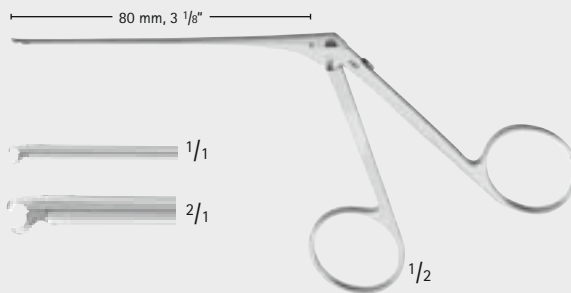

OG356R-OG357R

Micro crurotomy scissors

Mikro-Crurotomiescherchen

OG357R
 right curved
 rechts gebogen



Otology
 Otologie

MILLIMETERS

Otology, Micro Ear Surgery - Otologie, Mikro-Ohrchirurgie

Alligator Forceps

Mikro-Fasszängchen



Otology
Otologie

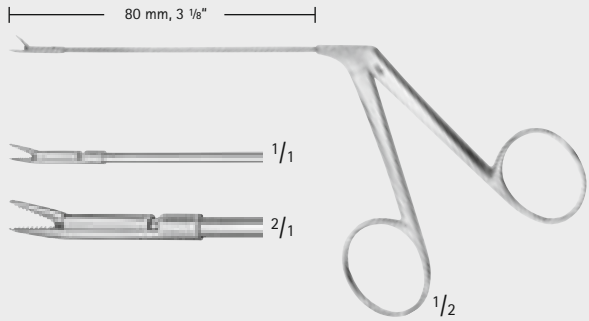

OG330R 0.8 x 3.5 mm
straight
gerade

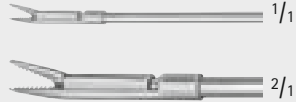

OG325R-OG330R

OG335R 1.0 x 5.0 mm
straight
gerade



OG325R 1.5 x 6.5 mm
straight
gerade



Otology, Micro Ear Surgery – Otologie, Mikro-Ohrchirurgie

Alligator Forceps Mikro-Fasszängchen

OG331R 0.8 x 3.5 mm
65° upwards curved
65° nach oben gebogen

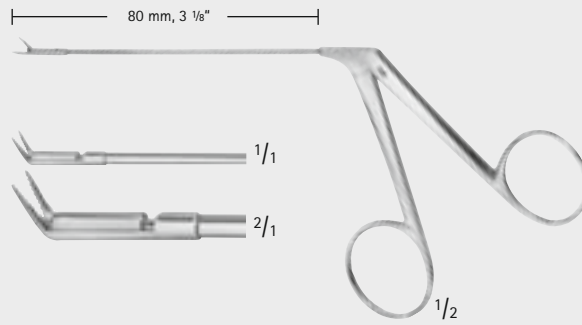

OG331R-OG339R

OG332R 0.8 x 3.5 mm
45° downwards curved
45° nach unten gebogen

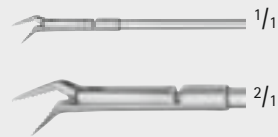

OG338R 1.0 x 5.0 mm
left curved
links gebogen

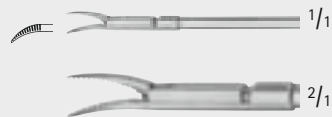

OG339R 1.0 x 5.0 mm
right curved
rechts gebogen



Otology
Otologie

MILLIMETERS

Otology, Micro Ear Surgery – Otologie, Mikro-Ohrchirurgie

Micro Ear Forceps, Ear Forceps

Mikro-Fasszängchen, Fasszängchen

Otology
Otologie



HOUGH

OG329R 1.0 x 5.0 mm
straight
gerade

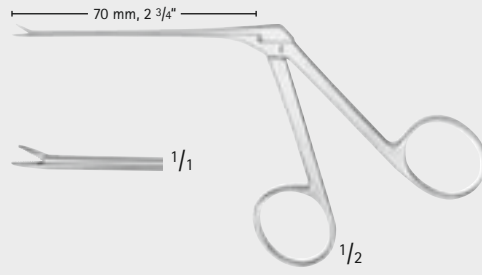

OG329R-OG334R

Micro ear forceps
Mikro-Fasszängchen

CAWTHORNE

OG334R 1.25 x 5.0 mm
straight, smooth jaw
gerade, glattes Maul



HARTMANN-WULLSTEIN

OF410R 0.5 x 6.0 mm
straight
gerade

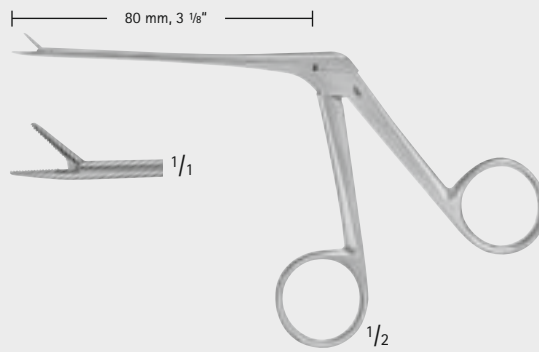

OF410R-OF420R

Ear forceps
Fasszängchen

HARTMANN

OF411R 1.0 x 8.0 mm
straight
gerade



HARTMANN-WULLSTEIN

OF414R 1 x 8 mm
straight
gerade



HARTMANN

OF420R 1 x 8 mm
straight, 1 x 2 teeth
gerade, 1 x 2 Zähne



Otology, Micro Ear Surgery – Otologie, Mikro-Ohrchirurgie

Micro Cup Forceps Mikro-Löffelzängchen

OG341R 0.9 x 1.0 mm
straight, oval jaw
gerade, Maul oval

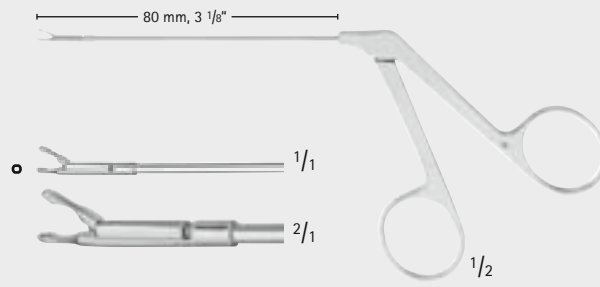

OG341R-OG348R

WULLSTEIN

OG345R 0.8 x 1.3 mm
straight, oval jaw
gerade, Maul oval

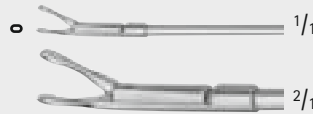

WULLSTEIN

OG346R Diam. / Ø 1.0 mm
straight, round jaw
gerade, Maul rund

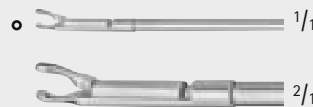

WULLSTEIN

OG348R 1.7 x 2.5 mm
straight, oval jaw
gerade, Maul oval



Otology
Otologie

MILLIMETERS

Otology, Micro Ear Surgery – Otologie, Mikro-Ohrchirurgie

Micro Cup Forceps

Mikro-Löffelzängchen



Otology
Otologie

OG342R 0.9 x 1.0 mm
upwards curved, oval jaw
nach oben gebogen, Maul oval

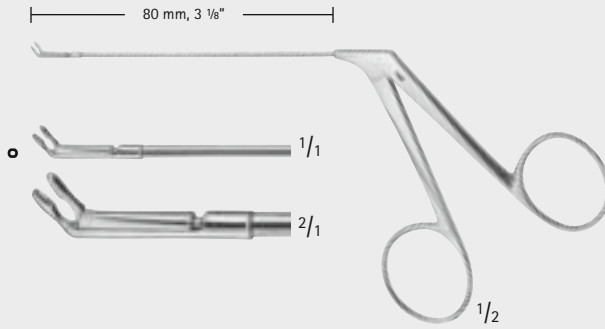

OG342R-OG344R

WULLSTEIN

OG343R 0.8 x 1.3 mm
left curved, oval jaw
links gebogen, Maul oval

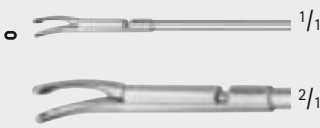

WULLSTEIN

OG344R 0.8 x 1.3 mm
right curved, oval jaw
rechts gebogen, Maul oval

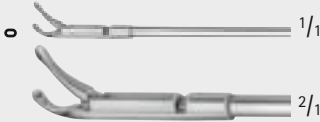

Otology, Micro Ear Surgery – Otologie, Mikro-Ohrchirurgie

Cup Forceps Löffelzängchen

HARTMANN-WULLSTEIN

OF442R Diam. / Ø 1 mm
delicate, straight, round jaw
fein, gerade, Maul rund

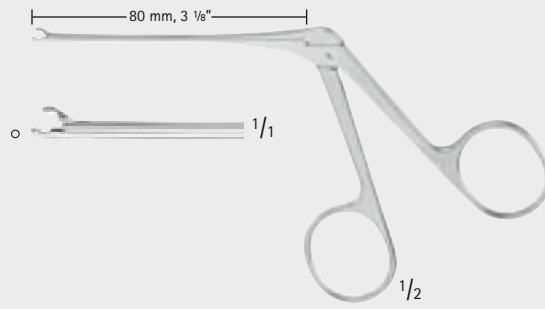

OF438R-OF442R

HARTMANN-WULLSTEIN

OF444R Diam. / Ø 2 mm
delicate, straight, round jaw
fein, gerade, Maul rund



HARTMANN

OF438R Diam. / Ø 2 mm
straight, round jaw
gerade, Maul rund



HARTMANN

OF439R Diam. / Ø 2.5 mm
straight, round jaw
gerade, Maul rund



HARTMANN

OF440R Diam. / Ø 3 mm
straight, round jaw
gerade, Maul rund



Otology
Otologie

MILLIMETERS

Otology, Micro Ear Surgery – Otologie, Mikro-Ohrchirurgie

Cup Forceps

Löffelzängchen

Otology
Otologie



HARTMANN-CITELLI

OF448R Diam. / Ø 2 mm
upwards curved, round jaw
aufgebogen, Maul rund

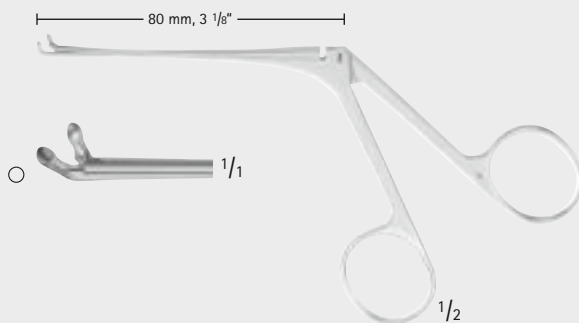

OF425R-OF448R

HARTMANN

OF425R 2 x 7 mm
straight, round jaw
gerade, Maul rund



ORMEROD

OF423R 4.0 x 1.7 mm
straight, oval jaw
gerade, Maul oval

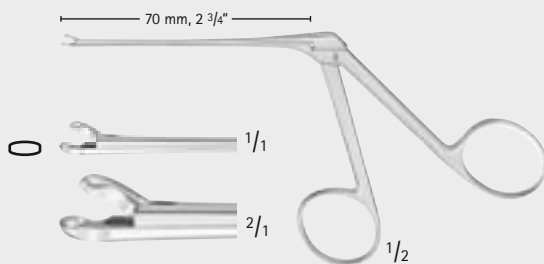

ORMEROD
OF423R

OF424R

5 x 1 mm
straight, round jaw
gerade, Maul rund

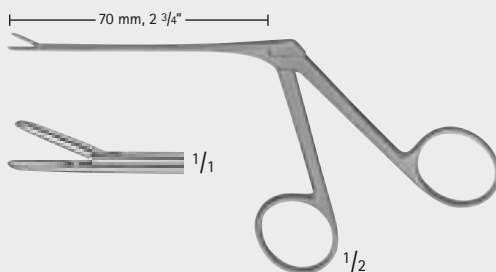

ORMEROD
OF424R

Otology, Micro Ear Surgery – Otologie, Mikro-Ohrchirurgie

Malleus Nipper, Micro Wire Bending Forceps

Mikro-Stanzen, Mikro-Drahtbiegezügchen

DIETER

OG300R

Malleus nipper,
upwards cutting

Mikro-Stanze,
nach oben schneidend

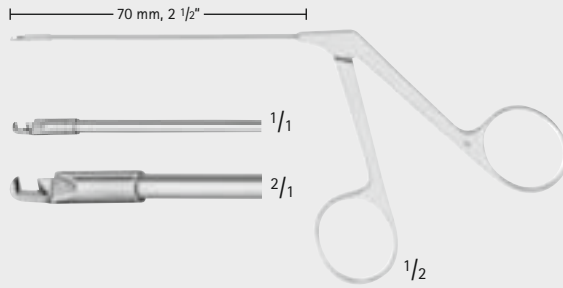

OG300R-OG360R

DIETER

OG301R

Malleus nipper,
downwards cutting

Mikro-Stanze,
nach unten schneidend



MC GEE

OG359R

Wire bending forceps,
curved down

jaw length: 3.5 mm
Mikro-Drahtbiegezügchen,
nach unten gebogen,
Maullänge: 3,5 mm

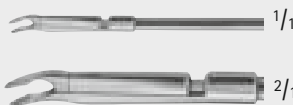

MC GEE

OG360R

Wire bending forceps,
curved down

jaw length: 5 mm
Mikro-Drahtbiegezügchen,
nach unten gebogen,
Maullänge: 5 mm

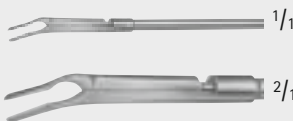

Otology
Otologie

MILLIMETERS

Otology, Micro Ear Surgery – Otologie, Mikro-Ohrchirurgie

Ear Forceps, Ear Tampon Forceps

Löffelzängchen, Ohrtamponzangen

Otology
Otologie

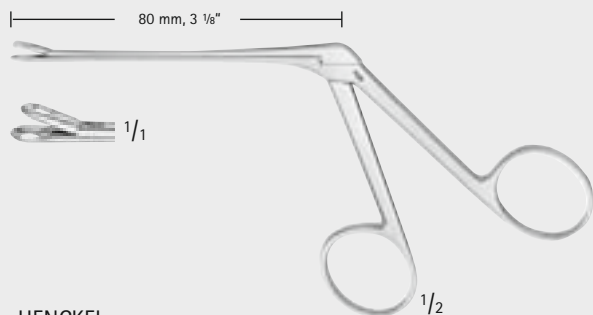

HENCKEL

OF431R 3 x 5 mm

Ear forceps, flat oval spoon, fenestrated
Löffelzängchen, oval, gefenstert

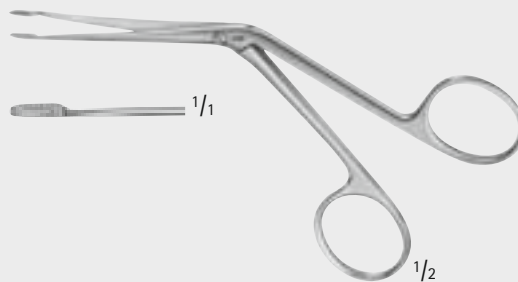

HARTMANN

OF403R

Ear tampon forceps, delicate pattern
Ohrtamponzange, feines Modell
135 mm, 5 1/4"



HARTMANN

OF405R

Ear tampon forceps, strong pattern
Ohrtamponzange, kräftiges Modell
135 mm, 5 1/4"

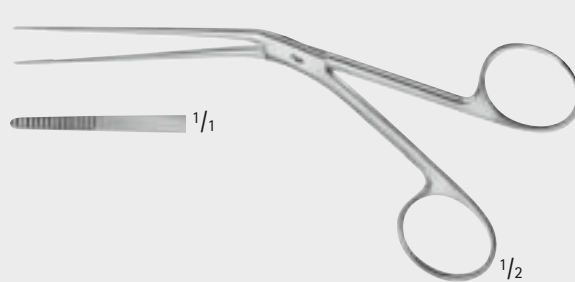

TILLEY

OF407R

Ear tampon forceps, extra fine pattern
Ohrtamponzange, extra feines Modell
140 mm, 5 1/2"

- For bone instruments see chapter bone instruments, starting on page 199
- For hooks see chapter retractors and hooks, starting on page 273
- For general instruments see chapter instruments, on page 339
- Knocheninstrumente siehe Kapitel Knocheninstrumente, ab Seite 199
- Häkchen siehe Kapitel Retraktoren und Wundhaken, ab Seite 273
- Allgemeines Instrumentarium siehe Kapitel Instrumente, ab Seite 339

Otology, Micro Ear Surgery – Otologie, Mikro-Ohrchirurgie

Micro Needles

Mikro-Nadeln

Otology
Otologie

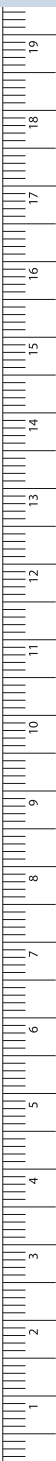

OG001R-OG006R

160 mm, 6 1/4"

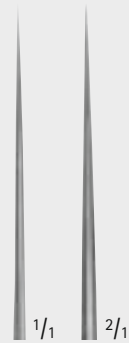

WULLSTEIN

OG001R

straight, sharp/sharp
gerade, spitz/spitz



WULLSTEIN

OG006R

slightly curved, sharp
leicht gebogen, spitz



OG002R

curved, sharp
gebogen, spitz



OG003R

strong curved, sharp, delicate
stark gebogen, spitz, fein



ROSEN

OG005R

curved, sharp
gebogen, spitz

Otology, Micro Ear Surgery – Otologie, Mikro-Ohrchirurgie

Micro Perforators

Mikro-Perforatoren

Otology
Otologie



OG070R-OG075R

160 mm, 6 1/4"



OG070R
Diam. 0.3 mm
Ø 0,3 mm



OG071R
Diam. 0.4 mm
Ø 0,4 mm



OG072R
Diam. 0.5 mm
Ø 0,5 mm



OG073R
Diam. 0.6 mm
Ø 0,6 mm



OG074R
Diam. 0.7 mm
Ø 0,7 mm



OG075R
Diam. 0.8 mm
Ø 0,8 mm

Otology, Micro Ear Surgery – Otologie, Mikro-Ohrchirurgie

Micro Hooks Mikro-Häkchen

Otology
Otologie

MILLIMETERS



1/1

SHAMBAUGH

OG007R-OG086R

45° angled

45° abgewinkelt

160 mm, 6 1/4"



1/1 2/1

OG007R

0.4 mm



1/1 2/1

OG008R

0.6 mm



1/1 2/1

OG009R

0.8 mm



1/1 2/1

OG010R

1.0 mm



1/1 2/1

OG084R

1.5 mm



1/1 2/1

OG085R

2.0 mm



1/1 2/1

OG086R

2.5 mm

Otology, Micro Ear Surgery – Otologie, Mikro-Ohrchirurgie

Micro Hooks

Mikro-Häkchen

Otology
Otologie



OG011R
0.4 mm



OG012R
0.6 mm



OG013R
0.8 mm



OG014R
1.0 mm



OG080R
1.2 mm



OG081R
1.5 mm



OG082R
2.0 mm



OG083R
2.5 mm

SHAMBAUGH
OG011R-OG083R

90° angled
90° abgewinkelt
160 mm, 6 1/4"

Otology, Micro Ear Surgery – Otologie, Mikro-Ohrchirurgie

Micro Footplate Hooks Mikro-Fußplatten-Häkchen

OG015R
0.2 mm

OG035R
0.4 mm

OG016R
0.6 mm

OG015R-OG035R
PLESTER
90° angled, blunt
90° abgewinkelt, stumpf
160 mm, 6 1/4"

OG021R
1.0 mm
retrograde curved
retrograd gebogen
160 mm, 6 1/4"

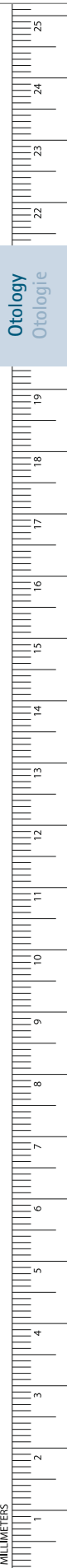

Otology, Micro Ear Surgery – Otologie, Mikro-Ohrchirurgie

Micro Hooks, Micro Scraper, Antrum Hooks

Mikro-Häkchen, Mikro-Schaber, Antrumhäkchen

Otology
Otologie



OG036R 0.4 mm
Micro hook,
slightly angled tip
Mikro-Häkchen,
Arbeitsende leicht
abgewinkelt



HOUGH
OG034R 0.3 mm
Micro hook,
90° angled tip
shaft slightly angled
Mikro-Häkchen,
Arbeitsende 90° abgewinkelt
Schaft leicht abgewinkelt

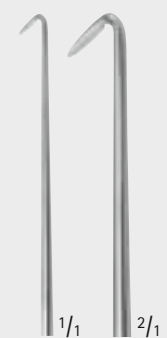

PLESTER
OG023R 2.0 mm
Micro scraper,
60° angled
Mikro-Schaber,
60° abgewinkelt

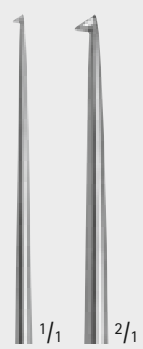

OG031R 0.6 mm
Micro hook,
reverse cutting
Mikro-Häkchen,
retrograd schneidend

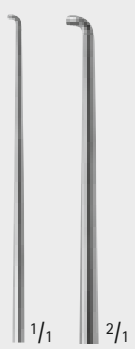

PLESTER
OG037R
Antrum hook,
90° angled
Antrumhäkchen,
90° abgewinkelt



PLESTER
OG038R
Antrum hook,
45° angled
Antrumhäkchen,
45° gebogen

OG023R-OG038R
160 mm, 6 1/4"

Otology, Micro Ear Surgery – Otologie, Mikro-Ohrchirurgie

Application Instrument, Stapes Mobiliser, Micro Knives, Micro Sickle Knives
 Applikationsinstrument, Steigbügelhäkchen, Mikro-Messer, Mikro-Sichelmesser



PLESTER
OG040R

Wire guide and applicator for prostheses with wire loop, flat end
 Applikationsinstrument (Führungsgabel, Stapesreiter) für Stapesprothesen mit Drahtschlinge, Arbeitsende flach
 160 mm, 6 1/4"



HUGHES
OG042R

Stapes mobiliser
 Steigbügelhäkchen
 165 mm, 6 1/2"

OG040R-OG042R



OG100R

Micro knife, straight
 Mikro-Messer, gerade
 160 mm, 6 1/4"



PLESTER
OG101R

Micro sickle knife, slightly curved
 Mikro-Sichelmesser, leicht gebogen
 160 mm, 6 1/4"



THORBURN
OG104R

Micro sickle knife, curved
 Mikro-Sichelmesser, gebogen
 165 mm, 6 1/2"

OG100R-OG104R

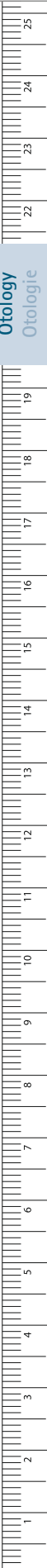

Otology, Micro Ear Surgery – Otologie, Mikro-Ohrchirurgie

Micro Flap Knives, Micro Lancet Knife

Mikro-Lappenmesser, Mikro-Lanzettmesser

Otology
Otologie



OG105R
a x b
2.4 x 3.0 mm



OG106R
a x b
2.4 x 3.5 mm



OG107R
a x b
2.0 x 4.0 mm



OG109R
a x b
2.5 x 4.5 mm

1/1
PLESTER

OG105R-OG109R
Micro flap knives, cutting all around
Mikro-Lappenmesser, rundum schneidend
160 mm, 6 1/4"

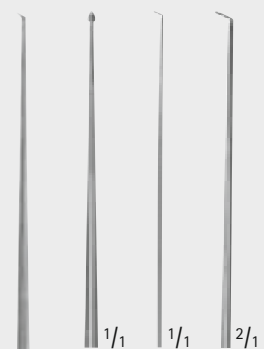

1/1
ROSEN

OG108R
Micro lancet knives
Mikro-Lanzettmesser
160 mm, 6 1/4"



Otology, Micro Ear Surgery – Otologie, Mikro-Ohrchirurgie

Micro Round Cutting Knives

Mikro-Rundmesser



OG125R

Diam. 1.0 mm
Ø 1,0 mm



OG126R

Diam. 1.5 mm
Ø 1,5 mm



OG127R

Diam. 2.0 mm
Ø 2,0 mm



OG128R

Diam. 2.5 mm
Ø 2,5 mm



OG129R

Diam. 3.0 mm
Ø 3,0 mm

OG125R-OG129R

straight
gerade
160 mm, 6 1/4"

Otology
Otologie

MILLIMETERS

Otology, Micro Ear Surgery – Otologie, Mikro-Ohrchirurgie

Micro Round Cutting Knives

Mikro-Rundmesser

Otology
Otologie



OG131R
Diam. 1.0 mm
Ø 1,0 mm



OG133R
Diam. 1.5 mm
Ø 1,5 mm



OG110R
Diam. 2.0 mm
Ø 2,0 mm



OG112R
Diam. 2.6 mm
Ø 2,6 mm



OG132R
Diam. 3.0 mm
Ø 3,0 mm

OG110R-OG133R
45° angled
45° abgewinkelt
160 mm, 6 1/4"

Otology, Micro Ear Surgery – Otologie, Mikro-Ohrchirurgie

Micro Round Cutting Knives, Micro Roller Knives

Mikro-Rundmesser, Mikro-Rollmesser



OG136R

Diam. 1.5 mm
Ø 1,5 mm

OG116R

3 mm
3 mm

OG116R-OG136R

Micro round cutting knives,
90° angled
Mikro-Rundmesser,
90° abgewinkelt
160 mm, 6 1/4"

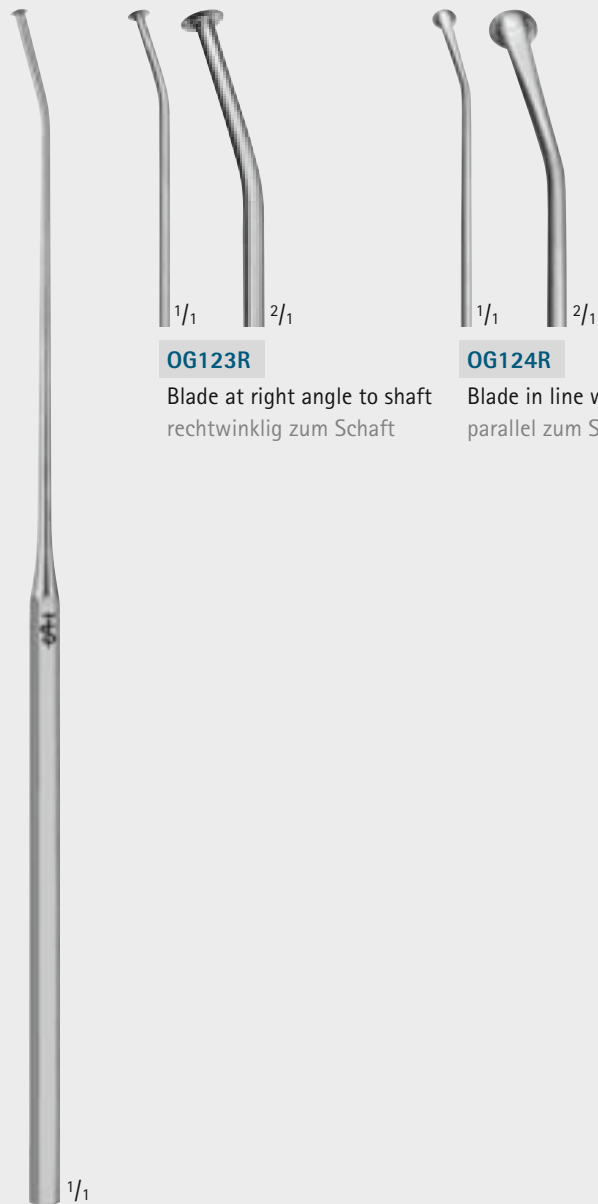

OG123R

Blade at right angle to shaft
rechtwinklig zum Schaft

OG124R

Blade in line with shaft
parallel zum Schaft

SCHUKNECHT

OG123R-OG124R

Micro roller knives
Mikro-Rollmesser
160 mm, 6 1/4"

Otology, Micro Ear Surgery – Otologie, Mikro-Ohrchirurgie

Transplant Holder, Stapes Elevator, Micro Raspatory

Transplantat-Träger, Stapes Elevatorium, Mikro-Raspatorium

Otology
Otologie



1/1

OG048R-OG051R

160 mm, 6 1/4"



1/1 2/1

OG048R

Transplant holder
and raspatory
Transplantat-Träger
und Raspatorium



1/1 2/1

OG050R

Stapes elevator,
slightly angled
Stapes Elevatorium,
leicht abgewinkelt



1/1 2/1

OG051R

Micro raspatory,
round tip, slightly angled
Mikro-Raspatorium,
Spitze rund, leicht aufgebogen

Otology, Micro Ear Surgery – Otologie, Mikro-Ohrchirurgie

Micro Raspatories, Micro Dissectors

Mikro-Raspatorien, Mikro-Dissektoren

OG054R
left curved
nach links gebogen

OG053R
right curved
nach rechts gebogen

OG056R
double left curved
doppelt nach links gebogen

OG055R
double left right
doppelt nach rechts gebogen

OG053-OG056R
Micro raspatories
Mikro-Raspatorien
160 mm, 6 1/4"

OG060R
double left curved
doppelt nach links gebogen

OG061R
double right curved
doppelt nach rechts gebogen

OG060R-OG061R
Micro dissectors
Mikro-Dissektoren
160 mm, 6 1/4"

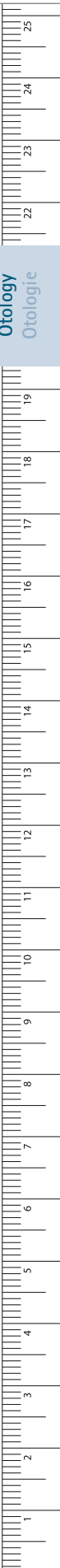

Otology
Otologie

MILLIMETERS

Otology, Micro Ear Surgery – Otologie, Mikro-Ohrchirurgie

Micro Raspatories, Raspatory

Mikro-Raspatorien, Raspatorium

Otology
Otologie

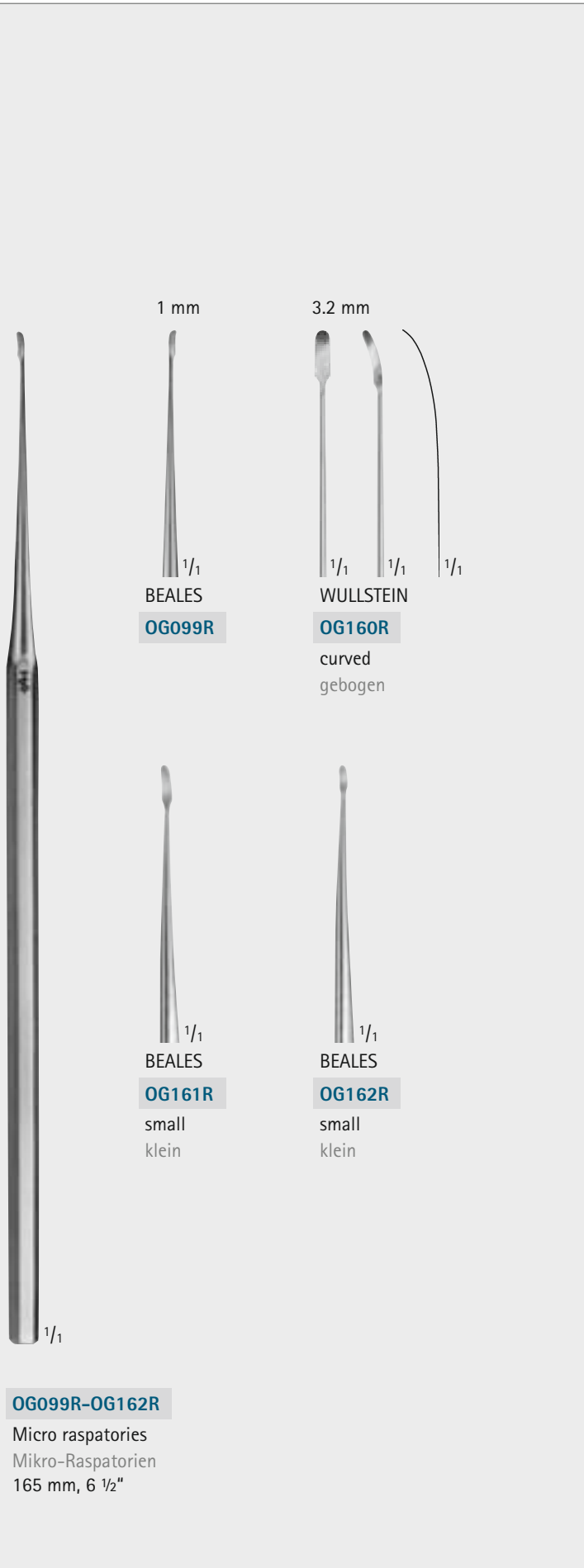

1 mm

BEALES
OG099R

3.2 mm

WULLSTEIN
OG160R
curved
gebogen

BEALES
OG161R
small
klein

BEALES
OG162R
small
klein

OG099R-OG162R

Micro raspatories
Mikro-Raspatorien
165 mm, 6 1/2"

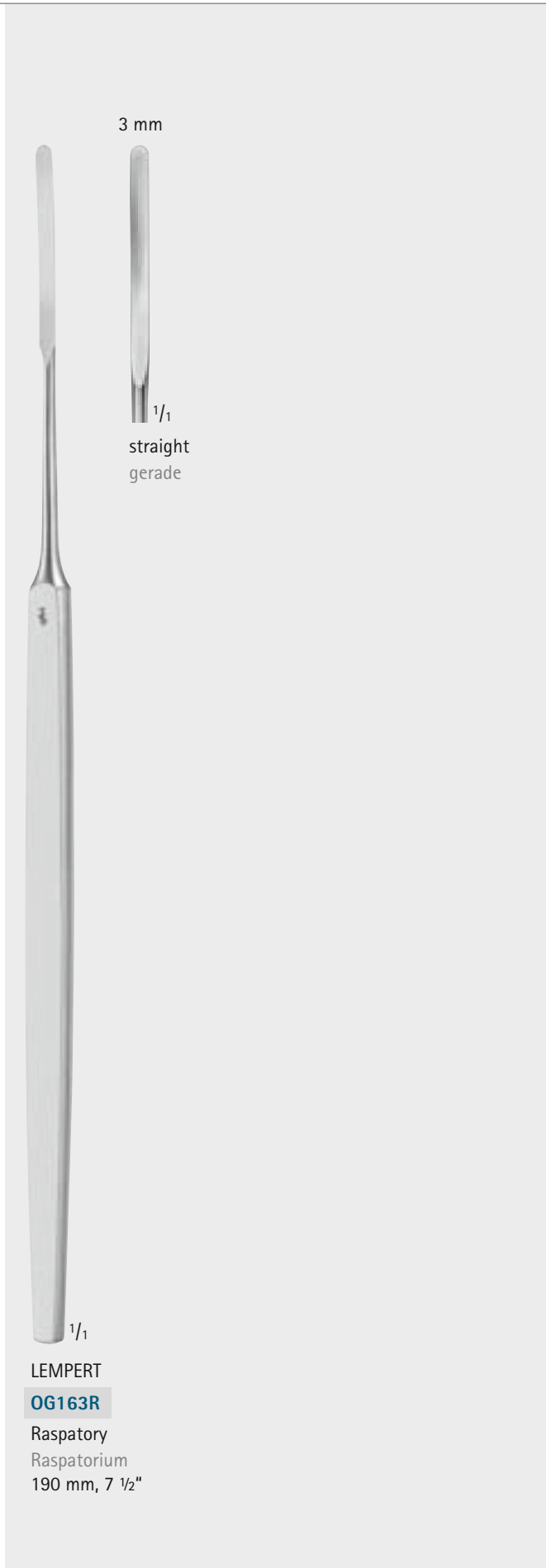

3 mm

1/1
straight
gerade

LEMPERT
OG163R

Raspatory
Raspatorium
190 mm, 7 1/2"

Otology, Micro Ear Surgery – Otologie, Mikro-Ohrchirurgie

Measuring Instruments, Preparation Tray, Vein Graft Press Forceps

Messinstrumente, Präpariertablett, Implantate Presszange



OG140R

Measuring instrument,
marker pins at 3.5 - 4.0 - 4.5 mm
Messinstrument,
Markierungen bei 3,5 - 4,0 - 4,5 mm
160 mm, 6 1/4"



OG141R

Measuring instrument
Messinstrument
165 mm, 6 1/2"



OG145R

92 x 54 mm
Preparation tray,
with mm scale, stainless steel
Präpariertablett aus Metall,
mit mm-Skala

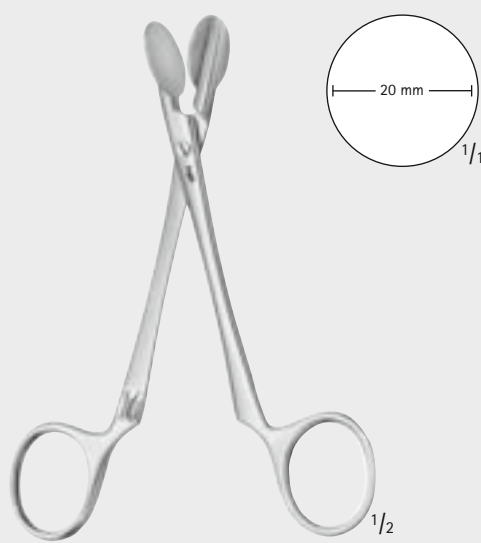

KING

OG066R

Vein graft press forceps,
smooth jaws
Implantate-Presszange,
glattes Maul
140 mm, 5 1/2"

Otology, Micro Ear Surgery – Otologie, Mikro-Ohrchirurgie

Curettes

Scharfe Löffel



Otology
Otologie

2.8 x 3.2 mm

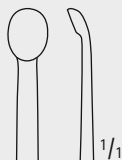

1/2

HOUSE

OG178R

oval cups, large
oval, groß
150 mm, 6"

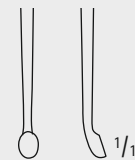

2.6 x 3.5 mm

2.2 x 3.8 mm

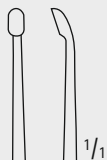

1/2

HOUSE

OG179R

oval cups, extra large
oval, extra groß
150 mm, 6"

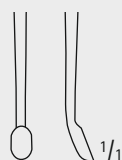

2.8 x 4.8 mm

0.6 x 0.8 mm



1/2

HOUSE

OG186R

oval cups, angled
oval, kniegebogen
150 mm, 6"



0.8 x 1.0 mm

1.5 x 2.5 mm



1/2

SHEA

OG180R

oval cups
oval
160 mm, 6 1/4"

Otology, Micro Ear Surgery – Otologie, Mikro-Ohrchirurgie

Curettes

Scharfe Löffel



1/2

1/1 2/1

HOUSE

Art. No. Art. Nr.	Tip Arbeitsende
OG181R	Diam. 1.0 + 1.2 mm Ø 1,0 + 1,2 mm
OG182R	Diam. 1.5 + 1.8 mm Ø 1,5 + 1,8 mm

oval cups
oval
150 mm, 6"

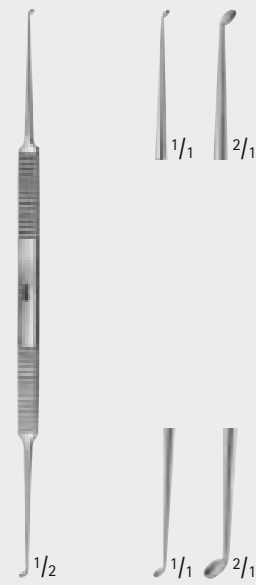

1/2

1/1 2/1

HOUSE

Art. No. Art. Nr.	Tip Arbeitsende
OG184R	Diam. 1.0 + 1.2 mm Ø 1,0 + 1,2 mm
OG185R	Diam. 1.5 + 1.8 mm Ø 1,5 + 1,8 mm

oval cups, strongly angled
oval, stark abgewinkelt
150 mm, 6"



1/2

1/1 2/1

OG189R

angled cups, pointed, large
abgebogen, spitz, groß
170 mm, 6 3/4"

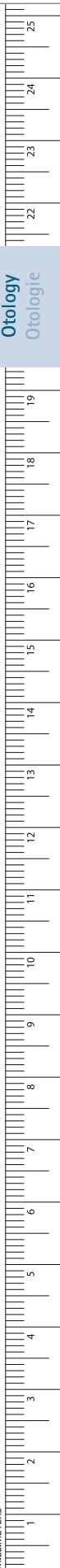

MILLIMETERS

Otology, Micro Ear Surgery – Otologie, Mikro-Ohrchirurgie

Instruments for the Removal of the Stapedial Footplate

Instrumentarium zur Ausmeißelung der Stapes-Fußplatte



Otology
Otologie



1/2

HEERMANN

OG202R-OG207R

180 mm, 7"

0.7 mm



OG202R

Chisel,
very delicate
Flachmeißel,
sehr fein

0.7 mm



OG203R

Gouge,
very delicate
Hohlmeißel,
sehr fein

1.5 mm



OG205R

Gouge
for fenestration
Hohlmeißel
für Fenestration

1.5 mm



OG206R

Gouge
for fenestration
Hohlmeißel
für Fenestration

3 mm



OG207R

Gouge
for fenestration
Hohlmeißel
für Fenestration



1/2

HEERMANN

OG201R

Handle to hold instruments (OG202R - OG207R).
The knurled screw allows fixation in any desired position

Handgriff für die Spezialmeißel (OG202R - OG207R).
Die Meißel können mit der Feststellschraube in jeder Position fixiert werden



1/2

HEERMANN

OG209R

Mallet, metal,
with hollow handle, with narrow head
Metallhammer mit Hohlheft
195 mm, 7 3/4"

Otology, Micro Ear Surgery – Otologie, Mikro-Ohrchirurgie

Suction Cannulas

Saugkanülen



PLESTER

OG970R

Suction set, complete, consisting of:

- OG971R Suction handle with finger cut-off, with LUER cone
- OG973R 2 Suction cannulas, diam. 0.7 mm, with LUER cone
- OG974R 2 Suction cannulas, diam. 1.0 mm, with LUER cone
- OG969R 2 Suction cannulas, diam. 1.3 mm, with LUER cone
- OG982R 2 Suction cannulas, diam. 1.5 mm, with LUER cone
- OG983R 2 Suction cannulas, diam. 2.0 mm, with LUER cone
- OG984R 2 Suction cannulas, diam. 2.5 mm, with LUER cone

Saugset komplett, bestehend aus:

- OG971R Saughandgriff mit Unterbrecher, mit LUER-Konus
- OG973R 2 Saugkanülen, Ø 0,7 mm, mit LUER-Konus
- OG974R 2 Saugkanülen, Ø 1,0 mm, mit LUER-Konus
- OG969R 2 Saugkanülen, Ø 1,3 mm, mit LUER-Konus
- OG982R 2 Saugkanülen, Ø 1,5 mm, mit LUER-Konus
- OG983R 2 Saugkanülen, Ø 2,0 mm, mit LUER-Konus
- OG984R 2 Saugkanülen, Ø 2,5 mm, mit LUER-Konus

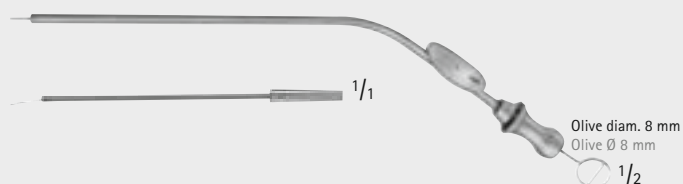

BELLUCCI

OG950R

Suction set, complete, consisting of:

- OG951R Suction tube with finger cut-off and stylet, 155 mm, 6"
- GF772R Detachable end, 20 swg. diam., 1.0 mm diam.
- GF773R Detachable end, 22 swg. diam., 0.7 mm diam.
- GF774R Detachable end, 24 swg. diam., 0.5 mm diam.

Saugset komplett, bestehend aus:

- OG951R Saugrohr, allein, mit Saugunterbrecher und Mandrin, 155 mm, 6"
- GF772R Saugkanüle, Ø 20 swg., Ø 1,0 mm
- GF773R Saugkanüle, Ø 22 swg., Ø 0,7 mm
- GF774R Saugkanüle, Ø 24 swg., Ø 0,5 mm

Otology, Micro Ear Surgery – Otologie, Mikro-Ohrchirurgie

Suction Cannulas, Suction Adapter

Saugkanülen, Saugadapter

Otology
Otologie



ZOELLNER

Art. No. Art. Nr.	Diam. (swg) Ø (swg)	Diam. (mm) Ø mm	Length Länge
GF771R	18	1.2	55 mm, 2 1/4"
GF772R	20	1.0	55 mm, 2 1/4"
GF773R	22	0.7	55 mm, 2 1/4"

detachable tips, fitting GF770R and OG951R

Sales unit:

PAK = Package of 10 pieces

auswechselbare Spitzen zu GF770R und OG951R

Bestelleinheit:

PAK = Packung à 10 Stück

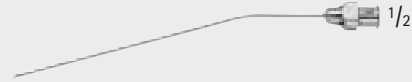

VERHOEVEN

Art. No. Art. Nr.	Diam. (swg) Ø (swg)	Diam. (mm) Ø mm	Length Länge
GF763R	16	1.5	100 mm, 4"
GF764R	18	1.2	100 mm, 4"
GF765R	20	1.0	100 mm, 4"
GF766R	22	0.7	100 mm, 4"

Suction cannulas with LUER cone

Saugkanülen mit LUER-Konus



Olive diam. 7 mm
Olive Ø 7 mm

HOUSE

GF768R

Suction adapter with finger cut-off,

LUER cone / LUER hub

Saugadapter mit Saugunterbrecher,

LUER-Konus / LUER-Bohrung

55 mm, 2 1/8"



Diam. 2.5 mm
Ø 2,5 mm

Olive diam. 8 mm
Olive Ø 8 mm

ZOELLNER

GF770R

Suction cannula, only, with stylet

fitting to the detachable ends GF771R and GF775R

Saugkanüle allein, mit Mandrin,

passend zu den Saugkanülen GF771R und GF775R

180 mm, 7"

- Please find further suction instruments in our separate chapter suction instruments, starting on page 527
- Für weitere Sauginstrumente, siehe Kapitel Sauginstrumente, ab Seite 527

Otology, Micro Ear Surgery – Otologie, Mikro-Ohrchirurgie

Racks for Micro Ear Instrumentes

Rack für Mikro-Ohr-Instrumente

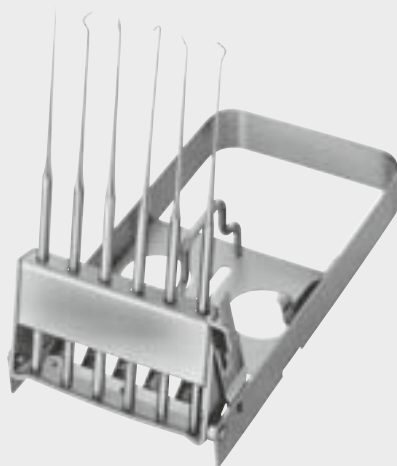

OG150R

Rack for 6 micro ear instruments
with hexagonal or octagonal handle
Rack für 6 Mikro-Ohr-Instrumente
mit Sechs- oder Achtkantgriff

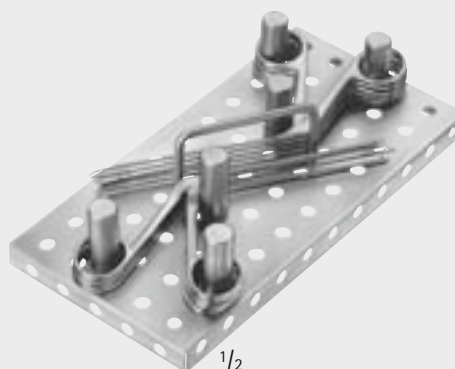

OG320R

Rack for approximately 8 micro ear forceps
with ring handle
Rack für ca. 8 Mikro-Ohr-Ringzängchen

1/2



OG151R

Rack for 12 micro ear instruments
Rack für 12 Mikro-Ohr-Instrumente

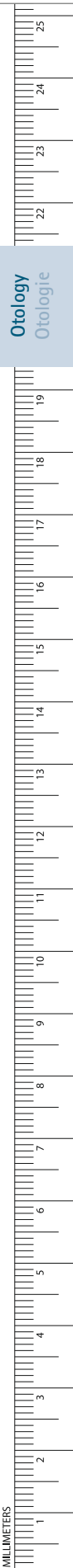

Otology
Otologie

Otology, Micro Ear Surgery – Otologie, Mikro-Ohrchirurgie

Aesculap® Instrument Organisation System

Aesculap® Instrumenten Organisations System

AIOS – The Smile System

Aesculap® Instrument Organisation System



simply a good idea

Our AIOS organisation system is an ingenious way to keep sterile goods organized, making it easy for you to carry out procedures efficiently. This versatile system has been precisely tailored to Aesculap instrument trays and is easy to assemble.

einfache Idee

Mit dem frischen Organisations System AIOS für die Sterilgutversorgung machen wir Ihnen clevere Ordnung und effiziente Vorgänge leicht. Das facettenreiche System ist präzise auf Aesculap Siebkörbe abgestimmt und einfach zu montieren. Die Stege werden in Sekunden einfach mit Pin oder Klammer befestigt. Fertig!



simply protected

Fine (working) tips need to be protected as much as possible. With AIOS, that's no problem at all! This product's soft components, made from latex-free silicone, provide a soft cushion that nevertheless keeps everything firmly in place. The accurately fitting instrument racks, mats with nubs and mesh mats for Aesculap instrument baskets provide ideal storage for these delicate instruments and hold them securely in place.

einfach geschützt

Feine Spitzen und Arbeitsenden brauchen größtmöglichen Schutz. Mit AIOS kein Problem! Die soften Elemente aus latexfreiem Silikon bilden hier ein sanftes und doch fest haltendes Ruhekissen. Die passgenauen Stege, Noppen- und Netzmatten für Aesculap Siebkörbe nehmen die empfindlichen Instrumente auf und lagern sie zuverlässig.



simply good value

Our clever AIOS system shows that instruments can be kept tidy and protected in a cost-effective way. Are you tired of micro scissors with ruined tips, bent spring catches or damaged optics? Then try AIOS!

einfach clever

Dass Instrumentenordnung und -schutz auch clever sein können, zeigen wir mit unserem ausgeklügelten System AIOS. Zerstörte Spitzen von Mikroscheren, verbogene Federgriffe oder zerbrochene Glaskörper in Optiken? Probieren Sie AIOS!



simply organized

With this organisation system for sterile goods tidiness is a given even under difficult storage conditions. AIOS features around 70 elements, which you can combine in any way you like and integrate into Aesculap instrument baskets really easily. So everything is clearly in its place, can be checked at a glance, is well organised and is to hand when needed.

einfach ordentlich

Mit diesem System für die Sterilgutversorgung kommt die Ordnung auch bei schwierigen Lageraufgaben ganz von selbst. Die rund 70 AIOS Elemente können Sie beliebig kombinieren und ganz einfach in Aesculap Siebkörbe integrieren. Da ist alles übersichtlich an seinem Platz, mit einem schnellen Blick zu prüfen, bestens organisiert und damit griffbereit für den Einsatz.

Otology
Otologie

INCHES

Otology, Micro Ear Surgery – Otologie, Mikro-Ohrchirurgie

Aesculap® Instrument Organisation System

Aesculap® Instrumenten Organisations System

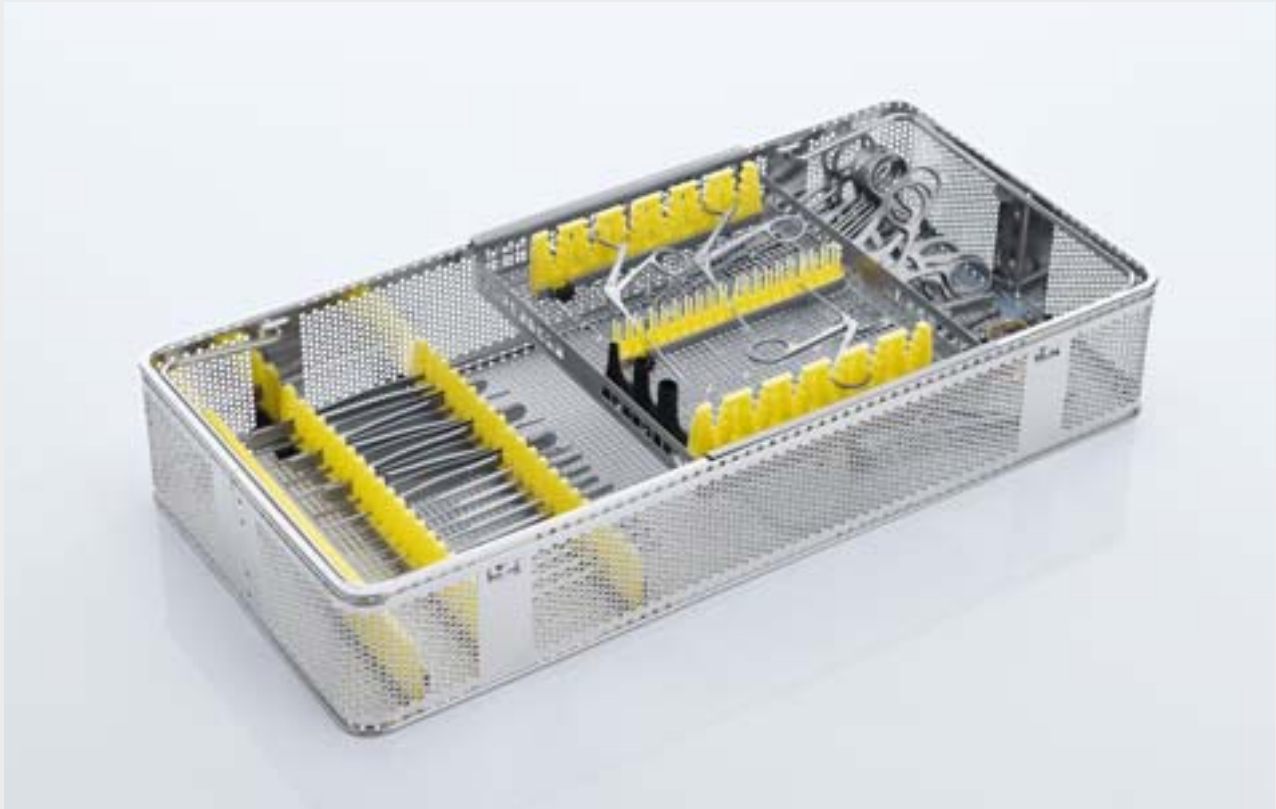

Storage Sample: Tympanoplasty Set

Lagerungsbeispiel: Tympanoplastik-Sieb

For further details see brochure No. C81902

Weitere Informationen siehe Broschüre Nr. C81901

Otology
Otologie

MILLIMETERS

Otology, Micro Ear Surgery – Otologie, Mikro-Ohrchirurgie

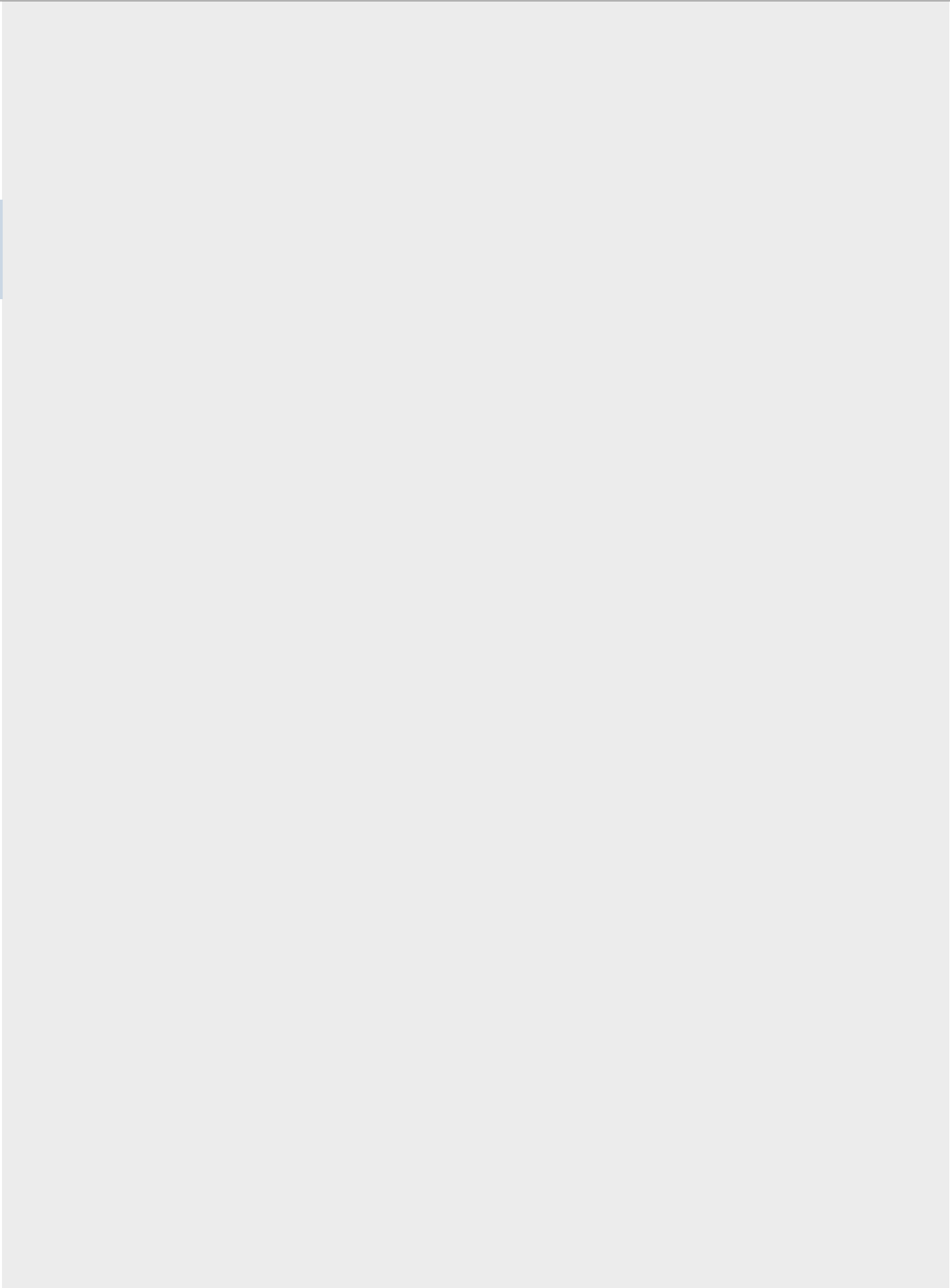
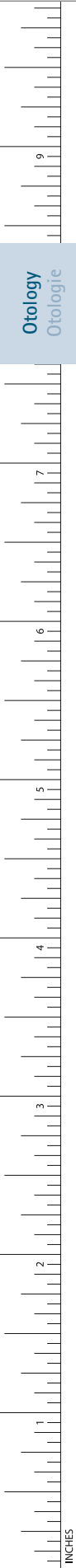

FESS, Rhinology, Rhinoplasty
FESS, Rhinologie, Septum- und Nasenplastik



FESS, Rhinology, Rhinoplasty – FESS, Rhinologie, Septum- und Nasenplastik

Nasal Specula

Nasenspekula

Rhinology
Rhinologie



THUDICHUM (MARK HOVELL)

Art. No. Art. Nr.	Blade size (mm) Blattgröße (mm)	Length Länge
OK161R	6.0 x 8.5	70 mm
OK162R	7.0 x 9.0	71 mm
OK163R	8.0 x 12.5	72 mm
OK164R	8.5 x 15.0	73 mm
OK165R	9.0 x 16.5	74 mm
OK166R	10.0 x 18.0	74 mm
OK167R	10.5 x 19.5	75 mm

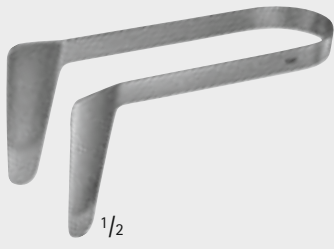
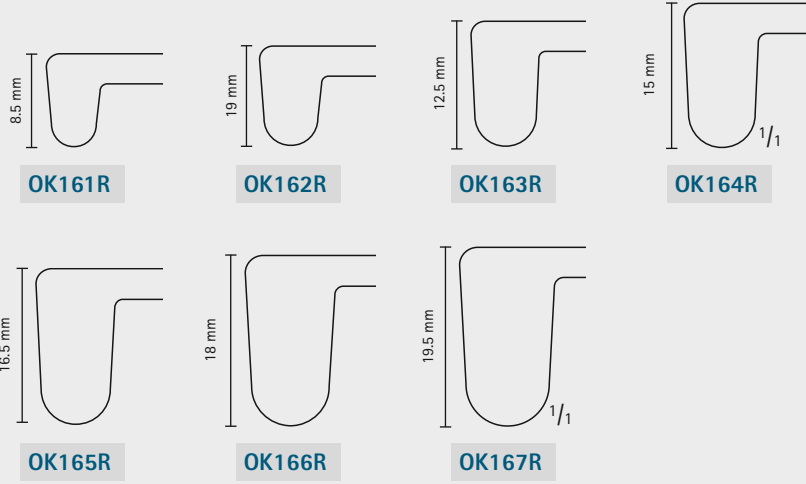

ST CLAIR THOMPSON

OK070R-OK073R

75 mm, 3"

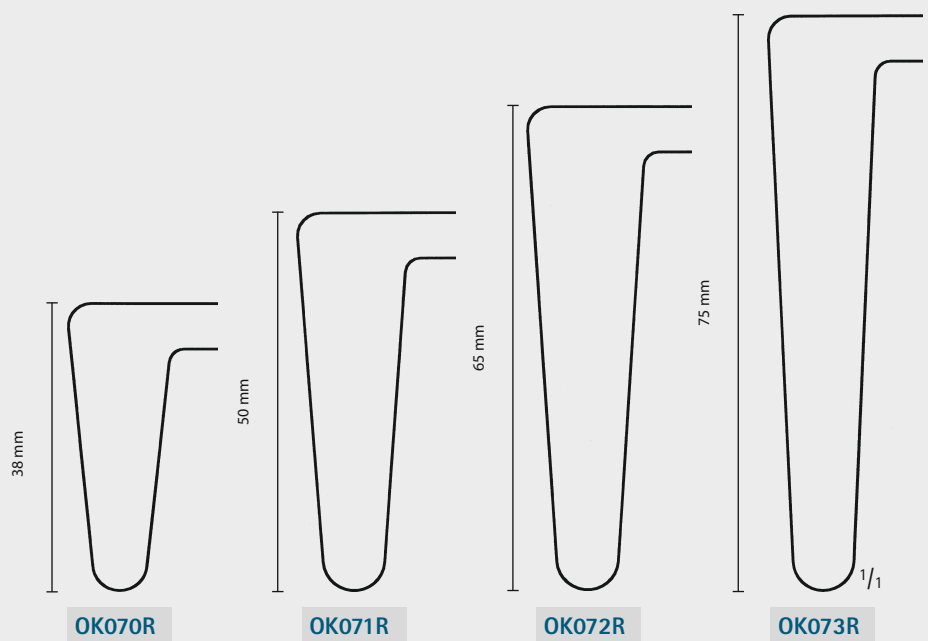

INCHES

FESS, Rhinology, Rhinoplasty – FESS, Rhinologie, Septum- und Nasenplastik

Nasal Specula

Nasenspekula

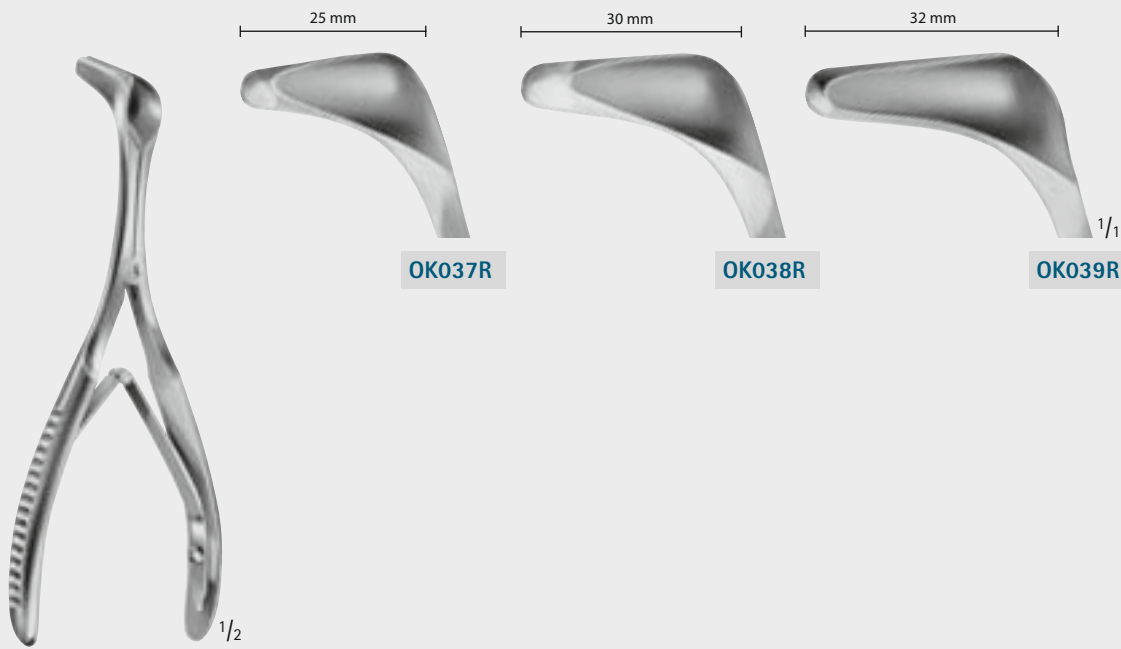

HARTMANN-HALLE

OK037R-OK039R

aseptic joint
mit Steckschluss
155 mm, 6 1/8"

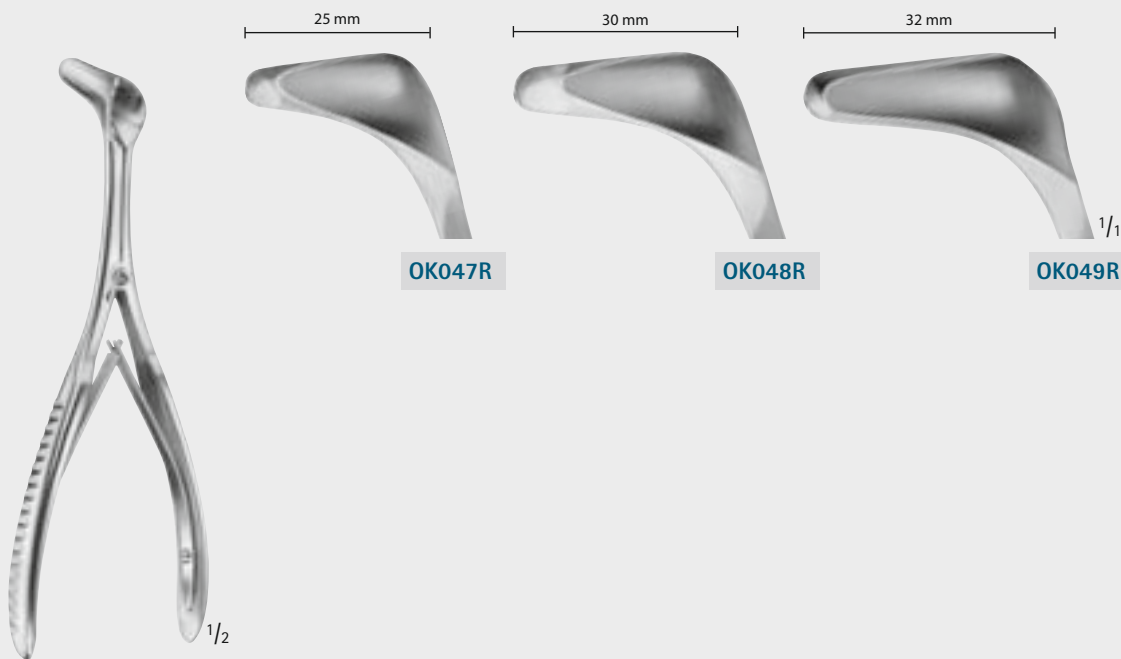

HARTMANN-HALLE

OK047R-OK049R

screw joint
mit Schraubschluss
155 mm, 6 1/8"

Rhinology
Rhinologie

MILLIMETERS

FESS, Rhinology, Rhinoplasty – FESS, Rhinologie, Septum- und Nasenplastik

Nasal Specula

Nasenspekula

Rhinology
Rhinologie



TIECK-HALLE
OK051R-OK052R
screw joint, for use in infants,
curved sidwards
mit Schraubschluss, Kindermodell,
seitwärts gebogen
135 mm, 5 1/4"

BECKMANN
OK053R
screw joint, for use in infants,
curved sidwards
mit Schraubschluss, Kindermodell,
seitwärts gebogen
140 mm, 5 1/2"

BECKMANN
OK058R
screw joint, curved sidwards
mit Schraubschluss,
seitwärts gebogen
150 mm, 6"

FESS, Rhinology, Rhinoplasty – FESS, Rhinologie, Septum- und Nasenplastik

Nasal Specula

Nasenspekula

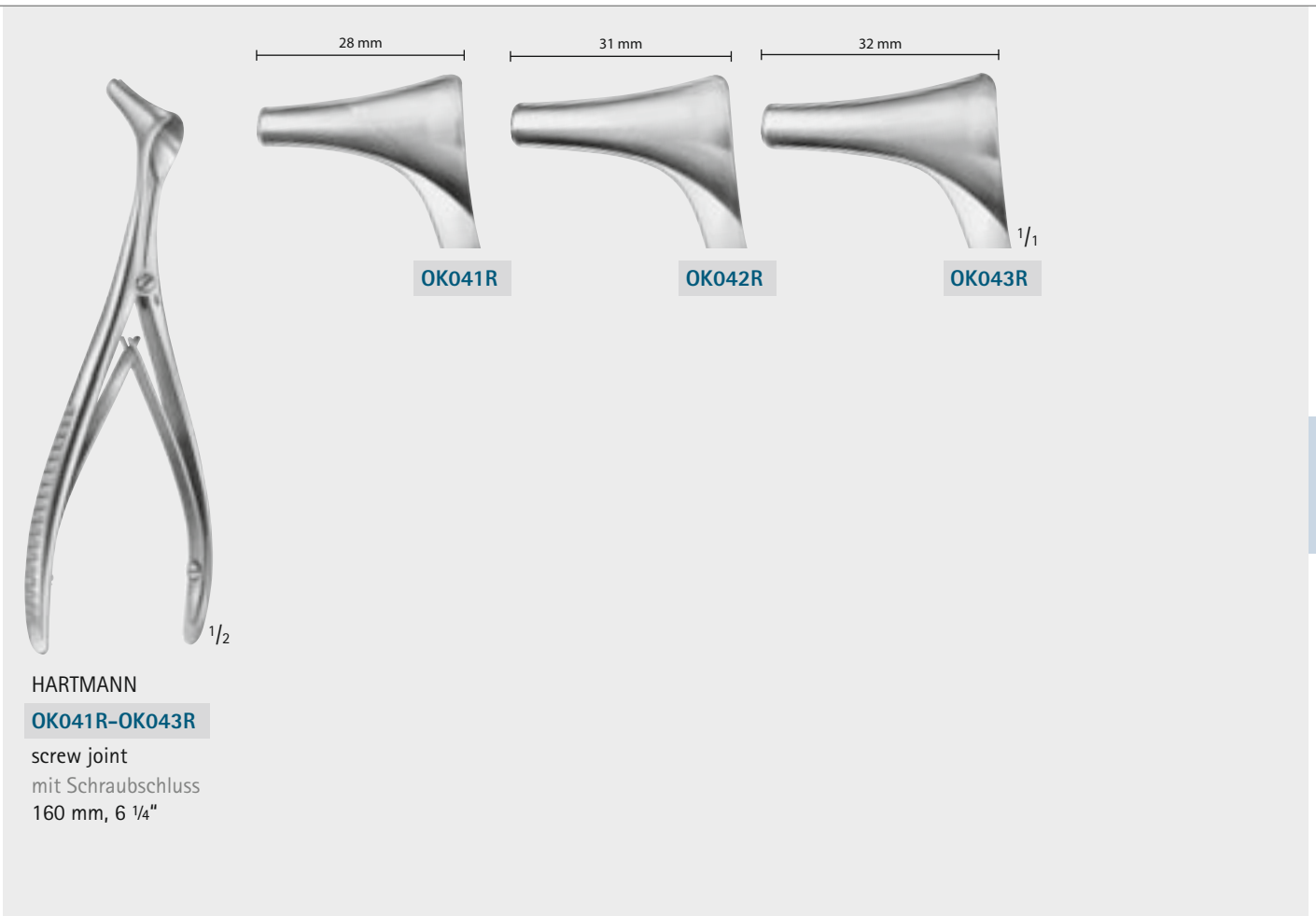

HARTMANN

OK041R-OK043R

screw joint
mit Schraubschluss
160 mm, 6 1/4"

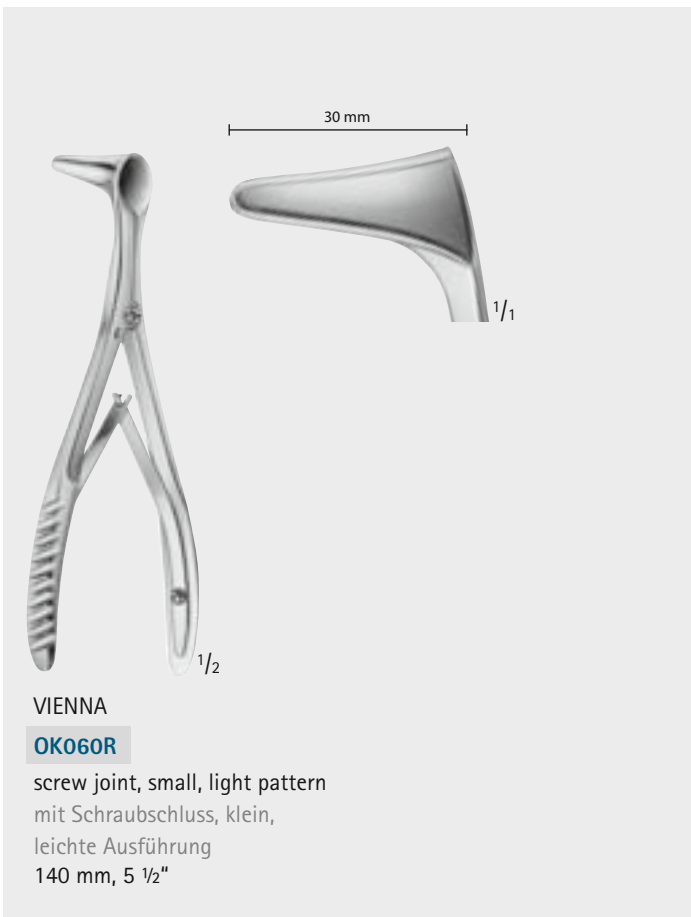

VIENNA

OK060R

screw joint, small, light pattern
mit Schraubschluss, klein,
leichte Ausführung
140 mm, 5 1/2"

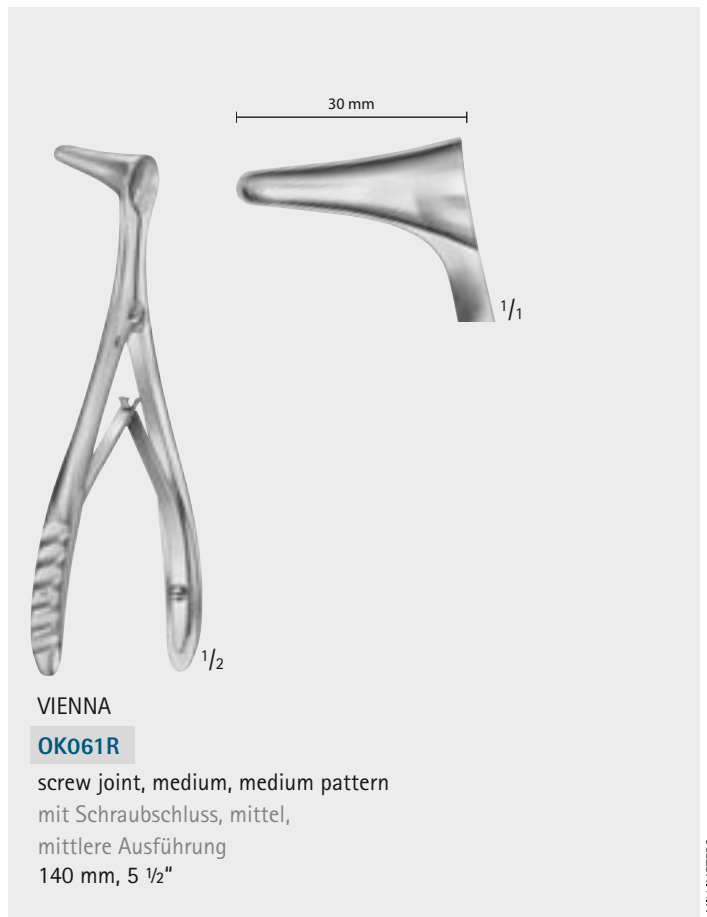

VIENNA

OK061R

screw joint, medium, medium pattern
mit Schraubschluss, mittel,
mittlere Ausführung
140 mm, 5 1/2"

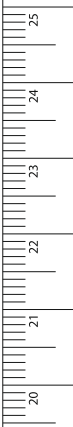

Rhinology
Rhinologie



MILLIMETERS

FESS, Rhinology, Rhinoplasty – FESS, Rhinologie, Septum- und Nasenplastik

Nasal Specula

Nasenspekula

Rhinology
Rhinologie

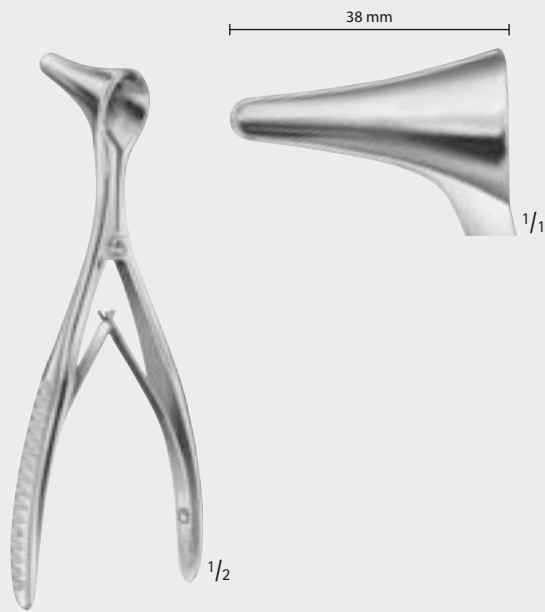

VIENNA

OK062R

screw joint, large, heavy
pattern

mit Schraubschluss, groß,
schwere Ausführung

140 mm, 5 1/2"



HARTMANN

OK030R

light pattern

leichtes Modell

145 mm, 5 3/4"

FESS, Rhinology, Rhinoplasty – FESS, Rhinologie, Septum- und Nasenplastik

Nasal Specula

Nasenspekula

Rhinology
Rhinologie

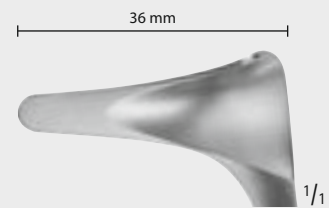

OK081R, OK091R

Fig. 1

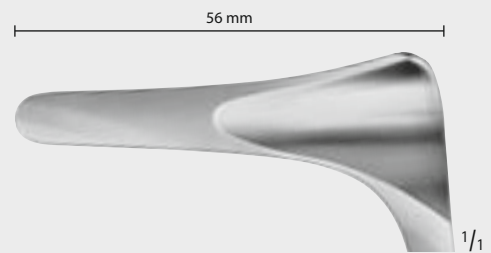

OK082R, OK092R

Fig. 2

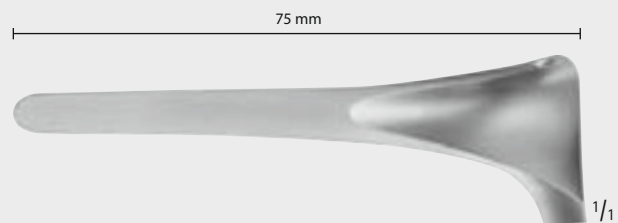

OK083R, OK093R

Fig. 3

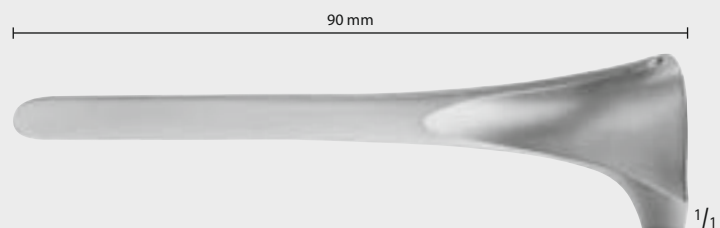

OK084R, OK094R

Fig. 4



KILLIAN

OK081R-OK084R

aseptic joint
mit Steckschluss
140 mm, 5 1/2"



KILLIAN

OK091R-OK094R

screw joint
mit Schraubschluss
145 mm, 5 3/4"

MILLIMETERS

FESS, Rhinology, Rhinoplasty – FESS, Rhinologie, Septum- und Nasenplastik

Nasal Specula

Nasenspekula

Rhinology
Rhinologie

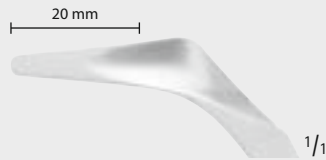

OK105R

Fig. 1

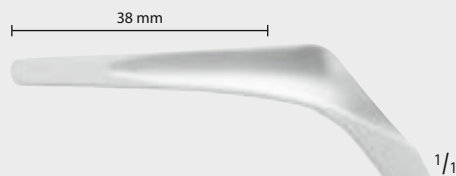

OK106R

Fig. 2

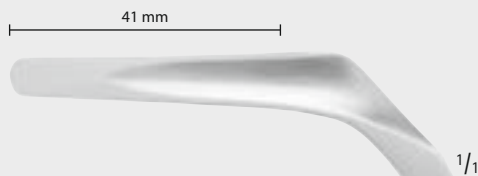

OK107R

Fig. 3

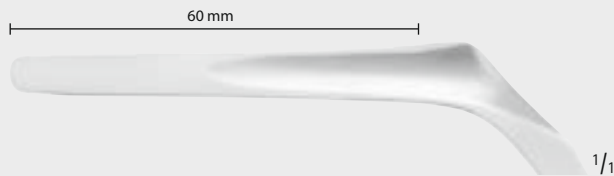

OK108R

Fig. 4

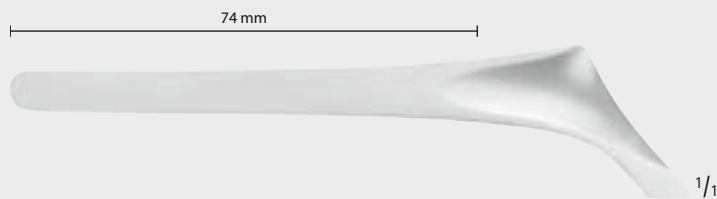

OK090R

Fig. 5



COTTLE

OK090R-OK108R

aseptic joint and set-screw,
with extra thin blades
mit Steckschluss und Stellschraube,
mit besonders schlanken Blättern
135 mm, 5 1/4"

FESS, Rhinology, Rhinoplasty – FESS, Rhinologie, Septum- und Nasenplastik

Nasal Specula

Nasenspekula

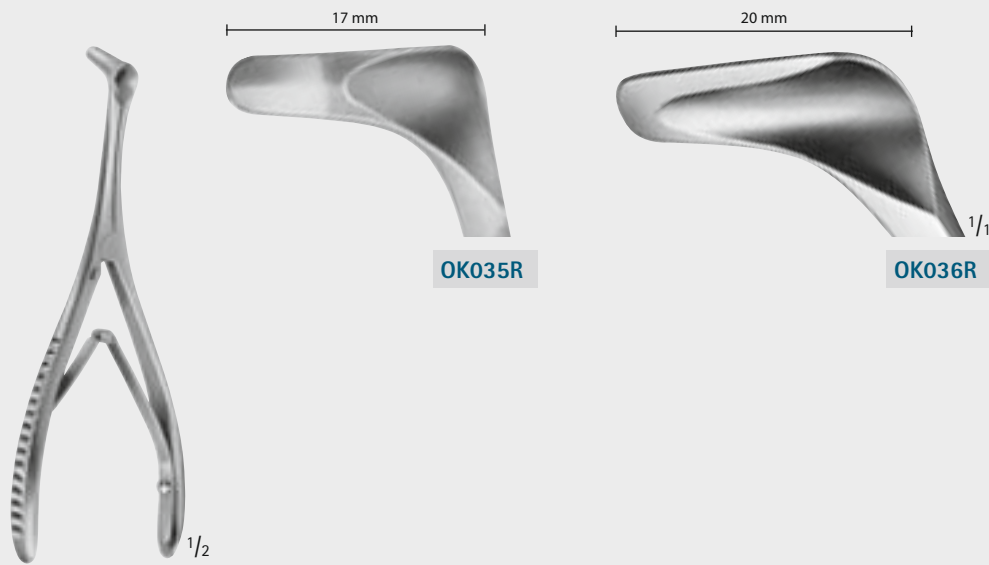

TIECK-HALLE

OK035R-OK036R

aseptic joint, for use in infants
mit Steckschluss, Kindermodelle
135 mm, 5 1/4"

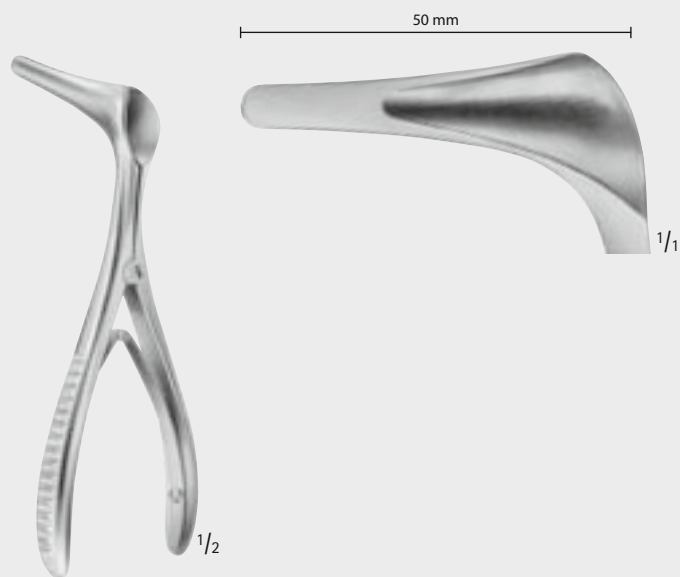

COTTLE

OK085R

slightly tapered blades
leicht spitz zulaufend
135 mm, 5 1/4"

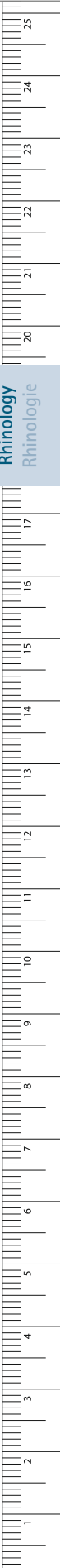

MILLIMETERS

FESS, Rhinology, Rhinoplasty – FESS, Rhinologie, Septum- und Nasenplastik

Nasal Specula, Light Guide Cables, Adapter

Nasenspekula, Lichtleitkabel, Adapter

Rhinology
Rhinologie

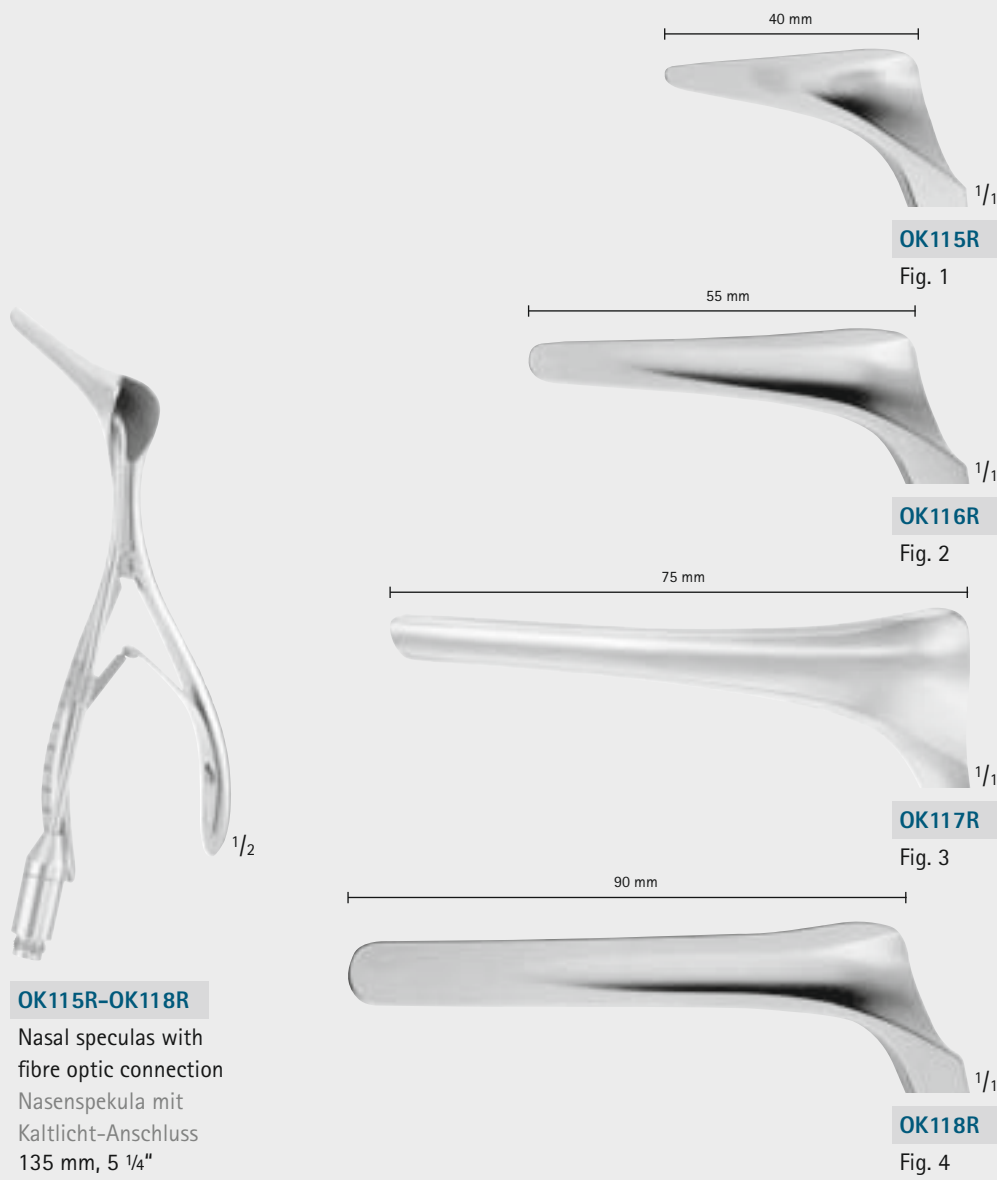

OK115R-OK118R
Nasal speculas with fibre optic connection
Nasenspekula mit Kaltlicht-Anschluss
135 mm, 5 1/4"

OK115R

Fig. 1

OK116R

Fig. 2

OK117R

Fig. 3

OK118R

Fig. 4



Art. No. Art. Nr.	Description Beschreibung	Length (cm) Länge (cm)
OP923	Full HD light guide cable Full HD Lichtleitkabel	250
OP906		180
OP913		250
OP914		350

Light guide cables, autoclavable, diam. 4.8 mm
Lichtleitkabel, autoklavierbar, Ø 4,8 mm



Art. No. Art. Nr.	Description Beschreibung
TE683R	Olympus
TE684R	Wolf
TE688R	Olympus-Xenon

Light guide cables adapter for light source of other manufacturers
Lichtleitkabel-Adapter für Lichtquelle anderer Hersteller

- For suitable Aesculap light sources see brochure C47602.
- Passende Aesculap Lichtquellen finden Sie in unserem Prospekt C47601.

FESS, Rhinology, Rhinoplasty – FESS, Rhinologie, Septum- und Nasenplastik

Nasal Specula

Nasenspekula

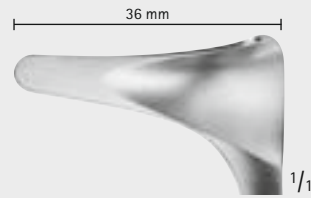

OK076R

Fig. 1

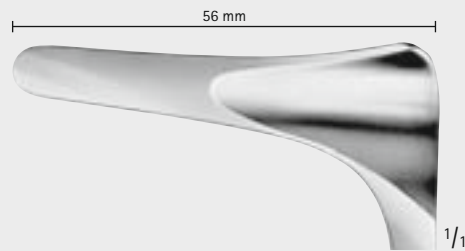

OK077R

Fig. 2

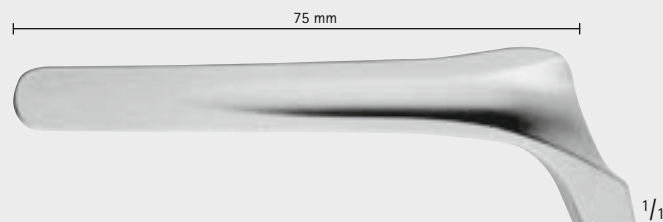

OK078R

Fig. 4



1/2

OK076R-OK078R

with connection to Aesculap® Unitrac®
 retraction and holding arm
 mit Adapter für Aesculap® Unitrac®
 Retraktions- und Haltearm
 145 mm, 5 3/4"

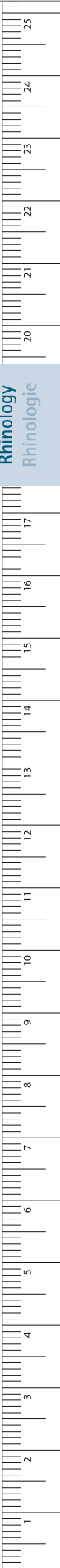

FESS, Rhinology, Rhinoplasty – FESS, Rhinologie, Septum- und Nasenplastik

Unitrac®

Unitrac®

Rhinology
Rhinologie



RT040R

Unitrac® – Pneumatic Holding Arm

- Single handed use
- Fast sterile set-up in the OR
- Simple to assemble onto the OR table railing
- Integrated safety systems prevent collapse of holding arm if OR compressed air supply is interrupted
- Direct connection to OR compressed air supply or to CO₂ cartridge
- Holding force: 4 kg

Unitrac® – Pneumatischer Haltearm

- Einhand-Bedienung
- Schnelle, sterile Bereitstellung im OP
- Einfache Montage an OP-Schiene
- Integrierte Sicherheitssysteme verhindern ein Kollabieren des Haltearms bei möglichem Ausfall der OP-Druckluftversorgung
- Direkter Anschluss an die vorhandene OP-Druckluftversorgung oder die CO₂ Druckluft-Kartusche
- Haltekraft: 4 kg



RT043R

CO₂ air cartridge adapter for use of Unitrac®, independent from compressed air sources
CO₂ Kartuschenadapter für den Einsatz des Unitrac®, unabhängig von einem Druckluftanschluss



RT044SU

Unitrac® CO₂ air cartridge

Sales unit:

PAK = Package of 10 pieces, Single Use

Unitrac® CO₂ Druckluftkartusche

Bestelleinheit:

PAK = Packung à 10 Stück, Single Use

Unitrac® Air Cartridge: the hose-less „Plug and Play“ solution for Unitrac®

- No need for laying hoses
- Avoid tripping hazard in the OR
- Always constant working pressure
- Overload valve secured
- Fast and easy change of cartridges

Die Schlauchlose „Plug and Play“ Lösung für Unitrac®

- Einsatz des Unitrac® unabhängig von einem Druckluftanschluss
- Vermeidet dadurch Stolperfallen im Operationssaal
- Gewährt konstanten Betriebsdruck
- Sicher durch Überdruckventil
- Schneller und einfacher Kartuschenwechsel



RT090R

Flexible fixing element with sprocket, suitable for RT040R and FF168R

Flexible Verbindungsklemme zur OP-Schiene, passend für RT040R und FF168R

1/1

FESS, Rhinology, Rhinoplasty – FESS, Rhinologie, Septum- und Nasenplastik

Unitrac®
Unitrac®



JG901

Sterile drape for coverage of the Unitrac® arms, Single Use
Sales unit:

PAK = Package of 50 pieces

Steriler Überzug für den Unitrac® Haltearm, Einmalgebrauch
Bestelleinheit:

PAK = Packung à 50 Stück



RT020R

Quick connect adapter for use with sterile drape JG901.
Allows the change of instruments after draping with JG901

Schnellverschluss Adapter für die Verwendung mit dem Sterilüberzug JG901. Ermöglicht den Instrumentenwechsel nach dem Abdecken mit JG901



Unitrac® in combination with MINOP® TREND
Unitrac® in Verbindung mit MINOP® TREND

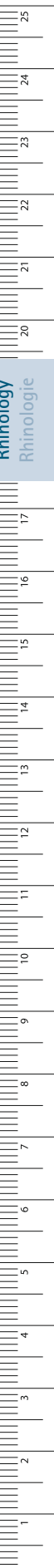
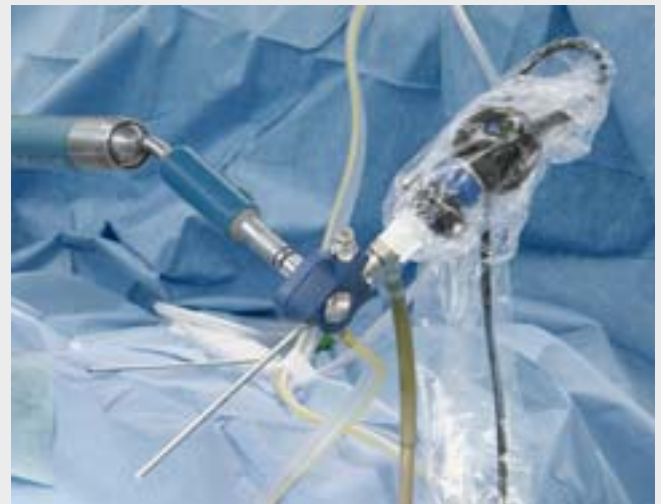

Rhinology
Rhinologie

MILLIMETERS

FESS, Rhinology, Rhinoplasty – FESS, Rhinologie, Septum- und Nasenplastik

M-TRAC – Mechanical Holding Arm

M-TRAC – Mechanischer Haltearm



FF168R

M-TRAC Mechanical Holding Arm

- Flexible holding device with mechanical fixation
- Total length: 107 cm
- Total weight: 0.7 kg
- Holding force: 4 kg
- Small, flexible joints for fine positioning
- Autoclavable 134°C, 5 minutes

M-TRAC Mechanischer Haltearm

- Flexibles Haltesystem mit mechanischer Fixierung
- Gesamtlänge: 107 cm
- Gesamtgewicht: 0,7 kg
- Haltekraft: 4 kg
- Kleine, flexible Gelenke für präzises Positionieren
- Autoklavierbar 134°C, 5 Minuten

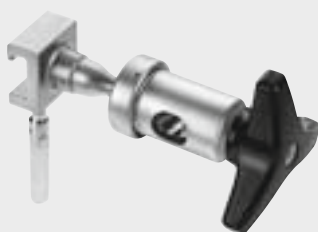

FF280R

Flexible fixing element with ball joint, suitable for FF168R

Flexible Verbindungsklemme mit Kugelgelenk, passend FF168R

FESS, Rhinology, Rhinoplasty – FESS, Rhinologie, Septum- und Nasenplastik

MINOP® TREND

MINOP® TREND



Rhinology
Rhinologie



FH615

Handle with irrigation button for FH610R and FH611R. Ergonomic grasping part
Handgriff mit Spülknopf für FH610R und FH611R. Ergonomischer Handgriff



RT099R

Adapter for Aesculap holding arm and FH615
Adapter für Aesculap Haltearm und FH615



FH605SU

Suction and irrigation tube, sterile, 4.5 m with 2 puncture needles for handle FH615 and FH610R/FH611R

Sales unit: PAK = Package of 10 tubes

Spül-/Saugschlauch, steril, 4,5 m, mit 2 Punk-
tionskanülen für Griff FH615 und FH610R/FH611R
Bestelleinheit: PAK = Packung à 10 Schlauchsets

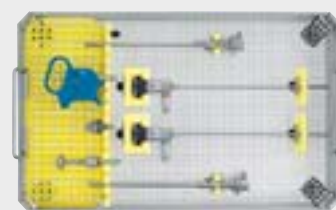

FF357R

Storage tray with silicone padding and lid for all MINOP® TREND components (without instruments)

Lagerungstray mit Silikon-Lagerungsstegen und Deckel
für alle MINOP® TREND Komponenten (ohne Inhalt)

MILLIMETERS

FESS, Rhinology, Rhinoplasty – FESS, Rhinologie, Septum- und Nasenplastik

Suction and Irrigation Trocars, Endoscopes

Saug- und Spültrocare, Endoskope



Rhinology
Rhinologie



FH610R

Suction and irrigation trocar for 0° endoscope PE487A,
diam. 4.5 / 6.0 mm
Spül-/Saugtrokar für 0°-Endoskop PE487A,
Ø 4,5 / 6,0 mm
120 mm , 4 3/4"

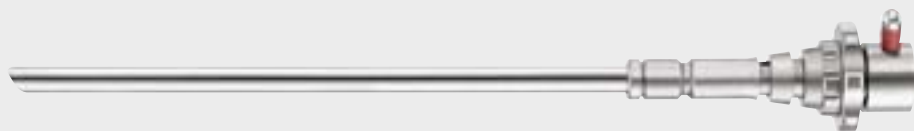

FH611R

Suction and irrigation trocar for 30° endoscope PE507A,
diam. 4.5 mm / 6.0 mm
Spül-/Saugtrokar für 30°-Endoskop PE507A,
Ø 4,5 mm / 6,0 mm
120 mm, 4 3/4"

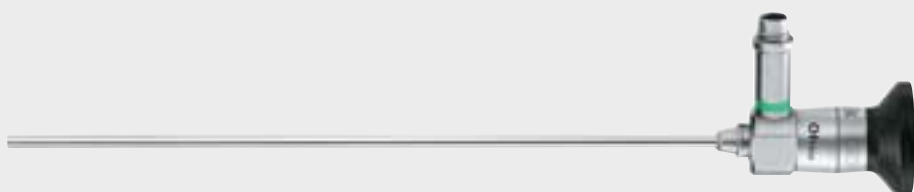

PE487A

Endoscope, 0° viewing angle, diam. 4.0 mm
Endoskop, Blickrichtung: 0°, Ø 4,0 mm
200 mm, 7 7/8"

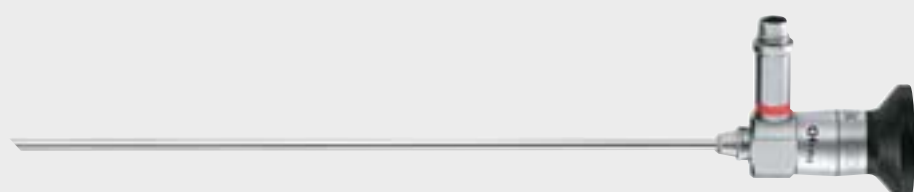

PE507A

Endoscope, 30° viewing angle, diam. 4.0 mm
Endoskop, Blickrichtung: 30°, Ø 4,0 mm

- For further endoscopes and endo units see Aesculap brochure C46702.
- Weitere Endoskope und Endoskopie-Einheiten finden Sie im Aesculap Prospekt C46701.

FESS, Rhinology, Rhinoplasty – FESS, Rhinologie, Septum- und Nasenplastik

Nasal Scissors, Micro Scissors

Nasenscheren, Mikro-Schere



- The LUER-Lock flushing ports of tubular shaft instruments allow easy cleaning of the instruments as well as lubrication with a steam permeable oil (e.g. Aesculap Sterilit®).
- Die LUER-Lock Spülanschlüsse bei Rohrschaft Instrumenten ermöglichen eine einfache Reinigung der Instrumente, sowie die Pflege mit einem dampfdurchlässigen Öl (z.B. Aescuclap Sterilit®).

130 mm, 5 1/8"

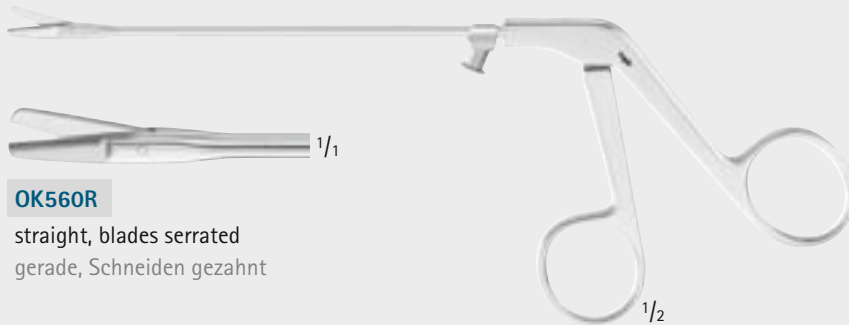

OK560R

straight, blades serrated
gerade, Schneiden gezahnt



OK561R

left curved, blades serrated
links gebogen, Schneiden gezahnt



OK562R

right curved, blades serrated
rechts gebogen, Schneiden gezahnt

OK560R-OK562R

Nasal scissors
Nasenscheren

115 mm, 4 1/2"



CASPAR

FD228R

Micro scissors, curved rotatable 360°, detachable for cleaning
Mikro-Schere, gebogen, 360° drehbar, zerlegbar zur Reinigung



Rhinology
Rhinologie

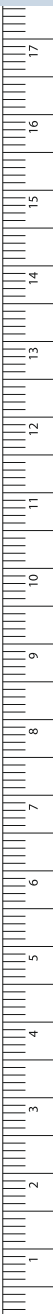

MILLIMETERS

FESS, Rhinology, Rhinoplasty – FESS, Rhinologie, Septum- und Nasenplastik

Antrum Punches

Antrumstanzen

Rhinology
Rhinologie

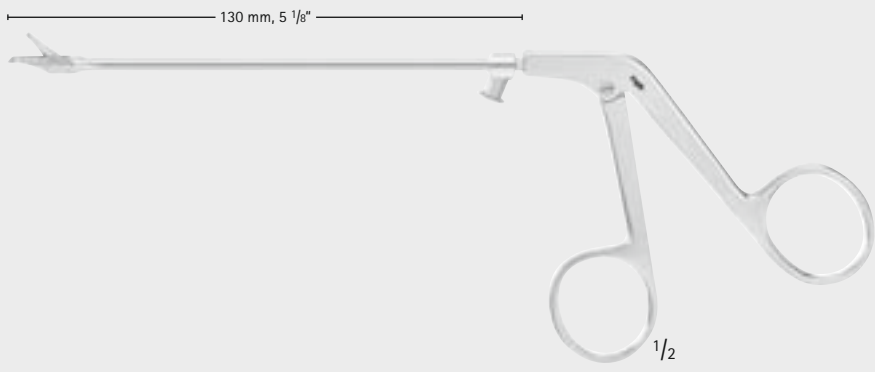

		1/1 6 x 1.5 mm	1/1 8 x 3 mm	1/1 11.5 x 3.5 mm
	straight gerade	OK608R forward through cutting nach vorne durchschneidend	MACKAY-GRUNEWALD OK602R forward through cutting nach vorne durchschneidend	MACKAY-GRUNEWALD OK603R forward through cutting nach vorne durchschneidend
	45° upwards angled 45° nach oben gebogen	OK609R forward through cutting nach vorne durchschneidend	MACKAY-GRUNEWALD OK606R forward through cutting nach vorne durchschneidend	MACKAY-GRUNEWALD OK607R forward through cutting nach vorne durchschneidend

OK602R-OK609R

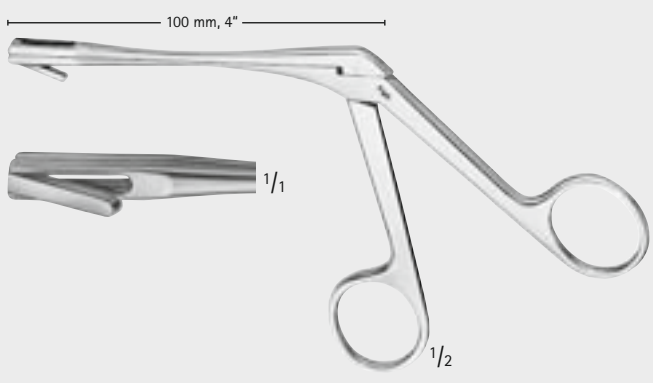

OSTROM
OK704R
reverse action jaw
rückwärts schneidend

INCHES

FESS, Rhinology, Rhinoplasty – FESS, Rhinologie, Septum- und Nasenplastik

Antrum Punches

Antrumstanzen

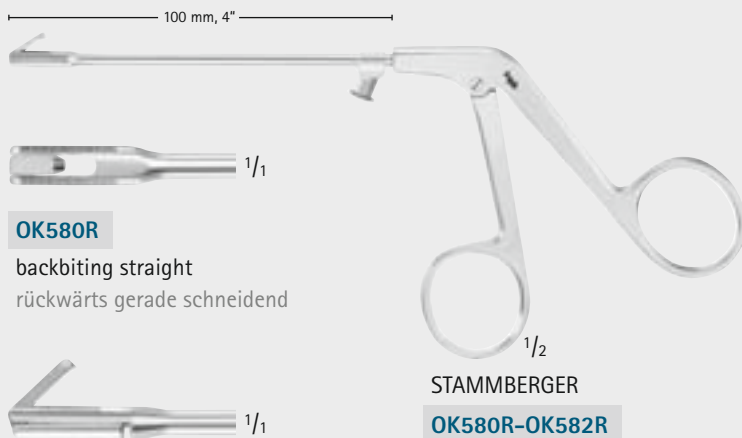

OK580R

backbiting straight
rückwärts gerade schneidend



OK581R

backbiting to the right
rückwärts nach rechts schneidend



OK582R

backbiting to the left
rückwärts nach links schneidend

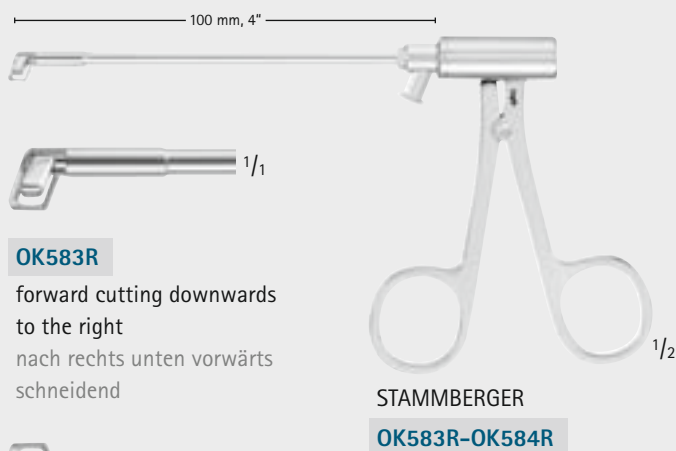

OK583R

forward cutting downwards
to the right
nach rechts unten vorwärts
schneidend



OK584R

forward cutting downwards
to the left
nach links unten vorwärts
schneidend

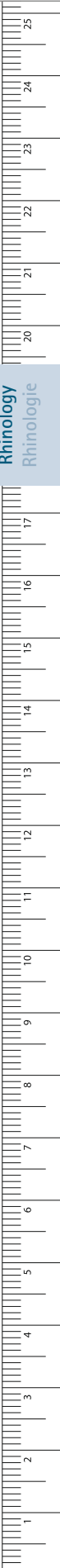

FESS, Rhinology, Rhinoplasty – FESS, Rhinologie, Septum- und Nasenplastik

Giraffe Forceps

Giraffenzangen

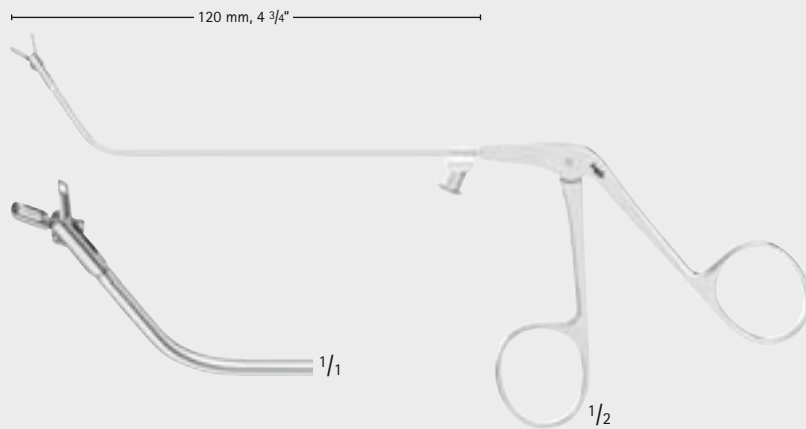

OK620R

upwards curved, cup size diam. 3 mm, double action
aufwärts gebogen, Löffelgröße Ø 3 mm, doppel beweglich

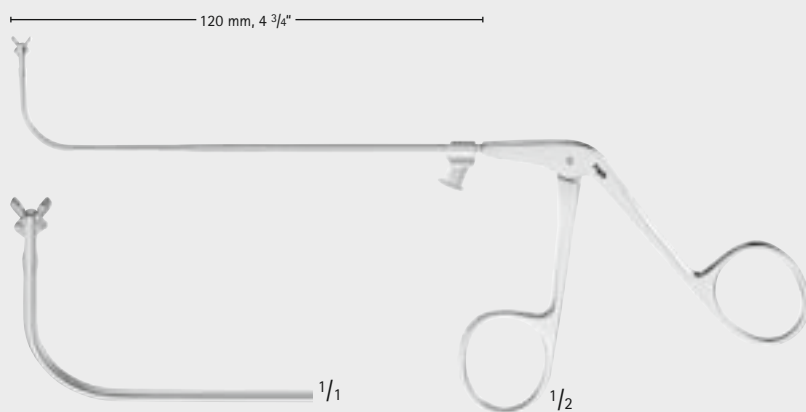

OK621R

strongly upwards curved, cup size diam. 2 mm, double action
stark aufwärts gebogen, Löffelgröße Ø 2 mm, doppel beweglich

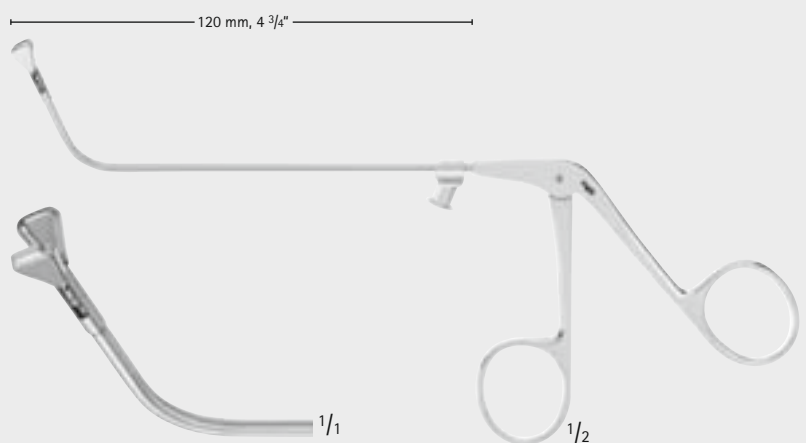

OK622R

upwards curved, jaw size 4 x 6 mm, double action
aufwärts gebogen, Maulgröße 4 x 6 mm, doppel beweglich

FESS, Rhinology, Rhinoplasty – FESS, Rhinologie, Septum- und Nasenplastik

Antrum Grasping Forceps

Antrum Fassungszangen

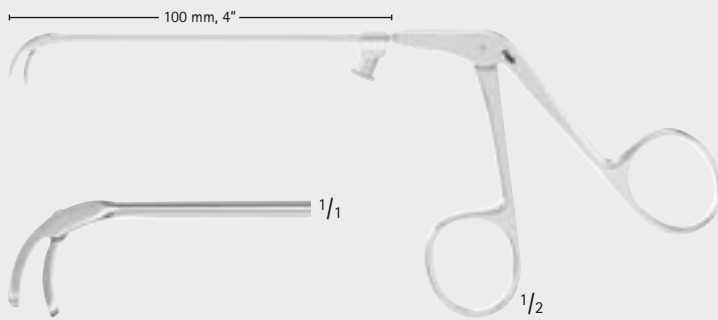

OK680R

jaw opening backwards, curved downwards
rückwärts öffnend, nach unten gebogen

OK680R-OK683R



OK681R

jaw opening backwards, curved upwards
rückwärts öffnend, nach oben gebogen



OK682R

jaw opening backwards, curved to right
rückwärts öffnend, nach rechts gebogen



OK683R

jaw opening backwards, curved to left
rückwärts öffnend, nach links gebogen

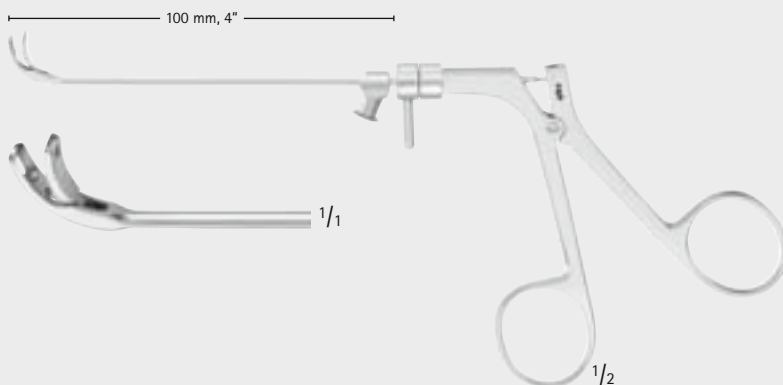

OK684R

jaw opening backwards, jaw 360° rotatable
rückwärts öffnend, Maul 360° drehbar

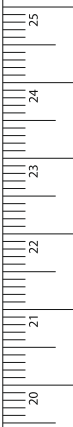

Rhinology
Rhinologie



MILLIMETERS

FESS, Rhinology, Rhinoplasty – FESS, Rhinologie, Septum- und Nasenplastik

Nasal Cutting Forceps

Conchotome



- Sliding shaft instruments can be disassembled for cleaning and maintenance.
- Bei Schiebenschaft Instrumenten werden Reinigung und Pflege durch Zerlegen ermöglicht.

Rhinology
Rhinologie

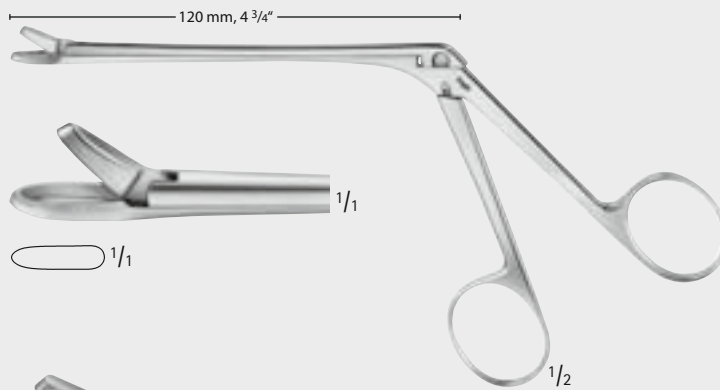

MYLES

OK600R

through cutting
durchschneidend

GRUENWALD-HENKE

OK612R-OK613R

through cutting
durchschneidend



HARTMANN

OK641R-OK644R

through cutting
durchschneidend



SCHMEDEN

OK646R-OK647R

through cutting
durchschneidend

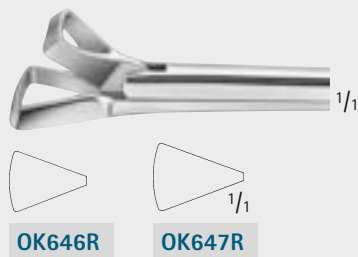

STRUYCKEN

OK690R

through cutting
durchschneidend



INCHES

FESS, Rhinology, Rhinoplasty – FESS, Rhinologie, Septum- und Nasenplastik

Septum Forceps

Septumzangen

LUC

OK433R-OK434R

with fenestrated jaws
gefenstert
200 mm, 7 7/8"

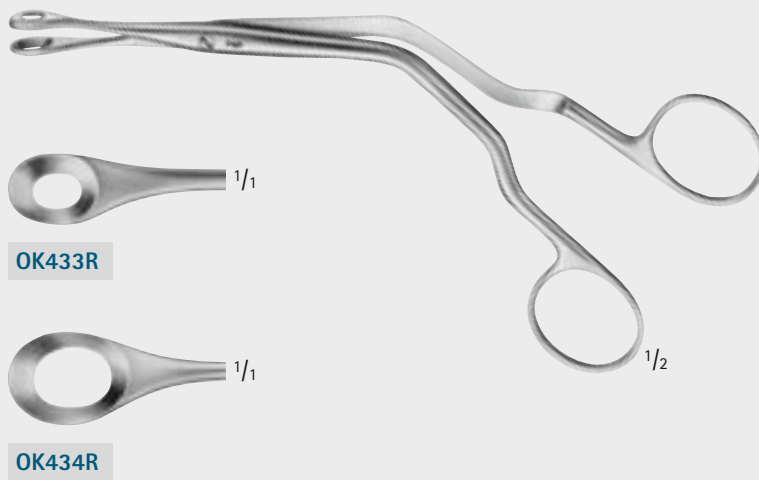

OK433R

OK434R

LUC

OK435R-OK436R

with fenestrated jaws
gefenstert
195 mm, 7 3/4"

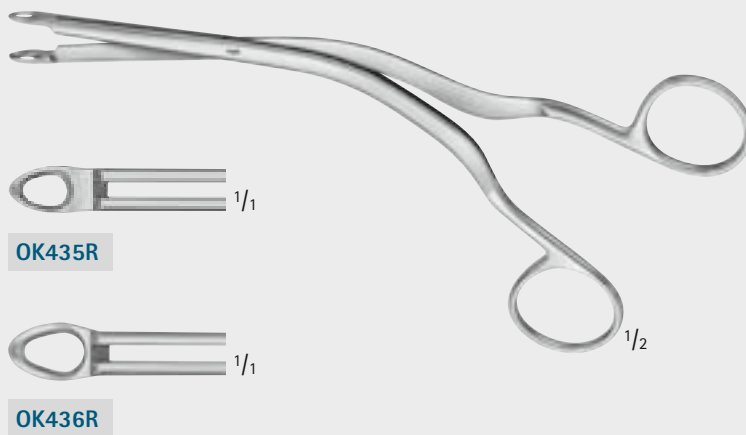

OK435R

OK436R

BRÜNING'S

OK440R-OK443R

190 mm, 7 1/2"

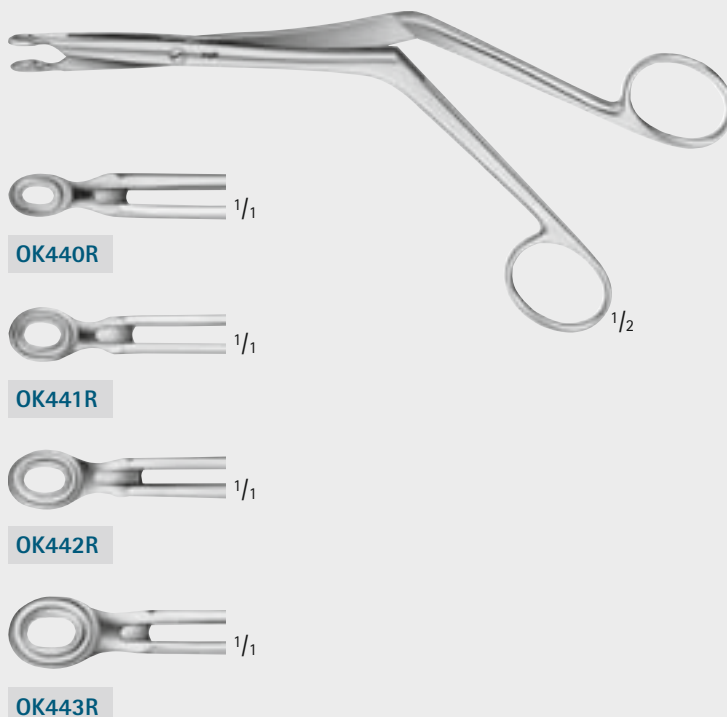

OK440R

OK441R

OK442R

OK443R



Rhinology
Rhinologie

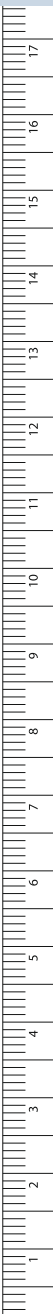

MILLIMETERS

FESS, Rhinology, Rhinoplasty – FESS, Rhinologie, Septum- und Nasenplastik

Rongeurs

Rongeure

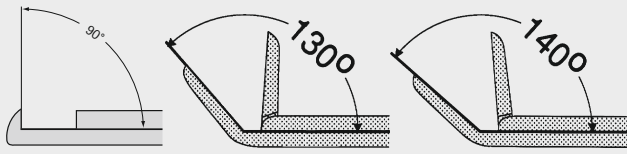

- Angled positions for rongeurs
- Winkelstellungen bei Rongeuren



- Sliding shaft instruments can be disassembled for cleaning and maintenance.
- Bei Schiebenschaft Instrumenten werden Reinigung und Pflege durch Zerlegen ermöglicht.

Rhinology
Rhinologie

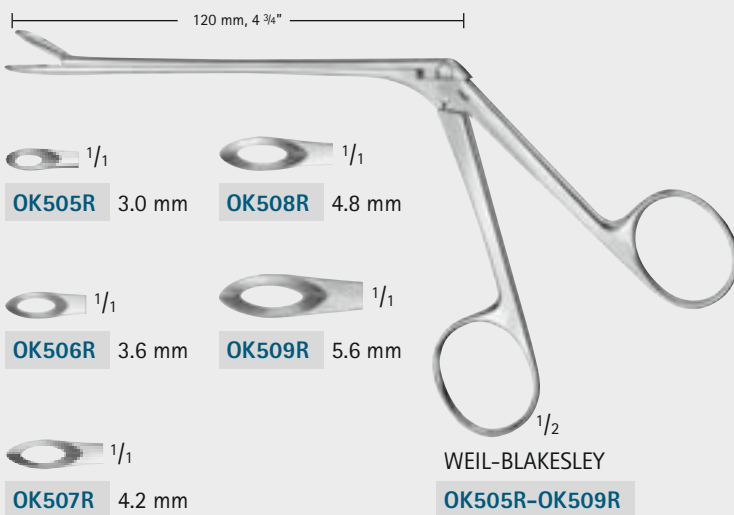

140°
upwards angled
aufwärts gewinkelt

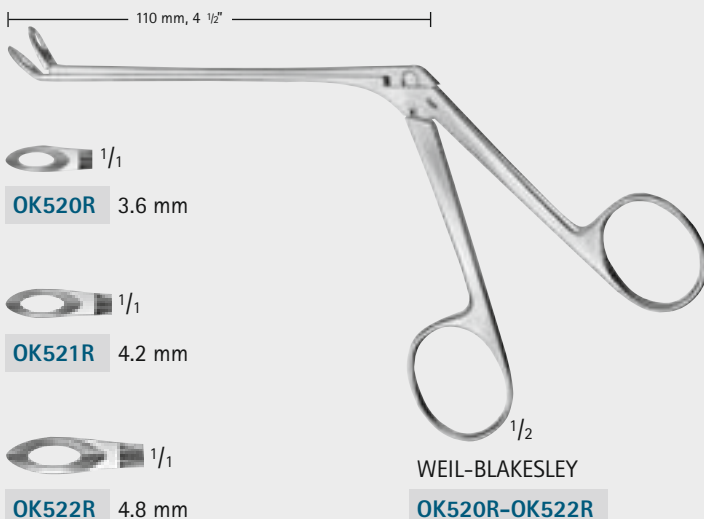

FESS, Rhinology, Rhinoplasty – FESS, Rhinologie, Septum- und Nasenplastik

Rongeurs

Rongeurs

90°
upwards angled
aufwärts gewinkelt

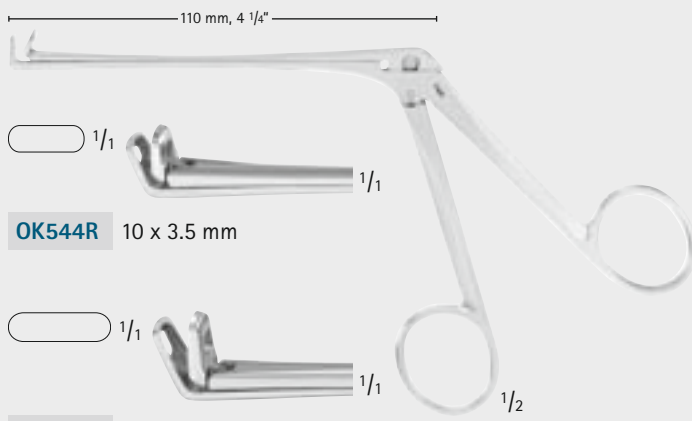

OK544R 10 x 3.5 mm



OK545R 13.5 x 3.8 mm



OK546R 14.3 x 5 mm

BLAKESLEY-WILDE

OK544R-OK546R

90°
upwards angled
aufwärts gewinkelt

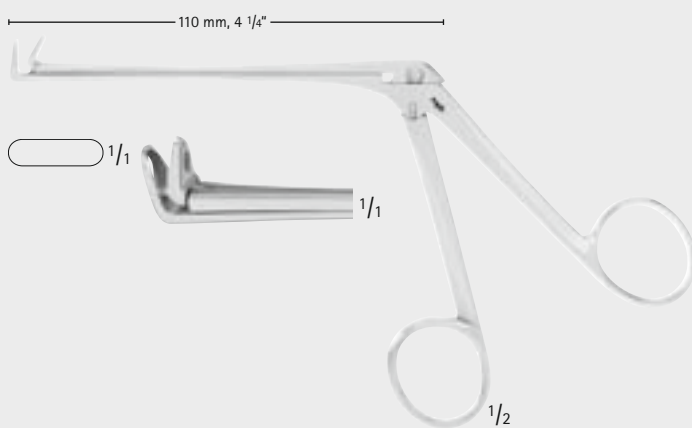

BLAKESLEY-WILDE

OK547R 12.5 x 3.5 mm

90° upwards angled, delicate
90° aufwärts gewinkelt, fein



Rhinology
Rhinologie



MILLIMETERS

FESS, Rhinology, Rhinoplasty – FESS, Rhinologie, Septum- und Nasenplastik

Nasal Forceps, Rongeurs

Nasenzangen, Rongeurs

Rhinology
Rhinologie

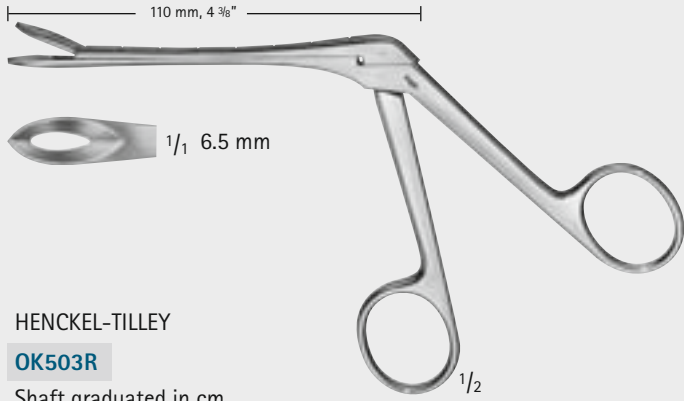

HENCKEL-TILLEY

OK503R

Shaft graduated in cm

Schaft graduiert in cm

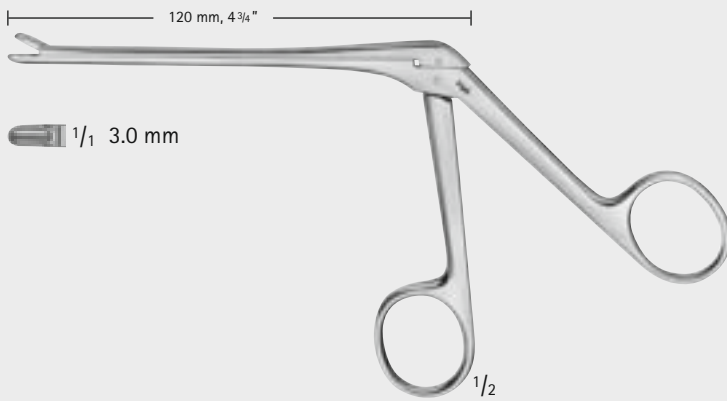

ST. BARTS

OK536R

140°
upwards angled
aufwärts gewinkelt

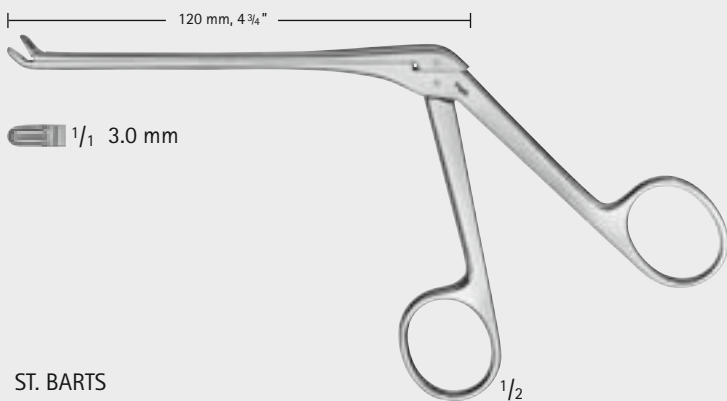

ST. BARTS

OK537R

FESS, Rhinology, Rhinoplasty – FESS, Rhinologie, Septum- und Nasenplastik

Nasal Forceps, Rongeurs

Nasenzangen, Rongeurs

140°
downwards cutting
nach unten schneidend

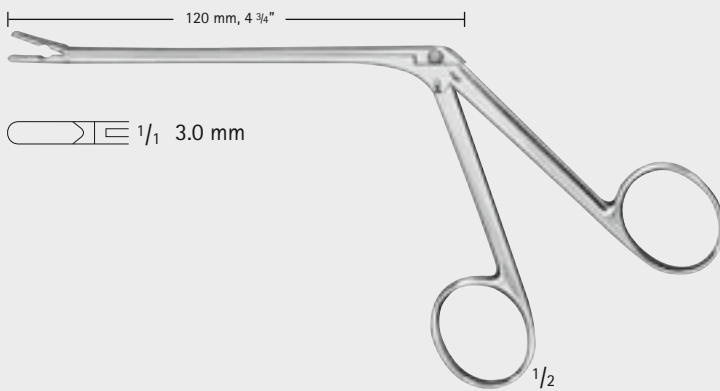
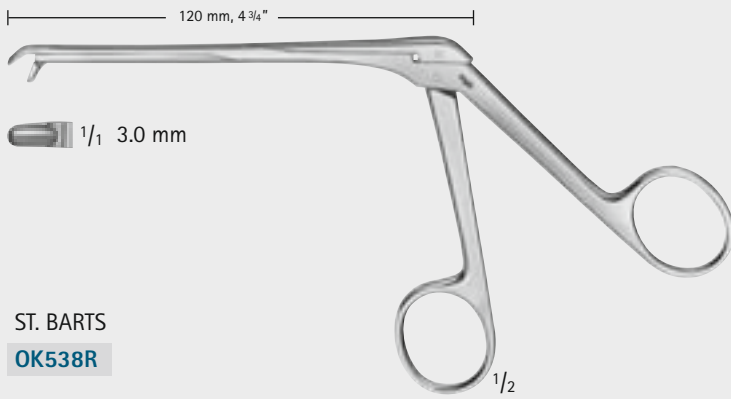

130°
upwards angled
aufwärts gewinkelt

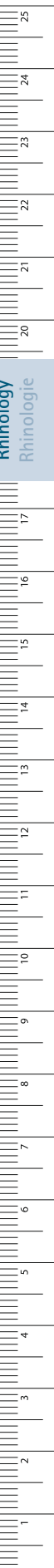
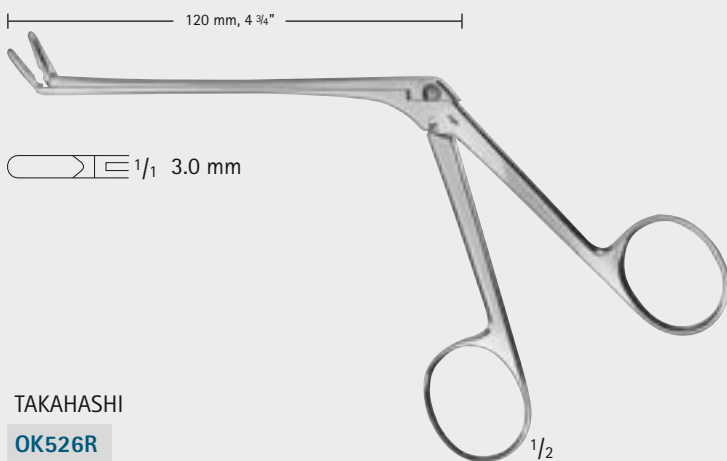

Rhinology
Rhinologie

FESS, Rhinology, Rhinoplasty – FESS, Rhinologie, Septum- und Nasenplastik

Ethmoidal Forceps

Siebbeinzangen, Fasszange

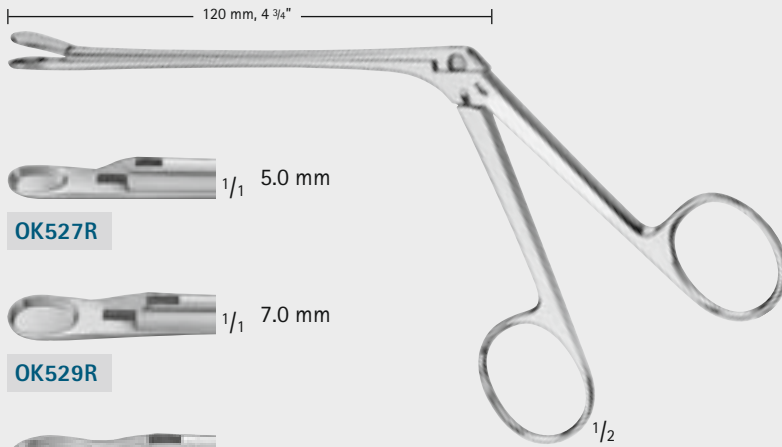

1/1 5.0 mm

OK527R

1/1 7.0 mm

OK529R

1/1 9.0 mm

OK531R

WATSON-WILLIAMS

OK527R-OK531R

Ethmoidal forceps

Siebbeinzange

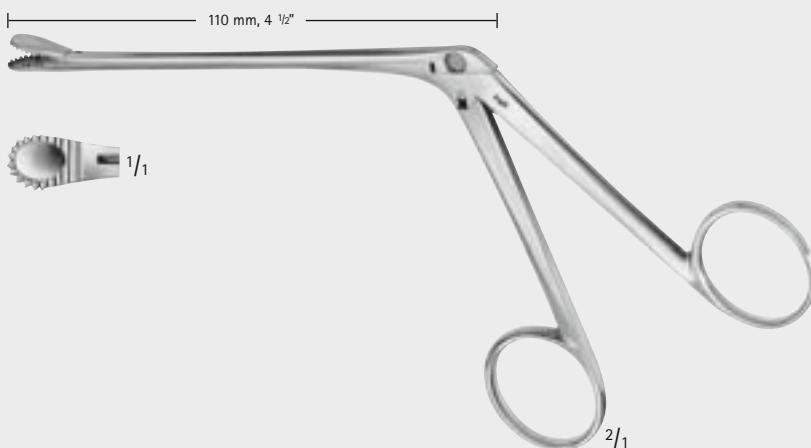

1/1

WATSON-WILLIAMS

OK530R

Ethmoidal forceps for mucosa,
serrated jaws

Fasszange für Schleimhaut,
gezahnt

FESS, Rhinology, Rhinoplasty – FESS, Rhinologie, Septum- und Nasenplastik

Sickle Knife, Antrum Curettes, Frontal Sinus Curettes

Sichelmesser, Antrumlöffel, Stirnhöhlenlöffel



OF601R
Sickle knife, sharp tip
Sichelmesser, spitz
190 mm, 7 1/2"



FK650R
Antrum curette, oval
Antrumlöffel, oval
190 mm, 7 1/2"

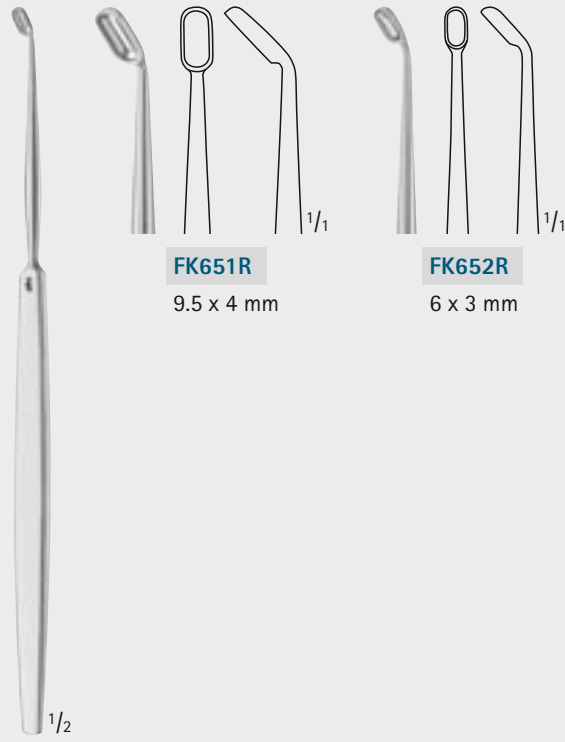

FK651R
9.5 x 4 mm

FK652R
6 x 3 mm

FK651R-FK652R
Antrum curette, oval
Antrumlöffel, oval
190 mm, 7 1/2"

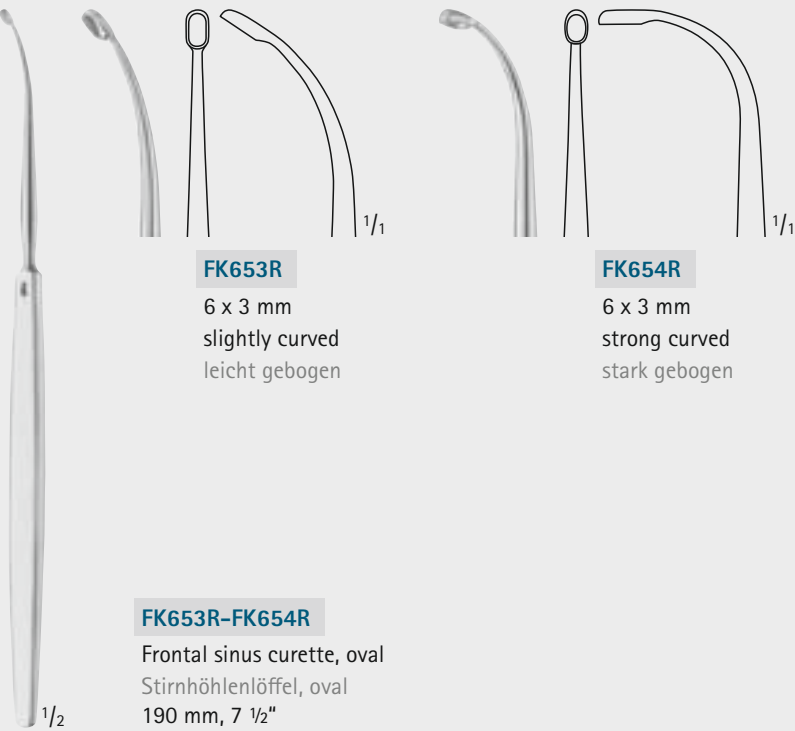

FK653R
6 x 3 mm
slightly curved
leicht gebogen

FK654R
6 x 3 mm
strong curved
stark gebogen

FK653R-FK654R
Frontal sinus curette, oval
Stirnhöhlenlöffel, oval
190 mm, 7 1/2"

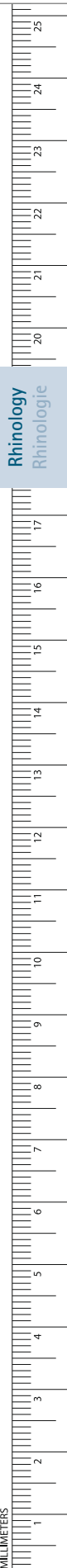

Rhinology
Rhinologie

- Please find further curettes in chapter bone instruments, starting on page 216
- Weitere Löffel und Küretten, siehe Kapitel Knocheninstrumente, ab Seite 216

FESS, Rhinology, Rhinoplasty – FESS, Rhinologie, Septum- und Nasenplastik

Antrum Currettes, Antrum Retractor

Antrumküretten, Antrumahaken



Rhinology
Rhinologie



OK811R OK812R OK813R OK814R OK815R OK816R



COAKLEY
OK811R-OK816R
Antrum currettes
Antrumküretten
170 mm, 6 3/4"



BRÜNINGS-BRUNK
OK800R
Antrum retractor
Antrumahaken
190 mm, 7 1/2"

- Please find further instruments for Neurosurgery in our separate catalog C20102.
- Weitere Instrumente für die Neurochirurgie, siehe Katalog C20101.

FESS, Rhinology, Rhinoplasty – FESS, Rhinologie, Septum- und Nasenplastik

Irrigating Cannulas, Antrum Trocars, Antrum Rasps

Spülröhrchen, Antrumtrokare, Antrumtrephinen



EICKEN

Art. No. Art. Nr.	Diam. (mm) Ø (mm)	Length Länge
OK874C	2.5	130 mm, 5 1/8"
OK875C	3.0	130 mm, 5 1/8"

Irrigating cannula, LUER cone, strong curved, stainless steel
Spülröhrchen, LUER Konus, stark gebogen, rostfreier Stahl



Diam./Ø 2.5 mm

EICKEN

OK876R

Irrigating cannula, LUER cone, slightly curved
Spülröhrchen, LUER Konus, leicht gebogen
145 mm, 5 3/4"



Diam./Ø 2.5 mm

EICKEN

OK877R

Irrigating cannula, LUER cone, shortly curved
Spülröhrchen, LUER Konus, kurz gebogen
145 mm, 5 3/4"



95 mm, 3 3/4"

EJ315R
Diam./Ø 1.7 mm

EJ316R
Diam./Ø 2.0 mm

TILLEY-LICHTWITZ

EJ315R-EJ316R

Antrum trocar
Antrumtrokar
200 mm, 7 7/8"

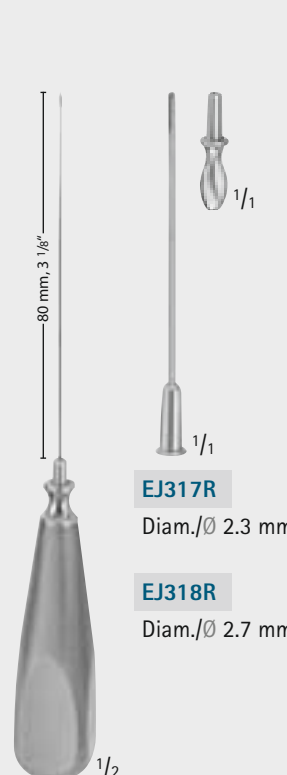

80 mm, 3 1/8"

EJ317R
Diam./Ø 2.3 mm

EJ318R
Diam./Ø 2.7 mm

TILLEY-LICHTWITZ

EJ317R-EJ318R

Antrum trocar
Antrumtrokar
185 mm, 7 1/4"



OK804R
sharp
scharf

OK805R
blunt
stumpf

OK804R-OK805R

Antrum rasps, American pattern
Antrumtrephine, amerikanisches Modell
180 mm, 7"

FESS, Rhinology, Rhinoplasty – FESS, Rhinologie, Septum- und Nasenplastik

Frontal Sinus Ostium Seeker, Trocars, Irrigating Cannula

Stirnhöhle-Doppelinstrument, Trokare, Spülkanüle

Rhinology
Rhinologie

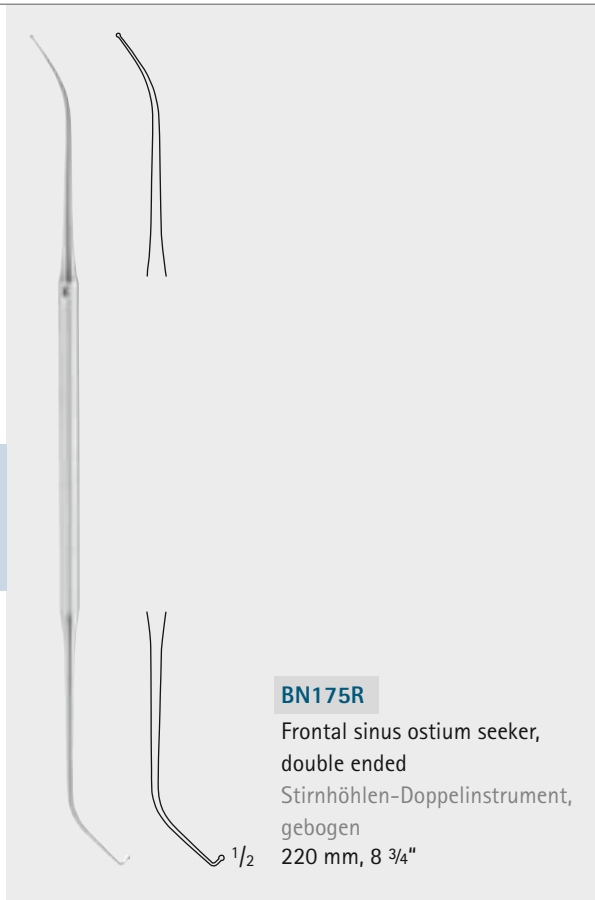

BN175R

Frontal sinus ostium seeker,
double ended
Stirnhöhlen-Doppelinstrument,
gebogen
220 mm, 8 3/4"

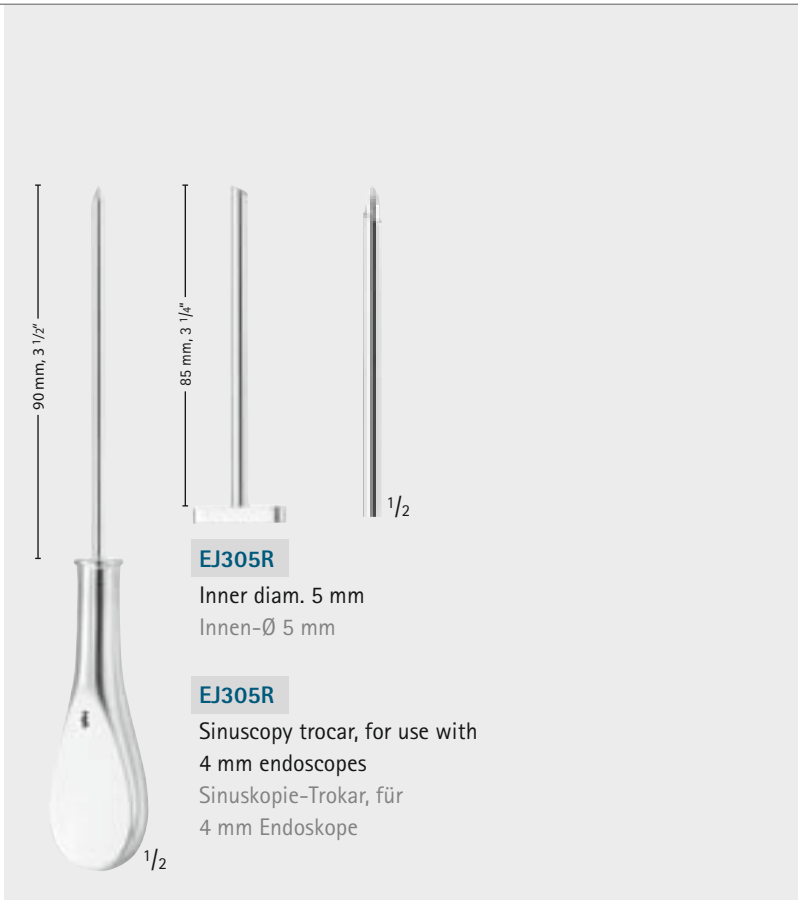

EJ305R

Inner diam. 5 mm
Innen-Ø 5 mm

EJ305R

Sinuscopy trocar, for use with
4 mm endoscopes
Sinuskopie-Trokar, für
4 mm Endoskope

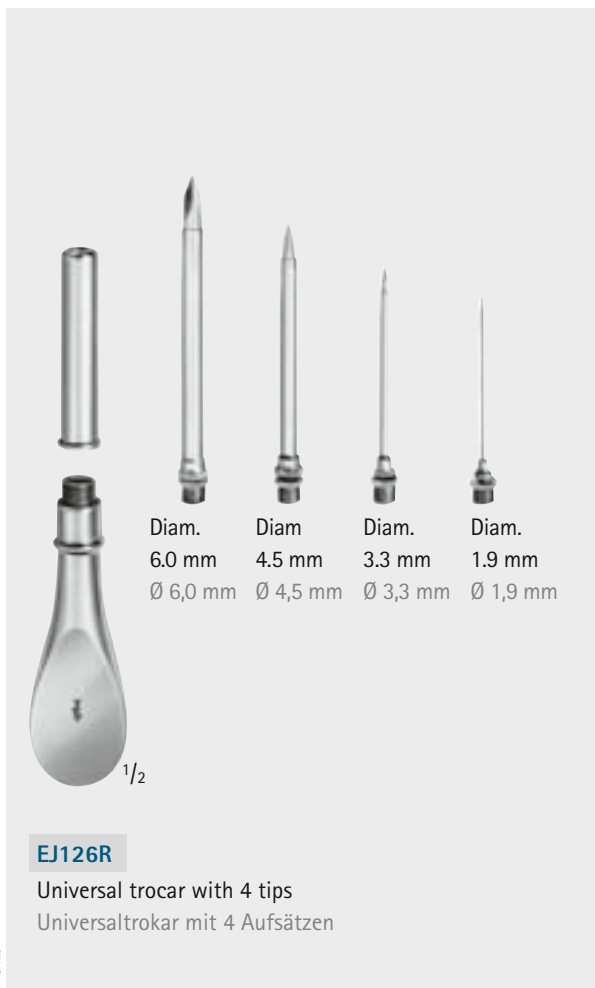

EJ126R

Universal trocar with 4 tips
Universaltrokar mit 4 Aufsätzen

Diam.	Diam.	Diam.	Diam.
6.0 mm	4.5 mm	3.3 mm	1.9 mm
Ø 6,0 mm	Ø 4,5 mm	Ø 3,3 mm	Ø 1,9 mm

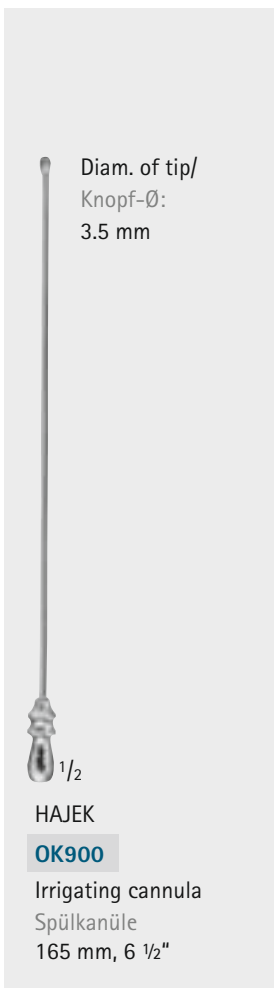

Diam. of tip/
Knopf-Ø:
3.5 mm

HAJEK

OK900

Irrigating cannula
Spülkanüle
165 mm, 6 1/2"

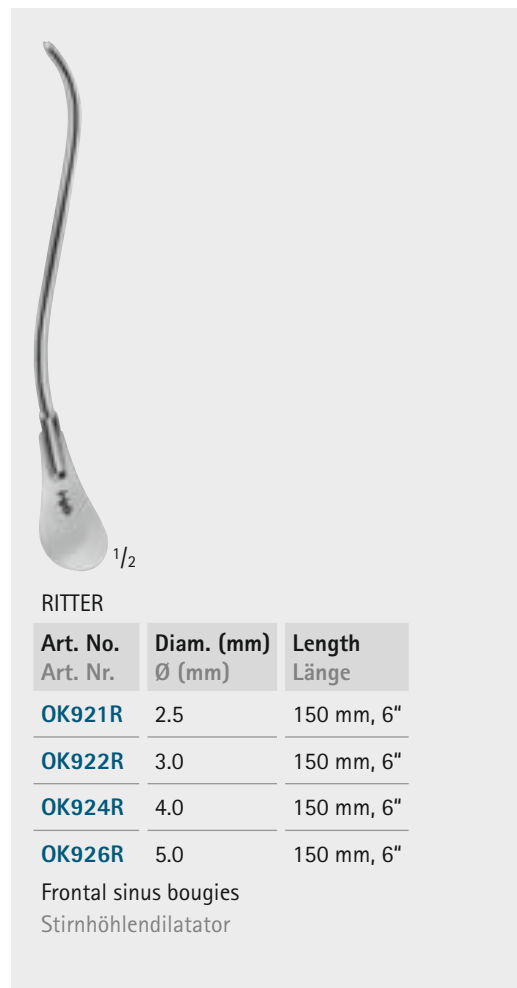

RITTER

Art. No. Art. Nr.	Diam. (mm) Ø (mm)	Length Länge
OK921R	2.5	150 mm, 6"
OK922R	3.0	150 mm, 6"
OK924R	4.0	150 mm, 6"
OK926R	5.0	150 mm, 6"

Frontal sinus bougies
Stirnhöhlelilatator

FESS, Rhinology, Rhinoplasty – FESS, Rhinologie, Septum- und Nasenplastik

Hypophysectomy Specula

Hypophysektomie Spekula



CUSHING-LANDOLT

Art. No.	Blade size (mm)
Art. Nr.	Blattgröße (mm)

OK100R	70 x 15
--------	---------

OK101R	90 x 15
--------	---------

OK102R	110 x 15
--------	----------

Specula for transsphenoidale hypophysectomy

Spekula für transsphenoidale Hypophysektomie



LANDOLT

OK103R

Spreader, for spreading of specula

OK100R, OK101R, OK102R

Spreizzange, zum Spreizen der Spekulas

OK100R, OK101R, OK102R

210 mm, 8 1/4"

FESS, Rhinology, Rhinoplasty – FESS, Rhinologie, Septum- und Nasenplastik

Hypophysectomy Specula

Hypophysektomie Spekula

Rhinology
Rhinologie

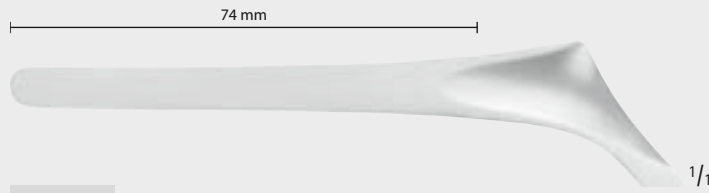

OK090R

Fig. 5

Selfretaining septum speculum suitable as introducer for FF590R, FF591R

Septum specula, aseptic joint. Set-screw, with extra thin blades

Selbshaltendes Septumspekulum, geeignet als Einführhilfe für FF590R, FF591R

Nasenspekula, mit Steckschluss und Stellschraube, mit besonders schlanken Blättern



COTTLE

OK090R-OK108R

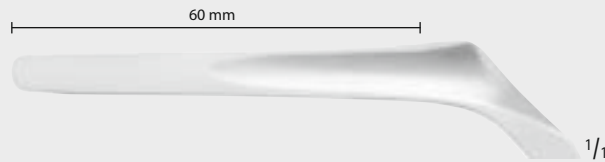

OK108R

Fig. 4

Selfretaining septum speculum suitable as introducer for FF589R

Nasal specula with aseptic joint and set-screw

Selbshaltendes Septumspekulum, geeignet als Einführungshilfe für FF589R

Nasenspekula mit Steckschluss und Stellschraube



PAPAVERO-CASPAR

Art. No.	Blade size (mm)
Art. Nr.	Blattgröße (mm)
FF589R	80 x 11
FF590R	90 x 13
FF591R	100 x 15

Slim profile and lightweight specula for Transsphenoidal surgery with key TE749R
Schlanke und leichte Spekula für die Transsphenoidaloperation inkl. TE749R
Spannschlüssel

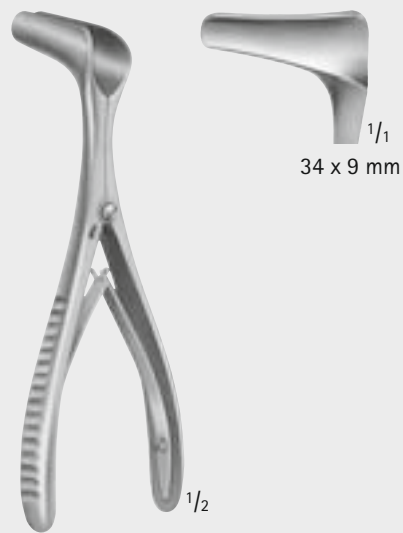

PAPAVERO-HARTMANN

FF595R

Spreader for specula FF589R, FF590R, FF591R

Spreizer für Spekula FF589R, FF590R, FF591R

140 mm, 5 1/2"

FESS, Rhinology, Rhinoplasty – FESS, Rhinologie, Septum- und Nasenplastik

Micro Scissors and -Forceps

Mikro-Scheren und -Zangen

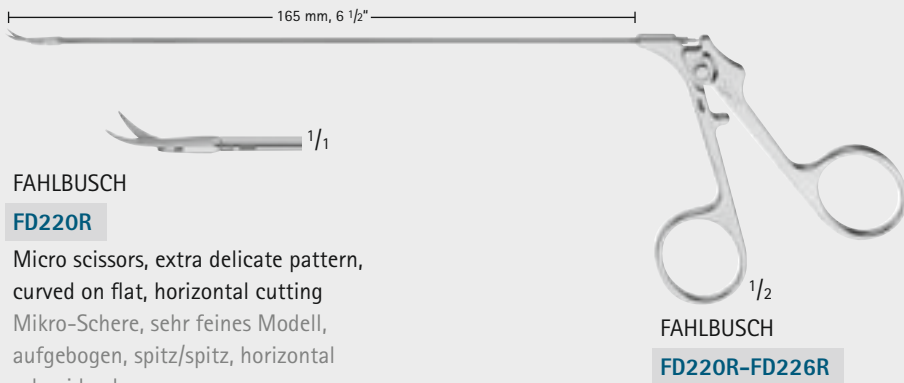

FAHLBUSCH

FD220R

Micro scissors, extra delicate pattern, curved on flat, horizontal cutting
Mikro-Schere, sehr feines Modell, aufgebogen, spitz/spitz, horizontal schneidend

FAHLBUSCH

FD220R-FD226R



NICOLA

FD222R

Forceps, scoop-shaped, diam. 2.5 mm
Scharfe Zange mit löffelförmigen Maul, Ø 2,5 mm



YASARGIL-NICOLA

FD224R

Grasping forceps with long conical jaw
Fasszange mit feinem Maul



NICOLA

FD226R

Micro scissors, straight, diam 2.5 mm
Mikro-Schere, gerade, Ø 2,5 mm

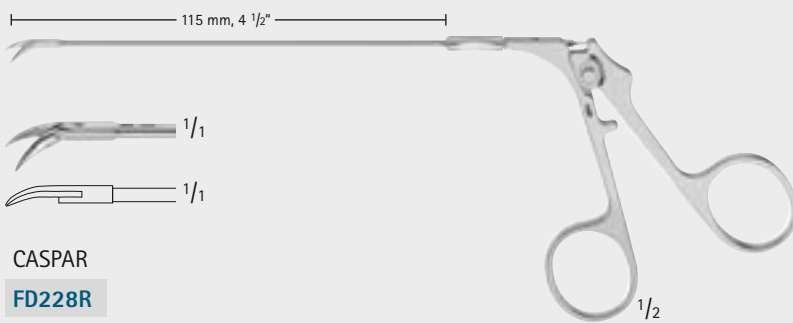

CASPAR

FD228R

Micro scissors, curved, rotatable 360°
Mikro-Schere, gebogen, 360° drehbar

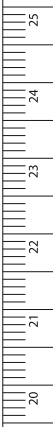

Rhinology
Rhinologie

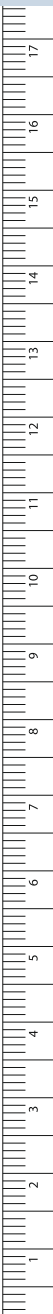

MILLIMETERS

FESS, Rhinology, Rhinoplasty – FESS, Rhinologie, Septum- und Nasenplastik

Micro-Scissors, Mikro-Forceps

Mikro-Scherchen, Micro-Fasszängchen

180 mm, 7"

1/2

FA072R
straight
gerade

FA073R
left curved
links gebogen

FA074R
right curved
rechts gebogen

FA075R
angular
gewinkelt

FA072R-FA075R
Micro scissors
Mikro-Scherchen

Rhinology
Rhinologie

180 mm, 7"

1/2

FA069R
straight
gerade

FA070R
right curved
rechts gebogen

FA071R
left curved
links gebogen

FA069R-FA071R
Micro forceps
Mikro-Fasszängchen

INCHES

FESS, Rhinology, Rhinoplasty – FESS, Rhinologie, Septum- und Nasenplastik

Rongeurs, Tumor Grasping Forceps

Rongeurs, Tumorfasszange

180 mm, 7"

1/1 Diam. / Ø 7.0 mm

OLDBERG
FF605R
 Rongeur
 Rongeur

1/2

190 mm, 7 1/2"

1/1 Diam. / Ø 2.2 mm

FF599R

1/1 Diam. / Ø 3.5 mm

FF600R

YASARGIL
FF599R-FF600R
 Rongeur
 Rongeur

1/2

205 mm, 8"

1/1

1/1 Diam. / Ø 9.0 mm

LANDOLT
FF345R
 Tumor grasping forceps, blunt
 Tumorfasszange, stumpf

1/2

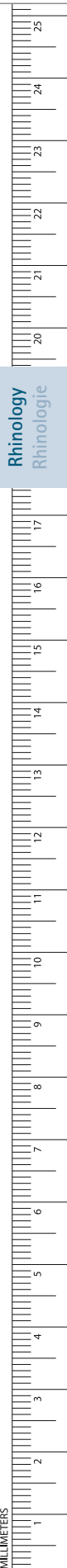

Rhinology
Rhinologie

MILLIMETERS

- Please find bone punches in chapter bone instruments, starting on page 255
- Knochenstanzen siehe Kapitel Knocheninstrumente, ab Seite 255

FESS, Rhinology, Rhinoplasty – FESS, Rhinologie, Septum- und Nasenplastik

Curettes, Enucleators

Küretten, Enukleatoren

Rhinology
Rhinologie



NICOLA ^{1/1}

FA041R

Curette, diam. 6.5 mm,
45° vertical angled,
long neck
Kürette, Ø 6,5 mm,
45° vertikal gewinkelt,
langer Hals



NICOLA ^{1/1}

FA042R

Curette, diam. 6.5 mm,
45° horizontal angled,
short neck
Kürette, Ø 6,5 mm,
45° horizontal gewinkelt,
kurzer Hals



HARDY ^{1/1}

FA043R

Enucleator,
left cutting
Enukleator,
links schneidend



HARDY ^{1/1}

FA044R

Enucleator,
right cutting
Enukleator,
rechts schneidend



HARDY ^{1/1}

FA045R

Curette, diam. 4.0 mm,
90° left angled,
long neck
Kürette, Ø 4,0 mm,
90° nach links gewinkelt,
langer Hals



HARDY ^{1/1}

FA046R

Curette, diam. 4.0 mm,
90° left angled,
short neck
Kürette, Ø 4,0 mm,
90° nach links gewinkelt,
kurzer Hals



HARDY ^{1/1}

FA047R

Curette, diam. 4.0 mm,
90° right angled,
long neck
Kürette, Ø 4,0 mm,
90° nach rechts
gewinkelt,
langer Hals



HARDY ^{1/1}

FA060R

Curette, diam. 4.0 mm,
90° right angled,
short neck
Kürette, Ø 4,0 mm,
90° nach rechts
gewinkelt,
kurzer Hals

FA041R-FA068R

Working length: 130 mm, 5 1/8"

Total length: 280 mm, 11"

Arbeitslänge: 130 mm, 5 1/8"

Gesamtlänge: 280 mm, 11"

FESS, Rhinology, Rhinoplasty – FESS, Rhinologie, Septum- und Nasenplastik

Curettes, Micro-Hook, Dissector
Küretten, Mikro-Häkchen, Dissektor

HARDY

FA061R

Curette, diam. 4.0 mm,
45° horizontal left
angled, short neck
Kürette, Ø 4,0 mm,
45° horizontal
nach links gewinkelt,
kurzer Hals



HARDY

FA062R

Curette, diam. 4.0 mm,
45° horizontal right
angled, short neck
Kürette, Ø 4,0 mm,
45° horizontal nach
rechts gewinkelt,
kurzer Hals



HARDY

FA063R

Curette, diam. 6.0 mm,
90° left angled,
long neck
Kürette, Ø 6,0 mm,
90° nach links gewinkelt,
langer Hals



HARDY

FA064R

Curette, diam. 6.0 mm,
90° left angled,
short neck
Kürette, Ø 6,0 mm,
90° nach links gewinkelt,
kurzer Hals



HARDY

FA065R

Curette, diam. 6.0 mm,
90° right angled,
long neck
Kürette, Ø 6,0 mm,
90° nach rechts gewinkelt,
langer Hals



HARDY

FA066R

Curette, diam. 6.0 mm,
90° right angled,
short neck
Kürette, Ø 6,0 mm,
90° nach rechts
gewinkelt,
kurzer Hals



LANDOLT-REULEN

FA067R

Micro hook,
diam. 1.7 mm
Mikro-Häkchen,
Ø 1,7 mm



LANDOLT-REULEN

FA068R

Dissector,
diam. 2.0 mm,
blunt
Dissektor,
Ø 2,0 mm,
stumpf

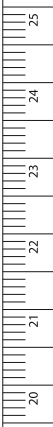
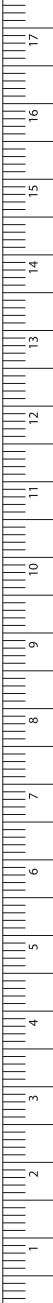
Rhinology
Rhinologie

MILLIMETERS

FESS, Rhinology, Rhinoplasty – FESS, Rhinologie, Septum- und Nasenplastik

Curettes, Enucleators, Micro-Hook, Dissector

Küretten, Enukleatoren, Mikro-Häkchen, Dissektor

Rhinology
Rhinologie

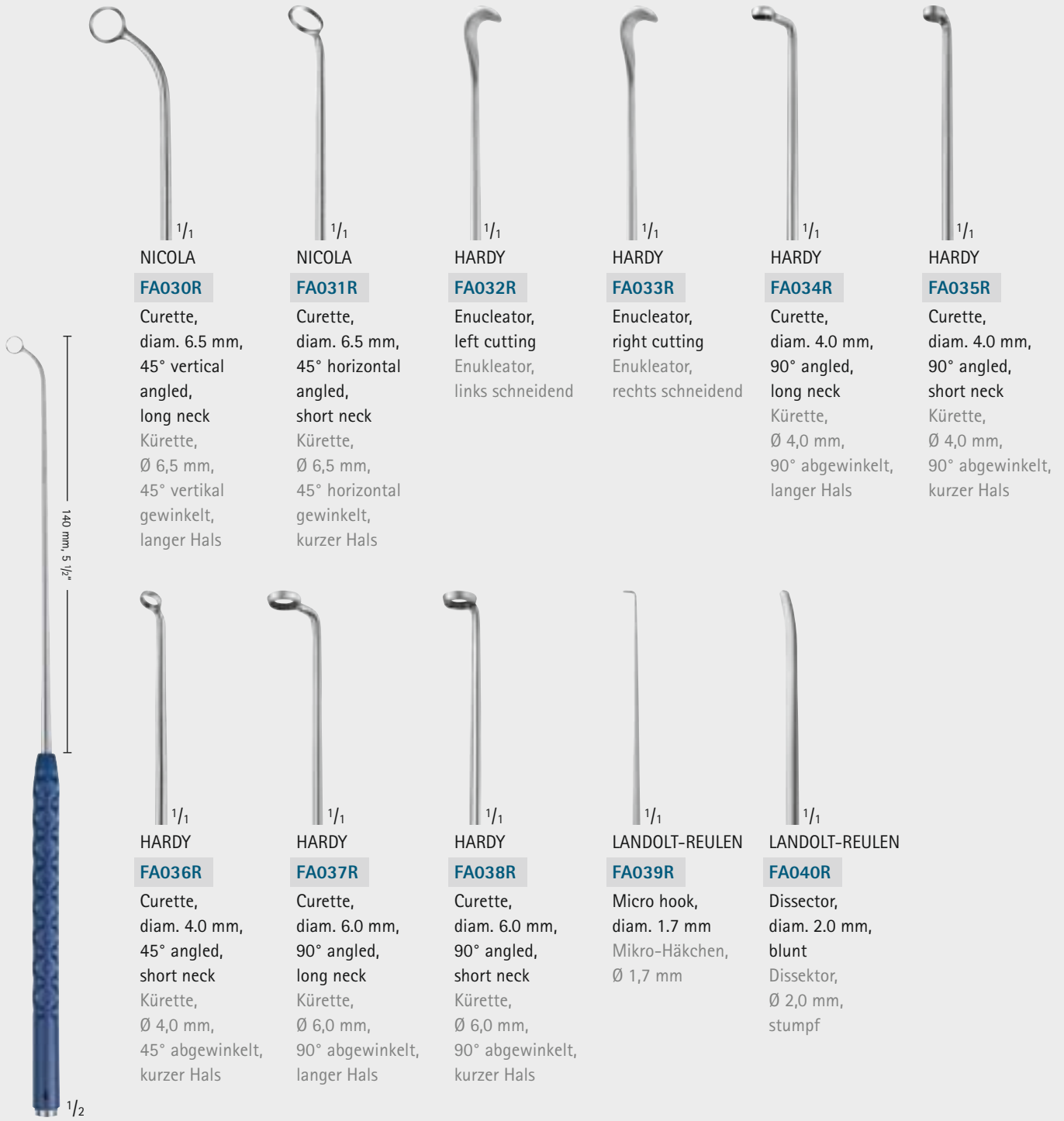

NICOLA
FA030R

Curette,
diam. 6.5 mm,
45° vertical
angled,
long neck
Kürette,
Ø 6,5 mm,
45° vertikal
gewinkelt,
langer Hals

NICOLA
FA031R

Curette,
diam. 6.5 mm,
45° horizontal
angled,
short neck
Kürette,
Ø 6,5 mm,
45° horizontal
gewinkelt,
kurzer Hals

HARDY
FA032R

Enucleator,
left cutting
Enukleator,
links schneidend

HARDY
FA033R

Enucleator,
right cutting
Enukleator,
rechts schneidend

HARDY
FA034R

Curette,
diam. 4.0 mm,
90° angled,
long neck
Kürette,
Ø 4,0 mm,
90° abgewinkelt,
langer Hals

HARDY
FA035R

Curette,
diam. 4.0 mm,
90° angled,
short neck
Kürette,
Ø 4,0 mm,
90° abgewinkelt,
kurzer Hals

HARDY
FA036R

Curette,
diam. 4.0 mm,
45° angled,
short neck
Kürette,
Ø 4,0 mm,
45° abgewinkelt,
kurzer Hals

HARDY
FA037R

Curette,
diam. 6.0 mm,
90° angled,
long neck
Kürette,
Ø 6,0 mm,
90° abgewinkelt,
langer Hals

HARDY
FA038R

Curette,
diam. 6.0 mm,
90° angled,
short neck
Kürette,
Ø 6,0 mm,
90° abgewinkelt,
kurzer Hals

LANDOLT-REULEN
FA039R

Micro hook,
diam. 1.7 mm
Mikro-Häkchen,
Ø 1,7 mm

LANDOLT-REULEN
FA040R

Dissector,
diam. 2.0 mm,
blunt
Dissektor,
Ø 2,0 mm,
stumpf

FA030R-FA040R

Working length: 140 mm, 5 1/2"
Total length: 265 mm, 10 1/2"
Straight design: with ergonomic
grasping part and semi-sharp tips
Arbeitslänge: 140 mm, 5 1/2"
Gesamtlänge: 265 mm, 10 1/2"
Schaftdesign: gerade, mit
ergonomischem Handgriff und
halbscharfen Arbeitsenden

MINOP® TREND

TRansnasal ENDoscopic System



For further informations, please see our Operating Manual and product overview in the separat brochure C26402.

Weitere Informationen über OP-Anleitung und Produktübersicht MINOP®, siehe Prospekt C26401.

For further informations, please see our Endoscopy Units and Accessories brochure C46702.

Weitere Informationen über Geräte und Optiken, siehe Prospekt C46701.

FESS, Rhinology, Rhinoplasty - FESS, Rhinologie, Septum- und Nasenplastik

Nasal Scissors

Nasenscheren



Rhinology
Rhinologie

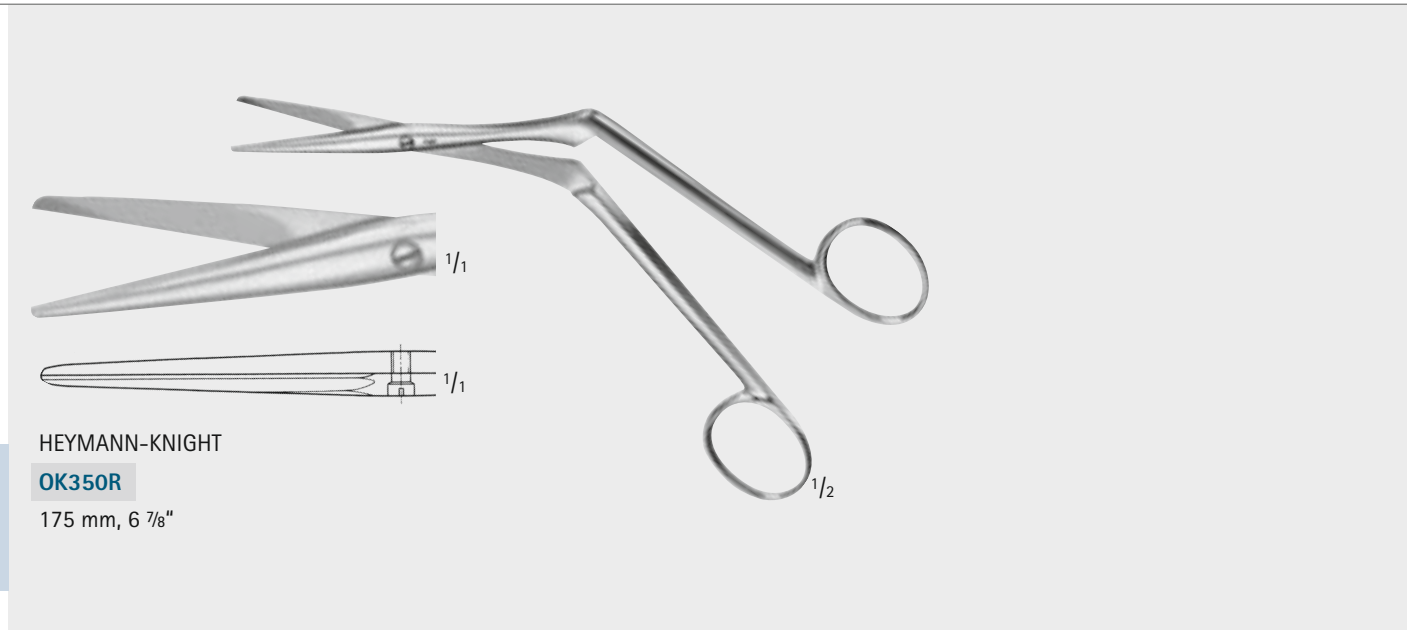

HEYMANN-KNIGHT

OK350R

175 mm, 6 7/8"

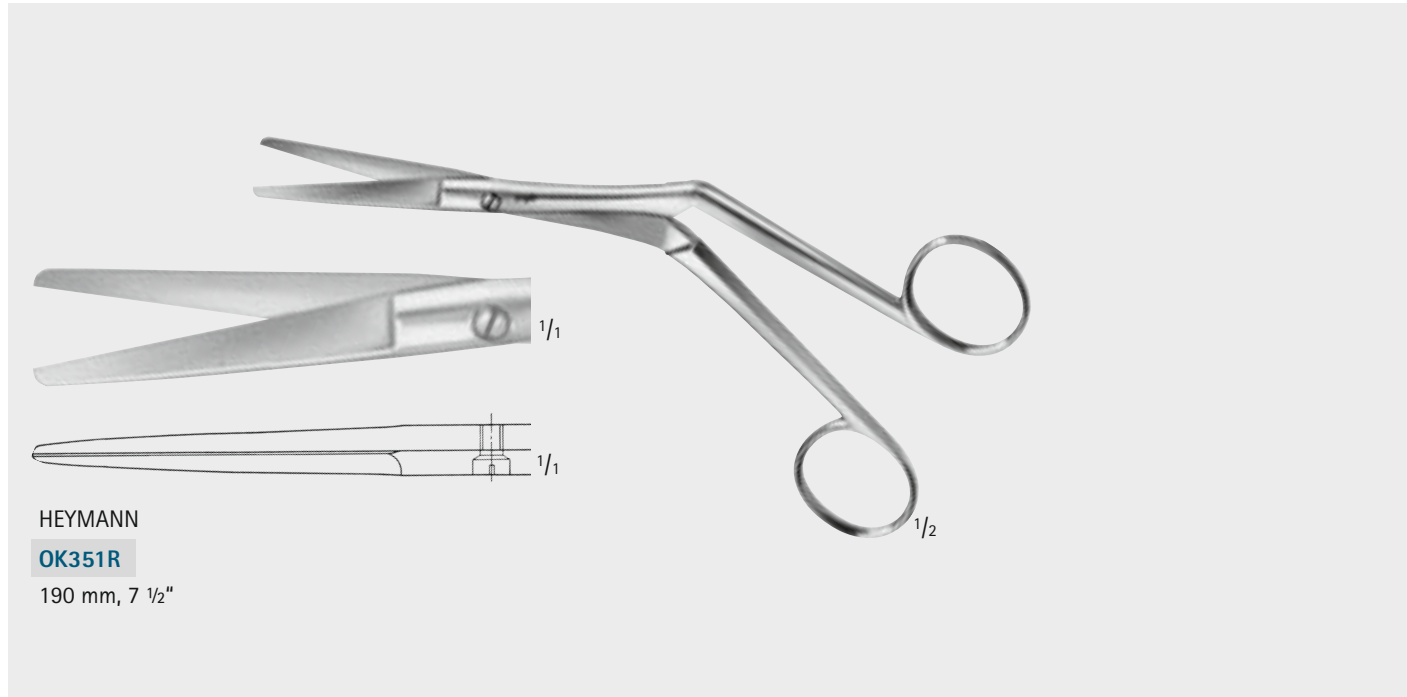

HEYMANN

OK351R

190 mm, 7 1/2"

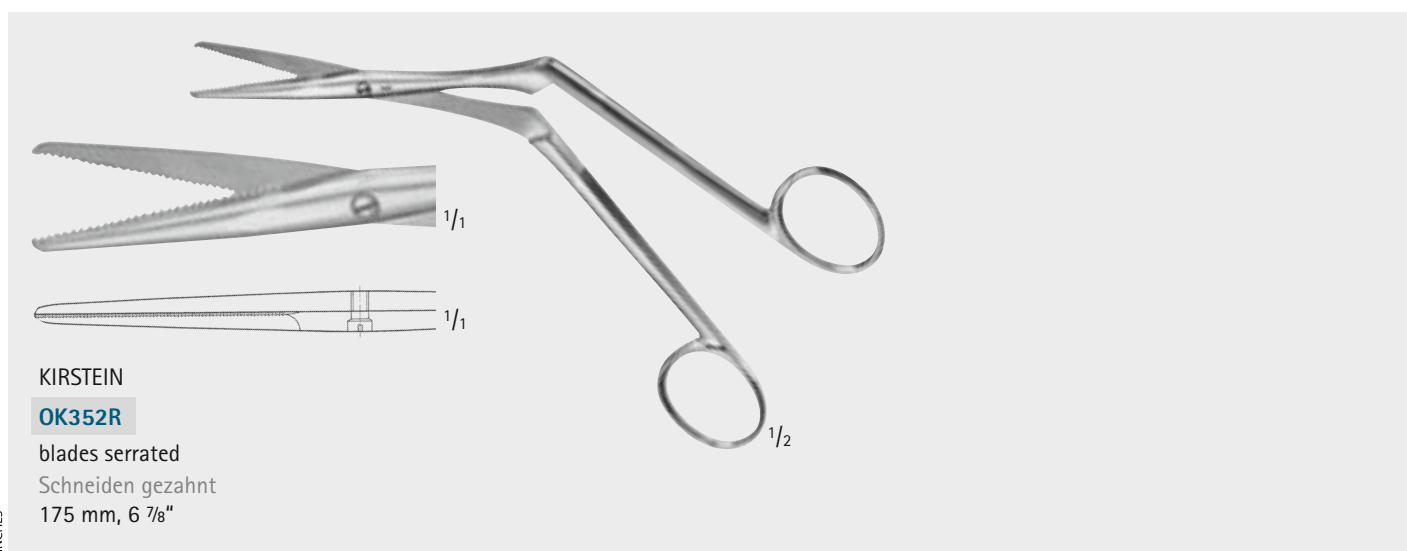

KIRSTEIN

OK352R

blades serrated

Schneiden gezahnt

175 mm, 6 7/8"

FESS, Rhinology, Rhinoplasty – FESS, Rhinologie, Septum- und Nasenplastik

Nasal Scissors, Septum Scissors

Nasenscheren, Septumschere

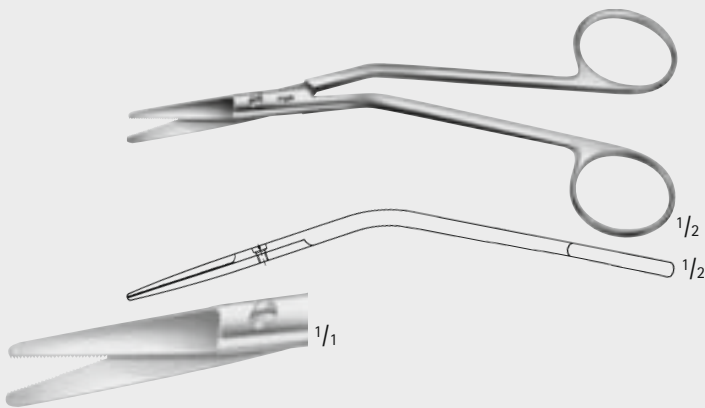

FOMON

OK370R

Nasal scissors, straight, serrated blades, angled handle, blunt/blunt
 Nasenschere, beide Schneiden gezahnt, kniegebogen, stumpf/stumpf
 145 mm, 5 3/4"

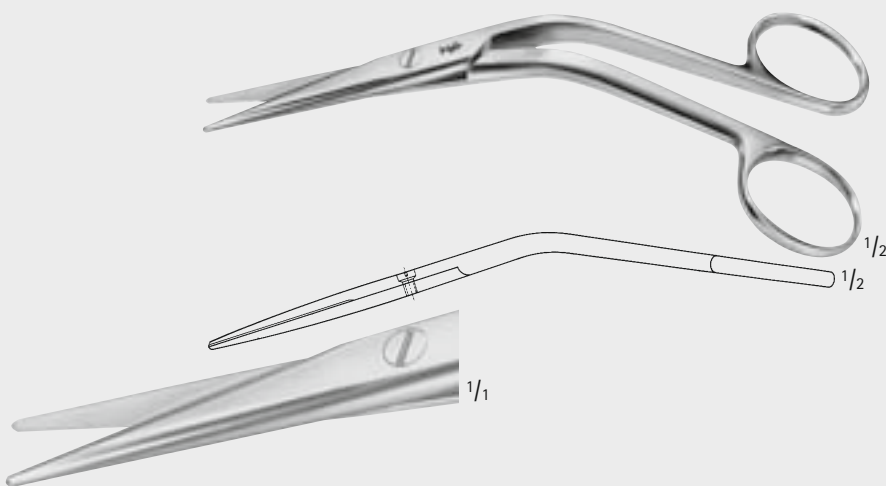

COTTLE

OK371R

Nasal scissors, straight blades, angled handle, blunt/blunt
 Nasenschere, kniegebogen, stumpf/stumpf
 165 mm, 6 1/2"

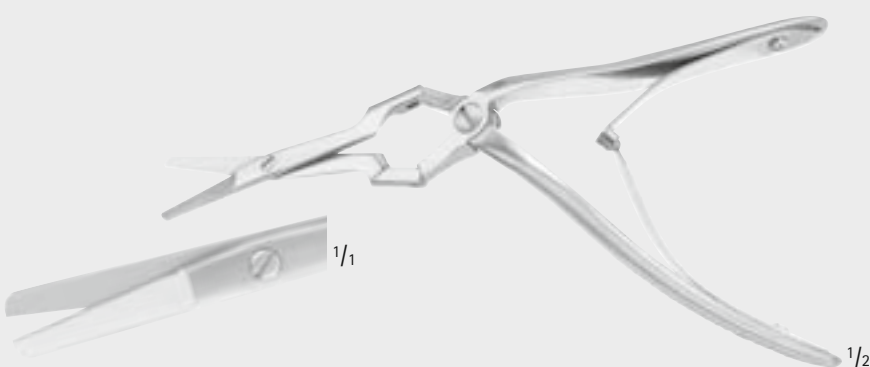
**OK353R**

Septum scissors with double joint, blades serrated
 Septumschere mit Doppelgelenk, Schneiden gezahnt
 180 mm, 7"

FESS, Rhinology, Rhinoplasty – FESS, Rhinologie, Septum- und Nasenplastik

Nasal Dressing Forceps

Nasentamponzangen



Rhinology
Rhinologie

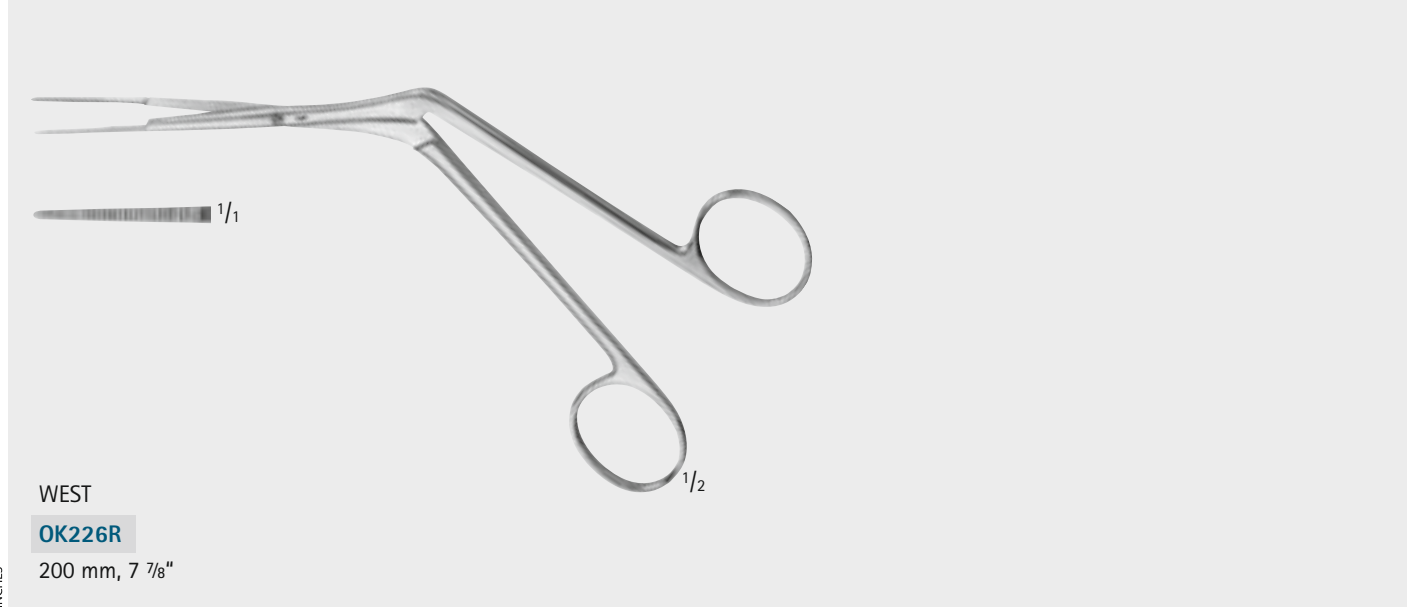
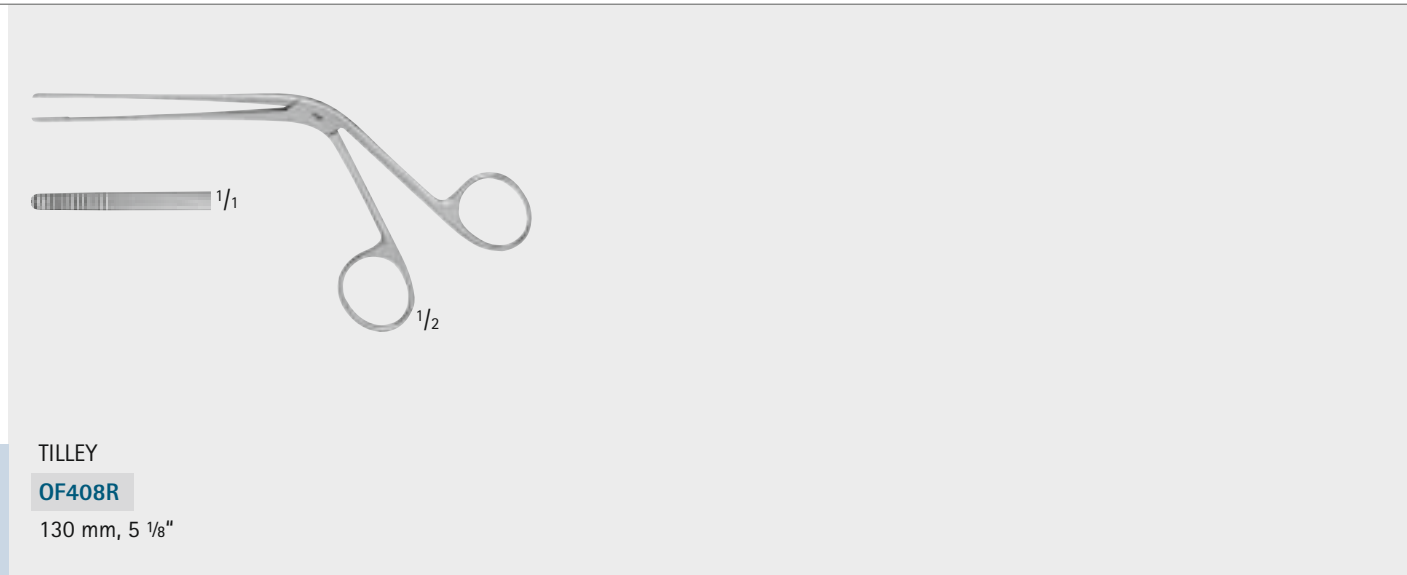

FESS, Rhinology, Rhinoplasty – FESS, Rhinologie, Septum- und Nasenplastik

Nasal Dressing Forceps

Nasentamponzangen

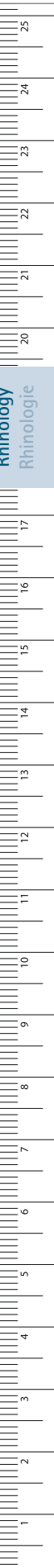
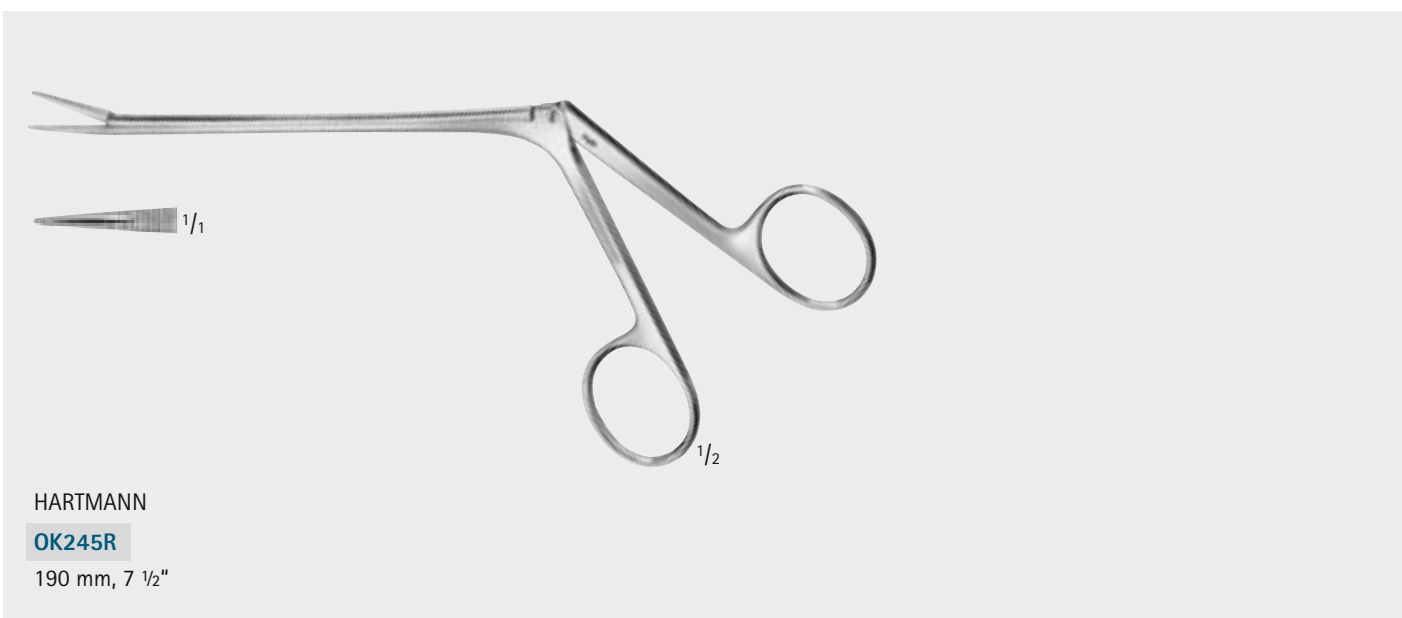
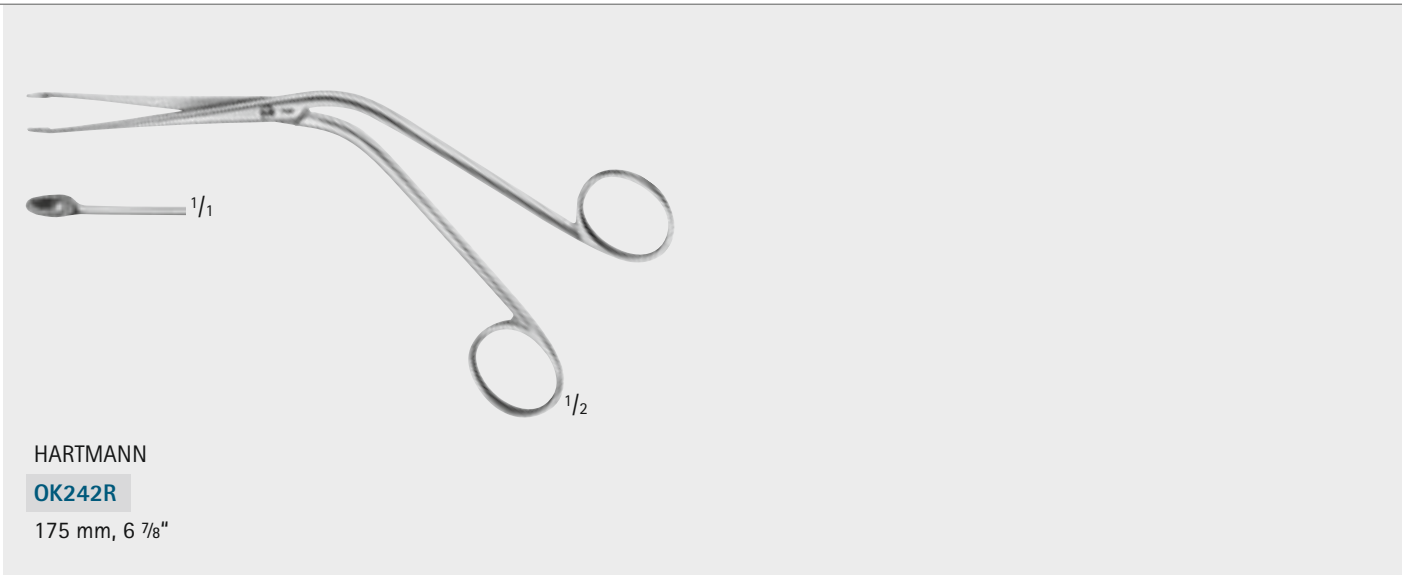

Rhinology
Rhinologie

FESS, Rhinology, Rhinoplasty – FESS, Rhinologie, Septum- und Nasenplastik

Nasal Forceps

Nasenzangen

Rhinology
Rhinologie

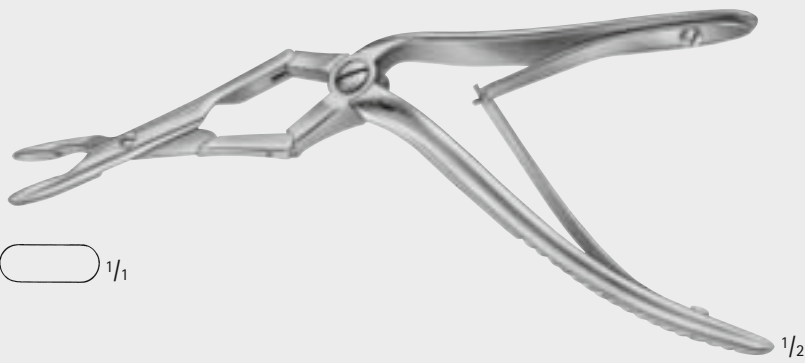

JANSEN-MIDDLETON

OK400R

spoon-shaped, biting
aufeinanderschneidend
200 mm, 7 7/8"

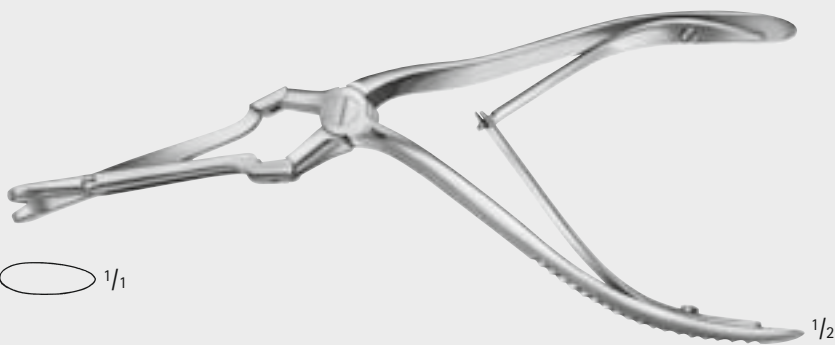

JANSEN-MIDDLETON

OK405R

through cutting
durchschneidend
210 mm, 8 1/4"

FESS, Rhinology, Rhinoplasty – FESS, Rhinologie, Septum- und Nasenplastik

Septum Forceps

Septumzangen

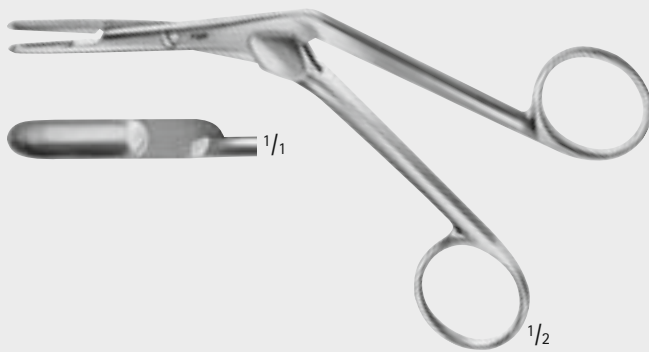

CRAIG

OK410R

Septum bone cutting and breaking forceps, straight, sharp spoons

Vomerzange, gerade, scharfe Löffel

165 mm, 6 1/2"

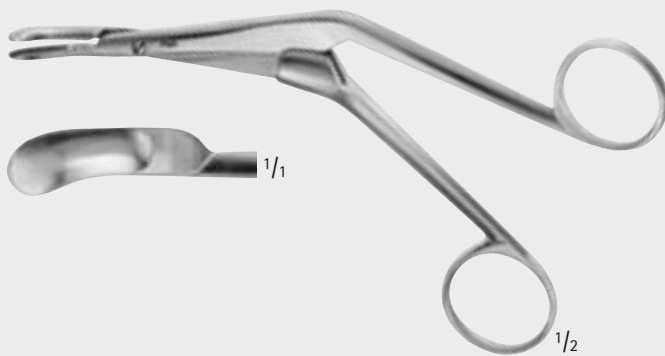

CRAIG-DOMNICK

OK412R

Septum bone cutting and breaking forceps, curved to the left, sharp spoons

Vomerzange, linksgebogen, scharfe Löffel

165 mm, 6 1/2"

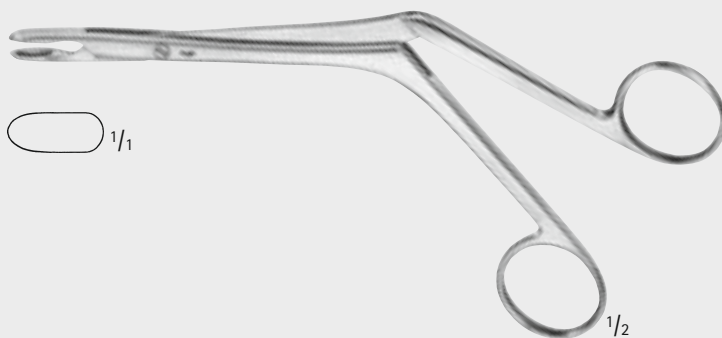

HEYMANN-KNIGHT

OK422R

Septum forceps, with sharp oval spoons

Septumzange, mit scharfen, ovalen Löffeln

190 mm, 7 1/2"

FESS, Rhinology, Rhinoplasty – FESS, Rhinologie, Septum- und Nasenplastik

Nasal Mirror, Mucous Knife, Swivel Knife

Nasenspiegel, Mukosamesser, Schwingmesser

Rhinology
Rhinologie

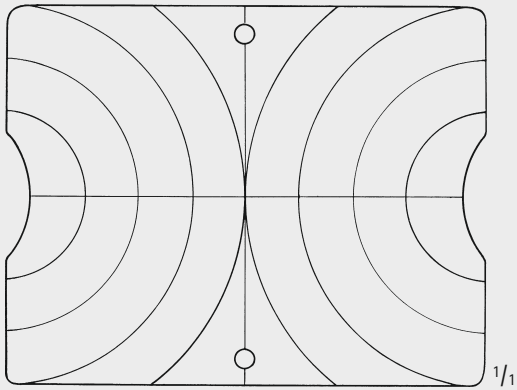

GLATZEL

OK001

Nasal mirror

Nasenspiegel

200 x 130 mm, 7 7/8 x 5 1/8"



CASTROVIEJO

OB792R

Caliper,

measuring range 0-15 mm

Messzirkel,

Messbereich 0-15 mm

75 mm, 3"



FREER

OL120R

Mucous knife

Mukosamesser

150 mm, 6"

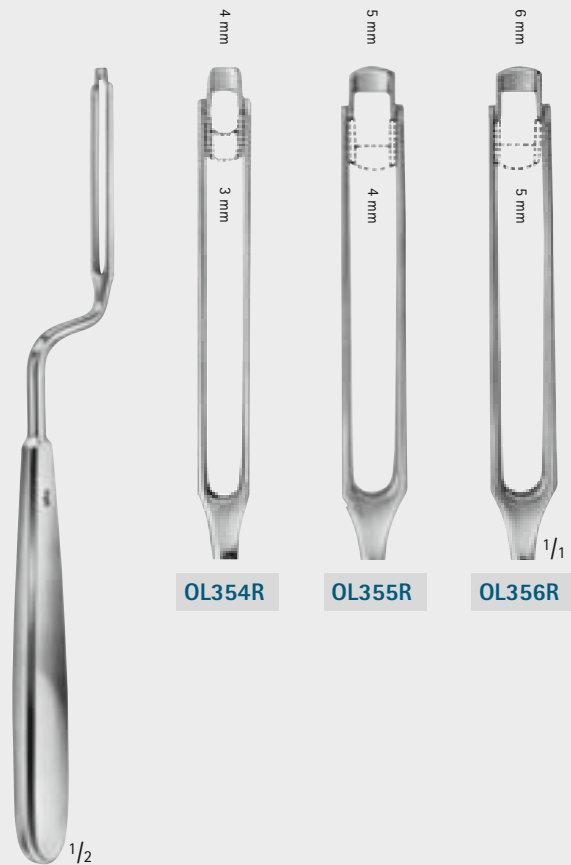

BALLENGER

OL354R-OL356R

Swivel knife, bayonet shaped

Schwingmesser, bajonettförmig

210 mm, 8 1/4"

FESS, Rhinology, Rhinoplasty – FESS, Rhinologie, Septum- und Nasenplastik

Cartilage Slitting Knife, Nasal Knives

Knorpelritz-, Nasenmesser



MASING

OL114R

Cartilage slitting knife,
curved blade, pointed
Knorpelritzmesser,
in der Spitze gebogen
130 mm, 5 1/8"



JOSEPH

OL102R-OL104R

double-edged nasal knives,
pointed
Plastikmesser
145 mm, 5 3/4"



JOSEPH

OL107R

Button-end knife, angled,
for removal of cartilage
Zugmesser zum Abtragen von
Knorpelvorsprüngen des Septums
175 mm, 6 7/8"

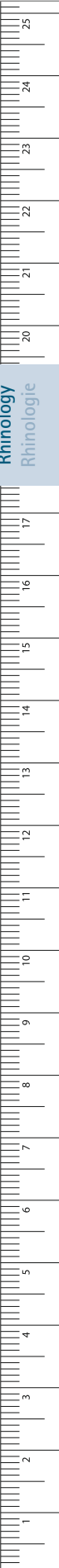

Rhinology
Rhinologie

FESS, Rhinology, Rhinoplasty – FESS, Rhinologie, Septum- und Nasenplastik

Nasal Knives, Milium Knife, Lupus Spatula

Nasen-, Milienmesser, Lupuspatel



Rhinology
Rhinologie



CONVERSE
OL109R
Button-end knife, curved
Plastikmesser, gebogen, Spitze verrundet
150 mm, 6"



JOSEPH
OL111R
Button-end knife, straight
Plastikmesser, gerade, Spitze verrundet
140 mm, 5 1/2"



COTTLE
OL112R
Septum knife
Septummesser
150 mm, 6"



COTTLE
OL113R
Septum knife, stiff blade with rounded edge
Septummesser, abgerundete Kanten
140 mm, 5 1/2"



TOENNIS
BA642R
Milium knife
Milienmesser
130 mm, 5 1/8"



VIDAL
OL699R
Lupus spatula
Lupuspatel
135 mm, 5 1/4"

FESS, Rhinology, Rhinoplasty – FESS, Rhinologie, Septum- und Nasenplastik

Nasal Saws, Raspatory, Elevators

Nasensägen, Raspatorium, Elevatorien



4.1 mm
35 mm

JOSEPH
OL448R
Nasal saw, straight
Nasensäge, gerade
195 mm, 7 3/4"

1/2

1/1

JOSEPH
OL451R
Nasal saw, bayonet shaped,
curved to the right
Nasensäge, bajonettförmig,
rechts gebogen
195 mm, 7 3/4"

1/2



JOSEPH
OL452R
Nasal saw, bayonet shaped,
curved to the left
Nasensäge, bajonettförmig,
links gebogen
195 mm, 7 3/4"



1/2



1/1

PENNINGTON
OL151R
Raspatory
Raspatorium
210 mm, 8 1/4"



1/2 1/1

1/1

COTTLE
OL152R
Elevator, graduated
Elevatorium mit
Graduierung
200 mm, 7 7/8"

1/2 1/1

1/1

MASING
OL153R
Elevator, graduated
Elevatorium mit
Graduierung
200 mm, 7 7/8"

1/2 1/1

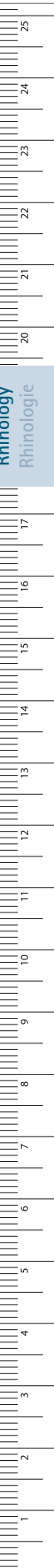

FESS, Rhinology, Rhinoplasty – FESS, Rhinologie, Septum- und Nasenplastik

Raspatories, Dissectors, Elevators

Raspatorien, Elevatoren, Dissektoren



Rhinology
Rhinologie

KILLIAN
OL170R
blunt/sharp
stumpf/scharf
185 mm, 7 1/4"

MAC DONALD
FK291R
blunt/blunt
stumpf/stumpf
185 mm, 7 1/4"

WATSON-CHEYNE
FK292R-FK293R
blunt/blunt
stumpf/stumpf
130 mm, 5 1/8"

FK292R
blunt/blunt
stumpf/stumpf
190 mm, 7 1/2"

FK293R
blunt/blunt
stumpf/stumpf
190 mm, 7 1/2"

FREER
OL164R
sharp/blunt
scharf/stumpf
180 mm, 7"

FREER
OL165R
blunt/sharp
stumpf/scharf
185 mm, 7 1/4"

FREER
OL154R
blunt/sharp
stumpf/scharf
185 mm, 7 1/4"

FREER-YASARGIL
OL166R
sharp/sharp
scharf/scharf
185 mm, 7 1/4"

FESS, Rhinology, Rhinoplasty – FESS, Rhinologie, Septum- und Nasenplastik

Raspatory, Elevators

Raspatorium, Elevatoren

HOWARTH
OL171R
 Raspatory,
 sharp/blunt
 Raspatorium,
 scharf/stumpf
 215 mm, 8 1/2"

FREER
OL159R
 Raspatory,
 sharp/sharp
 Raspatorium,
 scharf/scharf
 175 mm, 6 7/8"

COTTLE
OL155R
 Elevator,
 sharp/sharp
 Elevatorium,
 scharf/scharf
 200 mm, 7 7/8"

HILL
OL179R
 Raspatory,
 blunt/semi-sharp
 Raspatorium,
 stumpf/halbscharf
 220 mm, 8 3/4"

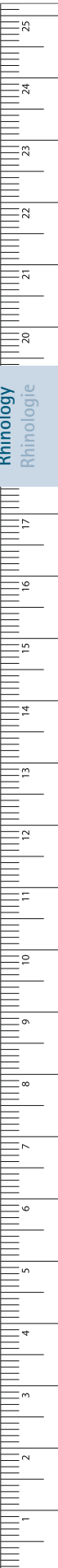

FESS, Rhinology, Rhinoplasty – FESS, Rhinologie, Septum- und Nasenplastik

Alar Retractors

Nasenflügelretraktoren

Rhinology
Rhinologie



FOMON

OL202R

Alar retractor, 2 prongs,
blunt/blunt

Nasenflügelretraktor, 2-zinkig,
stumpf/stumpf

145 mm, 5 3/4"



COTTLE

OL203R

Alar retractor, 2 prongs,
blunt/sharp

Nasenflügelretraktor, 2-zinkig,
stumpf/spitz

145 mm, 5 3/4"



COTTLE

OL204R

Alar retractor, 2 prongs,
sharp/blunt

Nasenflügelretraktor, 2-zinkig,
spitz/stumpf

145 mm, 5 3/4"



COTTLE

OL214R

Alar retractor, with saw
and knife guide, 2 prongs,
blunt/blunt

Nasenflügelretraktor, mit Säge-
oder Messerführung, 2-zinkig,
stumpf/stumpf

200 mm, 7 7/8"



OL210R

Alar retractor

Nasenflügelhaken

195 mm, 7 3/4"

FESS, Rhinology, Rhinoplasty – FESS, Rhinologie, Septum- und Nasenplastik

Nasal Retractor, Double-ended Retractor

Nasenretraktor, Doppelhaken



AUFRICHT

OK099R

Nasal retractor
Nasenretraktor
160 mm, 6 1/4"

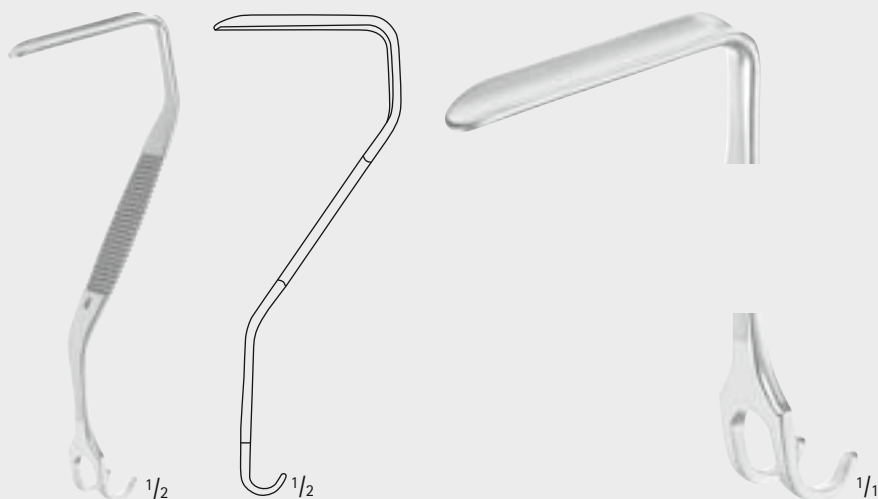

WALTER

OL218R

Double-ended retractor
Doppelhaken
130 mm, 5 1/8"

- Please find more hooks in chapter retractors and hooks, starting on page 290
- Weitere Wundhaken, siehe Kapitel Retraktoren und Wundhaken, ab Seite 290

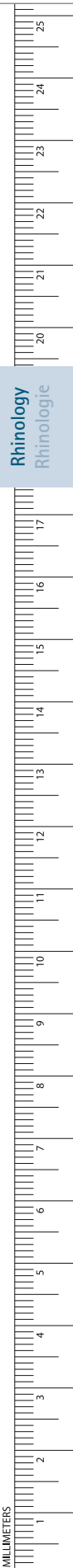

FESS, Rhinology, Rhinoplasty – FESS, Rhinologie, Septum- und Nasenplastik

Suction Dissectors, -Raspatories, Dissecting Suction Tube

Saugdissektoren, -raspatorium, Präpariersauger

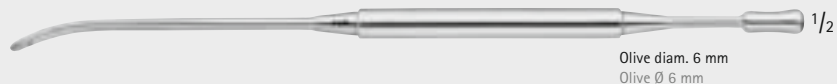
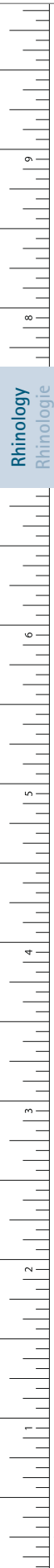

Olive diam. 6 mm
Olive Ø 6 mm

NEGUS

OL177R

Suction dissector
Saugdissektor
210 mm, 8 1/4"



Olive diam. 6 - 10 mm
Olive Ø 6 - 10 mm

GORNEY

OL168R

Suction dissector
Saugdissektor
180 mm, 7"



Olive diam. 6 - 9 mm
Olive Ø 6 - 9 mm

Art. No.	Diam. (mm)	Length
Art. Nr.	Ø (mm)	Länge
OL195R	4	200 mm, 7 7/8"
OL196R	5	200 mm, 7 7/8"

Suction raspatories, sharp, bayonet-shaped, with stylet
Saugraspatorium, scharf, bajonettförmig gebogen, mit Mandarin



Olive diam. 6 - 9 mm
Olive Ø 6 - 9 mm

LANDOLT

Art. No.	Diam. (mm)	Length
Art. Nr.	Ø (mm)	Länge
GF980R	3.2	200 mm, 7 7/8"

Dissecting suction tube for hypophysectomie and ENT, sharp angled point
Präpariersauger für Hypophysektomie und HNO, winklige Spitze, scharf

- Please find more suction cannulae in chapter suction instruments, starting on page 527
- Weitere Saugkanülen, siehe Kapitel Sauger, ab Seite 527

FESS, Rhinology, Rhinoplasty – FESS, Rhinologie, Septum- und Nasenplastik

Osteotomes, Septum Gouge

Osteotome, Septum-Hohlmeißel

OL321R
curved left
links gebogen

OL322R
curved right
rechts gebogen

OL323R
straight
gerade

MASING
OL321R-OL323R
Osteotome, single guarded
Osteotome
175 mm, 6 7/8"

OL338R **OL339R**

FOMON
OL338R-OL339R
Osteotome, single guarded
Osteotome mit einseitig verrundeter Ecke
170 mm, 6 3/4"

Diam. of tip: 4 mm
Knopf-Ø: 4 mm

Diam. of tip: 6 mm
Knopf-Ø: 6 mm

DO704R **DO706R**

DO704R-DO706R
Osteotomes for septum
Nasenseptum Osteotome
185 mm, 7 1/4"

OL326R **OL327R**

OL328R **OL329R**

CINELLI
OL326R-OL329R
Osteotome, double guarded, straight
Osteotome mit verrundeten Ecken, gerade
160 mm, 6 1/4"

OL318R
Septum gouge, with notch, straight
Septum-Hohlmeißel mit Kerbe, gerade
150 mm, 6"

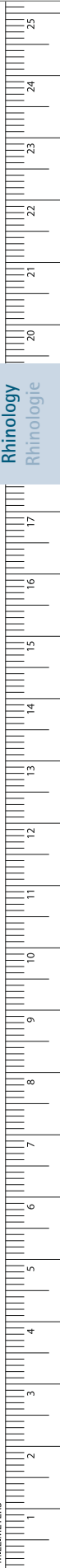

Rhinology
Rhinologie

FESS, Rhinology, Rhinoplasty – FESS, Rhinologie, Septum- und Nasenplastik

Osteotomes

Osteotome

Rhinology
Rhinologie



COTTLE

Art. No. Art. Nr.	Tip Size (mm) Arbeitsende (mm)	Length Länge
OL294R	4	180 mm, 7"
OL296R	6	180 mm, 7"
OL298R	8	180 mm, 7"
OL299R	10	180 mm, 7"
OL300R	12	180 mm, 7"

with depth markings
mit Graduierung

COTTLE

Art. No. Art. Nr.	Tip Size (mm) Arbeitsende (mm)	Length Länge
OL301R	4	180 mm, 7"
OL302R	7	180 mm, 7"
OL303R	9	180 mm, 7"
OL304R	12	180 mm, 7"

Chisel Osteotomes with depth markings
mit einseitigem Anschliff und Graduierung

COTTLE
OL305R
with depth markings
mit Graduierung
180 mm, 7"

8 mm

COTTLE
OL307R
Fishtail osteotom, with protected ends
Fischschwanzosteotom
180 mm, 7"

2 mm 4 mm 6 mm 7 mm 9 mm 12 mm

OL270R **OL271R** **OL272R** **OL273R** **OL274R** **OL275R**

COTTLE
OL270R-OL275R
Osteotome with depth markings and handle, straight
Osteotom mit Graduierung und Griffbalken, gerade
180 mm, 7"

- Please find further bone instruments in chapter bone instruments, starting on page 199
- Weitere Knocheninstrumente siehe Kapitel Knocheninstrumente, ab Seite 199

FESS, Rhinology, Rhinoplasty – FESS, Rhinologie, Septum- und Nasenplastik

Gouges, Osteotomes

Hohlmeißel, Osteotome

6 mm

1/2

KILLIAN
OL336R

Septum gouge round cutting edge, bayonet shaped
Septum-Hohlmeißel mit runder Schneide, bajonettförmig gebogen
170 mm, 6 3/4"

6 mm

1/2

KILLIAN-CLAUS
OL335R

Septum gouge with notch, bayonet shaped
Septum-Hohlmeißel mit Kerbe, bajonettförmig gebogen
170 mm, 6 3/4"

2 mm 3 mm 4 mm 7 mm 9 mm

1/1

OL390R **OL391R** **OL392R** **OL393R** **OL394R**

WALTER
OL390R-OL394R

Osteotome
Osteotome
190 mm, 7 1/2"

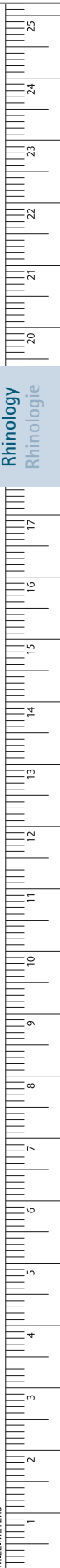

FESS, Rhinology, Rhinoplasty – FESS, Rhinologie, Septum- und Nasenplastik

Chisels

Meißel



Rhinology
Rhinologie

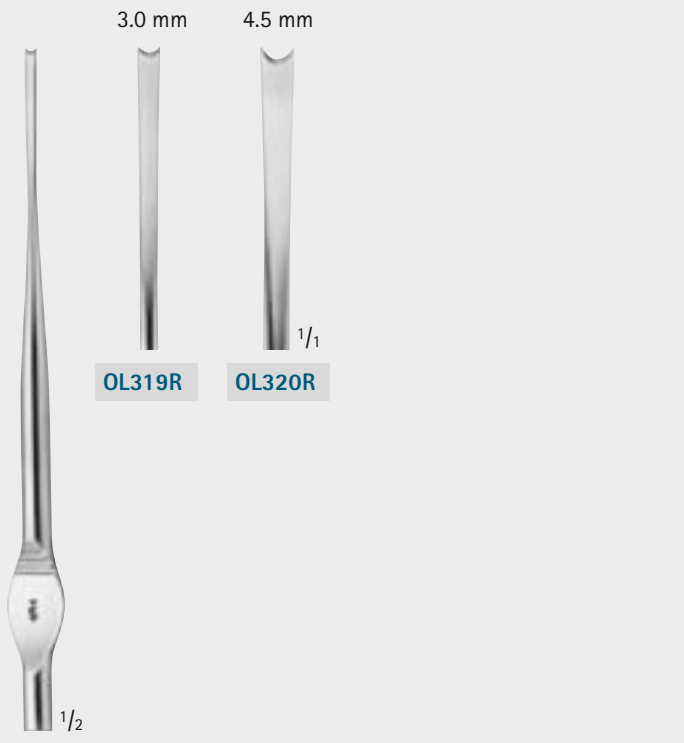

3.0 mm
4.5 mm
OL319R
OL320R 1/1

WALTER

OL319R-OL320R

Chisels with notch, double guarded
Flachmeißel mit Hohlkehle, Spitzen verrundet
180 mm, 7"

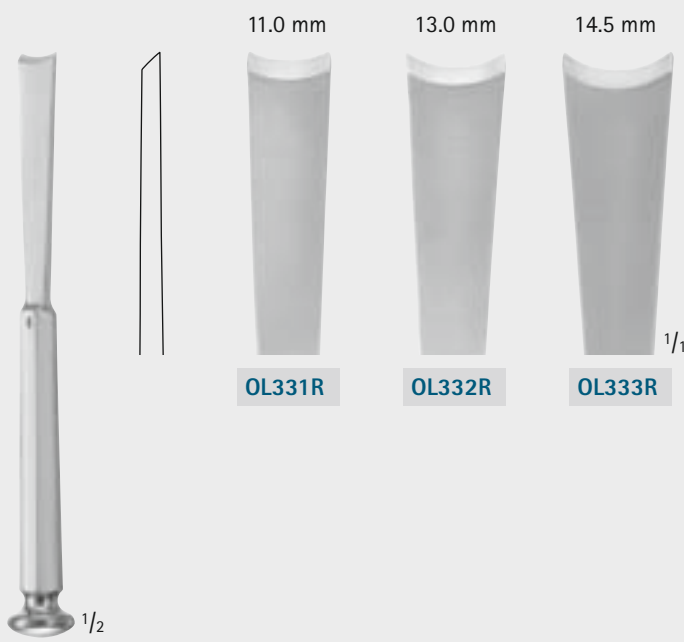

11.0 mm
13.0 mm
14.5 mm
OL331R
OL332R
OL333R 1/1

MC INDOE

OL331R-OL333R

Chisels with notch, double guarded
Meißel mit Hohlkehle, Spitzen verrundet
155 mm, 6 1/8"

FESS, Rhinology, Rhinoplasty – FESS, Rhinologie, Septum- und Nasenplastik

Bone Crusher, Micro Bone Mill, Bone Mill Cleaners

Knochen-Knorpelquetsche, Mikro-Knochenmühle, Reinigungsinstrumente

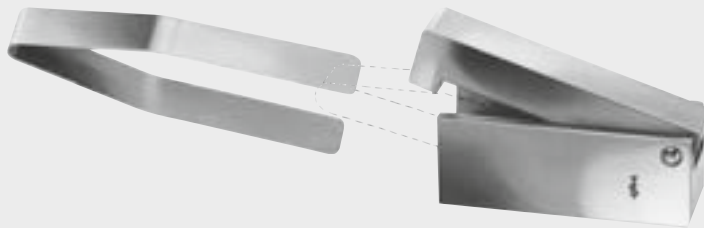

OL460R

Bone crusher, for preparation of cartilage implant material, complete with clamp
Knochen-Knorpelquetsche mit Metallklammer zum Entnehmen der Knochen-Knorpeltrümmer



OL461R

Bone crusher, for pieces up to 40 mm diameter
Knochen-Knorpelquetsche für Stücke bis zu 40 mm Durchmesser

ERGOPLANT Micro Bone-Mill

- small and handy
- interchangeable cutting disks
- cutting disks available for finer or coarser bone particles
- easy to clean due special cleaning instruments
- easy mounting and demounting
- maximum bone yield requires less bone harvesting

ERGOPLANT Mikro Knochenmühle

- kompakt und handlich
- auswechselbare Schneideplatten
- Schneideplatten für feine oder grobe Knochenpartikel erhältlich
- leicht zu reinigen durch spezielle Reinigungsinstrumente
- einfache Montage / Demontage
- maximale Knochenausbeute, dadurch weniger Knochenentnahme nötig

■ ERGOPLANT



DX801R

Micro bone mill (delivered with coarse cutting disk DX803R)
Mikro-Knochenmühle (Lieferung mit grober Schneideplatte DX803R)

■ ERGOPLANT

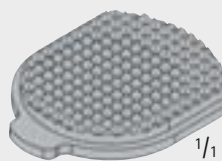

DX802R

Cutting disc for DX801R, fine
Schneideplatte für DX801R, fein

■ ERGOPLANT

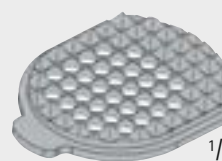

DX803R

Cutting disc for DX801R, coarse
Schneideplatte für DX801R, grob

■ ERGOPLANT



DX810R

Bone mill cleaner for DX802R, fine
Reinigungsinstrument für DX802R, fein
195 mm, 7 3/4"

■ ERGOPLANT



DX811R

Bone mill cleaner for DX802R, coarse
Reinigungsinstrument für DX802R, grob
195 mm, 7 3/4"

FESS, Rhinology, Rhinoplasty – FESS, Rhinologie, Septum- und Nasenplastik

Septum Straightening Forceps

Septumzangen



Rhinology
Rhinologie



ASH
OL470R
220 mm, 8 3/4"

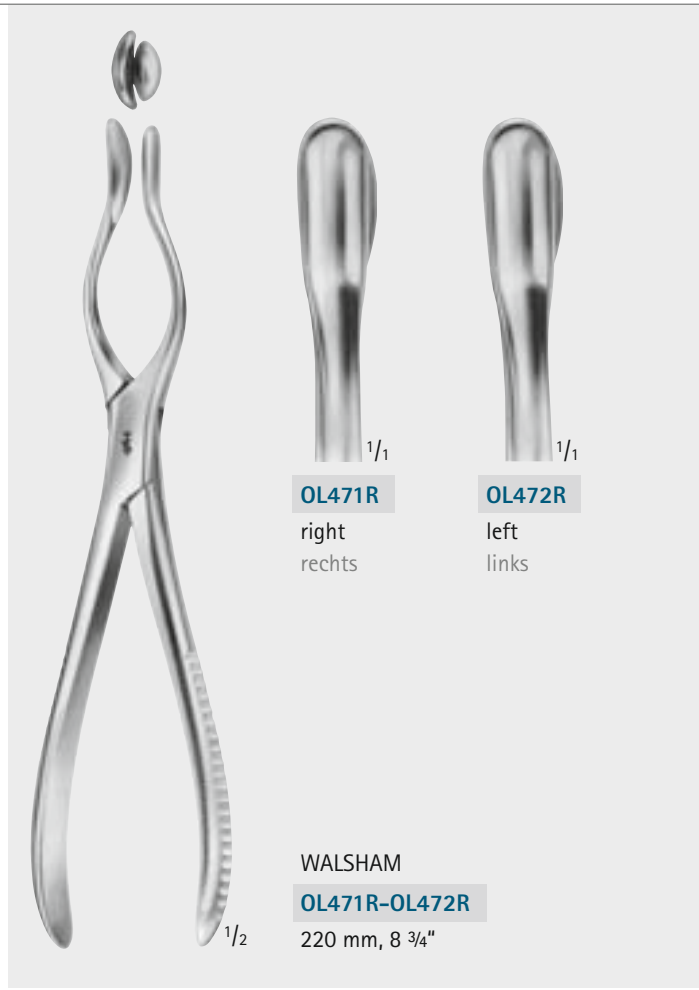

OL471R
right
rechts

OL472R
left
links

WALSHAM
OL471R-OL472R
220 mm, 8 3/4"



COTTLE-WALSHAM
OL473R
with aseptic lock
mit aseptischem Schluss
220 mm, 8 3/4"

FESS, Rhinology, Rhinoplasty – FESS, Rhinologie, Septum- und Nasenplastik

Cartilage Morselizer Forceps, Nasal Fracture-, Septum Elevator, Columella Clamp, Forceps

Knorpelritzzange, Nasenfrakturaufrichter, Columella-Klemme, Fixierpinzette



OL474R

Cartilage morselizer forceps with removeable guard, converts cartilage into a membranous-like structure, which permits repositioning of the septum to midline

Knorpelritzzange mit abnehmbarem einseitigem Schutz für rechts und links sowie ohne Schutz für ein gleichzeitiges Einritzen beider Knorpelseiten
200 mm, 7 7/8"



BOIES

OL477R

Nasal fracture elevator, a strong instrument with blunt edges for elevating nasal fractures oval
Nasenfrakturaufrichter, ovale Form, mit stumpfen Kanten
180 mm, 7"



GOLDMANN

OL479R

Nasal fracture elevator, rounded (displacer)
Nasenfrakturaufrichter, runde Form
200 mm, 7 7/8"



COTTLE

OL010R

Columella clamp, with fixation bearings and adjusting screw
Columella-Klemme, mit feststehenden Fixierrollen und Stellschraube
100 mm, 4"

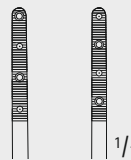

toothed and serrated
gezahnt und gerieft

COTTLE

OL011R

Forceps
Fixierpinzette
140 mm, 5 1/2"

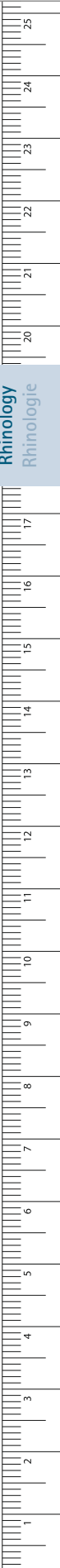

Rhinology
Rhinologie

FESS, Rhinology, Rhinoplasty – FESS, Rhinologie, Septum- und Nasenplastik

Nasal Polypus Snare, Wire Loops For Nasal Snares

Nasenpolypenschnürer, Schlingen für Nasenpolypenschnürer



KRAUSE
OK260R-OK262R
 Nasal Polypus snare, angled
 Nasenpolypenschnürer, kniegebogen
 250 mm, 9 3/4"

OK261R
 Tube only
 Rohraufsatz alleine

OK262R
 Wire guide only
 Drahtführer alleine

KRAUSE-VOSS
OK263R
 Nasal polypus snare, angled, complete with
 OK264R tube vertical, OK265R tube horizontal
 Nasenpolypenschnürer, kniegebogen, komplett mit
 OK264R Rohraufsatz vertikal, OK265R Rohraufsatz horizontal
 250 mm, 9 3/4"

WILDE
OK270R
 Nasal polypus snare, bayonet shaped
 Nasenpolypenschnürer, bayonettförmig gebogen
 250 mm, 9 3/4"

OK293R
 Wire loops for nasal snares,
 diam. 0.3 mm
 Sales unit: PAK = Package of 100 pieces
 Schlingen für Nasenpolypenschnürer,
 Ø 0,3 mm
 Bestelleinheit: PAK = Packung à 100 Stück

FESS, Rhinology, Rhinoplasty – FESS, Rhinologie, Septum- und Nasenplastik

Derma Punch, Dermatomes, Spare Blade, Skin Straightening Plate

Hautstanze, Dermatom, Ersatzklingen, Spannplatte



KEYES

OL670R

Derma punch, complete with 5 interchangeable tips, handle and rack

Hautstanze, komplett, mit 5 auswechselbaren Aufsätzen, Griff und Gestell



BA708R

Spare blade only
Ersatzklinge allein



BA709R

Skin straightening plate only
Spannplatte allein

SCHINK

BA706R

Dermatome, adjustable from 0.1 to 2.0 mm, complete, with 1 interchangeable blade and 2 skin straightening plates

Dermatom, einstellbar von 0,1 bis 2,0 mm, komplett, mit 1 auswechselbaren Klinge und 2 Spannplatten
300 mm, 11 3/4"



SILVER

BA716SU

Spare blade, sterile

Sales unit:

PAK = Package of 5 pieces

Ersatzklinge, steril

Bestelleinheit:

PAK = Packung à 5 Stück

40 mm, 1 1/2"

SILVER

BA715R

Skin graft knife without blade

Dermatom, ohne Klinge

190 mm, 7 1/2"



Rhinology
Rhinologie



MILLIMETERS

FESS, Rhinology, Rhinoplasty – FESS, Rhinologie, Septum- und Nasenplastik



Rhinology
Rhinologie

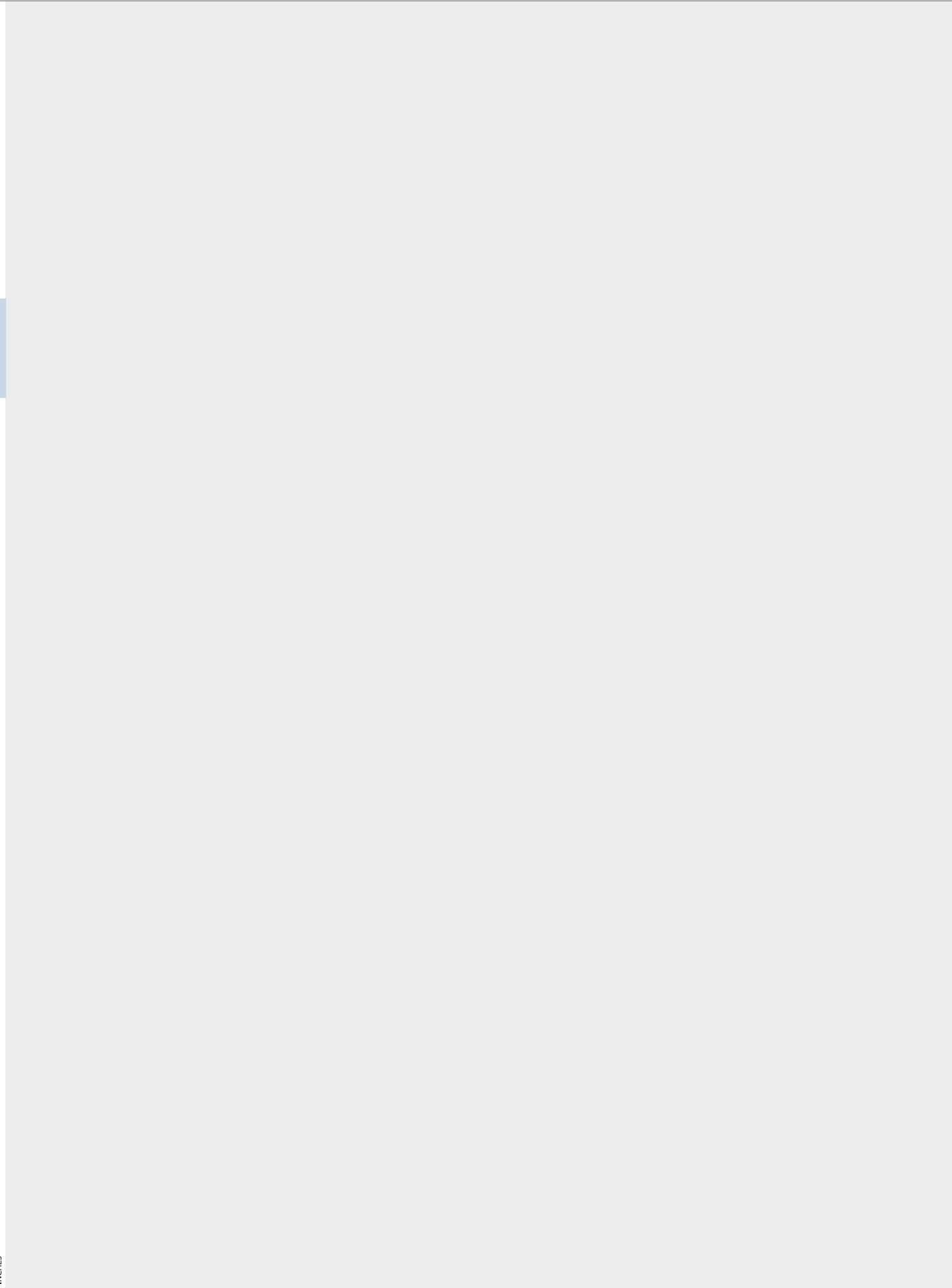

Adenoidectomy, Tonsillectomy
Adenotomie, Tonsillektomie



Adenoidectomy, Tonsillectomy – Adenotomie, Tonsillektomie

Tongue Depressors

Zungenspatel



Adenotomy
Adenotomie



16 mm

1/2

OM202R

145 mm, 5 3/4"



19 mm

23 mm

1/2

OM203R

140 mm, 5 1/2"

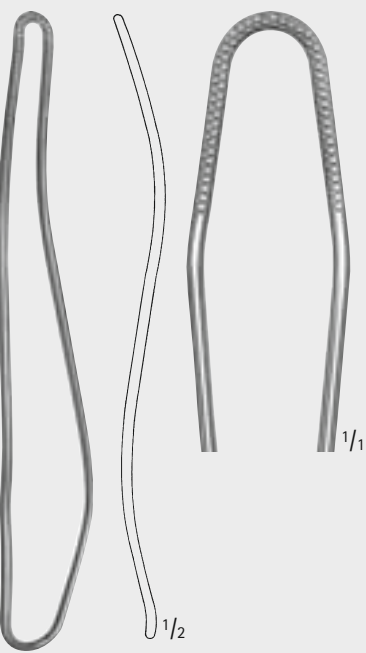

1/1

FRENZEL

OM212R

165 mm, 6 1/2"



19 mm

23 mm

1/2

BUCHWALD

OM205R

180 mm, 7"

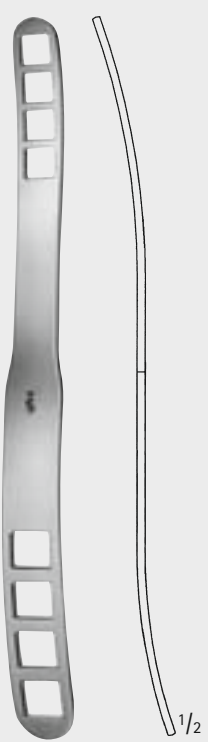

1/2

BRÜNING'S

OM208R

190 mm, 7 1/2"



1/2

MORITZ-SCHMIDT

OM640R

190 mm, 7 1/2"

Adenoidectomy, Tonsillectomy – Adenotomie, Tonsillektomie

Tongue Depressors, Tongue Forceps

Zungenspatel, Zungenzange



1/2

LACK

Art. No.	Width (mm)
Art. Nr.	Breite (mm)

OM220R 13.0

OM221R 19.0

OM222R 22.0

curved
gebogen



1/2

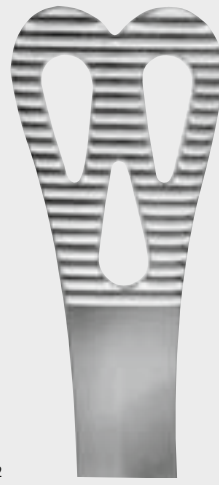

OM236R



1/1

OM237R

WEDER

OM236R-OM237R

fenestrated
gefenstert
125 mm, 5"

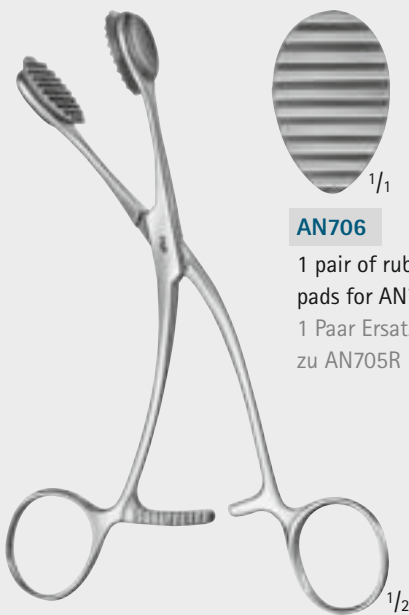

1/1

AN706

1 pair of rubber
pads for AN705R
1 Paar Ersatzgummi
zu AN705R

1/2

YOUNG

AN705R

Tongue forceps
Zungenzange
165 mm, 6 1/2"

Adenotomie
Adenotomie

MILLIMETERS

Adenoidectomy, Tonsillectomy – Adenotomie, Tonsillektomie

Tongue Retractors

Zungenretraktoren



Adenotomy
Adenotomie



HARTMANN
OM230R
with fenestrated handle
mit Gittergriff
150 mm, 6"



TOBOLD
OM235R
160 mm, 6 1/4"

■ ERGOPLANT



DX105R
190 mm, 7 1/2"

Adenoidectomy, Tonsillectomy – Adenotomie, Tonsillektomie

Mouth Gags

Mundsperrerr



HEISTER

OM030R

130 mm, 5 1/8"



MOLT

OM038R

for children
für Kinder
100 mm, 4"



DOYEN-COLLIN

OM040R

120 mm, 4 3/4"

TA009706

Spare silicone tube only, latex-free
Ersatz-Silikonschlauch, Latex-frei
Length/Länge: 1 m



DOYEN-JANSEN

OM041R

140 mm, 5 1/2"

TA005771

Spare silicone tube only,
latex-free
Ersatz-Silikonschlauch,
Latex-frei
Length/Länge: 1 m

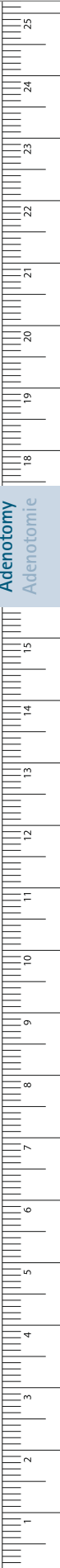

Adenoidectomy, Tonsillectomy – Adenotomie, Tonsillektomie

ERGOPLANT Mouth Wedges, Chain

ERGOPLANT Mundkeile, Kette

- The mouth wedges are particularly advantageous for longer implantations and also provide support for the patient.
- Die Mundkeile sind besonders bei längeren Implantationen von Vorteil und unterstützen zudem den Patienten.

Adenotomy
Adenotomie



DX113–DX115

Sales unit:
PAK = Package of 2 pieces
Bestelleinheit:
PAK = Packung à 2 Stück

stainless steel

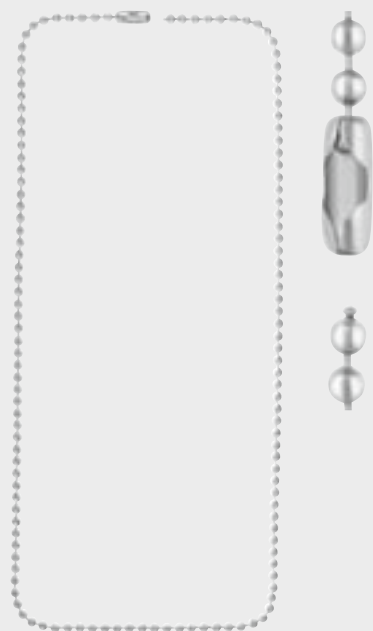

DX120R

Chain with clip lock for DX113–DX115
Kette mit Klemmverschluss für DX113–DX115
450 mm, 17 3/4"



DX113

Silicone mouth wedge
Size: S
Silikon-Mundkeil
Größe: S

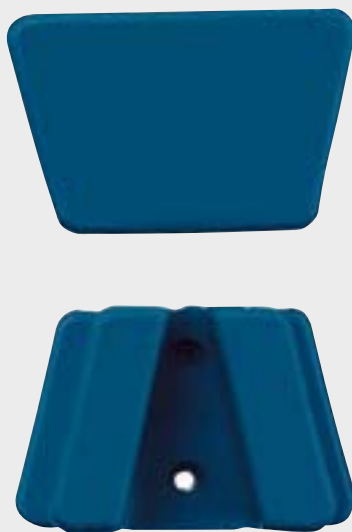

DX114

Silicone mouth wedge with metal core
Size: M
Silikon-Mundkeil mit Metallkern
Größe: M



DX115

Silicone mouth wedge with metal core
Size: L
Silikon-Mundkeil mit Metallkern
Größe: L

INCHES

Adenoidectomy, Tonsillectomy – Adenotomie, Tonsillektomie

Mouth Gags

Mundsperrer



FERGUSSON-ACKLAND

OM044R

145 mm, 5 3/4"



OM047R

125 mm, 5"



ROSER-KÖNIG

OM048R

160 mm, 6 1/4"



ROSER-KÖNIG

OM049R

185 mm, 7 1/4"

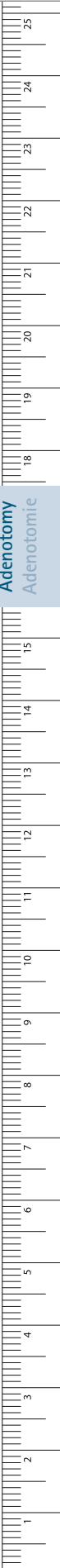

Adenoidectomy, Tonsillectomy - Adenotomie, Tonsillektomie

Mouth Gag

Mundsperrerr

Adenotomy
Adenotomie

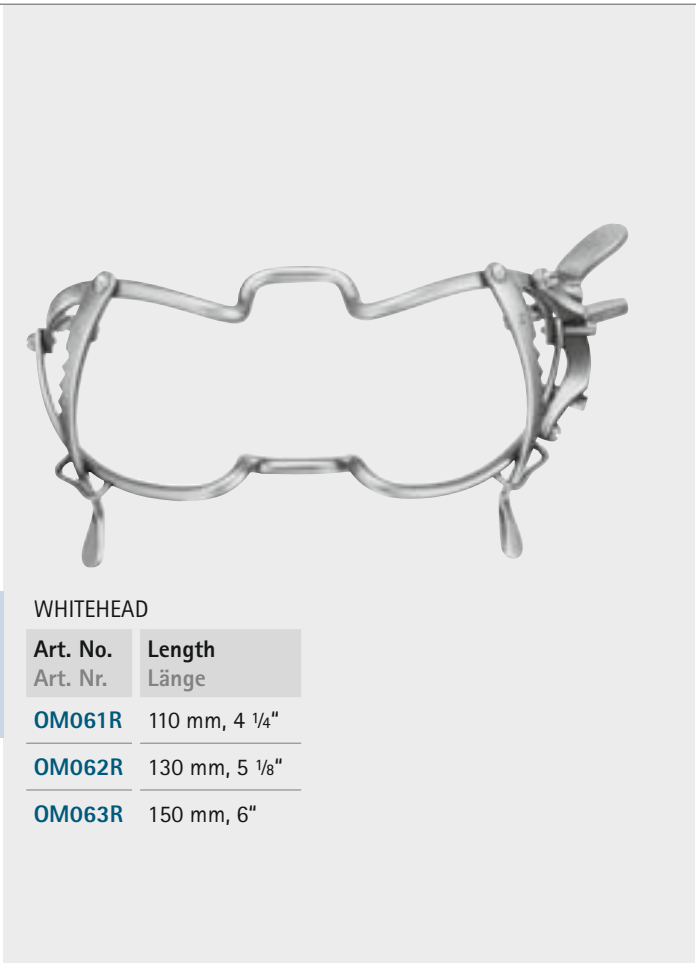

WHITEHEAD

Art. No.	Length
Art. Nr.	Länge
OM061R	110 mm, 4 1/4"
OM062R	130 mm, 5 1/8"
OM063R	150 mm, 6"

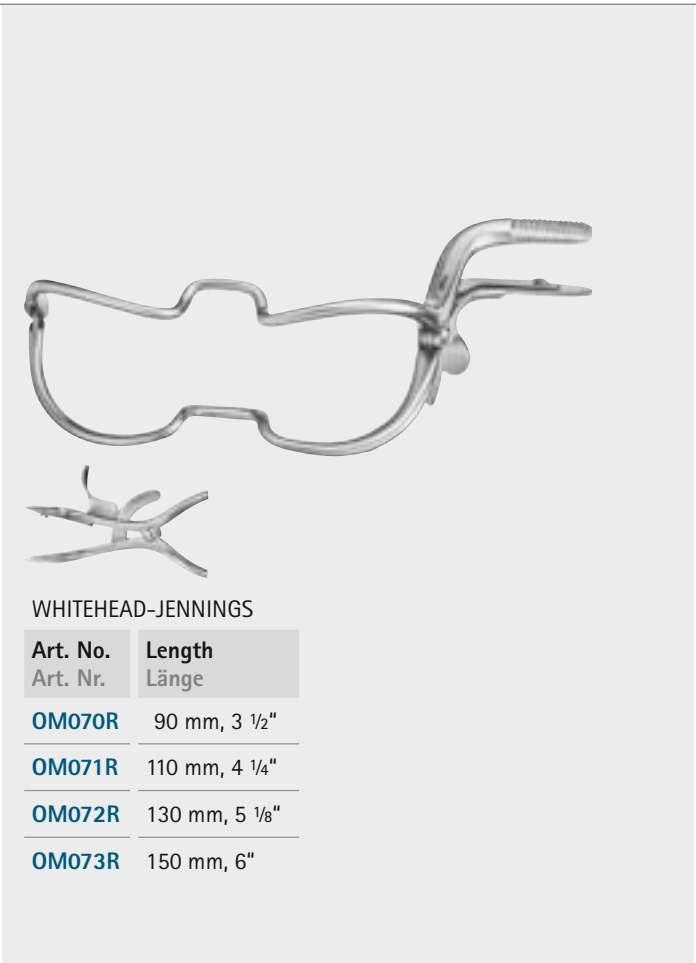

WHITEHEAD-JENNINGS

Art. No.	Length
Art. Nr.	Länge
OM070R	90 mm, 3 1/2"
OM071R	110 mm, 4 1/4"
OM072R	130 mm, 5 1/8"
OM073R	150 mm, 6"

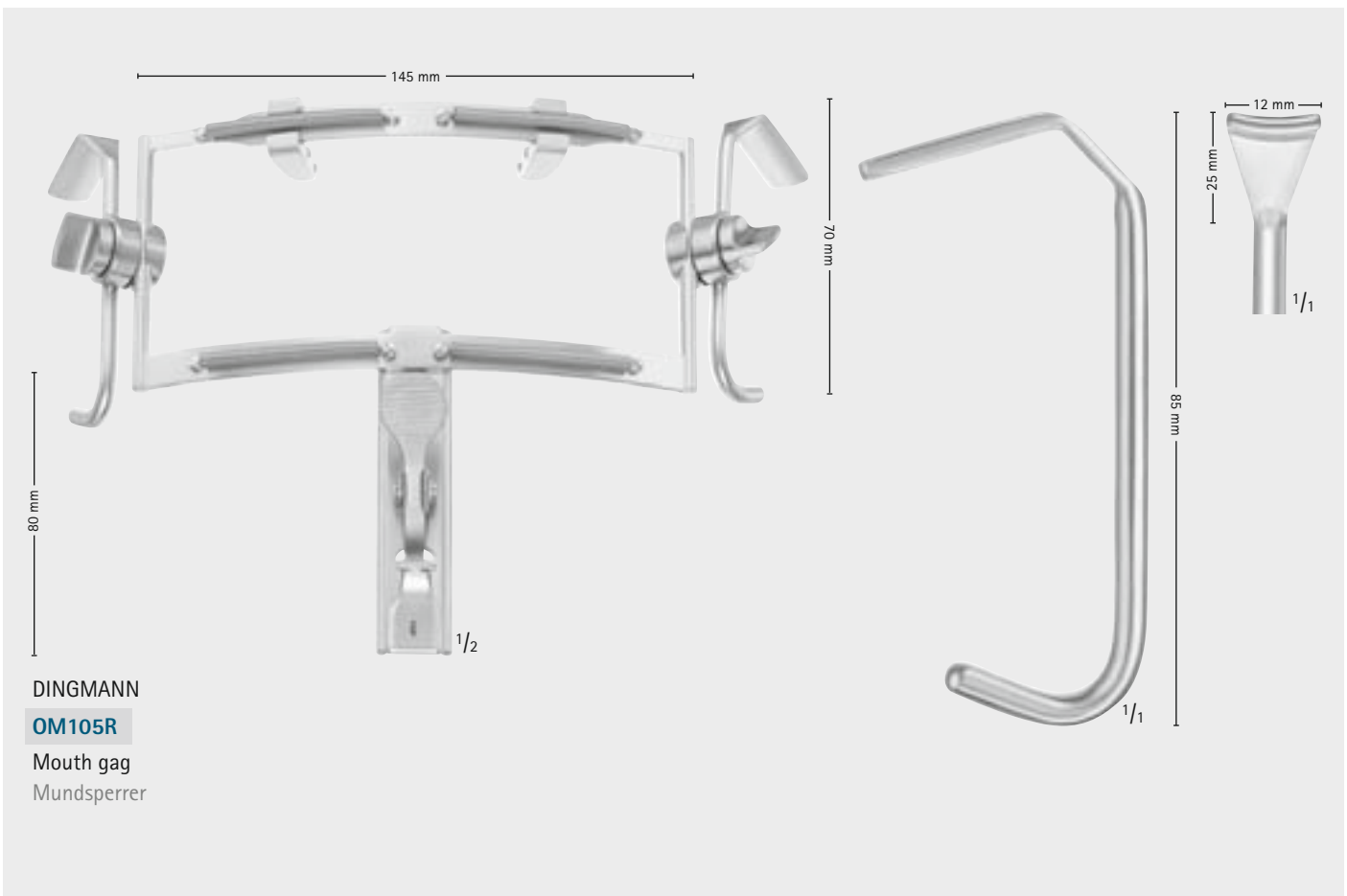

DINGMANN

OM105R

Mouth gag
Mundsperrerr

Adenoidectomy, Tonsillectomy – Adenotomie, Tonsillektomie

Frame for Mouth Gag, Palate Plate, Silicone Insert
 Bügel für Mundsperrer, Gaumenplatte, Silikoneinlagen

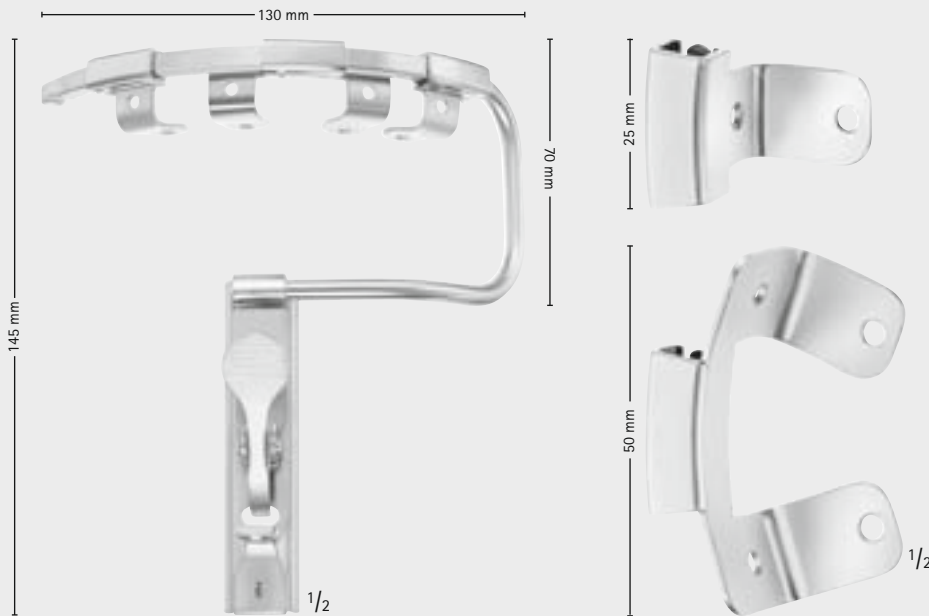

DAVIS-MEYER

OM169R

Frame only, with 2 single bites and 1 double bite, with interchangeable silicone inserts, suitable for all tongue depressors as shown on pages 125-131
 Bügel, allein, mit 2 Einzelgebissplatten und 1 Doppelgebissplatte mit auswechselbaren Silikoneinlagen, passend für alle Zungenspatel, siehe Seite 125-131



OM179R

Palate plate to use with OM169R, for toothless patients
 Gaumenplatte zu Bügel OM169R, für zahnlose Patienten



MC IVOR

OM104R

Frame only, suitable for all tongue depressors as shown on pages 125-131
 Bügel, allein, passend für alle Zungenspatel, siehe Seite 125-131



OM170

Silicone insert only for OM104R, OM116R, OM118R, OM119R, OM169R
 Silikoneinlagen allein, ohne Abb. für OM104R, OM116R, OM118R, OM119R, OM169R

Adenotomie
 Adenotomie

MILLIMETERS

Adenoidectomy, Tonsillectomy – Adenotomie, Tonsillektomie

Frame for Mouth Gag

Bügel für Mundsperrerr

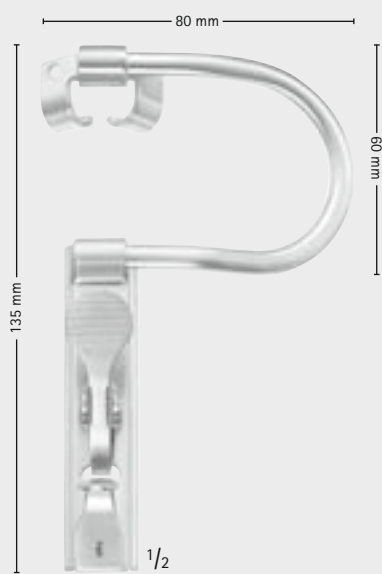

DAVIS-BOYLE
OM118R

Frame only, for children, with interchangeable silicone inserts, suitable for all tongue depressors as shown on pages 125-131
Bügel, allein, für Kinder, mit auswechselbaren Silikoneinlagen passend für alle Zungenspatel, siehe Seite 125-131

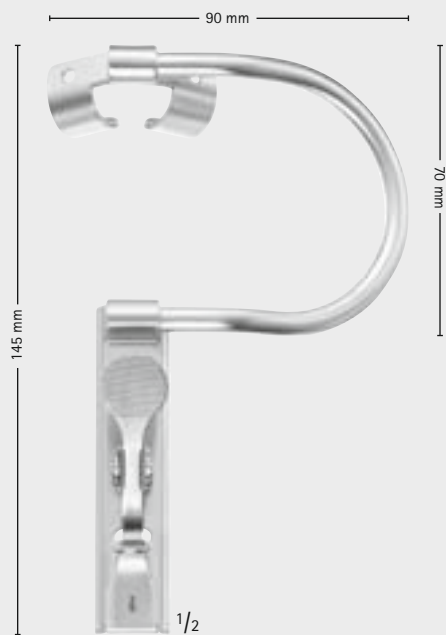

DAVIS-BOYLE
OM119R

Frame only, for adolescents, with interchangeable silicone inserts, suitable for all tongue depressors as shown on pages 125-131
Bügel, allein, für Jugendliche, mit auswechselbaren Silikoneinlagen passend für alle Zungenspatel, siehe Seite 125-131



DAVIS-BOYLE
OM116R

Frame only, for adults, with interchangeable silicone inserts, suitable for all tongue depressors as shown on pages 125-131
Bügel, allein, für Erwachsene, mit auswechselbaren Silikon-einlagen passend für alle Zungenspatel, siehe Seite 125-131

Adenoidectomy, Tonsillectomy – Adenotomie, Tonsillektomie

Tongue Blades

Zungenspatel



RUSSEL-DAVIS

Art. No.	Blade size (mm)
Art. Nr.	Blattgröße (mm)
OM171R	29 x 67
OM172R	33 x 75
OM173R	38 x 85
OM174R	40 x 92
OM175R	46 x 100

A groove holds the endotracheal tube, protects it from moving, kinking or closure by teeth, suitable for OM104R, OM105R, OM116R, OM118R, OM119R, OM169R

Mit Mittelrinne für Intubationstubus, passend für OM104R, OM105R, OM116R, OM118R, OM119R, OM169R

Adenotomie
Adenotomie

MILLIMETERS

Adenoidectomy, Tonsillectomy – Adenotomie, Tonsillektomie

Tongue Blades

Zungenspatel

Adenotomy
Adenotomie



RUSSEL-DAVIS

Art. No.	Blade size (mm)
Art. Nr.	Blattgröße (mm)
OM176R	18 x 57
OM177R	22 x 67
OM178R	25 x 75

Narrow pattern, with groove for endotracheal tubes, suitable for OM104R, OM105R, OM116R, OM118R, OM119R, OM169R

Extra schmale Modelle, allein, mit Mittelrinne für Intubationstubus, passend für OM104R, OM105R, OM116R, OM118R, OM119R, OM169R

Adenoidectomy, Tonsillectomy – Adenotomie, Tonsillektomie

Tongue Blades

Zungenspatel



GAST

Art. No.	Blade size (mm)
Art. Nr.	Blattgröße (mm)
OM181R	28 x 64
OM182R	34 x 74
OM183R	38 x 87

only, with groove for endotracheal tubes and lateral slot,
suitable for OM104R, OM105R, OM116R, OM118R,
OM119R, OM169R

allein, mit Mittelrinne für Intubations-Katheter und
seitlichem Einschnitt, passend für OM104R, OM105R,
OM116R, OM118R, OM119R, OM169R

Adenotomie
Adenotomie

MILLIMETERS

Adenoidectomy, Tonsillectomy – Adenotomie, Tonsillektomie

Tongue Blades

Zungenspatel

Adenotomy
Adenotomie



OM101R



OM102R



OM103R



MC IVOR

Art. No.	Blade size (mm)
Art. Nr.	Blattgröße (mm)
OM101R	25 x 55
OM102R	25 x 62
OM103R	25 x 75

only, suitable for OM104R, OM105R, OM116R,
OM118R, OM119R, OM169R
allein, passend für OM104R, OM105R, OM116R,
OM118R, OM119R, OM169R



Adenoidectomy, Tonsillectomy – Adenotomie, Tonsillektomie

Tongue Blades

Zungenspatel



DAVIS-BOYLE

Art. No. Art. Nr.	Blade size (mm) Blattgröße (mm)	Description Beschreibung
OM111R	19 x 25	without anesthesia channel ohne Insufflationsrohr
OM112R	25 x 62	with anesthesia channel mit Insufflationsrohr
OM113R	25 x 75	with anesthesia channel mit Insufflationsrohr
OM114R	25 x 92	with anesthesia channel mit Insufflationsrohr
OM115R	25 x 108	with anesthesia channel mit Insufflationsrohr

only, suitable for OM104R, OM105R, OM116R,
OM118R, OM119R, OM169R
allein, passend für OM104R, OM105R, OM116R,
OM118R, OM119R, OM169R

Adenotomie
Adenotomie

MILLIMETERS

Adenoidectomy, Tonsillectomy – Adenotomie, Tonsillektomie

Tongue Blades

Zungenspatel

Adenotomy
Adenotomie



OM154R



OM155R



OM157R



OM156R



OM158R

DOUGHTY

Art. No. Art. Nr.	Blade size (mm) Blattgröße (mm)
OM154R	65
OM155R	75
OM156R	90
OM157R	102
OM158R	115

with slot for endotracheal tubes for use with
OM116R, OM118R, OM119R DAVIS-BOYLE frames
mit Mittelrinne für Intubationstubus, passend zu
OM116R, OM118R, OM119R DAVIS-BOYLE Bügeln

Adenoidectomy, Tonsillectomy – Adenotomie, Tonsillektomie

Tongue Blades

Zungenspatel

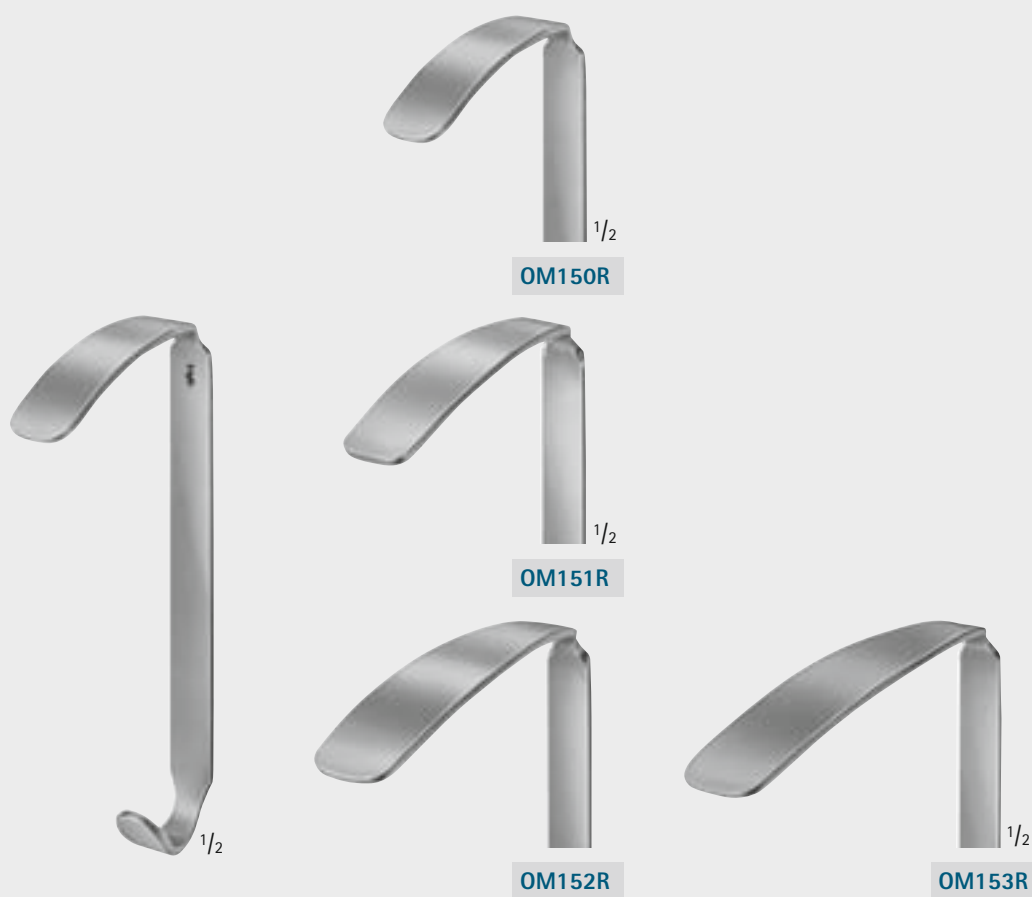

OM150R

OM151R

OM152R

OM153R

Art. No. Art. Nr.	Blade size (mm) Blattgröße (mm)
OM150R	65
OM151R	75
OM152R	90
OM153R	102

plain for use with OM116R, OM118R, OM119R
DAVIS-BOYLE frames
allein, passend zu OM116R, OM118R, OM119R
DAVIS-BOYLE Bügeln

Adenotomie
Adenotomie

MILLIMETERS

Adenoidectomy, Tonsillectomy – Adenotomie, Tonsillektomie

Chest Support with Accessories

Bruststütze mit Zubehör

Adenotomy
Adenotomie



NEGUS

OM185R

Chest Support, for use with tongue blades and mouth gag

Bruststütze

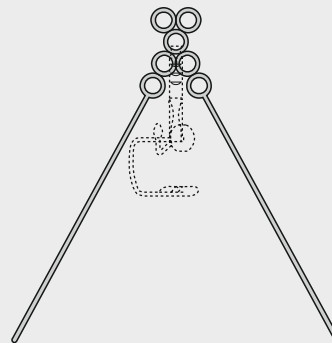

DRAFFIN

OM186R

Bipod fitted with 4 rings for varying heights

Rahmen mit 4 Stufen zur Höheneinstellung

480 mm, 18 7/8"

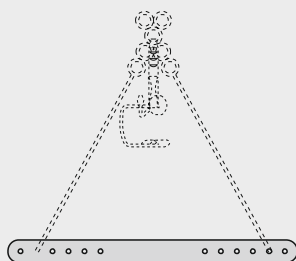

MAGAURAN

OM187R

Plate for holding Draffin bipod

Platte zum Befestigen des

Draffin-Rahmens

405 mm, 16"

INCHES

Adenoidectomy, Tonsillectomy – Adenotomie, Tonsillektomie

Organ- and Tissue Grasping Forceps Hakenfazzzangen, Arterienfazzzange

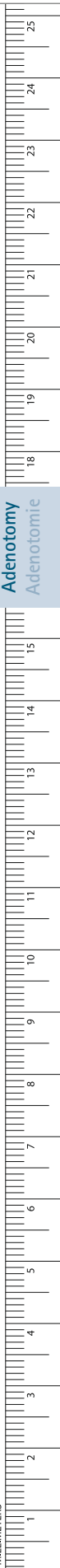
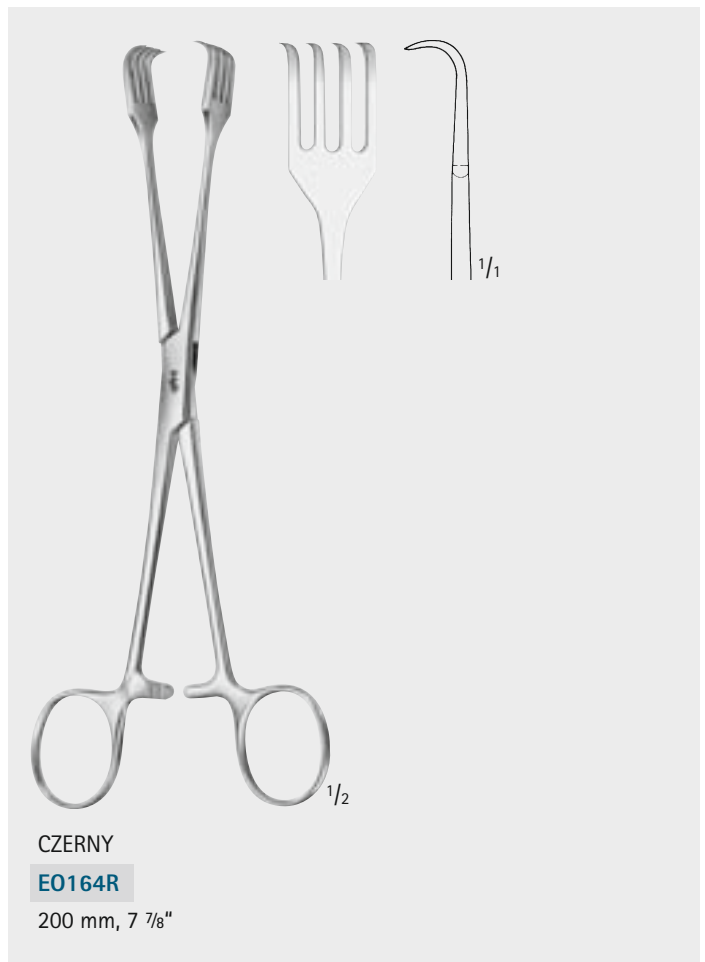
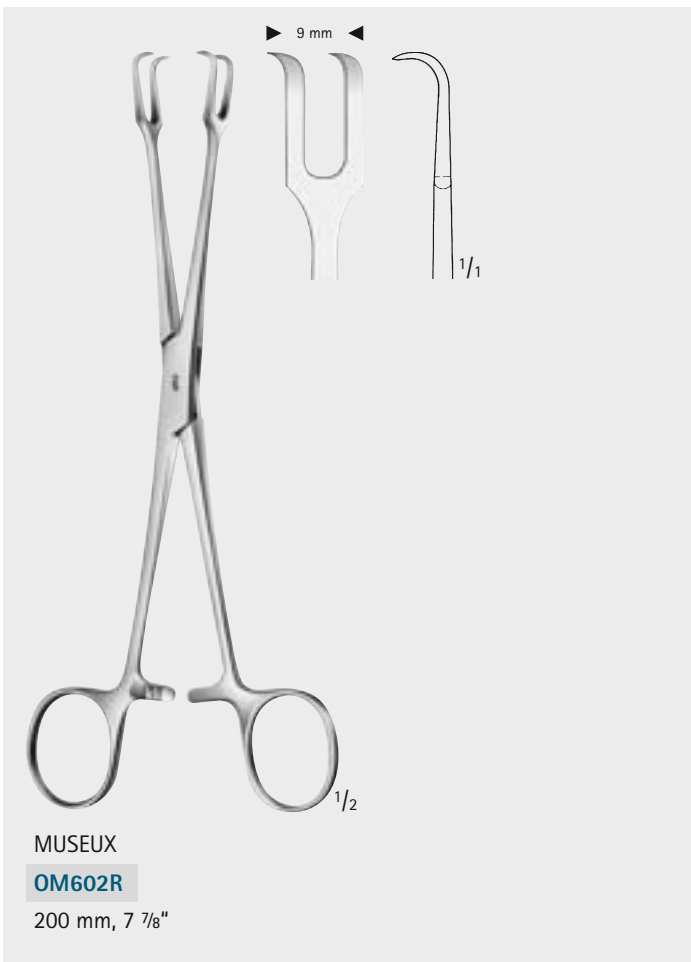
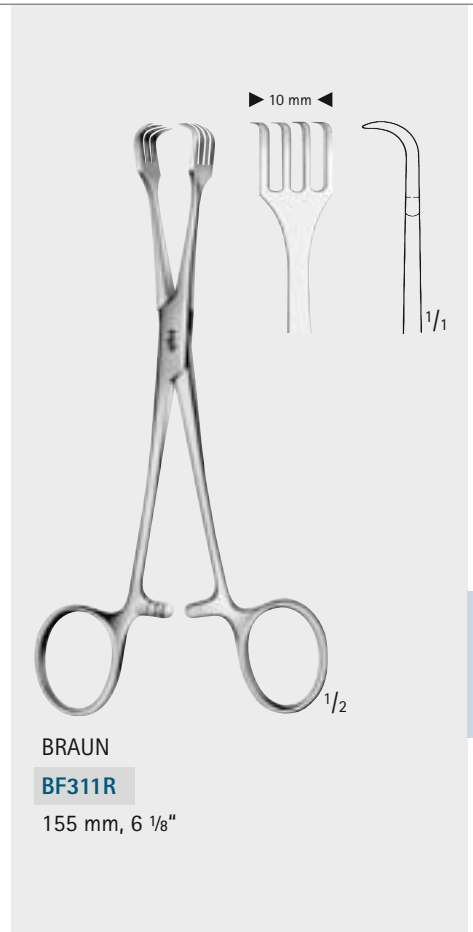
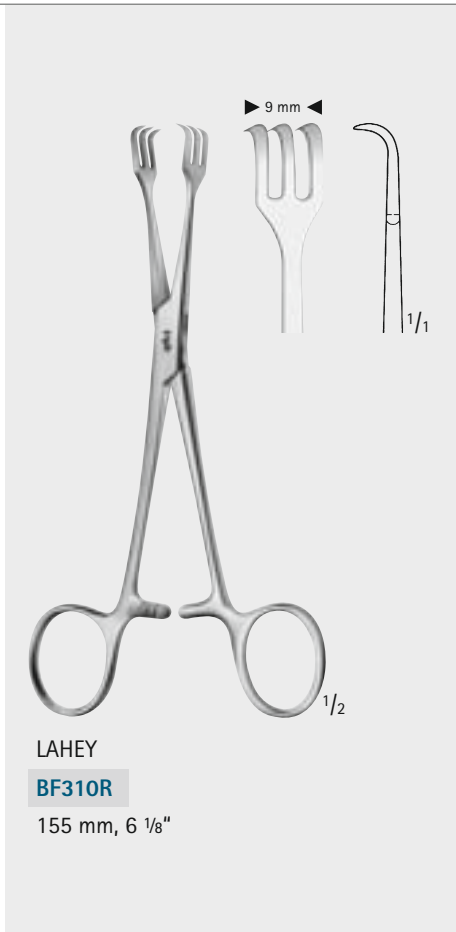
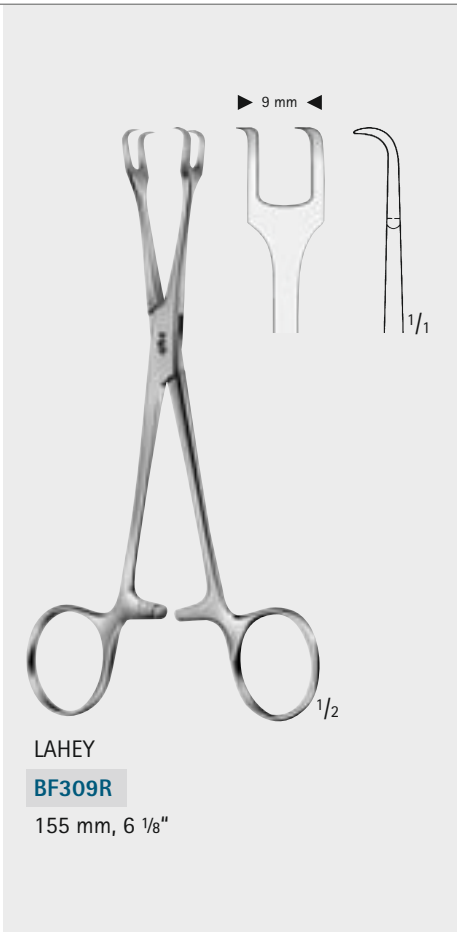

Adenotomie
Adenotomie

Adenoidectomy, Tonsillectomy – Adenotomie, Tonsillektomie

Tonsil Grasping Forceps

Tonsillenfasszangen



Adenotomy
Adenotomie



COLVER
OM611R
200 mm, 7 7/8"



WHITE
OM612R
180 mm, 7"



WHITE
OM613R
235 mm, 9 1/4"

Adenoidectomy, Tonsillectomy – Adenotomie, Tonsillektomie

Tonsil Grasping Forceps

Tonsillenfasszangen

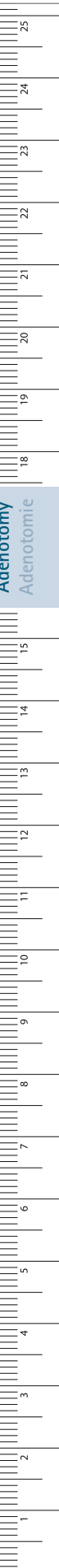
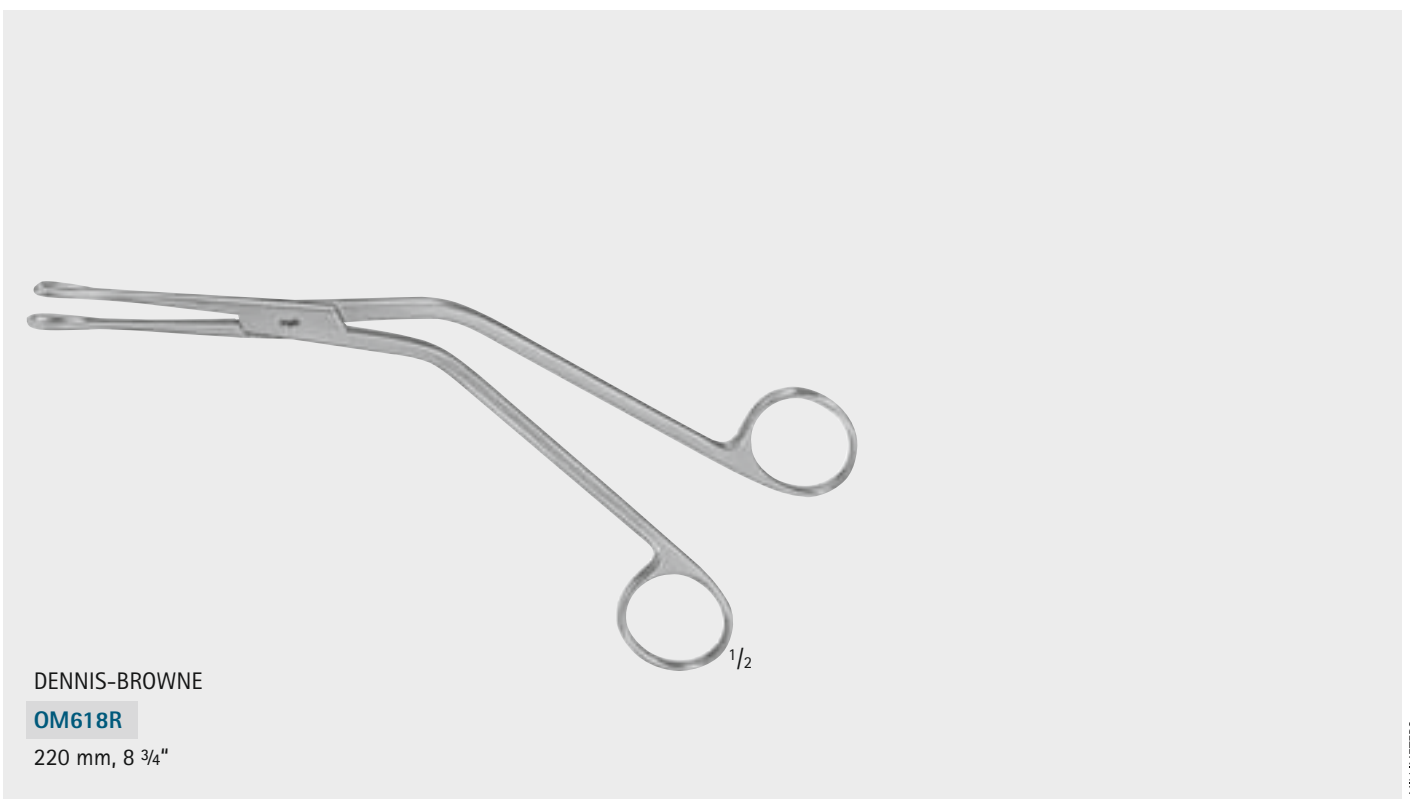
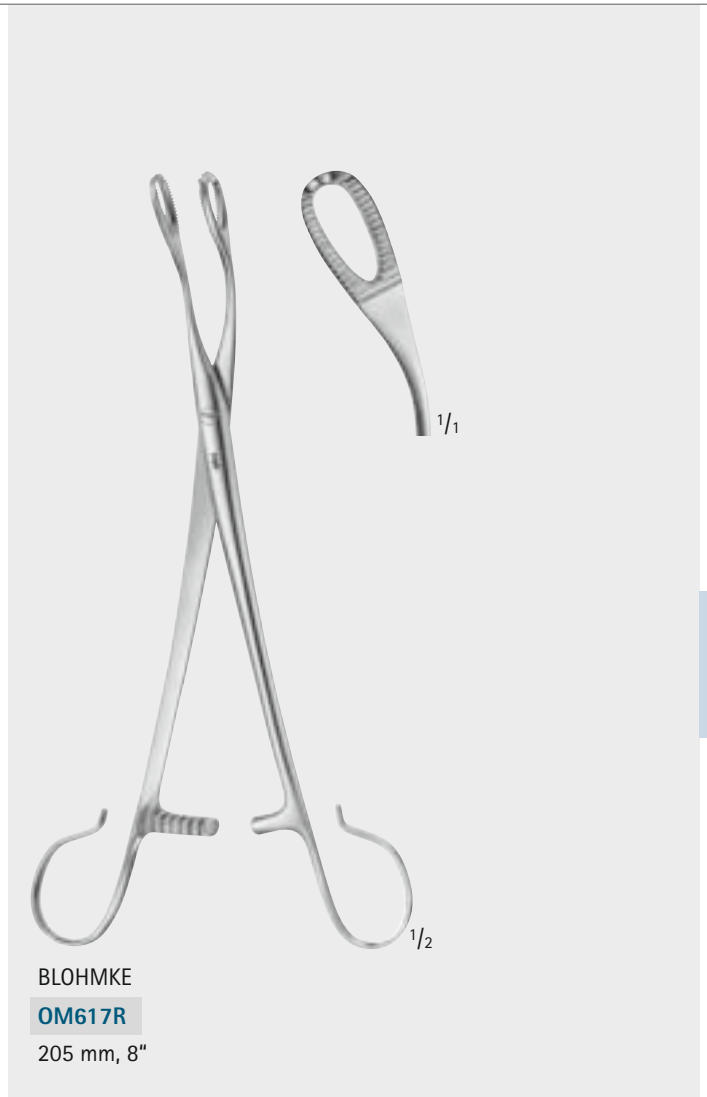
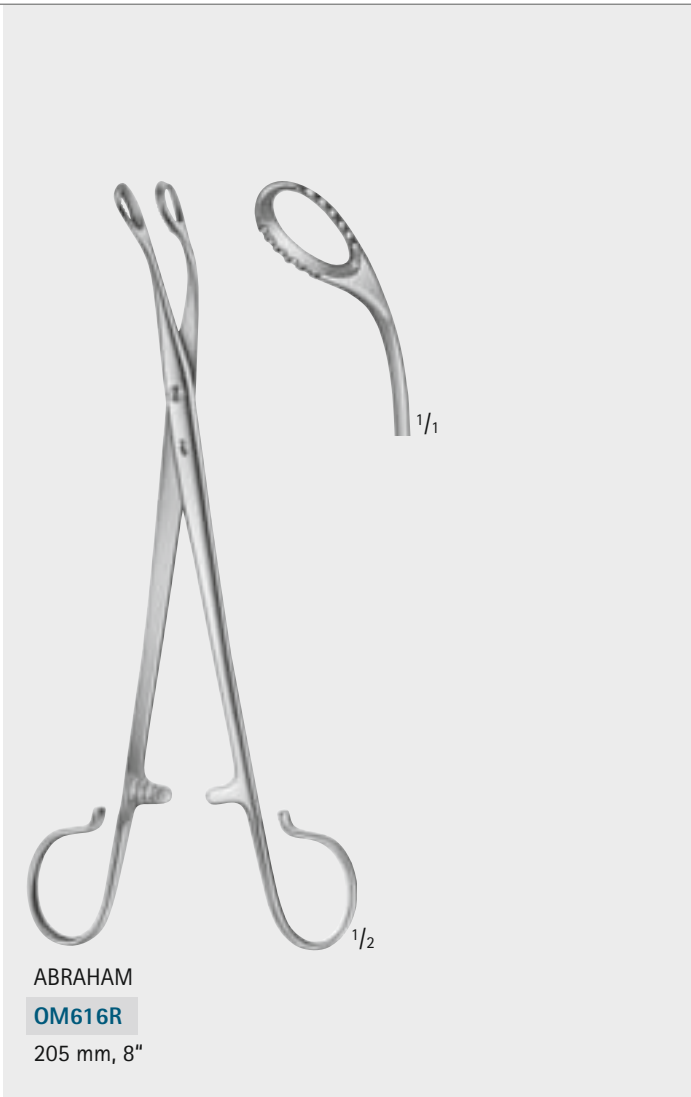

Adenoidectomy, Tonsillectomy – Adenotomie, Tonsillektomie

Tonsil Dissectors and Pillar Retractors

Tonsillendissektoren und -retraktoren



Adenotomy
Adenotomie

6 mm

1/1

1/2

1/1

HURD
OM660R
215 mm, 8 1/2"

10 mm

1/1

1/2

1/1

HURD
OM661R
215 mm, 8 1/2"

12 mm

1/1

1/2

1/1

HENKE
OM668R
235 mm, 9 1/4"

17 mm

1/1

1/2

1/2

HENKE
OM669R
235 mm, 9 1/4"

Adenoidectomy, Tonsillectomy – Adenotomie, Tonsillektomie

Tonsil Dissectors and Pillar Retractors

Tonsillendissektoren und -retraktoren



GWYNNE-EVANS

OM663R-OM664R

Tonsil dissector, double ended
Tonsillendissektor, doppelendig
200 mm, 7 7/8"

OM663R

OM664R



SYME

OM665R

Tonsil dissector,
blunt and sharp
Tonsillendissektor,
stumpf und scharf
185 mm, 7 1/4"



MOLLINSON

OM666R

Tonsil dissector and pillar retractor,
semi-sharp
Tonsillendissektor und -retraktor,
halb-scharf
185 mm, 7 1/4"

Adenotomie
Adenotomie

MILLIMETERS

- Please find suction cannulas in chapter suction instruments, starting on page 527
- Saugkanülen, siehe Kapitel Sauger, ab Seite 527

Adenoidectomy, Tonsillectomy – Adenotomie, Tonsillektomie

Sickle Knife, Tonsil Knife, Tonsil Retractor

Sichelmesser, Tonsillmesser, Tonsillenretraktor



Adenotomy
Adenotomie



OF601R

Sickle knife, sharp tip
Sichelmesser, spitz
190 mm, 7 1/2"



FOWLER

OM680R

Tonsil knife
Tonsillmesser
200 mm, 7 7/8"



ABRAHAM

OM681R

Tonsil knife
Tonsillmesser
220 mm, 8 3/4"



FISHER

OM688R

Tonsil knife
Tonsillmesser
205 mm, 8"



NAGER

OM637R

Tonsil retractor
Tonsillenretraktor
230 mm, 9"

Adenoidectomy, Tonsillectomy – Adenotomie, Tonsillektomie

Tonsil Scissors Tonsillenscheren

DEAN
OM700R
with angled serrated blades
aufgebogen, Schneiden fein
gezahnt
170 mm, 6 3/4"

BOETTCHER
OM707R
180 mm, 7"

GOOD
OM710R
195 mm, 7 3/4"

SCHWECKENDIEK
OM711R
195 mm, 7 3/4"

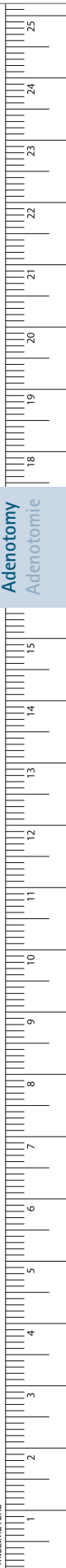

Adenotomie
Adenotomie

MILLIMETERS

Adenoidectomy, Tonsillectomy – Adenotomie, Tonsillektomie

Tonsil Snare, Single Use Tonsil Snare

Tonsillenschnürer, Einmal Tonsillenschnürer



Adenotomy
Adenotomie



EVES
OM760R
Tonsil snare complete with wire (25 swg)
Tonsillenschnürer, komplett mit Drahtschlinge
250 mm, 9 3/4"



EVES
OM761R
Tonsil snare with ratchet, complete with wire (25 swg)
Tonsillenschnürer mit Sperre, komplett mit Drahtschlinge
250 mm, 9 3/4"



BRÜNNINGS
OM768R
Tonsil snare
Tonsillenschnürer
270 mm, 10 5/8"



EVES
OM760SU
Single use tonsil snare, with two wire loops, sterile, pack with 20 pieces
Einmal Tonsillenschnürer, mit 2 Drahtschlingen, steril, Pack mit 20 Stück
285 mm, 11 1/4"

Adenoidectomy, Tonsillectomy – Adenotomie, Tonsillektomie

Snare Wires, Wire Loops

Schnürerdrähte, Drahtschlingen

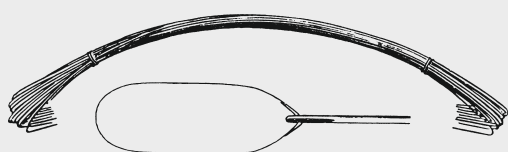

Art. No.	Diam. (mm)
Art. Nr.	Ø (mm)

OM750R 0.3

OM751R 0.5

Snare wires,
Sales unit: **PAK** = Package of 12 pieces
Schnürerdrähte,
Bestelleinheit: **PAK** = Packung à 12 Stück

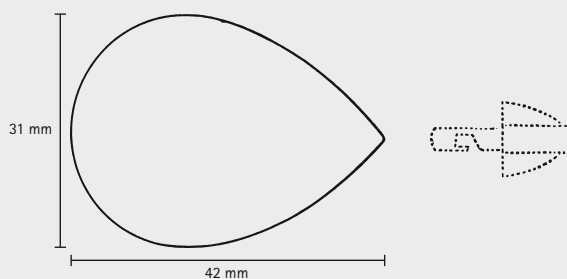

OM757R

Wire loops, diam 0.4 mm
Sales unit: **PAK** = Package of 100 pieces
Drahtschlingen, Ø 0,4 mm
Bestelleinheit: **PAK** = Packung à 100 Stück

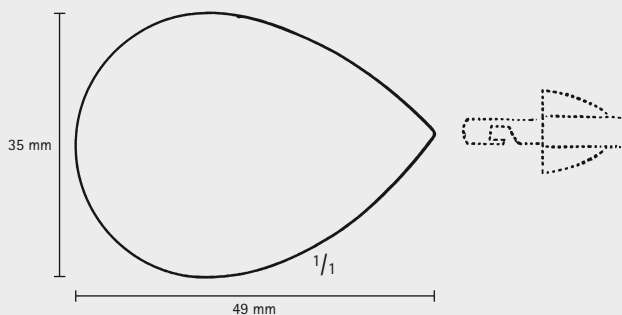

OM758R

Wire loops, diam. 0.4 mm
Sales unit: **PAK** = Package of 100 pieces
Drahtschlingen, Ø 0,4 mm
Bestelleinheit: **PAK** = Packung à 100 Stück

Adenotomie
Adenotomie

MILLIMETERS

Adenoidectomy, Tonsillectomy – Adenotomie, Tonsillektomie

Tonsil Snare, Tip, Ligature Instrument, Knot Tyer

Tonsillenschnürer, Aufsatz, Ligaturinstrument, Fadengabel

Adenotomy
Adenotomie

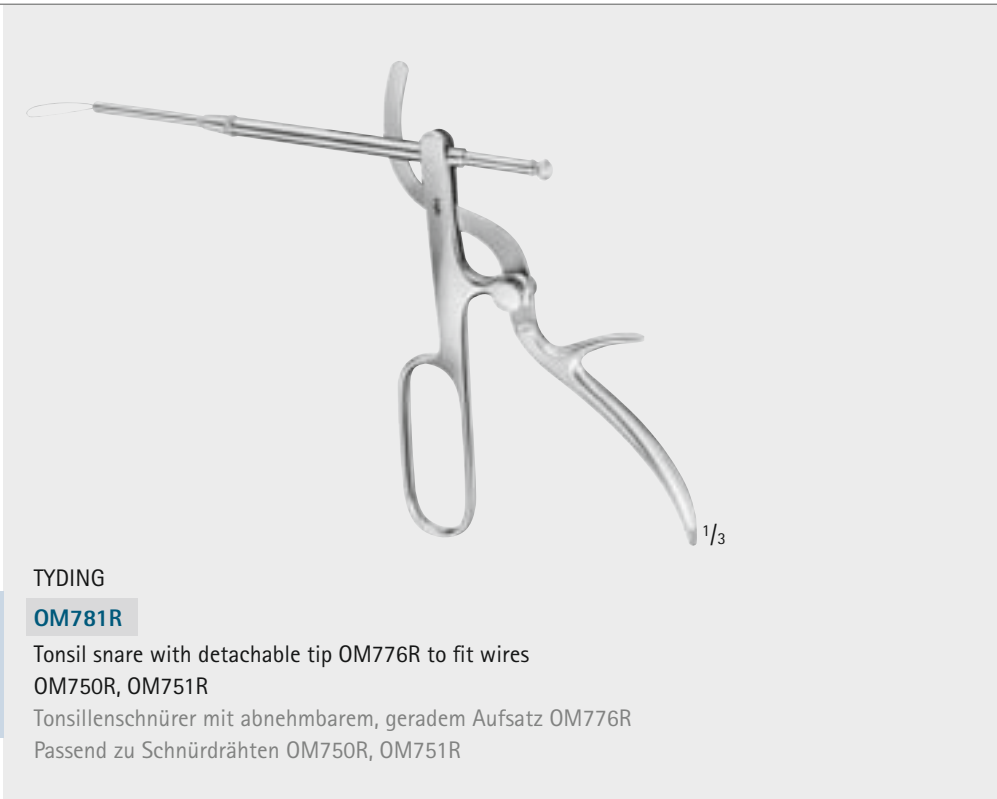

TYDING

OM781R

Tonsil snare with detachable tip OM776R to fit wires OM750R, OM751R

Tonsillenschnürer mit abnehmbarem, geradem Aufsatz OM776R
Passend zu Schnürdrähten OM750R, OM751R



1/2

TYDING

OM776R

Tip only, straight
gerader Aufsatz



ROEDER

OM915R

Ligature instrument, form E
Ligaturinstrument, Form E
260 mm, 10 1/4"

1/2



NEGUS

OM917R

Knot tyer
Fadengabel
205 mm, 8"

1/2

Adenoidectomy, Tonsillectomy – Adenotomie, Tonsillektomie

Blades for Tonsillotome Handle, Tonsillotome Handle, Tonsil Punches

Aufsätze für Tonsillotomgriff, Tonsillotomgriff, Tonsillenstanze

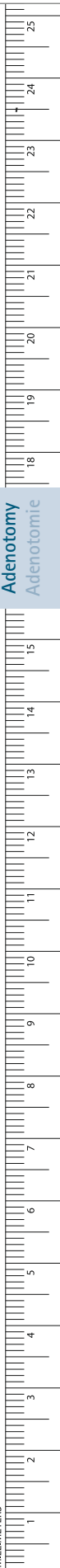
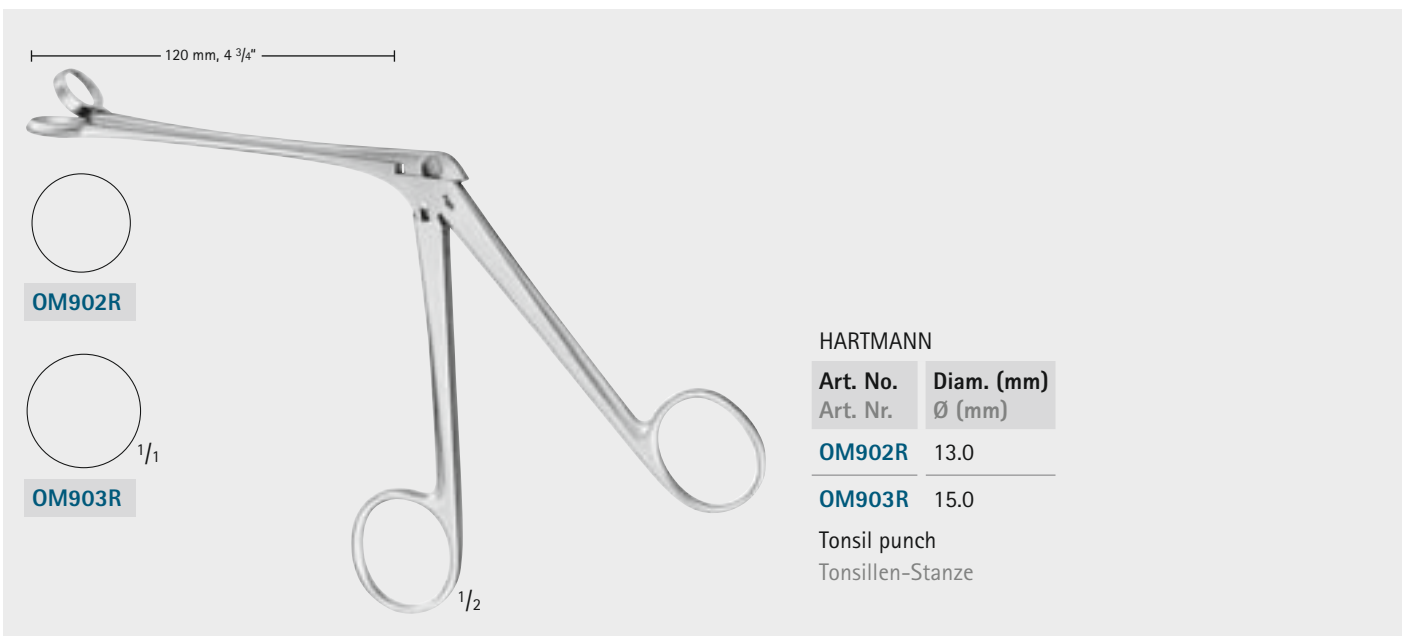
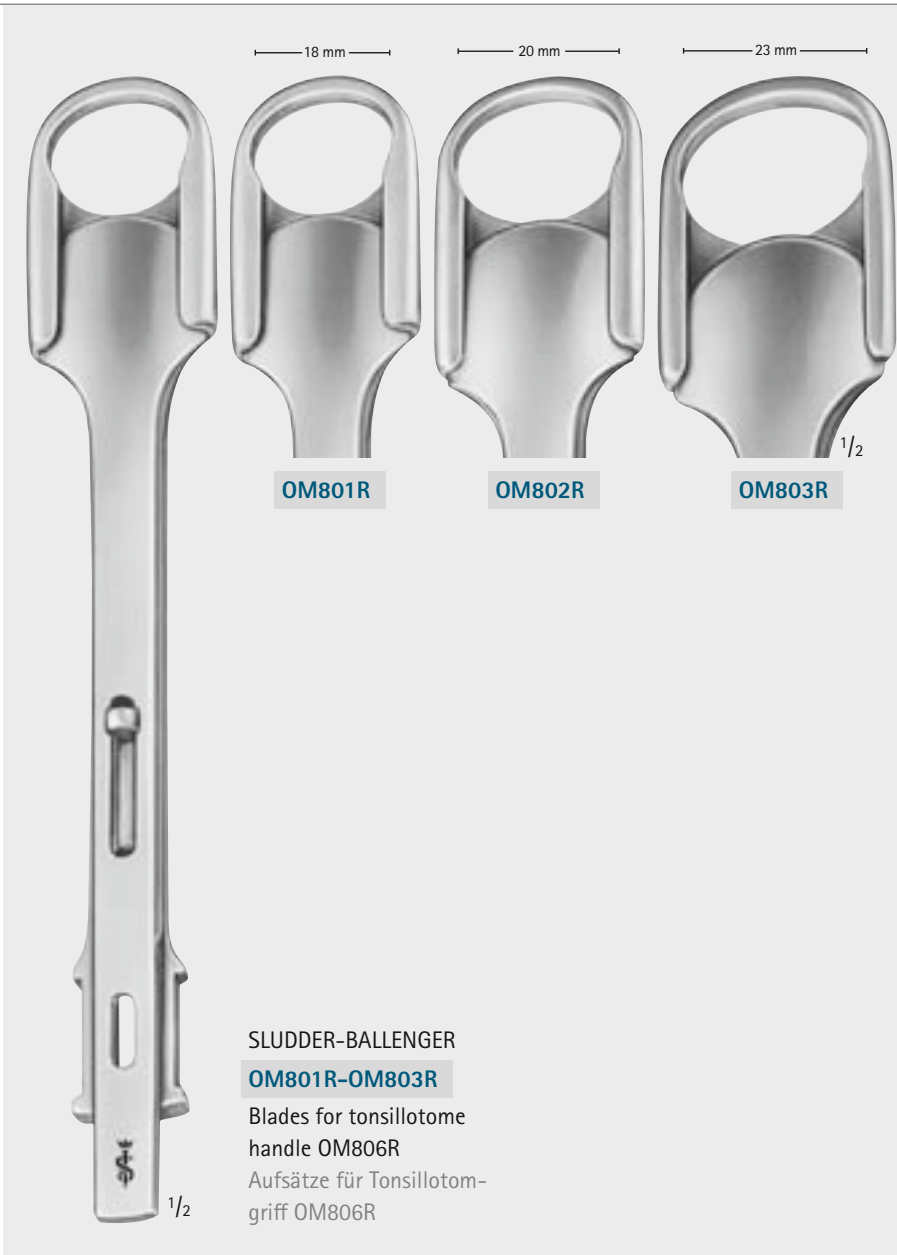

Adenoidectomy, Tonsillectomy - Adenotomie, Tonsillektomie

Adenoid Currettes

Ringmesser



Adenotomy
Adenotomie



1/2

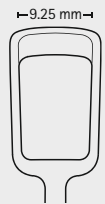

OM451R

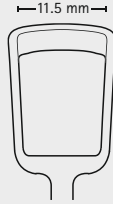

OM452R

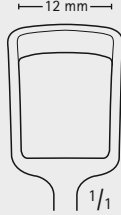

OM453R

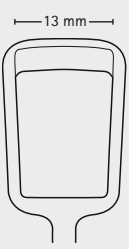

OM454R

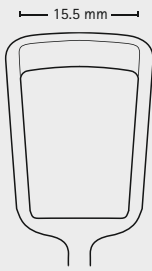

OM455R

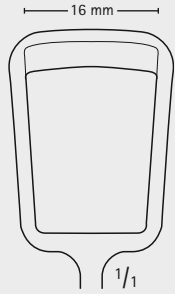

OM456R

BECKMANN

OM451R-OM456R

200 mm, 7 7/8"



1/2



OM500R



OM501R



OM502R



OM503R



OM504R

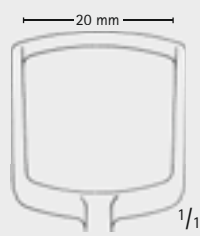

OM505R

BECKMANN

OM500R-OM505R





220 mm, 8 3/4"

Adenoidectomy, Tonsillectomy – Adenotomie, Tonsillektomie

Adenoid Curettes

Ringmesser

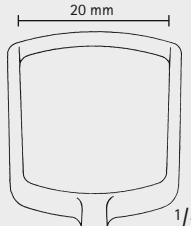

 <p>10 mm</p> <p>OM510R</p>	 <p>12.25 mm</p> <p>OM511R</p>	 <p>14 mm</p> <p>OM512R</p>
 <p>16.5 mm</p> <p>OM513R</p>	 <p>18 mm</p> <p>OM514R</p>	 <p>20 mm</p> <p>OM515R</p>

NEGUS
OM510R-OM515R
 reverse curve
 rückwärts gebogen
 200 mm, 7 7/8"

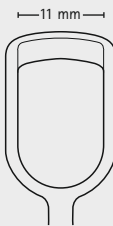
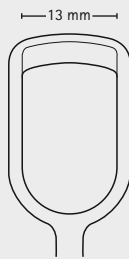
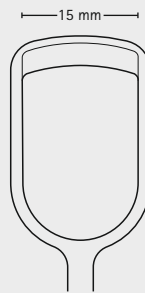
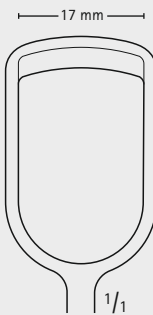

 <p>11 mm</p> <p>OM471R</p>	 <p>13 mm</p> <p>OM472R</p>	 <p>15 mm</p> <p>OM473R</p>	 <p>17 mm</p> <p>OM474R</p>
---	---	---	---

BARNHILL
OM471R-OM474R
 200 mm, 7 7/8"

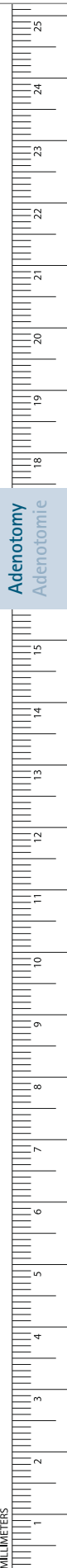

Adenoidectomy, Tonsillectomy – Adenotomie, Tonsillektomie

Adenoid Currettes

Ringmesser

Adenotomy
Adenotomie

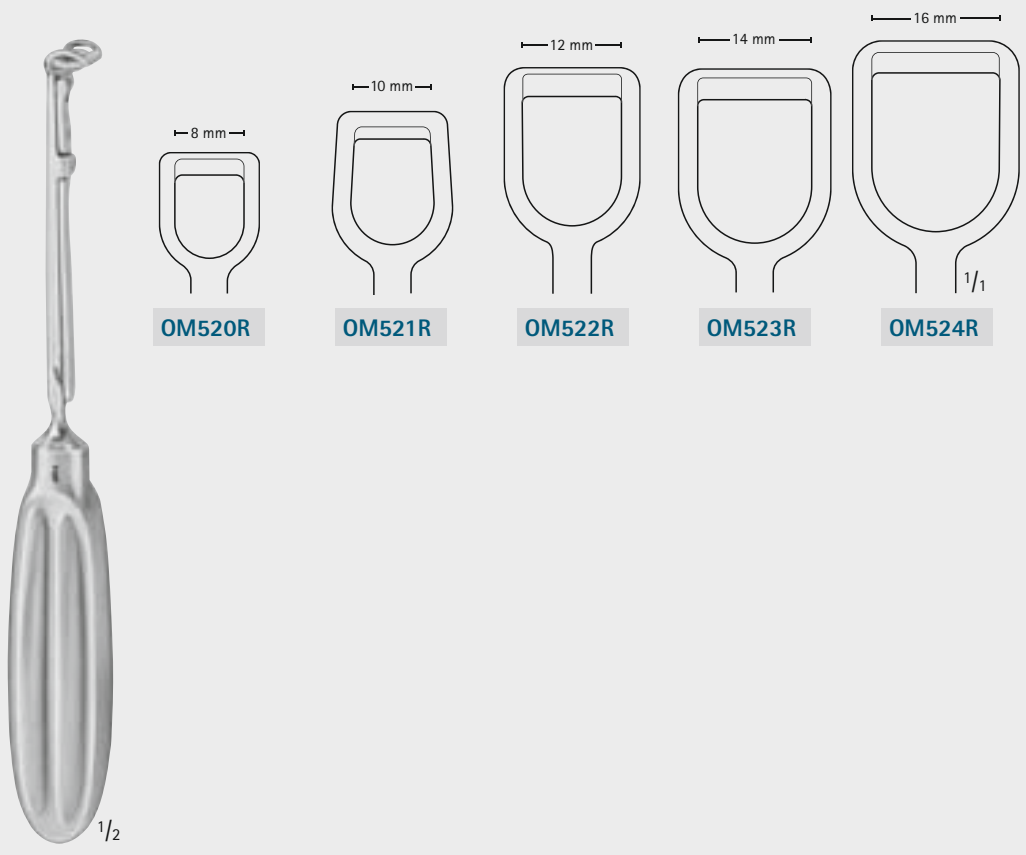

ST. CLAIR-THOMASON

OM520R-OM524R

with cage

mit Fangkorb

210 mm, 8 1/4"

Adenoidectomy, Tonsillectomy – Adenotomie, Tonsillektomie

Adenotomes, Spare Blades

Pharynx Tonsillotom, Ersatzklingen



OM391R

1/2



OM392R

1/2



OM393R

1/2

LA FORCE

OM391R-OM393R

Adenotomes

Pharynx tonsillotom

235 mm, 9 1/4"

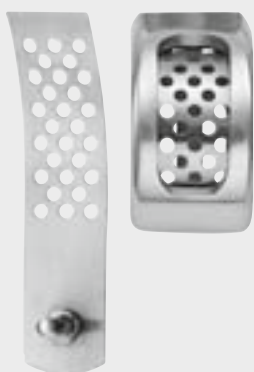

OM396R



OM397R



OM398R

LA FORCE

OM396R-OM398R

Spare blades only, perforated
suitable for OM391R-OM393R

Ersatzklingen, allein, gelocht,
passend für OM391R-OM393R

Adenotomie
Adenotomie

MILLIMETERS

Adenoidectomy, Tonsillectomy – Adenotomie, Tonsillektomie

Nasopharynx Forceps, Adenoid Cutting Forceps

Nasenrachenzangen

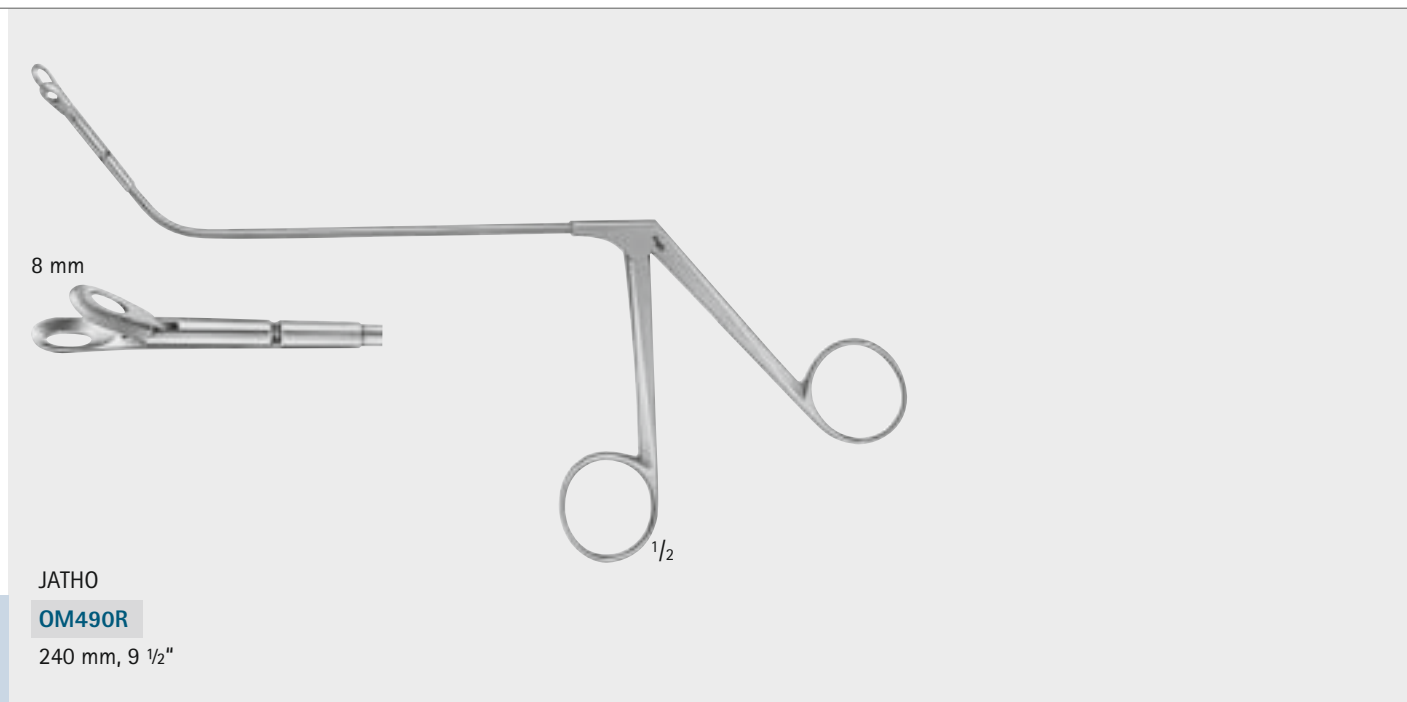

JATHO
OM490R
 240 mm, 9 1/2"



JURASZ
OM496R
 for children
 für Kinder
 190 mm, 7 1/2"

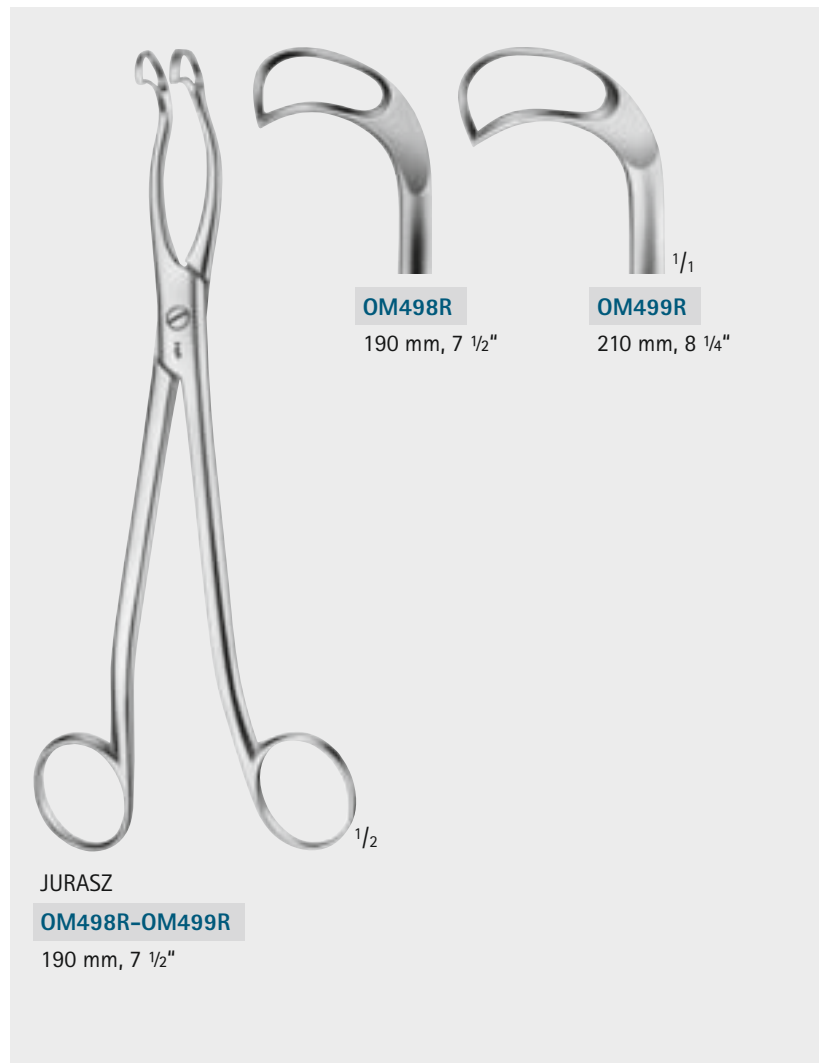

OM498R
 190 mm, 7 1/2"

OM499R
 210 mm, 8 1/4"

JURASZ
OM498R-OM499R
 190 mm, 7 1/2"

- Please find further forceps and conchotomes in chapter Rhinology, FESS, Rhinoplasty, starting on page 70
- Weitere Zangen und Conchotome siehe Kapitel Rhinologie, FESS und Septum- und Nasenplastik, ab Seite 70

Laryngology
Laryngologie







Laryngology - Laryngologie

Laryngeal Mirrors and Handles

Kehlkopfspiegel und -Griffe

- OM078R-OM090R: with handle / mit Griff
- AC468R-AC480R: without handle / ohne Griff

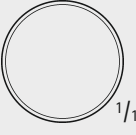
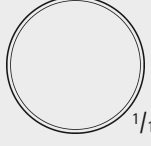
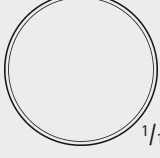
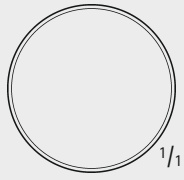
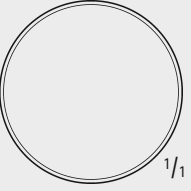
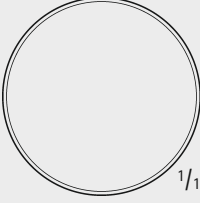
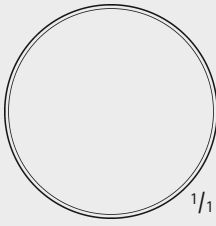
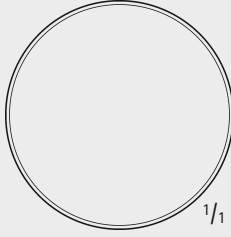
 OM078R/ AC468R Fig. 000 Diam. 6 mm Ø 6 mm	 OM079R/ AC469R Fig. 00 Diam. 8 mm Ø 8 mm	 OM080R/ AC470R Fig. 0 Diam. 10 mm Ø 10 mm	 OM081R/ AC471R Fig. 1 Diam. 12 mm Ø 12 mm	 OM082R/ AC472R Fig. 2 Diam. 14 mm Ø 14 mm	 OM083R/ AC473R Fig. 3 Diam. 16 mm Ø 16 mm	 OM084R/ AC474R Fig. 4 Diam. 18 mm Ø 18 mm	 OM085R/ AC475R Fig. 5 Diam. 20 mm Ø 20 mm
 OM086R/ AC476R Fig. 6 Diam. 22 mm Ø 22 mm	 OM087R/ AC477R Fig. 7 Diam. 24 mm Ø 24 mm	 OM088R/ AC478R Fig. 8 Diam. 26 mm Ø 26 mm	 OM089R/ AC479R Fig. 9 Diam. 28 mm Ø 28 mm	 OM090R/ AC480R Fig. 10 Diam. 30 mm Ø 30 mm			

OM078R-OM090R
Laryngeal mirrors
with hexagonal handle
Kehlkopfspiegel
mit Sechskantgriff
180 mm, 7"

AC468R-AC480R
Laryngeal mirrors
Kehlkopfspiegel
120 mm, 4 3/4"

AC481R
Mirror handle
Spiegelgriff
110 mm, 4 1/4"

AC483C
Mirror handle
Spiegelgriff
105 mm, 4 1/8"

Laryngology - Laryngologie

Operation Laryngoscopes, Chest Support and Laryngoscope Holder

Operations-Laryngoskope, Bruststütze und Laryngoskophalter



OP280R, OP292R-OP295R

Operating laryngoscopes
Operations-Laryngoskope



OP281R-OP282R

Operating laryngoscopes
Operations-Laryngoskope

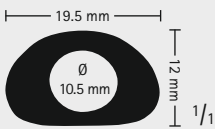

OP280R

for children, small size
für Kinder, klein
130 mm, 5 1/8"

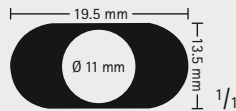

OP295R

for children
für Kinder
130 mm, 5 1/8"

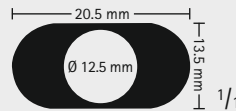

OP294R

for adolescents, small size
für Jugendliche, klein
180 mm, 7"

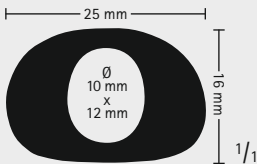

OP281R

for adults, medium size
für Erwachsene, mittel
180 mm, 7"

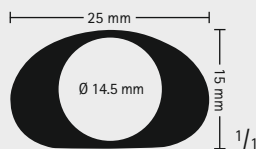

OP293R

for adults, medium size
für Erwachsene, mittel
180 mm, 7"

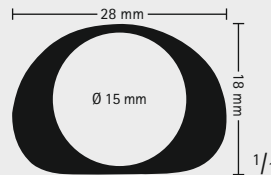

OP292R

for adults, large size
für Erwachsene, groß
180 mm, 7"

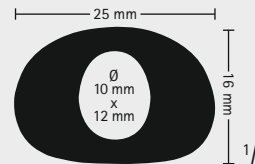

OP282R

for adults, medium size for long neck
für Erwachsene, mittel für langen Hals
220 mm, 8 3/4"

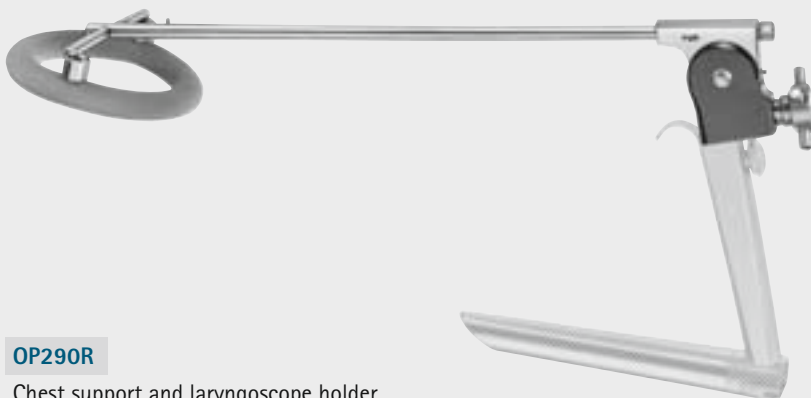

OP290R

Chest support and laryngoscope holder,
for adults and children
Bruststütze und Laryngoskophalter,
für Erwachsene und Kinder

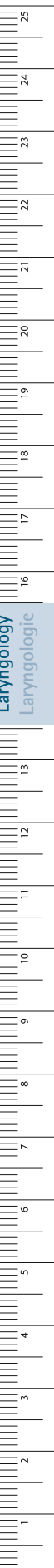

Laryngologie
Laryngologie

MILLIMETERS

Laryngology – Laryngologie

Light Guides, Teeth Protector

Lichtleiter, Zahnschutz



OP297R

Light guide for use with laryngoscopes OP281R–OP294R and Aesculap light guide cables.

Suitable Aesculap light guide cable OP913, 2.5 m long.

Lichtleiter für Laryngoskop OP281R–OP294R und Anschluss an Aesculap Lichtleitkabel.

Passendes Aesculap Lichtleitkabel OP913, 2,5 m lang.

- For further light guide cables and light sources see Aesculap brochure C46702.
- Weitere Lichtleitkabel und Lichtquellen finden Sie im Aesculap Prospekt C46701.



OP298R

Light guide for use with laryngoscope OP280R, OP295R and Aesculap light guide cables.

Lichtleiter für Laryngoskop OP280R, OP295R und Anschluss an Aesculap Lichtleitkabel.



OP299

Teeth protector

Zahnschutz

Laryngology - Laryngologie

Micro Laryngeal Grasping Forceps, Cartilage Forceps

Mikro-Laryngoskopie Fasszängchen, Korpelfasszange

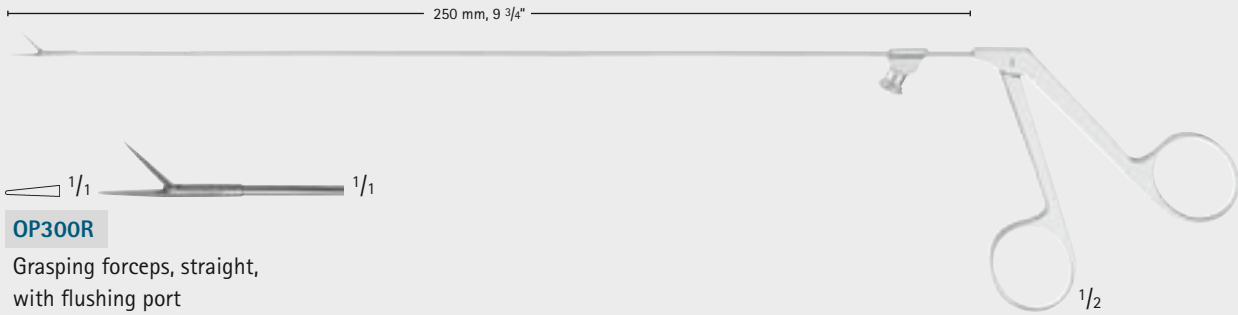

OP300R

Grasping forceps, straight,
with flushing port
Fasszängchen, gerade,
mit Spülanschluss

OP300R-OP302R

Tubular shaft forceps
for endolaryngeal microsurgery
Rohrschaftzängchen
für die endolaryngoskopische
Mikro-Chirurgie



OP301R

Grasping forceps, left curved
with flushing port
Fasszängchen, links gebogen,
mit Spülanschluss



OP302R

Grasping forceps, right curved,
with flushing port
Fasszängchen, rechts gebogen
mit Spülanschluss

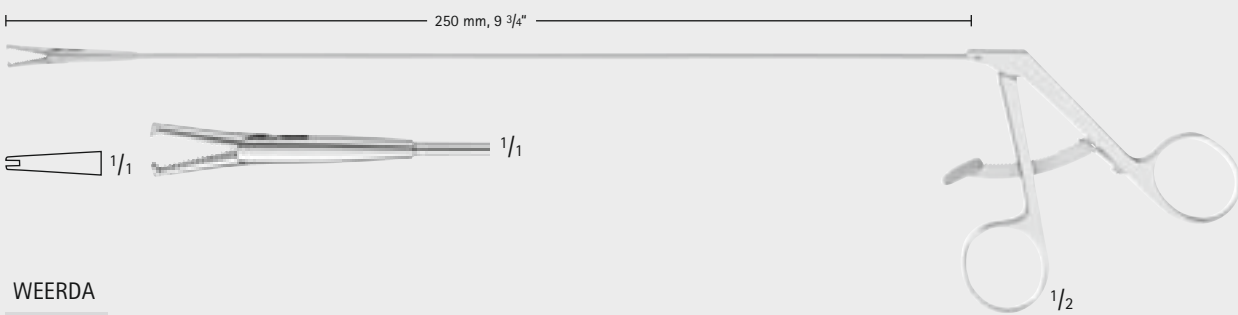

WEERDA

OP401R

Cartilage forceps,
with ratchet
Knorpelfasszange,
mit Sperre

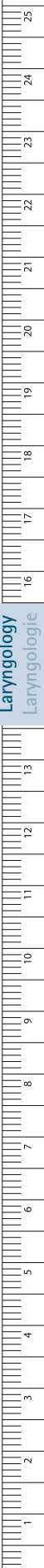

Laryngology
Laryngologie

MILLIMETERS

Laryngology - Laryngologie

Micro Laryngeal Cup Forceps

Mikro-Laryngoskopie-Löffelzängchen

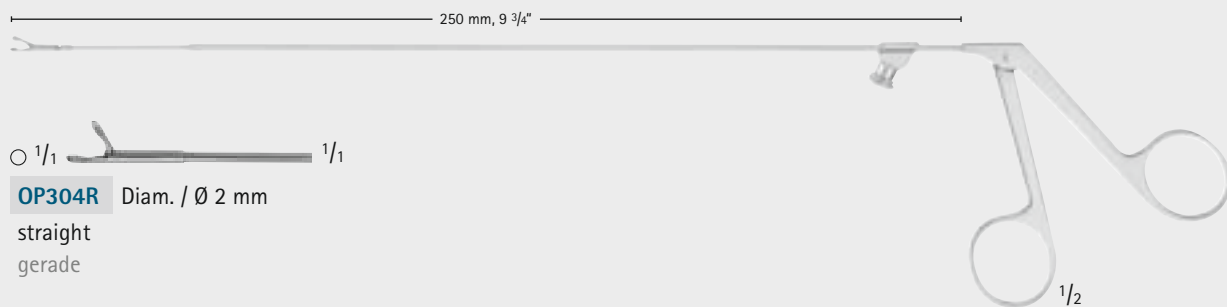

OP304R Diam. / Ø 2 mm
straight
gerade

OP304R-OP307R
Cup forceps,
with flushing port
Löffelzängchen,
mit Spülanschluss

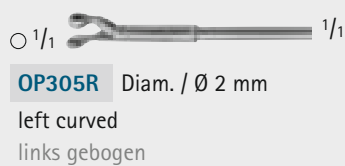

OP305R Diam. / Ø 2 mm
left curved
links gebogen

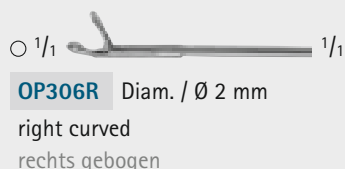

OP306R Diam. / Ø 2 mm
right curved
rechts gebogen

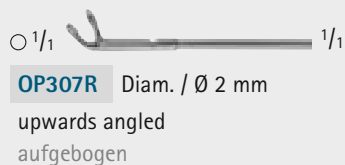

OP307R Diam. / Ø 2 mm
upwards angled
aufgebogen



OP419R
Cup forceps,
with flushing port
Löffelzängchen,
mit Spülanschluss

Laryngology - Laryngologie

Micro Laryngeal Scissors, Micro Laryngeal Forceps

Mikro-Laryngoskopie-Scherchen, Mikro-Laryngoskopie-Zängchen



OP310R

straight
gerade

OP310R-OP313R

Scissors,
with flushing port
Scherchen,
mit Spülanschluss



OP311R

left curved
links gebogen



OP312R

right curved
rechts gebogen



OP313R

upwards angled
aufgebogen

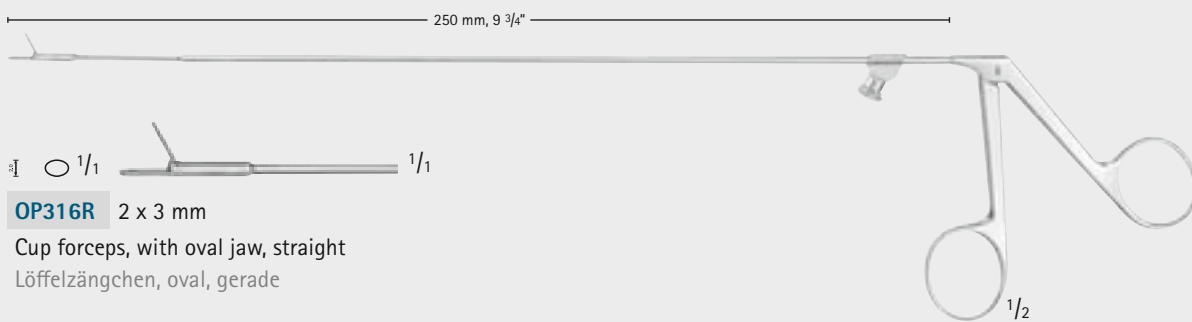

OP316R 2 x 3 mm

Cup forceps, with oval jaw, straight
Löffelzängchen, oval, gerade

OP316R-OP325R

with flushing port
mit Spülanschluss



OP320R 10 x 4.6 mm

Cup forceps, with fenestrated jaw, straight
Löffelzängchen, gefenstert, gerade



OP325R

Biopsy forceps, 90° angled
Zängchen zur Probeexzision, 90° abgewinkelt

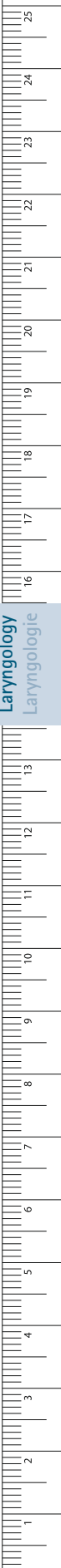

MILLIMETERS

Laryngology - Laryngologie

Micro Laryngeal Cup Forceps, Micro Laryngeal Grasping Forceps

Mikro-Laryngologie-Löffelzängchen, Mikro-Laryngologie-Fasszängchen



230 mm, 9"

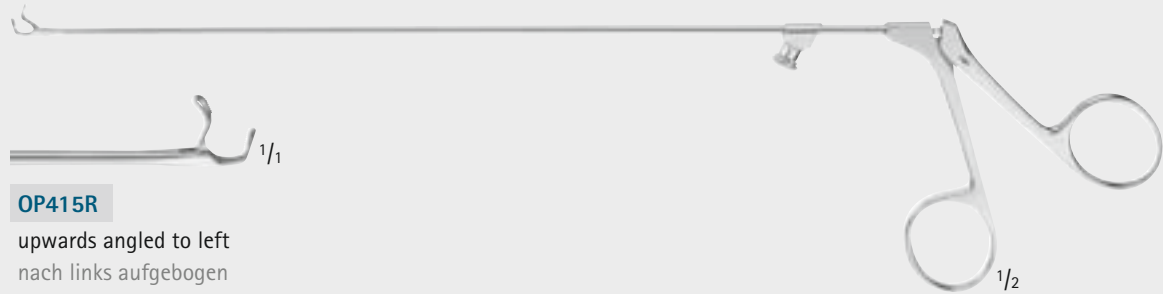

OP415R

upwards angled to left
nach links aufgebogen

OP415R-OP416R

Cup forceps,
with irrigation connection
Löffelzängchen,
mit Spülanschluss



OP416R

upwards angled to right
nach rechts aufgebogen

Laryngology
Laryngologie

230 mm, 9"

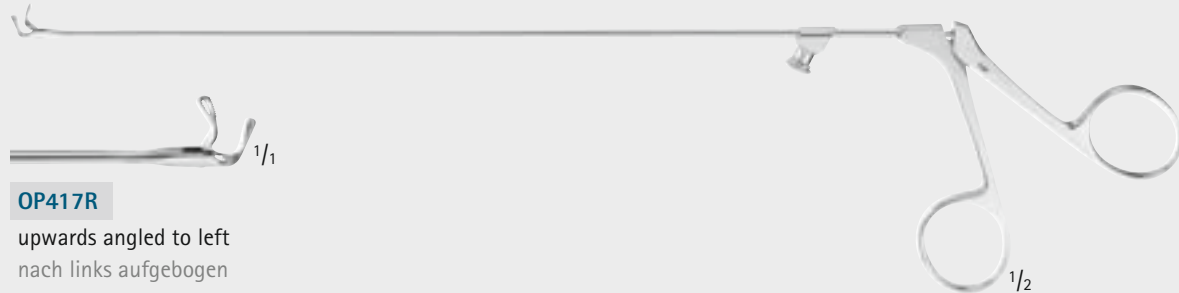

OP417R

upwards angled to left
nach links aufgebogen

OP417R-OP418R

Grasping forceps,
with irrigation connection
Fasszängchen,
mit Spülanschluss



OP418R

upwards angled to right
nach rechts aufgebogen

Laryngology - Laryngologie

Laryngeal Needle Holder

Kehlkopfnadelhalter

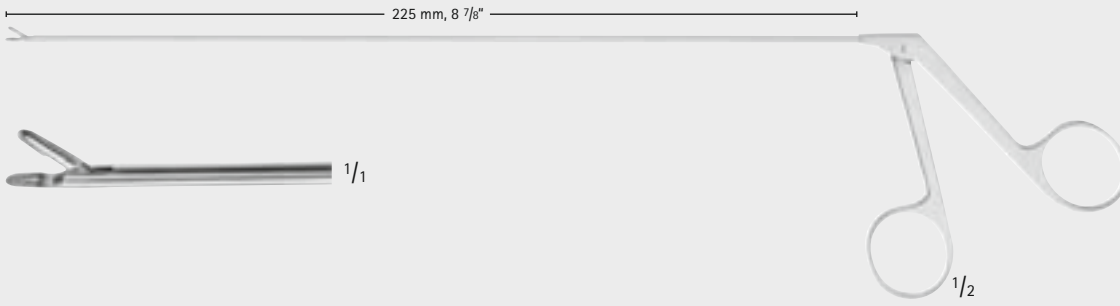

OP402R

Laryngeal needle holder
Kehlkopfnadelhalter

Laryngology
Laryngologie

MILLIMETERS

Laryngology - Laryngologie

Micro Laryngeal Instruments

Mikro-Laryngoskopie Instrumente

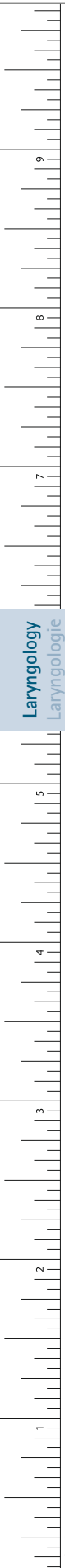

OP386R
Sickle knife
Sichelmesser



OP403R
Knife,
straight cut
Messers,
gerader Schnitt



OP387R
Separator,
oval blade, horizontal
Schäl-Messer,
quer, oval



OP388R
Separator,
oval blade, vertical
Schäl-Messer,
längs, oval



OP405R
Separator,
oval, curved
Schäl-Messer,
oval, gebogen



OP389R Diam. / Ø 3.5 mm
Round cutting knife,
45° angled
Schäl-Messer,
45° abgewinkelt



OP386R-OP409R
Laryngeal instruments
for use with handle
OP380R
Laryngoskopie-
Instrumente
für Handgriff OP380R



OP390R
Hook,
90° angled, blunt
Häkchen,
90° gebogen, stumpf



OP406R
Hook, sharp
Häkchen, scharf



OP392R
Hook,
backwards curved
Häkchen,
retrograd gebogen



OP409R
Hook,
90° angled, blunt
Häkchen,
90° gewinkelt, stumpf



OP396R
Suture guide,
fork-shaped
Fadengabel



OP407R
Ligature needle,
right curved
Unterbindungsnadel,
rechts gebogen



OP408R
Ligature needle,
left curved
Unterbindungsnadel,
links gebogen

Laryngology – Laryngologie

Micro Laryngeal Instruments

Mikro-Laryngoskopie Instrumente



OP380R

Handle for use
with laryngeal instruments OP386R-OP409R
Handgriff für
Laryngoskopie-Instrumente OP386R-OP409R

- Laryngeal instruments with handle OP380R
- Laryngoskopie-Instrumente mit Handgriff OP380R

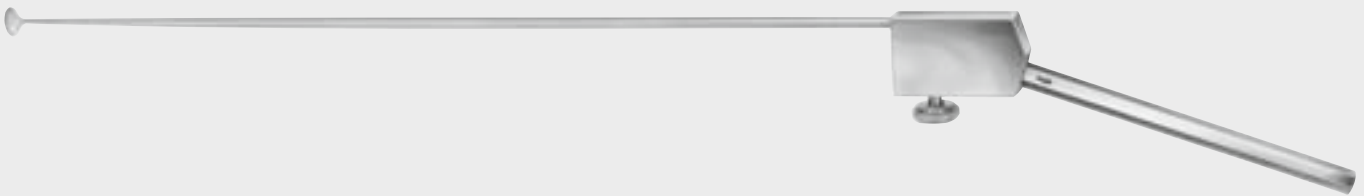

Laryngology
Laryngologie

MILLIMETERS

Laryngology – Laryngologie

Laryngeal Polypus Forceps

Kehlkopfpolypenzangen



Laryngology
Laryngologie

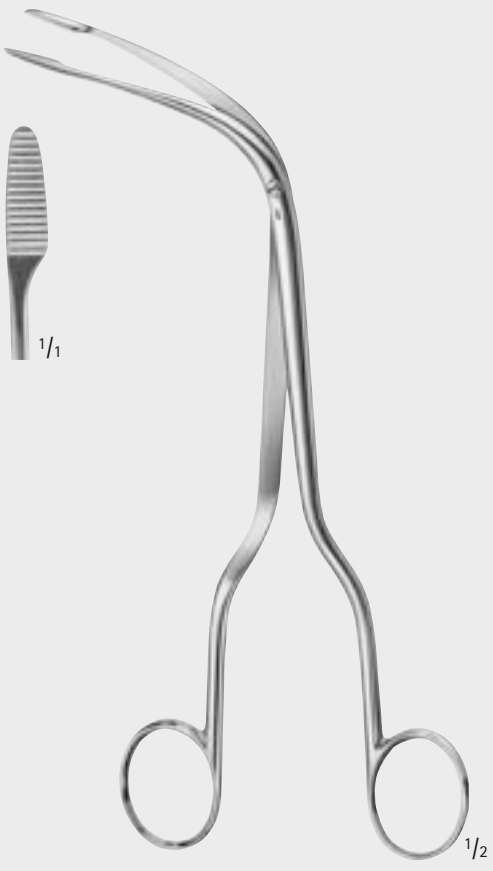

FRAENKEL
OP100R
220 mm, 8 3/4"

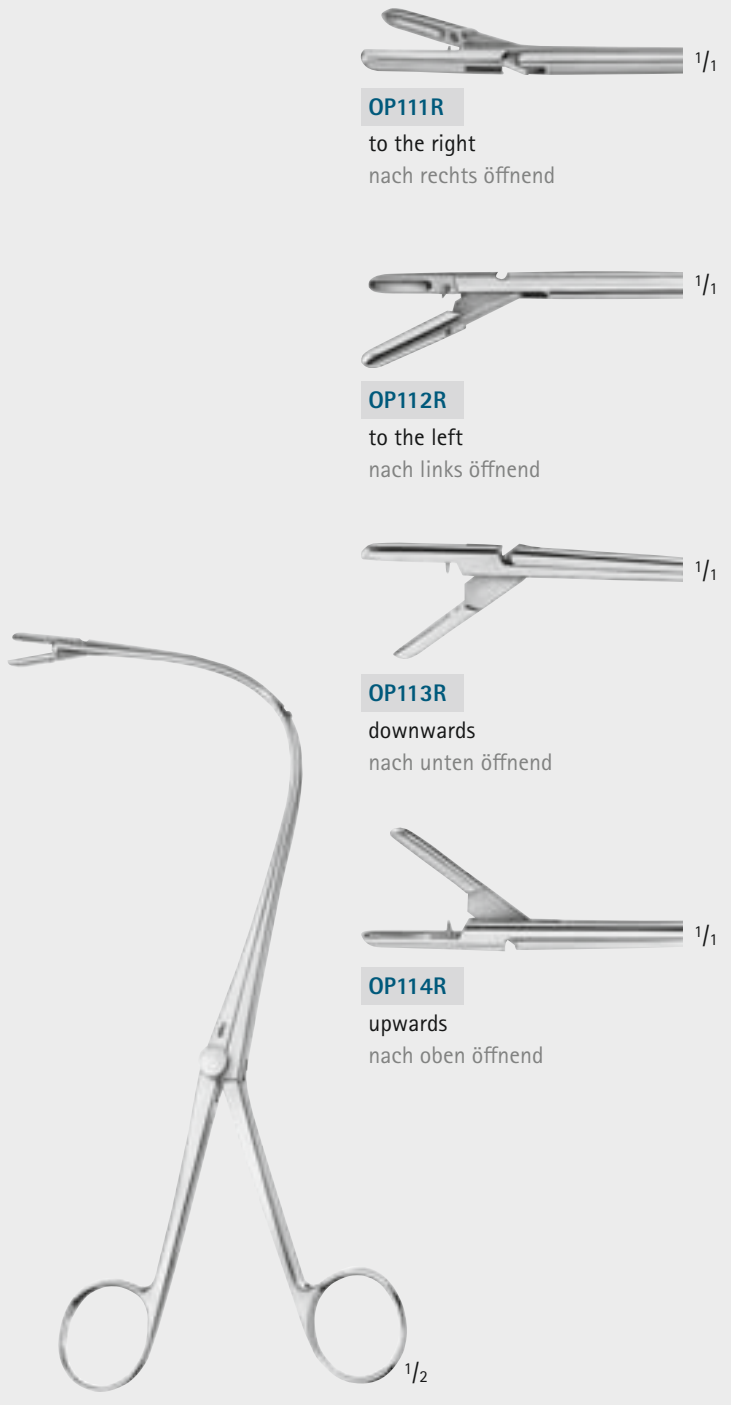

OP111R
to the right
nach rechts öffnend

OP112R
to the left
nach links öffnend

OP113R
downwards
nach unten öffnend

OP114R
upwards
nach oben öffnend

JURASZ
OP111R-OP114R
210 mm, 8 1/4"

Laryngology - Laryngologie

Laryngeal Forceps, Laryngectomy Scissors
 Kehlkopfzangen, Laryngofissurscheren

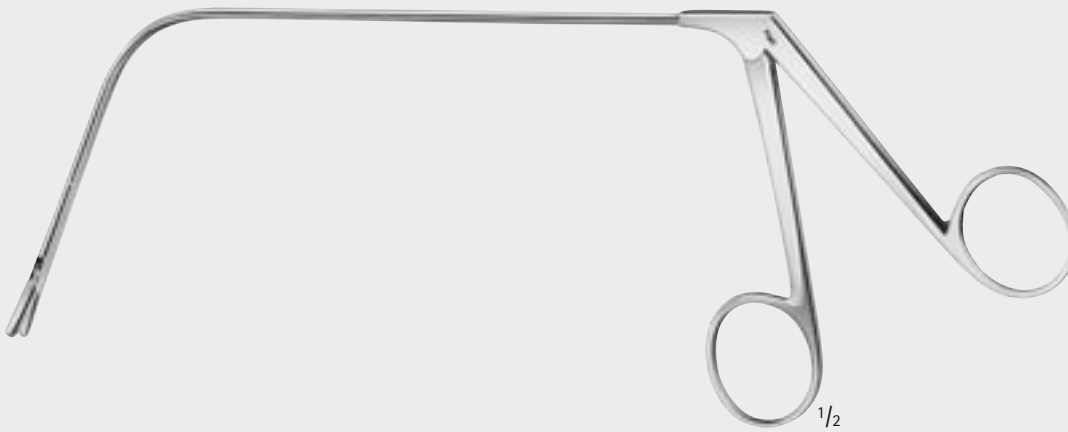

FRAENKEL

OP120R

Laryngeal forceps,
 both sides opening, oval
 Kehlkopfzange,
 doppelseitig öffnend, längs oval

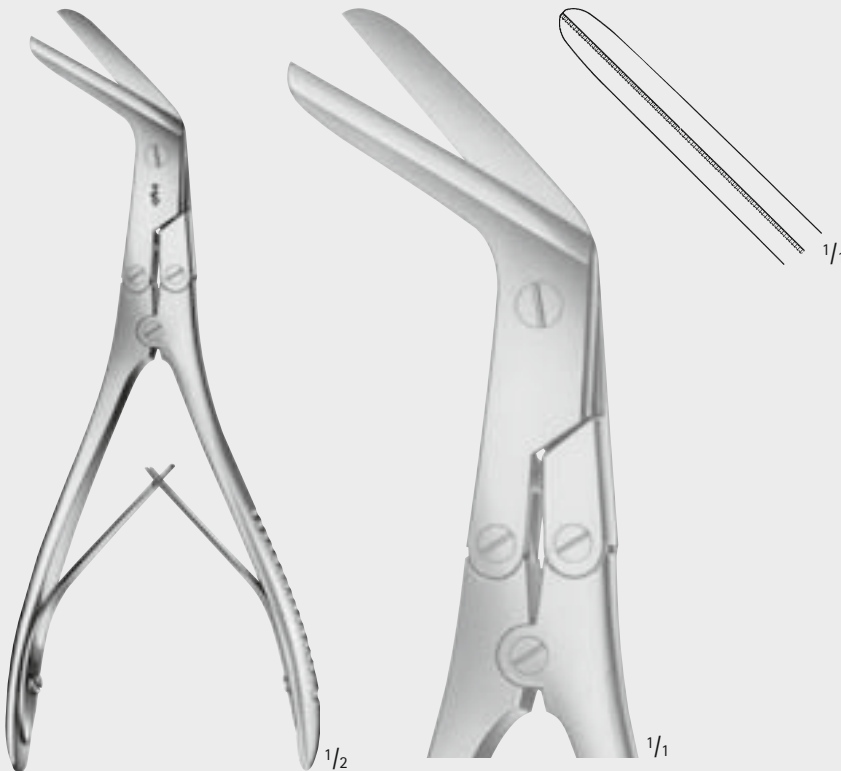

KILLIAN

OP130R

Laryngectomy scissors,
 double action
 Laryngofissurschere,
 doppelt übersetzt
 200 mm, 7 7/8"

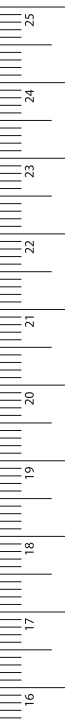

Laryngology
 Laryngologie

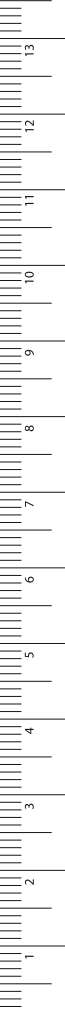

MILLIMETERS

Laryngology - Laryngologie

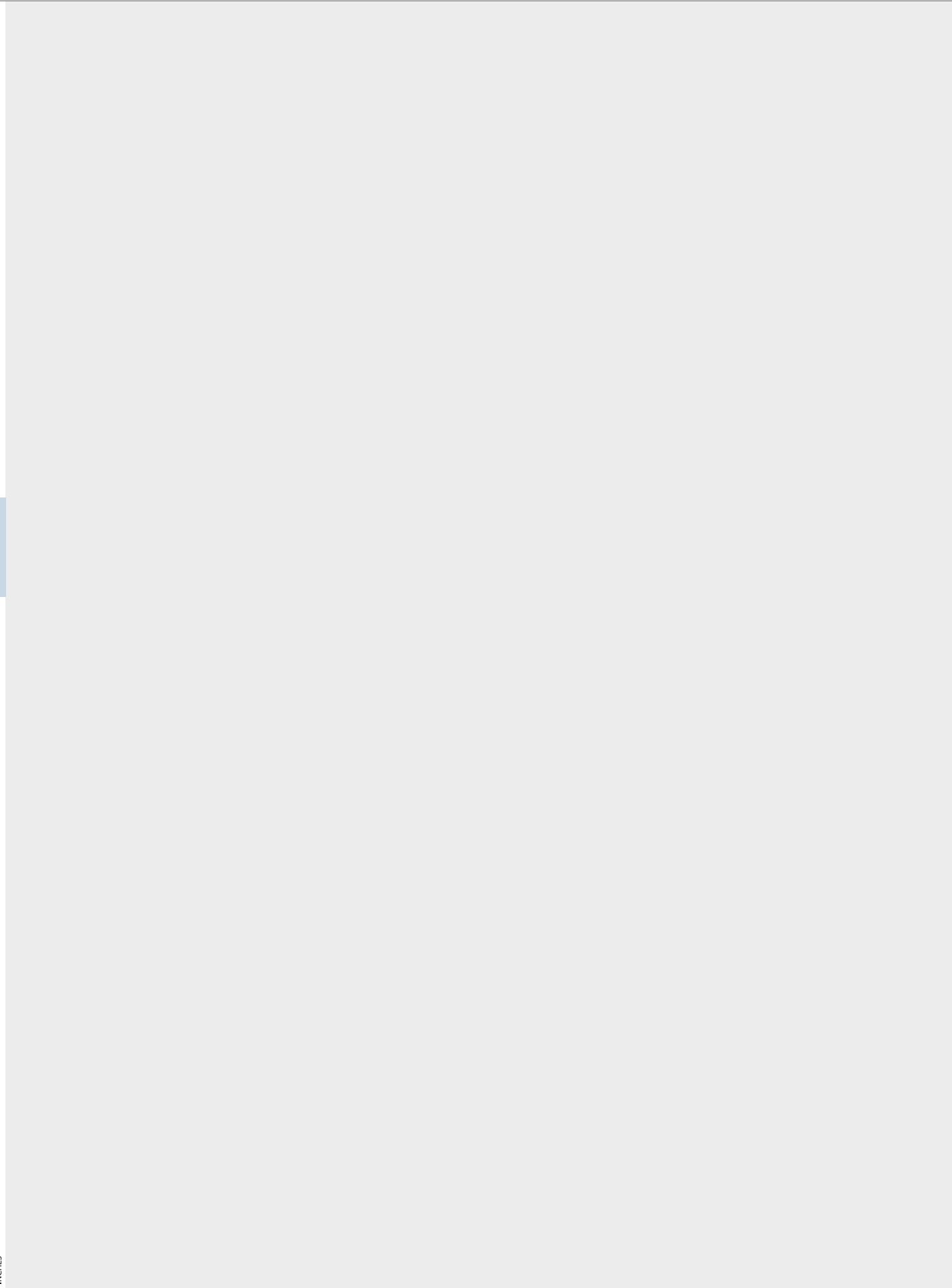

Micro Vascular Surgery
Mikro-Gefäßchirurgie



Micro Vascular Surgery – Mikro-Gefäßchirurgie

Titanium Micro Instruments

Titanium Mikro-Instrumente



Exceptional grasping qualities: Aesculap® Dia Dust®

All needle holder and forcep jaws are coated with Aesculap® Dia Dust®. This coating ensures that the inner surfaces provide the best possible performance in hardness and wear resistance. The texture of the jaws greatly increases its surface area, allowing you to grasp fine needles, sutures and soft tissue safely and securely. The needle quickly aligns itself in an ideal position in the rough surface. This results in a perfect grip that quite simply prevents any needle slippage.

Außergewöhnlicher Grip: Aesculap® Dia Dust®

Im Arbeitsende sind alle Nadelhalter und Pinzetten mit Aesculap® Dia Dust® beschichtet. Diese Beschichtung bringt für die Maulinnenflächen beste Ergebnisse in Härte und Verschleißfestigkeit. Die ungleichmäßige Oberflächenbeschaffenheit führt zu einer starken Oberflächenvergrößerung. Damit können Sie feine Nadeln, Nahtmaterialien und Weichgewebe sicher fassen. Zudem findet die Nadel in der rauen Oberfläche schnell ihre ideale Position. Dies führt zu einem perfektem Grip, der ein Wegrutschen oder Kippen der Nadel ganz einfach verhindert.



Unmistakable identification: the Aesculap color code.

The unique color coding means that you automatically pick up the right instrument.

Unverwechselbare Kennzeichnung: Aesculap Color Code.

Mit der intelligenten Farbcodierung greifen Sie automatisch und sicher zum richtigen Instrument.

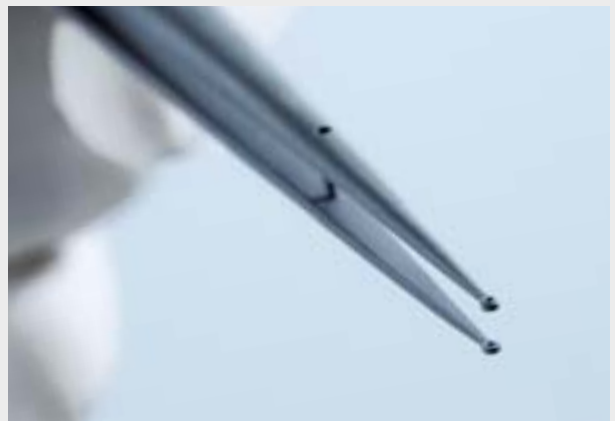

Non-reflecting surface finish.

The non-reflecting surface finish provides optimal glare reduction for the end user.

Reflektionsarmes Oberflächendesign.

Die speziell verarbeitete Instrumentenoberfläche absorbiert das Operationslicht und sorgt so für ein angenehmes Operieren ohne Lichtreflektion.

Micro Vascular
Mikro-Gefäß

INCHES

Micro Vascular Surgery – Mikro-Gefäßchirurgie

Titanium Micro Instruments

Titanium Mikro-Instrumente



Fatigue-free lightness: Aesculap® TITANIUM micro instruments.

- The extremely light TITANIUM material is an advantage for lengthy operations. This helps to carry on operating over longer time periods with minimum fatigue.
- The non-magnetic material makes working with particularly fine needles easier for you.

Ermüdungsfreie Leichtigkeit: Aesculap® TITANIUM Mikro-Instrumente.

- Das extrem leichte Titan kommt Ihnen vor allem bei lang andauernden Operationen entgegen. Wir unterstützen Sie dabei, möglichst ermüdungsfrei über längere Zeiträume hinweg zu arbeiten.
- Im Umgang mit besonders feinen Nadeln erleichtert Ihnen der nicht-magnetische Werkstoff das Arbeiten.

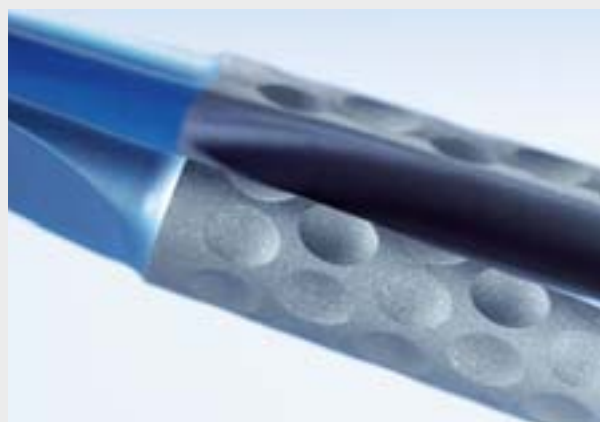

Incomparable operating sensitivity: the Aesculap golfball design.

With its unique handling properties, the exclusive Aesculap golfball design is becoming more and more popular among surgeons.

Feel the difference. Ergonomic and stable, the handle design helps to combat fatigue. The unique geometry of the handle grants a previously unattainable degree of freedom in instrument handling.

Unvergleichliches Operationsgefühl: Aesculap Golfball-Design.

Das exklusive Aesculap Golfball-Design findet dank des angenehmen Handlings immer mehr Freunde unter Chirurgen. Achten Sie auf Ihr Gefühl. Der Griff ist nicht nur ergonomisch und sicher, sondern er unterstützt Sie auch im ermüdungsfreien Arbeiten. Mit der ausgewogenen Griff-Geometrie des Instruments eröffnen Sie sich beim Handling einen nie dagewesenen Freiheitsgrad.

Micro Vascular Surgery – Mikro-Gefäßchirurgie

Titanium Micro Forceps

Titanium Mikro-Pinzetten

Micro Vascular
Mikro-Gefäß

INCHES

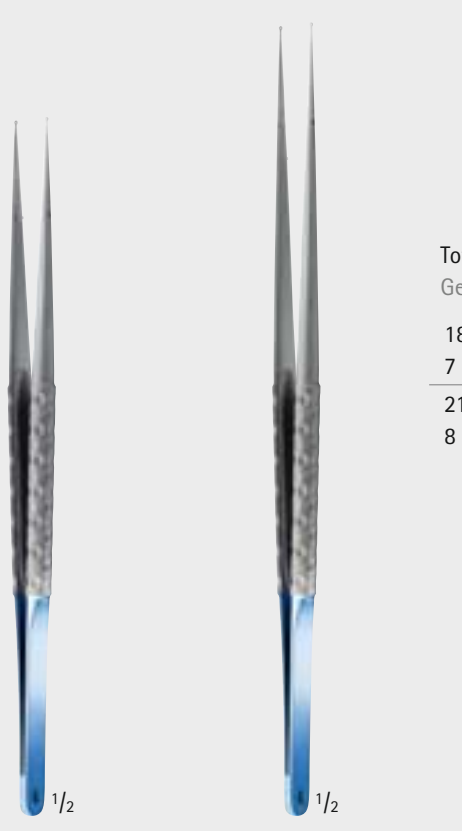

FM317T-FM337R
185 mm, 7 1/4"

FM318T-FM338T
210 mm, 8 1/4"

Jaw type Maulform	Diam. of ring: 1 mm, straight Ring-Ø: 1 mm, gerade Dia Dust®	Platform tips, straight Fadenplatte, gerade Dia Dust®	DeBakey tip, 1 mm DeBakey Zahnung, 1 mm
Total length Gesamtlänge			
185 mm 7 1/4"	FM317T	FM327T	FM337T
210 mm 8 1/4"	FM318T	FM328T	FM338T

Micro Vascular Surgery – Mikro-Gefäßchirurgie

Titanium Micro Needle Holders

Titanium Mikro-Nadelhalter

with ratchet
mit Sperre



Suture size
Nahtmaterialgröße

7/0 and smaller
7/0 und kleiner

5/0 and smaller
5/0 und kleiner

Total length
Gesamtlänge



185 mm
7 1/4"

FM258T

FM238T

210 mm
8 1/4"

FM259T

FM239T

without ratchet
ohne Sperre



Suture size
Nahtmaterialgröße

7/0 and smaller
7/0 und kleiner

5/0 and smaller
5/0 und kleiner

Total length
Gesamtlänge



185 mm
7 1/4"

FM252T

FM232T

210 mm
8 1/4"

FM253T

FM233T



FM232T-FM258T

185 mm, 7 1/4"



FM233T-FM259T

210 mm, 8 1/4"

Micro Vascular
Mikro-Gefäß

MILLIMETERS

Micro Vascular Surgery – Mikro-Gefäßchirurgie

Micro Scissors (Spring Type)

Mikro-Federscheren

Micro Vascular
Mikro-Gefäß

INCHES

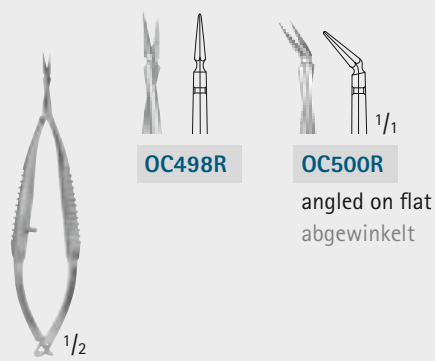

OC498R

OC500R

angled on flat
abgewinkelt

VANNAS

OC498R-OC500R

85 mm, 3 1/4"



MC CLURE

OC480R

95 mm, 3 3/4"

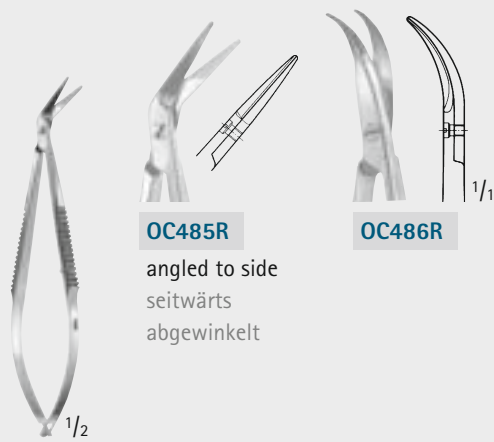

OC485R

OC486R

angled to side
seitwärts
abgewinkelt

CASTROVIEJO

OC485R-OC486R

95 mm, 3 3/4"

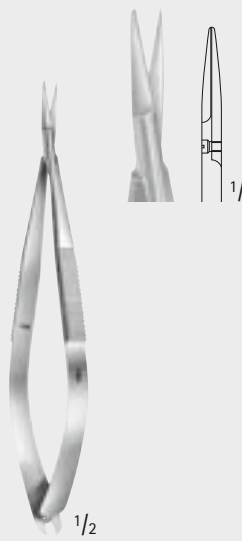

NOYES

OC482R

125 mm, 5"

Micro Vascular Surgery – Mikro-Gefäßchirurgie

Micro Scissors (Spring Type)

Mikro-Federscheren

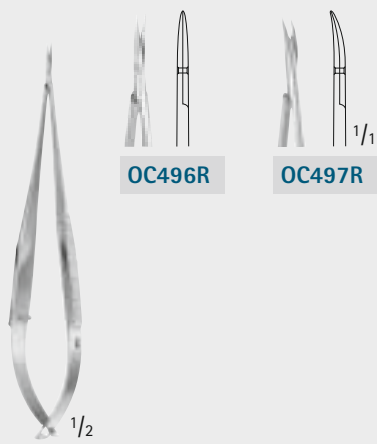

OC496R-OC497R

105 mm, 4 1/8"

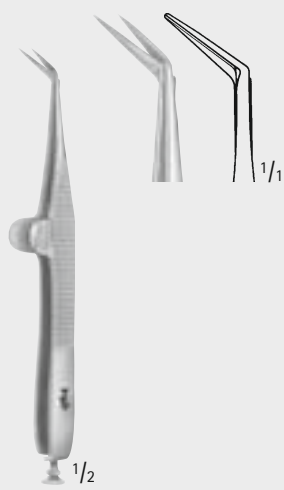

WECKER

OC461R

Eye scissors

Augenscherer

110 mm, 4 1/4"

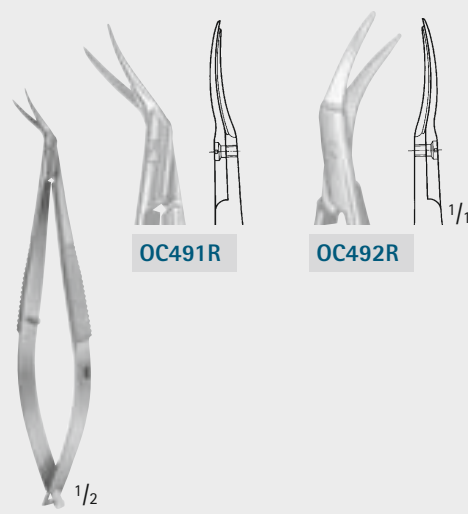

CASTROVIEJO

OC491R-OC492R

Eye scissors

Augenscherer

110 mm, 4 1/4"

Micro Vascular
Mikro-Gefäß

MILLIMETERS

Micro Vascular Surgery – Mikro-Gefäßchirurgie

Micro Scissors (Spring Type)

Mikro-Federscheren

... with flat handle and cross-serration

- flat handles, sure grip due to cross-serration

... mit Flachgriffen und Karoprofil

- breite Flachgriffe mit griffigem Karoprofil
- sichere Handhabung

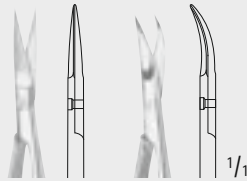

FD012R

FD013R



FD012R-FD013R

120 mm, 4 3/4"

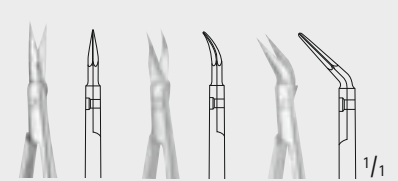

FD014R

FD015R

FD011R



VANNAS

FD011R-FD014R

120 mm, 4 3/4"

120 mm
4 3/4"

120 mm
4 3/4"

angled on flat
abgewinkelt
120 mm
4 3/4"

Vein scissors FD028R

for roughening vessel ends

- vessel cannot slip off
- clean, smooth cut

Venenschere FD028R

zum Auffrischen von Gefäßstümpfen

- kein Abgleiten des Gefäßes
- glatte, saubere Durchtrennung

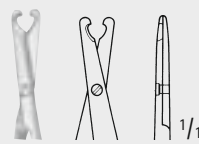

BIEMER

FD028R

Vein scissors
Venenschere
130 mm, 5 1/8"

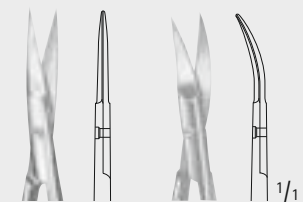

FD016R

FD017R



FD016R-FD017R

160 mm, 6 1/4"

Micro Vascular Surgery – Mikro-Gefäßchirurgie

Micro Scissors (Spring Type)

Mikro-Federscheren



FD018R **FD019R**

VANNAS
FD018R-FD019R
160 mm, 6 1/4"

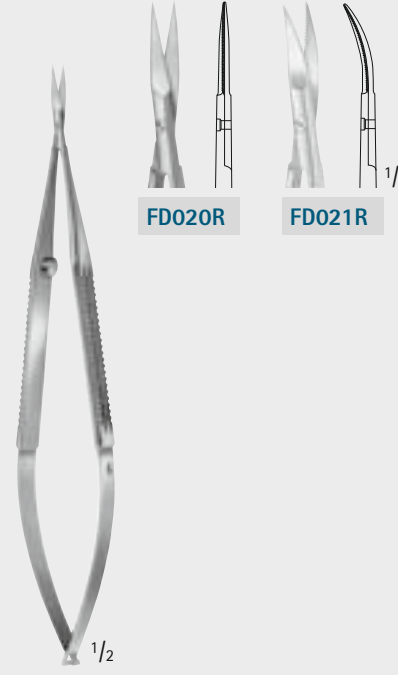

FD020R **FD021R**

MILLESi
FD020R-FD021R
Blades serrated
Schneiden gezahnt
160 mm, 6 1/4"

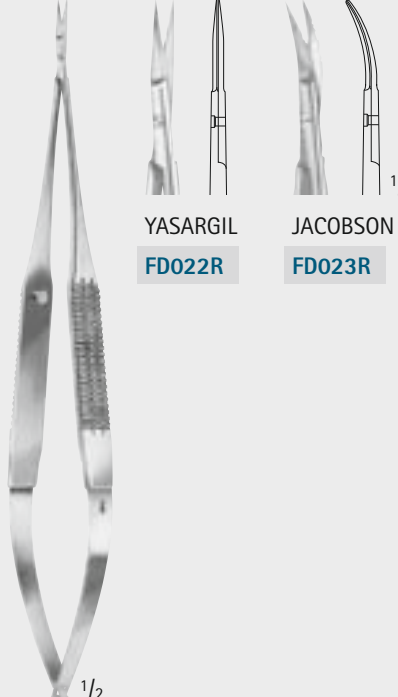

YASARGIL **JACOBSON**
FD022R **FD023R**

FD022R-FD023R
185 mm, 7 1/4"



FD100R **FD101R** **FD103R**

FD100R-FD103R
Micro dissecting scissors
Mikro-Präparierschere
145 mm, 5 3/4"



Micro Vascular
Mikro-Gefäß

MILLIMETERS

Micro Vascular Surgery – Mikro-Gefäßchirurgie

Micro Scissors (Spring Type)

Mikro-Federscheren

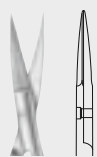

FM010R
sharp/sharp
spitz/spitz



FM011R
sharp/sharp
spitz/spitz



FM012R
sharp/blunt
spitz/stumpf



FM013R
blunt/blunt
stumpf/stumpf



FM014R
probe pointed/sharp
Kugel/spitz

1/2

MÜLLER

FM010R-FM014R

120 mm, 4 3/4"

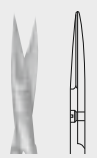

FM040R
sharp/sharp
spitz/spitz



FM041R
sharp/sharp
spitz/spitz



1/2

MÜLLER

FM040R-FM041R

170 mm, 6 3/4"

Micro Vascular
Mikro-Gefäß

Micro Vascular Surgery – Mikro-Gefäßchirurgie

Micro Scissors (Spring Type)

Mikro-Federscheren



$\frac{1}{1}$
sharp/sharp
spitz/spitz

$\frac{1}{2}$

FM042R

Micro scissors
Mikro-Schere
180 mm, 7"



$\frac{1}{1}$
sharp/sharp
spitz/spitz

$\frac{1}{2}$

FD251R

Micro scissors
Mikro-Schere
180 mm, 7"



$\frac{1}{1}$
1 blade probe pointed
1 Blatt mit Knopf

$\frac{1}{2}$

FM043R

Micro scissors
Mikro-Schere
180 mm, 7"



$\frac{1}{1}$
sharp/sharp,
1 blade serrated
spitz/spitz,
1 Blatt gezahnt

$\frac{1}{2}$

FD252R

Micro ligature scissors
for suture material 6/0 - 8/0
Mikro-Fadenschere
für Nahtmaterial von 6/0 bis 8/0
180 mm, 7"

Micro Vascular
Mikro-Gefäß

MILLIMETERS

Micro Vascular Surgery – Mikro-Gefäßchirurgie

Micro Scissors (Spring Type)

Mikro-Scheren

- Instrument length depends on the blade length or angle.
- Die Instrumentenlänge variiert in Abhängigkeit der Blattlänge oder des Blattwinkels.

- Delicate blade 10 mm
- Sehr feines Blatt 10 mm



FM437R
25°



FM438R
45°



FM439R
60°



FM440R
90°



FM441R
125°



FM442R
straight
gerade



FM436R
curved on flat
aufgebogen

- Ultra delicate blade 7 mm
- Extrem feines Blatt 7 mm



FM431R
25°



FM432R
45°



FM433R
60°



FM434R
90°



FM435R
125°



FM444R
straight
gerade



FM430R
curved on flat
aufgebogen



FM430R-FM444R
165 mm, 6 1/2"

Micro Vascular
Mikro-Gefäß

INCHES

Micro Vascular Surgery – Mikro-Gefäßchirurgie

Micro Scissors (Spring Type)

Mikro-Scheren

- Delicate blade 10 mm
- Sehr feines Blatt 10 mm



FM482R
25°



FM483R
45°



FM484R
60°



FM485R
90°



FM486R
125°



FM488R
straight
gerade



FM481R
curved on flat
aufgebogen

- Ultra delicate blade 7 mm
- Extrem feines Blatt 7 mm



FM504R
25°



FM505R
45°



FM506R
60°



FM507R
90°



FM508R
125°



FM503R
curved on flat
aufgebogen

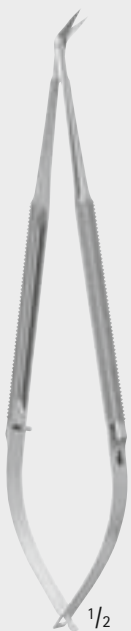

FM481R-FM508R

165 mm, 6 1/2"

Micro Vascular
Mikro-Gefäß

MILLIMETERS

Micro Vascular Surgery – Mikro-Gefäßchirurgie

Micro Suture Tying Forceps, Jewelers Forceps

Mikro-Knüpfpinzetten, Uhrmacher-Pinzetten



0.2 mm

1/2

1/1

BD330R
110 mm, 4 1/4"

0.15 mm

1/2

1/1

BD331R
110 mm, 4 1/4"

0.3 mm

1/2

1/1

BD329R
110 mm, 4 1/4"



0.2 mm

1/2

1/1

BD333R
115 mm, 4 1/2"

0.4 mm

1/2

1/1

1 x 2 teeth
1 x 2 Zähne

BD343R
115 mm, 4 1/2"

0.3 mm

1/2

1/1

BD335R
135 mm, 5 1/4"

0.4 mm

1/2

1/1

1 x 2 teeth
1 x 2 Zähne

BD345R
135 mm, 5 1/4"

Micro Vascular Surgery – Mikro-Gefäßchirurgie

Micro Suture Tying Forceps

Mikro-Knüpfpinzetten

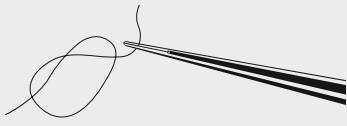

with plateau at the tips
mit Plateau an den Spitzen

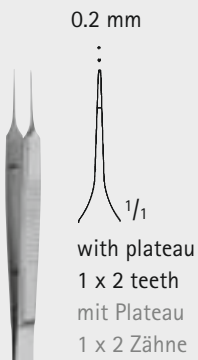

1/2

BONNER MODELL

BD505R

95 mm, 3 3/4"

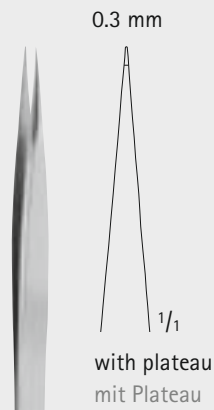

1/2

BD338R

120 mm, 4 3/4"

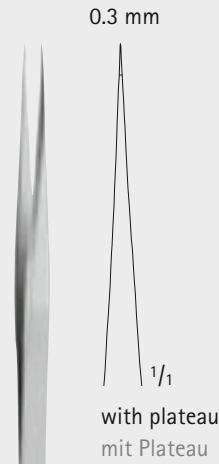

1/2

VISE

BD336R

135 mm, 5 1/4"

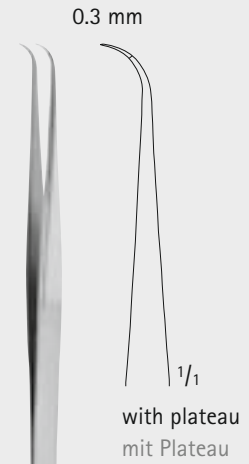

1/2

VISE

BD337R

135 mm, 5 1/4"

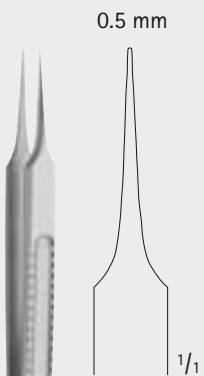

1/2

LAZAR

BD260R

155 mm, 6 1/8"

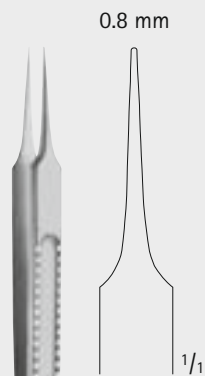

1/2

LAZAR

BD261R

155 mm, 6 1/8"

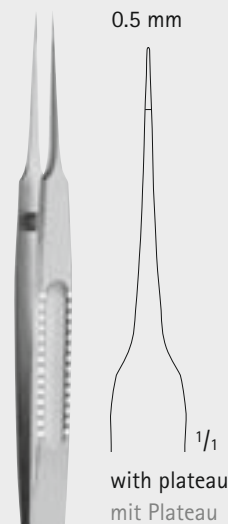

1/2

BD264R

185 mm, 7 1/4"

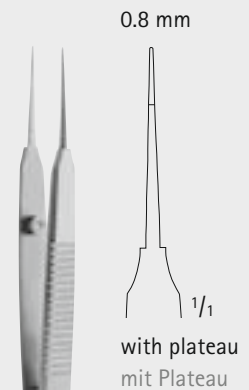

1/2

AUSTIN

BD340R

140 mm, 5 1/2"



Micro Vascular
Mikro-Gefäß

Micro Vascular Surgery – Mikro-Gefäßchirurgie

Micro Suture Tying Forceps

Mikro-Knüpfpinzetten



... with round handles

- Round handles allow turning manipulations between the fingers.
- Optimum balance individually for each instrument due to solid or hollowed-out handles.

... mit Rundgriffen

- Rundgriffe erlauben Drehbewegungen zwischen den Fingern.
- Optimale Balance, individuell je nach Instrument, durch volle oder gehöhlte Griffpartien.

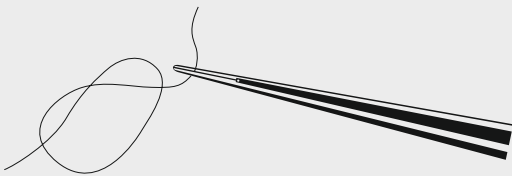

with plateau at the tips

mit Plateau an den Spitzen

Micro Vascular
Mikro-Gefäß

0.3 mm 0.3 mm

FD280R FD281R

1/2

FD280R-FD281R

120 mm, 4 3/4"

0.3 mm 0.3 mm

FD284R FD285R

1/2

FD284R-FD285R

150 mm, 6"

0.5 mm 0.5 mm

FD286R FD287R

1/2

FD286R-FD287R

180 mm, 7"

INCHES

Micro Vascular Surgery – Mikro-Gefäßchirurgie

Micro Vessel Dilator

Mikro-Gefäßdilator

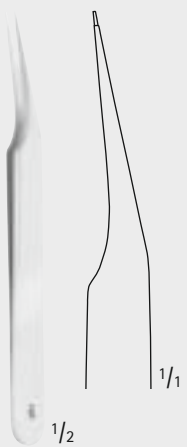

FB130R

Micro vessel dilator
Mikro-Gefäßdilator
115 mm, 4 1/2"



Micro Vascular Surgery – Mikro-Gefäßchirurgie

Dia Dust® Micro Forceps, Micro Ring Forceps, Atraumatic Forceps

Dia Dust® Mikro-Pinzetten, Mikro-Ringpinzette, Atraumatische Pinzette

Micro Vascular
Mikro-Gefäß

- The diamond dust coating ensures an even harder and more wear resistant surface on the inside of the jaws. Moreover, the structure of the Dia Dust® coating guarantees a reliable grip for fine needles and sutures, as well as for tissue.
- Die Diamantstaubbeschichtung sorgt für eine noch härtere und verschleißfestere Maulinnenfläche. Darüber hinaus garantiert die Struktur der Dia Dust®-Beschichtung ein zuverlässiges Fassen von feinen Nadeln und Nahtmaterialien sowie von Weichgewebe.

■ Dia Dust®



FD253R
Micro dissecting forceps
Anatomische Mikro-Pinzette
180 mm, 7"

■ Dia Dust®



FD255R-FD256R
Micro tissue forceps
Chirurgische Mikro-Pinzetten
180 mm, 7"



FM047R
Diam. of ring: 2 mm
Ring-Ø: 2 mm

FM047R
Micro ring forceps
Mikro-Ringpinzette
180 mm, 7"

■ ERGOPLANT

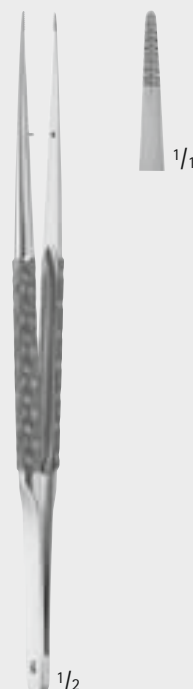

DX303R
Micro forceps
Mikro-Pinzette
180 mm, 7"

■ ATRAUMATA®

Toothing COOLEY

COOLEY Zahnung

Micro Vascular Surgery – Mikro-Gefäßchirurgie

Micro Needle Holders

Mikro-Nadelhalter

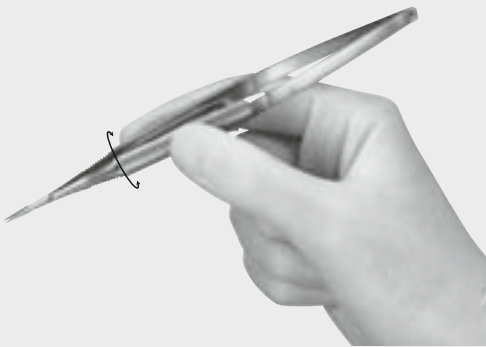

... with round handles

- Round handles allow turning manipulations between the fingers.
- Optimum balance individually for each instrument due to solid or hollowed-out handles.

... mit Rundgriffen

- Rundgriffe erlauben Drehbewegungen zwischen den Fingern.
- Optimale Balance, individuell je nach Instrument, durch volle oder gehöhlte Griffpartien.



Micro Vascular
Mikro-Gefäß



BARRAQUER
BM560R-BM562R
without ratchet
ohne Sperre
115 mm, 4 1/2"



BARRAQUER
FD230R-FD231R
without ratchet
ohne Sperre
120 mm, 4 3/4"



BARRAQUER
FD232R-FD233R
with ratchet
mit Sperre
120 mm, 4 3/4"

Micro Vascular Surgery – Mikro-Gefäßchirurgie

Micro Needle Holders

Mikro-Nadelhalter



Diagram showing the needle holder and its components: a straight needle (FD240R) and a curved needle (FD241R) with a 1/1 curvature. The holder is labeled REILL and has a 1/2 inch tip length.

FD240R **FD241R**

REILL

FD240R-FD241R
without ratchet
ohne Sperre
150 mm, 6"

Diagram showing the needle holder and its components: a straight needle (FD242R) and a curved needle (FD243R) with a 1/1 curvature. The holder has a ratchet and a 1/2 inch tip length.

FD242R **FD243R**

FD242R-FD243R
with ratchet
mit Sperre
150 mm, 6"

Diagram showing the needle holder and its components: a straight needle (FD244R) and a curved needle (FD245R) with a 1/1 curvature. The holder has a 1/2 inch tip length.

FD244R **FD245R**

FD244R-FD245R
without ratchet
ohne Sperre
185 mm, 7 1/4"

Diagram showing the needle holder and its components: a straight needle (FD246R) and a curved needle (FD247R) with a 1/1 curvature. The holder has a ratchet and a 1/2 inch tip length.



FD246R **FD247R**

FD246R-FD247R
with ratchet
mit Sperre
185 mm, 7 1/4"

Micro Vascular Surgery – Mikro-Gefäßchirurgie



Micro Needle Holders

Mikro-Nadelhalter

BM563R **BM564R**

CASTROVIEJO
BM563R-BM564R
with ratchet
mit Sperre
145 mm, 5 3/4"

FD076R **FD079R**



FD076R-FD079R
without ratchet
ohne Sperre
160 mm, 6 1/4"





FD080R **FD081R**

FD080R-FD081R
without ratchet
ohne Sperre
185 mm, 7 1/4"

FD045R **FD046R**

JACOBSON
FD045R-FD046R
without ratchet
ohne Sperre
with ratchet
mit Sperre
185 mm, 7 1/4"



FD048R

FD048R
with ratchet
mit Sperre
200 mm, 7 7/8"



Micro Vascular
Mikro-Gefäß

MILLIMETERS

Micro Vascular Surgery – Mikro-Gefäßchirurgie

Micro Needle Holders

Mikro-Nadelhalter



with locking mechanism
mit Anreichverriegelung

1/2

MÜLLER

FM021R

145 mm, 5 3/4"



with locking mechanism
mit Anreichverriegelung

1/2

MÜLLER

FM061R

180 mm, 7"

Micro Vascular
Mikro-Gefäß

Micro Vascular Surgery – Mikro-Gefäßchirurgie

Dia Dust® Micro Needle Holders

Dia Dust® Mikro-Nadelhalter



- The diamond dust coating ensures an even harder and more wear resistant surface on the inside of the jaws. Moreover, the structure of the Dia Dust® coating guarantees a reliable grip for fine needles and sutures, as well as for tissue.
- Die Diamantstaubbeschichtung sorgt für eine noch härtere und verschleißfestere Maulinnenfläche. Darüber hinaus garantiert die Struktur der Dia Dust®-Beschichtung ein zuverlässiges Fassen von feinen Nadeln und Nahtmaterialien sowie von Weichgewebe.



FD258R

FD259R

 $\frac{1}{2}$

FD258R-FD259R

with ratchet

Suture size: 7/0 and smaller

mit Sperre

Nahtmaterialgröße: 7/0 und kleiner

180 mm, 7"

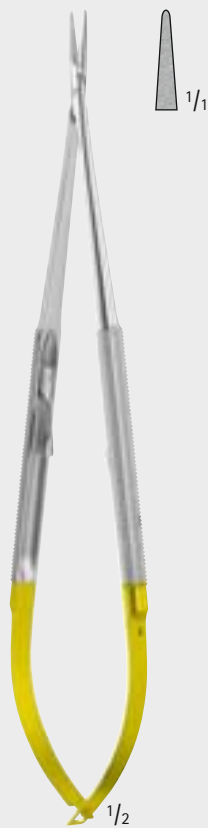
 $\frac{1}{1}$ $\frac{1}{2}$

FM236R

with ratchet

for suture material 5/0 and smaller

mit Sperre

für Nahtmaterial 5/0 und kleiner

210 mm, 8 1/4"

 $\frac{1}{1}$ $\frac{1}{2}$

FM276R

without ratchet

for suture material 5/0 and smaller

ohne Sperre

für Nahtmaterial 5/0 und kleiner

210 mm, 8 1/4"

Micro Vascular Surgery – Mikro-Gefäßchirurgie

Dia Dust® Micro Needle Holders

Dia Dust® Mikro-Nadelhalter



- The diamond dust coating ensures an even harder and more wear resistant surface on the inside of the jaws. Moreover, the structure of the Dia Dust® coating guarantees a reliable grip for fine needles and sutures, as well as for tissue.
- Die Diamantstaubbeschichtung sorgt für eine noch härtere und verschleißfestere Maulinnenfläche. Darüber hinaus garantiert die Struktur der Dia Dust®-Beschichtung ein zuverlässiges Fassen von feinen Nadeln und Nahtmaterialien sowie von Weichgewebe.

Micro Vascular
Mikro-Gefäß



FM520R-FM524R

120 mm, 4 3/4"



FM522R-FM528R

145 mm, 5 3/4"



FM521R-FM529R

160 mm, 6 1/4"

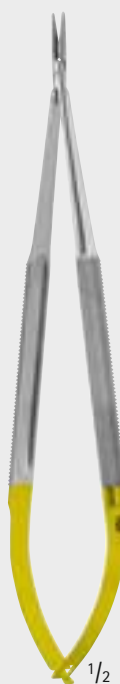

FM218R-FM530R

185 mm, 7 1/4"

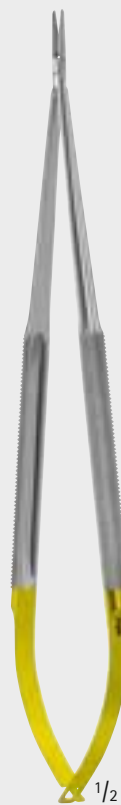

FM221R-FM531R

210 mm, 8 1/4"

INCHES





Micro Vascular Surgery – Mikro-Gefäßchirurgie

Dia Dust® Micro Needle Holders

Dia Dust® Mikro-Nadelhalter



with ratchet
mit Sperre

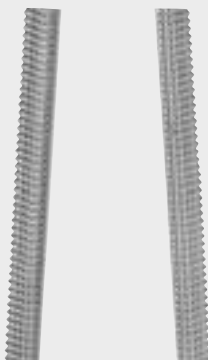

Total length Gesamtlänge	Suture size Nahtmaterialgröße			
	7/0 and smaller 7/0 und kleiner	5/0 and smaller 5/0 und kleiner	4/0 and smaller 4/0 und kleiner	4/0 and smaller 4/0 und kleiner
120 mm 4 3/4"	 FM520R			
145 mm 5 3/4"		FM522R		
160 mm 6 1/4"	FM521R	FM523R		
185 mm 7 1/4"	FM563R	FM564R	FM218R	
210 mm 8 1/4"	FM565R	FM566R	FM228R	FM221R

without ratchet
ohne Sperre



Total length Gesamtlänge	Suture size Nahtmaterialgröße	
	7/0 and smaller 7/0 und kleiner	5/0 and smaller 5/0 und kleiner
120 mm 4 3/4"	 FM524R	
145 mm 5 3/4"		FM528R
160 mm 6 1/4"	FM525R	FM529R
185 mm 7 1/4"	FM526R	FM530R
210 mm 8 1/4"	FM527R	FM531R

Micro Vascular
Mikro-Gefäß

MILLIMETERS

Micro Vascular Surgery – Mikro-Gefäßchirurgie

Dia Dust® Micro Needle Holders

Dia Dust® Mikro-Nadelhalter



- The diamond dust coating ensures an even harder and more wear resistant surface on the inside of the jaws. Moreover, the structure of the Dia Dust® coating guarantees a reliable grip for fine needles and sutures, as well as for tissue.
- Die Diamantstaubbeschichtung sorgt für eine noch härtere und verschleißfestere Maulinnenfläche. Darüber hinaus garantiert die Struktur der Dia Dust®-Beschichtung ein zuverlässiges Fassen von feinen Nadeln und Nahtmaterialien sowie von Weichgewebe.

Micro Vascular
Mikro-Gefäß



FM541R-FM546R

145 mm, 5 3/4"



FM540R-FM545R

170 mm, 6 3/4"



FM542R-FM547R

185 mm, 7 1/4"



FM543R-FM548R

210 mm, 8 1/4"



Micro Vascular Surgery – Mikro-Gefäßchirurgie

Dia Dust® Micro Needle Holders

Dia Dust® Mikro-Nadelhalter

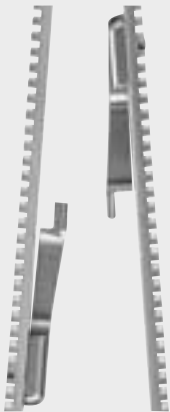

with ratchet
mit Sperre

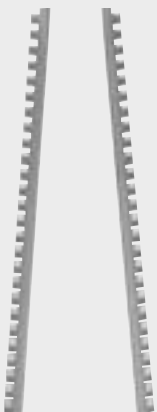

Total length Gesamtlänge	Suture size Nahtmaterialgröße	
	7/0 and smaller 7/0 und kleiner	5/0 and smaller 5/0 und kleiner
145 mm 5 3/4"		 FM541R
170 mm 6 3/4"	FM540R	
185 mm 7 1/4"		FM542R
210 mm 8 1/4"		FM543R

without ratchet
ohne Sperre



Total length Gesamtlänge	Suture size Nahtmaterialgröße	
	7/0 and smaller 7/0 und kleiner	5/0 and smaller 5/0 und kleiner
145 mm 5 3/4"		 FM546R
170 mm 6 3/4"	FM545R	
185 mm 7 1/4"		FM547R
210 mm 8 1/4"		FM548R

Micro Vascular
Mikro-Gefäß

MILLIMETERS

Micro Vascular Surgery – Mikro-Gefäßchirurgie

DUROGRIP® Micro Needle Holders

DUROGRIP® Mikro-Nadelhalter

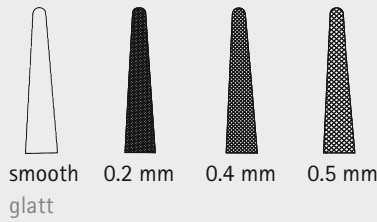
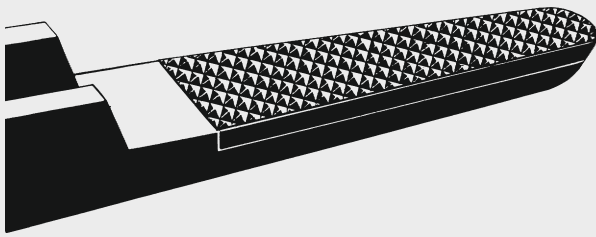

- Aesculap needle holders have jaws with tungsten carbide inserts and according to the use required the resp. structure can be chosen. A smooth jaw surface as well as 3 different serrations ensure a sure „grip“ of the resp. needle.
- Aesculap Nadelhalter sind durch die Struktur der Hartmetall-Maulteile auf das jeweilige, indikationsbezogene Nahtmaterial abgestimmt. Eine glatte Maulfläche sowie 3 verschiedene Haftprofile garantieren den sicheren „Grip“ der jeweiligen Nadel.

- We recommend tungsten carbide inserts
 - with smooth jaw surface for suture material 9/0 - 11/0
 - with 0.2 mm pitch of serration for suture material 6/0 - 10/0
 - 0.4 mm 4/0 - 6/0
 - 0.5 mm up to 3/0
- Wir empfehlen Hartmetall-Maulteile
 - mit glatter Fläche für Nahtmaterial 9/0 - 11/0
 - mit Teilung 0,2 mm für Nahtmaterial 6/0 - 10/0
 - 0,4 mm 4/0 - 6/0
 - 0,5 mm bis 3/0



DUROGRIP® Needle holders with tungsten carbide inserts

- Identification:
 - gold-plated handle ends
- Kennzeichnung:
 - Vergoldete Branchenenden

Micro Vascular
Mikro-Gefäß



with smooth jaw
mit glattem Maul

CASTROVIEJO
BM001R
145 mm, 5 3/4"



CASTROVIEJO
BM002R
145 mm, 5 3/4"



BM003R
180 mm, 7"

Micro Vascular Surgery – Mikro-Gefäßchirurgie

DUROGRIP® Micro Needle Holders

DUROGRIP® Mikro-Nadelhalter



1/2
0.2 1/1
CASTROVIEJO
BM004R
180 mm, 7"



1/2
0.2 1/1
CASTROVIEJO
BM005R
215 mm, 8 1/2"



1/2
0.2 1/1
FM388R
180 mm, 7"



1/2
0.2 1/1
FM390R
200 mm, 8"



Micro Vascular Surgery – Mikro-Gefäßchirurgie

Mini Vessel Clips and Approximators

Mini Gefäßclips und Approximatoren

for temporary occlusion

- Blade gripping surface with oblique serrations for safe but careful gripping of vessels.
- Fixed closing pressure.
- Closing force is measured at 1/3 of the blades at 1 mm opening (see illustration).

für temporären Gebrauch

- Maulinnenflächen schräg gerieft, für schonendes, sicheres Festhalten der Gefäße.
- Fest eingestellter Schließdruck.
- Schließkraft-Ermittlung: bei 1/3 der Gesamtmaullänge von vorn und einer Maulöffnung von 1 mm (siehe Zeichnung).

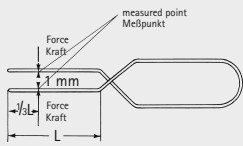

BIEMER

Art. No. Art. Nr.		Jaw opening Maulöffnung	Jaw length Maullänge	Closing force Schließkraft	Applying forceps Anlegepinzette
FD560R		4 mm	6 mm	30 - 40 g (0.29 - 0.39 N)	FD568R or FD569R FD568R oder FD569R
FD561R		5 mm	9 mm	30 - 40 g (0.29 - 0.39 N)	FD568R or FD569R FD568R oder FD569R
FD562R		5 mm	9 mm	20 - 25 g (0.20 - 0.25 N)	FD568R or FD569R FD568R oder FD569R

(identified by gold-plated spring ends)

for vessels diam. 0.5 - 2.0 mm.

(gekennzeichnet durch vergoldete Federenden)

für Gefäße mit Ø 0,5 - 2,0 mm.

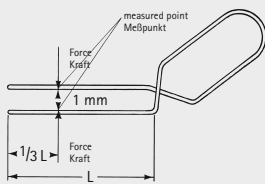

MEHDORN

Art. No. Art. Nr.		Jaw opening Maulöffnung	Jaw length Maullänge	Closing force Schließkraft	Applying forceps Anlegepinzette
FD552R		2 mm	4 mm	10 - 15 g (0.10 - 0.15 N)	FD578R
FD554R		2 mm	4 mm	15 - 20 g (0.15 - 0.20 N)	FD578R
FD556R		3 mm	6 mm	10 - 15 g (0.10 - 0.15 N)	FD578R
FD558R		3 mm	6 mm	15 - 20 g (0.15 - 0.20 N)	FD578R

(identified by gold-plated spring ends)

for vessels diam. 0.5 - 1.5 mm.

(gekennzeichnet durch vergoldete Federenden)

für Gefäße mit Ø 0,5 - 1,5 mm.

Micro Vascular
Mikro-Gefäß

INCHES

Micro Vascular Surgery - Mikro-Gefäßchirurgie

Applying Forceps for Vessel Clips and Approximators

Anlegepinzetten für Gefäßclips und Approximatoren

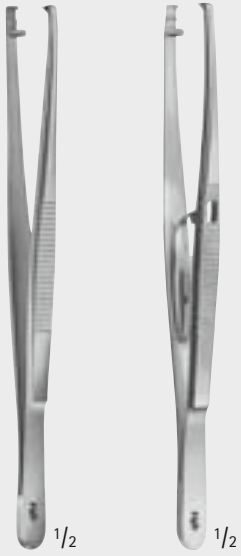

FD568R

without lock
ohne Schloss

FD569R

with lock
mit Schloss

BIEMER

FD568R-FD569R

Applying forceps for BIEMER vessel clips and BIEMER-MÜLLER and MÜLLER approximators
Anlegepinzetten für Gefäßclips nach BIEMER und Approximatoren nach BIEMER-MÜLLER und MÜLLER
140 mm, 5 1/2"



Various positions of clips possible
Die Position des Clips ist variabel

MEHDORN

FD578R

Applying forceps for MEHDORN vessel clips
Anlegepinzette für Gefäßclips nach MEHDORN
150 mm, 6"



Micro Vascular
Mikro-Gefäß

Micro Vascular Surgery – Mikro-Gefäßchirurgie

Mini Vessel Clips and Approximators

Mini Gefäßclips und Approximatoren









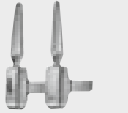
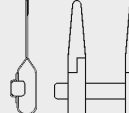

For micro vascular anastomosis in the superficial range

- Blade gripping surface with oblique serrations for careful but safe holding of the vessel ends.
- Fixed closing pressure.
- Adjustable distance between the clips and automatic fixation by tilting.
- Even when applied, the lightweight construction allows easy, distortionless turning and makes suturing possible on the other side of the vessel.

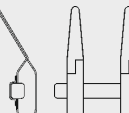
Für Mikro-Gefäßanastomosen im oberflächlichen Bereich

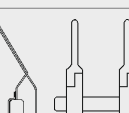
- Maulinnenflächen schräg gerieft, für schonendes, sicheres Festhalten der Gefäßenden.
- Fest eingestellter Schließdruck.
- Der Abstand zwischen den Clips ist durch einfaches Verschieben variabel und wird durch Verkantung selbsttätig fixiert.
- Die leichte Konstruktion (geringes Gewicht, kleine Dimension) ermöglicht im angelegten Zustand einfaches, verzerrungsfreies Umdrehen, um auf der unteren Gefäßseite weiterzunähen.

BIEMER-MÜLLER

Art. No. Art. Nr.			Jaw opening Maul- öffnung	Jaw length Maul- länge	Closing force Schließkraft	Applying forceps Anlege- pinzette
FD611R			3 mm	9 mm	25 - 30 g (0.25 - 0.29 N)	FD568R or / oder FD 569R
FD612R			3 mm	9 mm	25 - 30 g (0.25 - 0.29 N)	FD568R or / oder FD569R
FD613R			4 mm	9 mm	25 - 30 g (0.25 - 0.29 N)	FD568R or / oder FD569R
FD614R			3 mm	9 mm	25 - 30 g (0.25 - 0.29 N)	FD568R or / oder FD569R
FD615R			3 mm	4.5 mm	25 - 30 g (0.25 - 0.29 N)	FD568R or / oder FD569R
BIEMER FD571R			2 mm	6 mm	30 - 40 g (0.29 - 0.39 N)	FD572R

Micro approximators
Mikro-Approximatoren

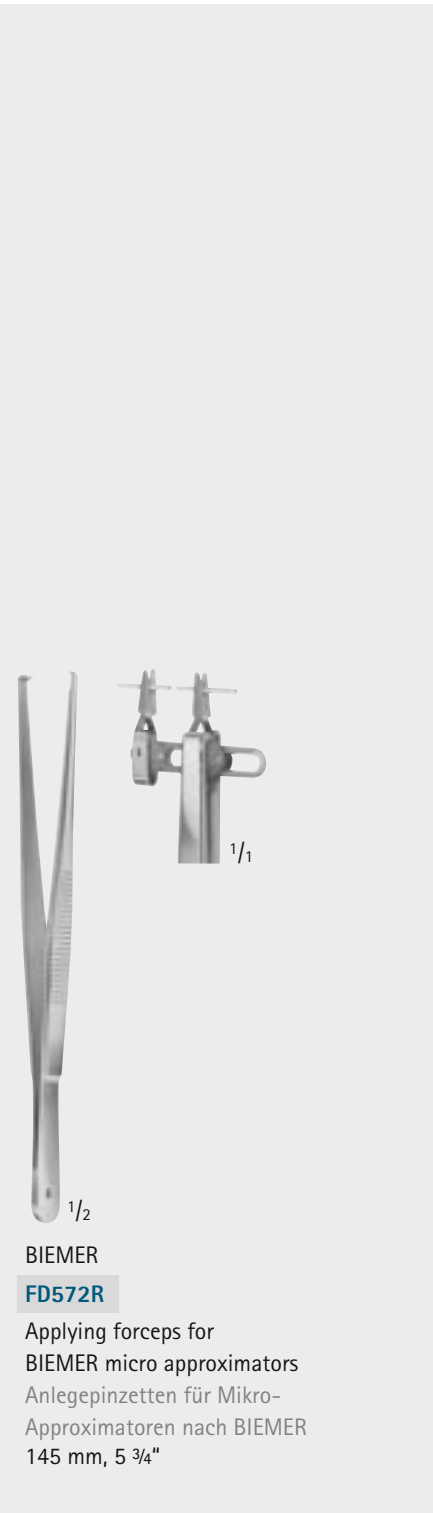

BIEMER

FD572R

Applying forceps for
BIEMER micro approximators
Anlegepinzetten für Mikro-
Approximatoren nach BIEMER
145 mm, 5 3/4"

Micro Vascular
Mikro-Gefäß

INCHES

Micro Vascular Surgery – Mikro-Gefäßchirurgie

Approximators

Approximatoren

For micro vascular anastomosis in the deeper range,
also for experimental surgery

- Blade gripping surface with oblique serrations for careful but safe holding of the vessel ends.
- The pressure measure is adjusted with wrench FD576R.
- The distance between the clips is variable and fixed with wrench FD576R.

Für Mikro-Gefäßanastomosen im tieferen Bereich,
außerdem für die experimentelle Chirurgie

- Maulinnenflächen schräg gerieft, für schonendes, sicheres Festhalten der Gefäßenden.
- Der Schließdruck wird mit dem Schlüssel FD576R eingestellt.
- Der Abstand zwischen den Clips ist variabel und wird mit dem Schlüssel FD576R fixiert.

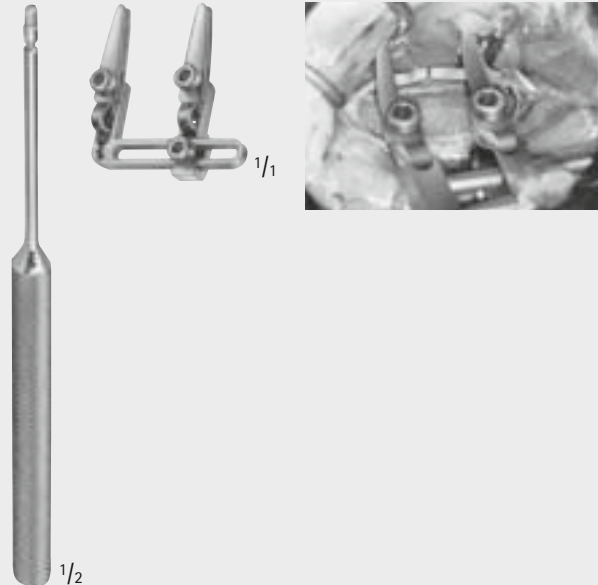
**FD575R**

Approximator, complete
with wrench FD576R

Approximatoren komplett,
mit Schlüssel FD576R

For safe adaption of nerve anastomoses

- Piercing the nerve centre with fine needles prevents strong pathological changes.
- Needles can be exchanged with wrench FD576R.
- Distance between the needles is variable and can be fixed with wrench FD576R.

Zur sicheren Adaption bei Nervanastomosen

- Das Durchstrecken des Nervenzentrum mit feinen Nadeln verhindert stärkere pathologische Veränderungen.
- Nadeln mit Schlüssel FD576R austauschbar.
- Abstand zwischen den Nadeln variabel und mit Schlüssel FD576R fixierbar.

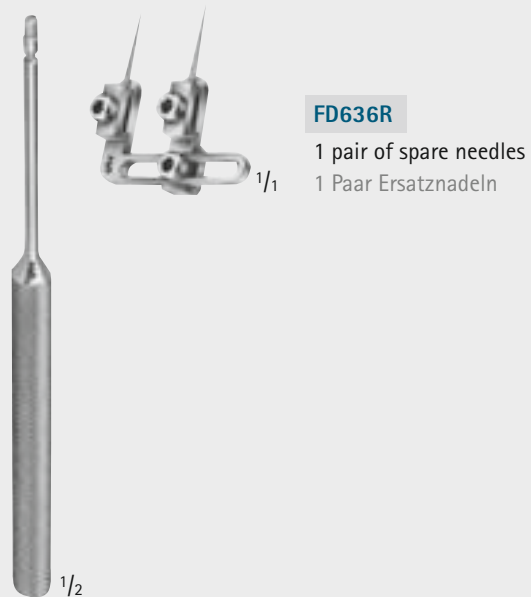

BIEMER

FD635R

Nerv approximator, complete
with wrench FD576R

Nerv-Approximator, komplett
mit Schlüssel FD576R

Micro Vascular Surgery – Mikro-Gefäßchirurgie

Vessel Clips

Gefäßclips



FD871R



FD875R



FD879R

Vessel Clips / Gefäßclips

Art. No. Art. Nr.	FD870R	FD871R	FD872R	FD873R	FD874R	FD875R	FD876R	FD877R	FD878R	FD879R
Length Länge	8 mm	8 mm	11 mm	11 mm	16 mm	16 mm	24 mm	24 mm	35 mm	35 mm
	Artery / Arterie	Vein / Vene	Artery / Arterie	Vein / Vene	Artery / Arterie	Vein / Vene	Artery / Arterie	Vein / Vene	Artery / Arterie	Vein / Vene
Designation Bezeichnung	B-1		B-2		B-3		HD-S		RD-S	



FD881R



FD885R



FD889R

Vessel Clips / Gefäßclips

Art. No. Art. Nr.	FD880R	FD881R	FD882R	FD883R	FD884R	FD885R	FD886R	FD887R	FD888R	FD889R
Length Länge	8 mm	8 mm	11 mm	11 mm	16 mm	16 mm	24 mm	24 mm	35 mm	35 mm
	Artery / Arterie	Vein / Vene	Artery / Arterie	Vein / Vene	Artery / Arterie	Vein / Vene	Artery / Arterie	Vein / Vene	Artery / Arterie	Vein / Vene
Designation Bezeichnung	ABB-11		ABB-22		ABB-33		HD-D		RD-D	



FD891R



FD895R

Vessel Clips / Gefäßclips

Art. No. Art. Nr.	FD890R	FD891R	FD892R	FD893R	FD894R	FD895R
Length Länge	8 mm	8 mm	11 mm	11 mm	16 mm	16 mm
	Artery / Arterie	Vein / Vene	Artery / Arterie	Vein / Vene	Artery / Arterie	Vein / Vene
Designation Bezeichnung	ABB-1		ABB-2		ABB-3	

Micro Vascular
Mikro-Gefäß

INCHES

Micro Vascular Surgery – Mikro-Gefäßchirurgie

Vessel Clips

Gefäßclips

- The arterial clips have a slightly inwards curved jaw tip to prevent slipping, see Fig. 1.
Die arteriellen Clips weisen eine leicht nach innen gebogene Maulform auf, um ein Abgleiten zu verhindern, siehe Abb. 1.
- The venous clips have a flat parallel closing jaw, see Fig. 2.
Die venösen Clips haben eine flache Maulform und schließen parallel, siehe Abb. 2.

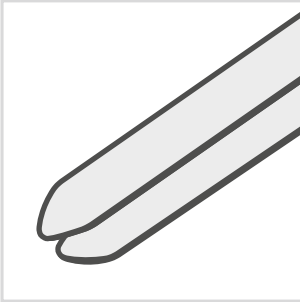

Fig. 1
Abb. 1

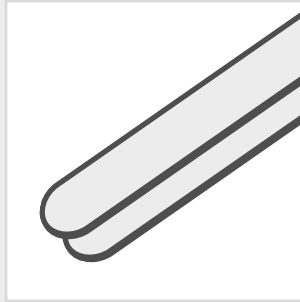

Fig. 2
Abb. 2

Length Länge	8 mm	11 mm	16 mm	24 mm	35 mm
For vessel diameter Für Gefäß- durchmesser	0.3 - 1.0 mm	0.6 - 1.4 mm	1.0 - 1.2 mm	1.5 - 3.3 mm	2.0 - 5.0 mm



$\frac{1}{2}$

ACLAND

FD896R-FD897R

Applying forceps

Clip-Anlegepinzette

140 mm, 5 $\frac{1}{2}$ "



FD896R

for 8-11 mm clips
für 8-11 mm Clips



$\frac{1}{1}$

FD897R

for 14-36 mm clips
für 14-36 mm Clips

Micro Vascular Surgery – Mikro-Gefäßchirurgie

Mini Vessel Clips and Approximators

Mini Gefäßclips und Approximatoren

SCHWARTZ

Art. No. Art. Nr.	Length Länge	Jaw length Maullänge	Jaw width Maulbreite	Jaw type Maulform	Closing force Schließkraft
FD622R	25 mm, 1"	8 mm	2 mm	0°	4.0 N
FD623R	25 mm, 1"	8 mm	2 mm	25°	4.0 N
FD624R	25 mm, 1"	8 mm	2 mm	45°	4.0 N

Temporary vessel clips
Temporäre Gefäßclips



SCHWARTZ

FD628R

Applying forceps
for SCHWARTZ vessel clips

Anlegezange

für Gefäßclips nach SCHWARTZ

190 mm, 7 1/2"

Bone Instruments
Knocheninstrumente



Bone Instruments – Knocheninstrumente

Elevators

Elevatoren



4.5 mm 4.5 mm

OM307R OM308R

KÖNIG
OM307R-OM308R
155 mm, 6 1/8"

5.5 mm

FK110R

155 mm, 6 1/8"

9 mm

CAIRNS
FK141R
175 mm, 6 7/8"

5 mm

WILLIGER
FK120R
165 mm, 6 1/2"

5.5 mm

WILLIGER
FK121R
170 mm, 6 3/4"

Bone Instruments - Knocheninstrumente

Elevators

Elevatoren

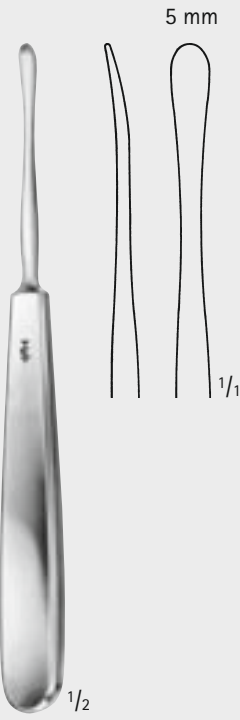

5 mm

1/1

1/2

SEBILEAU
FK124R
175 mm, 6 7/8"

Detailed description: This panel shows the SEBILEAU elevator. On the left is a photograph of the instrument, which has a long, slender handle and a thin, slightly curved blade. To the right are two line drawings of the blade: one showing the full length and the other showing a 5 mm section of the tip. A '1/1' label is placed below the second drawing. A '1/2' label is placed below the photograph.

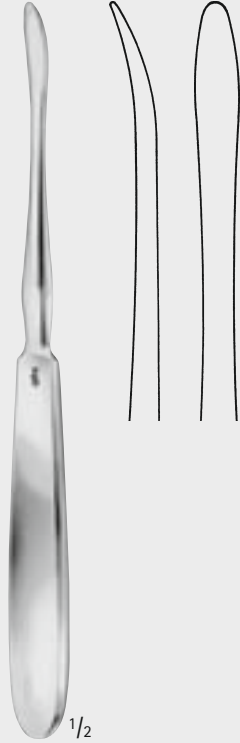

6 mm

1/1

1/2

QUERVAIN
FK133R
195 mm, 7 3/4"

Detailed description: This panel shows the QUERVAIN elevator. On the left is a photograph of the instrument, featuring a long handle and a blade with a distinct hook-like tip. To the right are two line drawings of the blade: one showing the full length and the other showing a 6 mm section of the tip. A '1/1' label is placed below the second drawing. A '1/2' label is placed below the photograph.

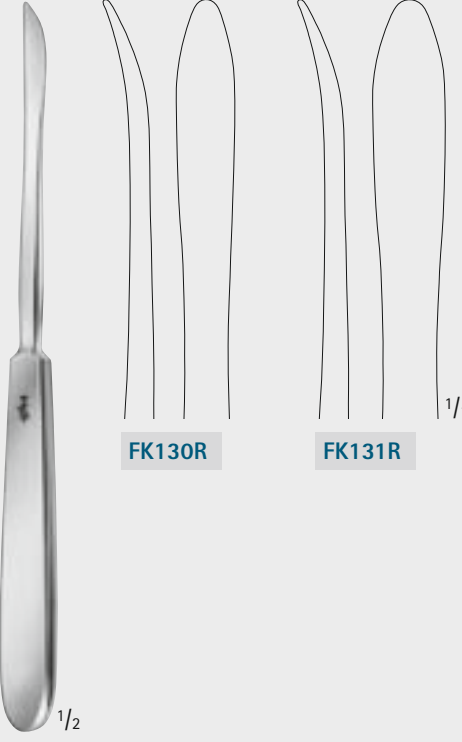

8 mm

10 mm

1/1

FK130R

FK131R

1/2

LANGENBECK
FK130R-FK131R
195 mm, 7 3/4"

Detailed description: This panel shows two models of the LANGENBECK elevator. On the left is a photograph of the FK130R model, which has a long handle and a blade with a hook tip. To the right are line drawings for both models: FK130R (8 mm tip) and FK131R (10 mm tip). Each drawing is accompanied by a '1/1' label. A '1/2' label is placed below the photograph.

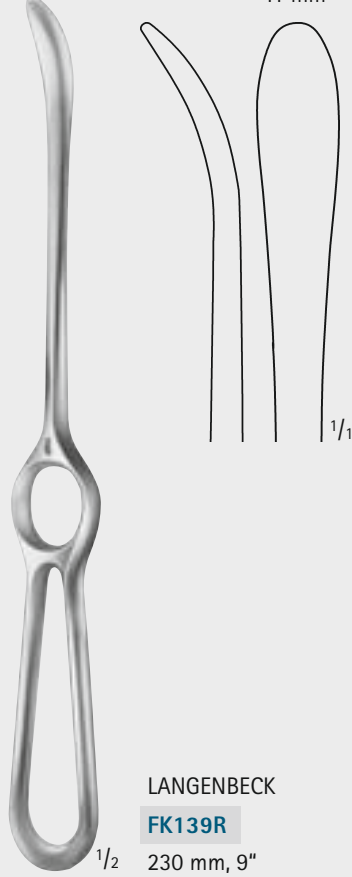

11 mm

1/1

1/2

LANGENBECK
FK139R
230 mm, 9"

Detailed description: This panel shows the FK139R model of the LANGENBECK elevator. On the left is a photograph of the instrument, which has a long handle with a circular ring at the base and a blade with a hook tip. To the right are two line drawings of the blade: one showing the full length and the other showing an 11 mm section of the tip. A '1/1' label is placed below the second drawing. A '1/2' label is placed below the photograph.

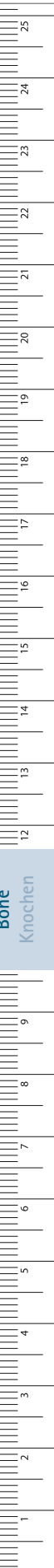

Bone Instruments – Knocheninstrumente

Elevator, Raspatories, Syndesmotomes

Elevator, Raspatorien, Syndesmotome



3.3 mm

1/2

HALLE
OL160R
blunt
stumpf
180 mm, 7"

4 mm

1/2

FREER
OL163R
blunt
stumpf
190 mm, 7 1/2"

4 mm

1/2

FREER
OL162R
sharp
scharf
190 mm, 7 1/2"

5.9 mm

1/2

SEWALL
OL198R
sharp
scharf
200 mm, 7 7/8"



Bone
Knochen

1/2

CHOMPRET
DO501R-DO504R
Syndesmotomes
Syndesmotome
150 mm, 6"

DO502R

DO503R

1/1

DO504R

Bone Instruments – Knocheninstrumente

Elevators, Raspatories

Elevatoren, Raspatorien

PENNINGTON
OL151R
 Raspatory
 Raspatorium
 210 mm, 8 1/4"

COTTLE
OL152R
 Elevator, graduated
 Elevatorium mit Graduierung
 200 mm, 7 7/8"

MASING
OL153R
 Elevator, graduated
 Elevatorium mit Graduierung
 200 mm, 7 7/8"

OBWEGESER-FREER
OL169R
 Elevator, blunt/sharp
 Elevatorium, stumpf/scharf
 210 mm, 8 1/4"

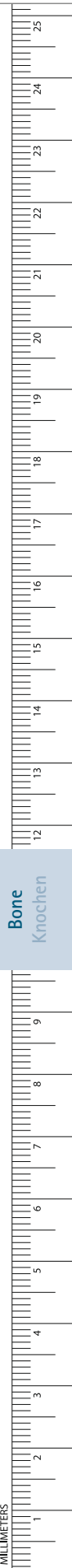

Bone Instruments – Knocheninstrumente

Raspatories

Raspatorien



HOWARTH
OL171R
sharp/blunt
scharf/stumpf
215 mm, 8 1/2"

FREER
OL159R
sharp
scharf
175 mm, 6 7/8"

■ ERGOPLANT

DX203R
for soft tissue
sharp/blunt
für Weichgewebe
scharf/stumpf
195 mm, 7 3/4"

Bone
Knochen

COTTLE
OL155R
sharp/sharp
scharf/scharf
200 mm, 7 7/8"

HILL
OL179R
blunt/semi-sharp
stumpf/halbscharf
220 mm, 8 3/4"

Bone Instruments - Knocheninstrumente

Raspatories

Raspatorien



MEAD
DO520R
sharp/sharp
scharf/scharf
165 mm, 6 1/2"

1/2 1/1

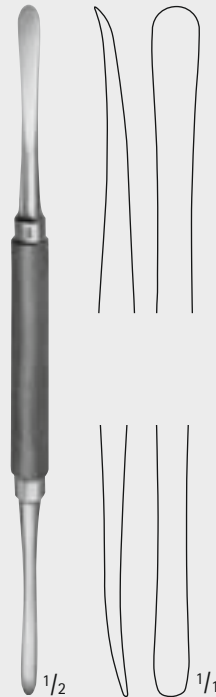

MOLT
DO543R
sharp/sharp
scharf/scharf
180 mm, 7"

1/2 1/1



4 mm

SYME
DO547R
sharp
scharf
185 mm, 7 1/4"

1/2 1/1

4 mm



ROBERTS
DO548R
blunt
stumpf
185 mm, 7 1/4"

1/2 1/1

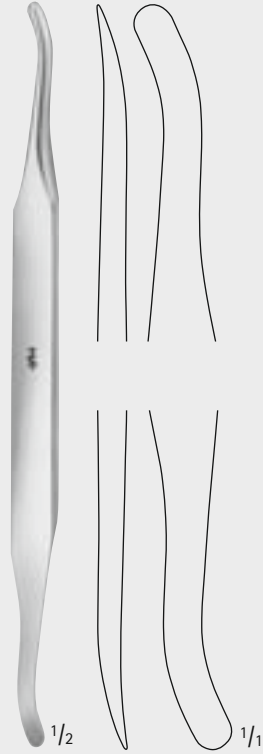

SELDIN
DO552R
sharp/sharp
scharf/scharf
195 mm, 7 3/4"

1/2 1/1

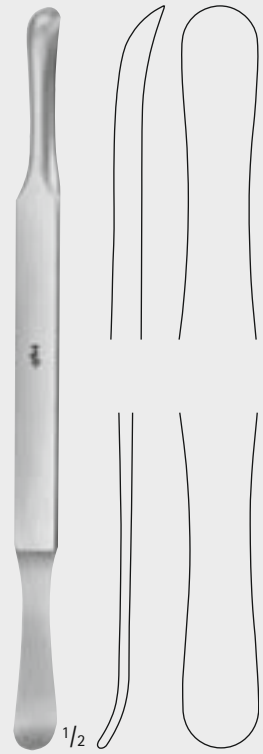

SELDIN
DO553R
sharp/blunt
scharf/stumpf
195 mm, 7 3/4"

1/2 1/1

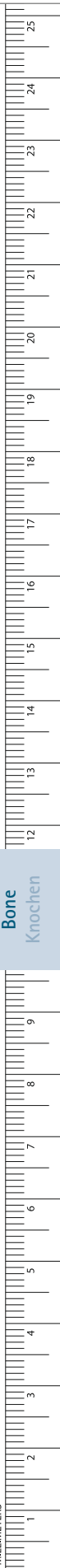

Bone Instruments – Knocheninstrumente

Raspatories

Raspatorien



KILLIAN
OL170R
 blunt/sharp
 stumpf/scharf
 185 mm, 7 1/4"

MAC DONALD
FK291R
 blunt/blunt
 stumpf/stumpf
 185 mm, 7 1/4"



WATSON-CHEYNE
FK292R-FK293R

2 mm

2 mm

2.5 mm

2.7 mm

FK292R
 blunt/blunt
 stumpf/stumpf
 130 mm, 5 1/8"

FK293R
 blunt/blunt
 stumpf/stumpf
 190 mm, 7 1/2"

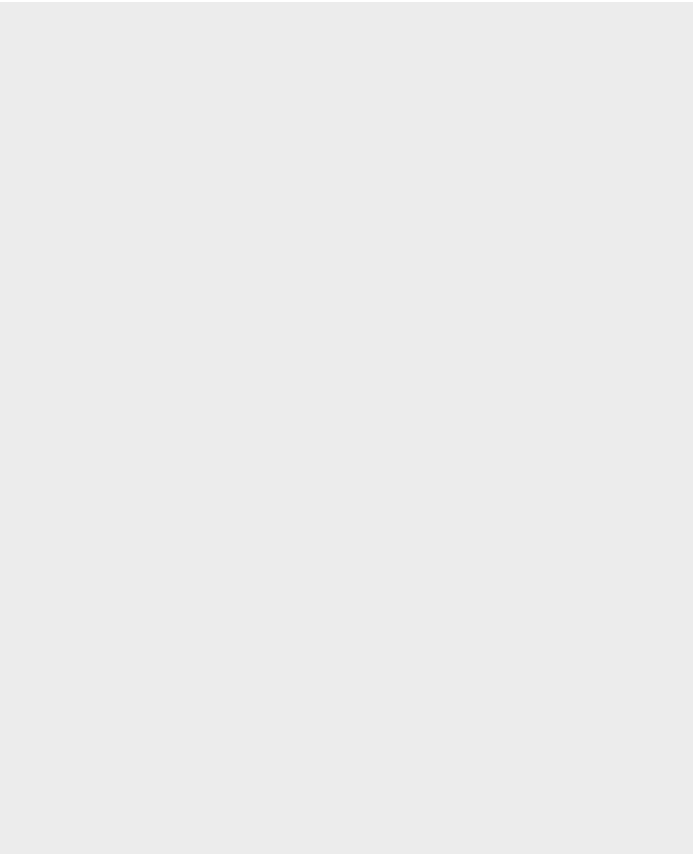

Bone
Knochen

Bone Instruments - Knocheninstrumente

Raspatories Raspatorien



4 mm

1/2

4.5 mm

1/1

FREER

OL164R

sharp/blunt
scharf/stumpf

180 mm, 7"

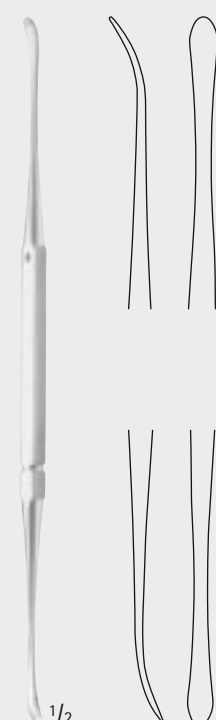

4 mm

1/2

3.5 mm

1/1

FREER

OL165R

blunt/sharp
stumpf/scharf

185 mm, 7 1/4"

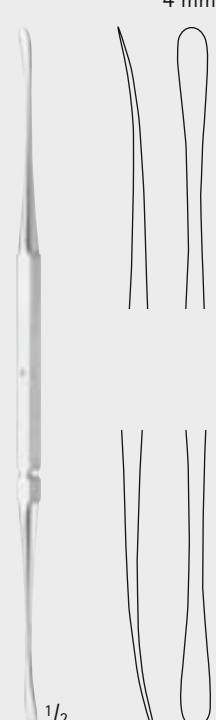

4 mm

1/2

3.5 mm

1/1

FREER

OL154R

blunt/sharp
stumpf/scharf

185 mm, 7 1/4"

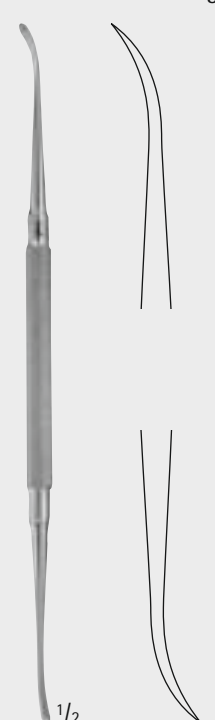

3 mm

1/2

3 mm

1/1

FREER-YASARGIL

OL166R

sharp/sharp
scharf/scharf

185 mm, 7 1/4"







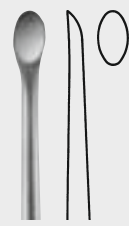

1/2

MANNERFELT MODIF.

FK530R-FK552R

155 mm, 6 1/8"

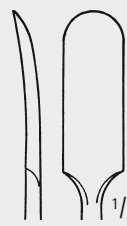
						
FK530R	FK532R	FK534R	FK541R	FK542R	FK543R	FK552R
4 mm	7 mm	9 mm	3 mm	6 mm	6 mm	8 mm

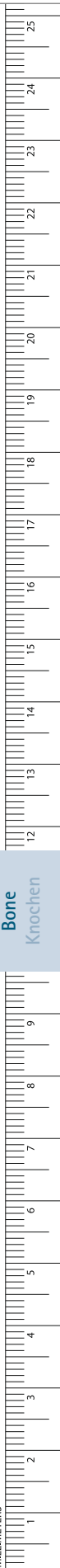

Bone
Knochen

Bone Instruments – Knocheninstrumente

Raspatories

Raspatorien



3.2 mm

1/2

LEMPERT
OG165R
semi-sharp
halbscharf
165 mm, 6 1/2"

6.3 mm

1/2

LEMPERT
OG164R
sharp
scharf
185 mm, 7 1/4"

5 mm

1/2

ADSON
FK299R
sharp
scharf
165 mm, 6 1/2"

3.2 mm

1/2

DO611R

4.6 mm

1/2

DO612R

PARTSCH
DO611R-DO612R
sharp
scharf
150 mm, 6"

4 mm

1/2

DO642R

PARTSCH MOD. LANGE
sharp
scharf
145 mm, 5 3/4"

4.5 mm

1/2

OL192R

MC KENTY
sharp
scharf
150 mm, 6"

5 mm

1/2

OM309R

KÖNIG
sharp
scharf
155 mm, 6 1/8"

Bone Instruments - Knocheninstrumente

Raspatories Raspatorien

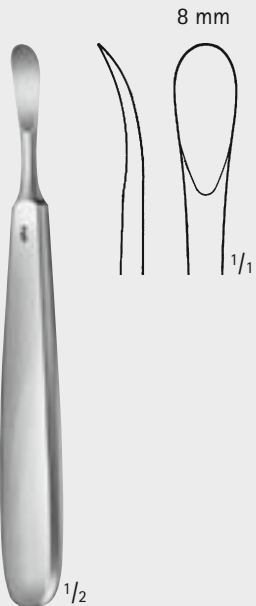

8 mm

$\frac{1}{2}$

$\frac{1}{1}$

TRELAT
OM311R
150 mm, 6"



4 mm

4 mm

$\frac{1}{2}$

$\frac{1}{1}$

OM314R **OM315R**

OM314R-OM315R
140 mm, 5 $\frac{1}{2}$ "

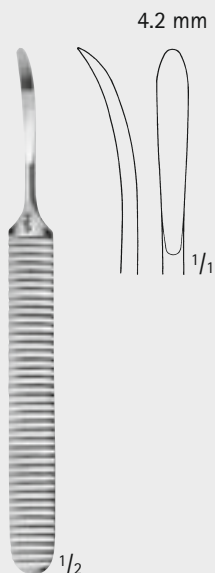

4.2 mm

$\frac{1}{2}$

$\frac{1}{1}$

WILLIGER
DO510R
140 mm, 5 $\frac{1}{2}$ "

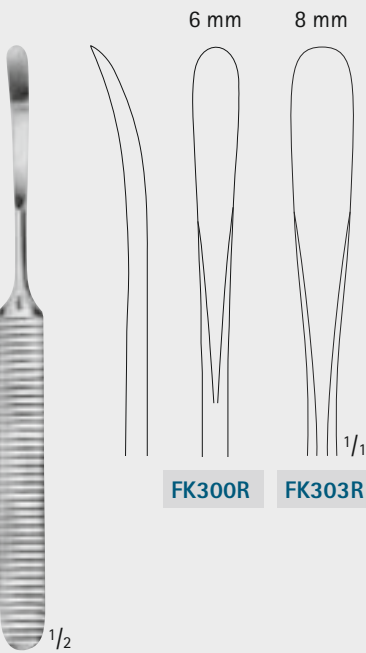

6 mm

8 mm

$\frac{1}{2}$

$\frac{1}{1}$

WILLIGER
FK300R-FK303R
160 mm, 6 $\frac{1}{4}$ "

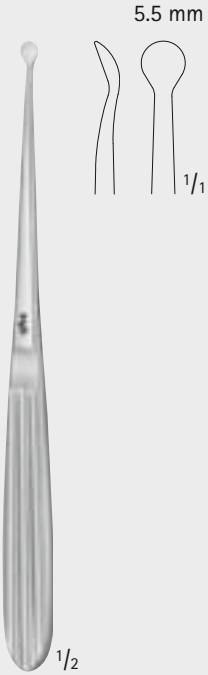

5.5 mm

$\frac{1}{2}$

$\frac{1}{1}$

WARD
DO546R
170 mm, 6 $\frac{3}{4}$ "

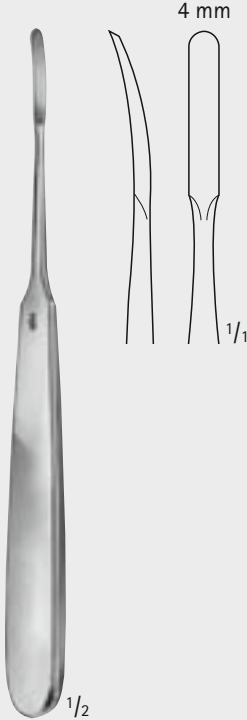

4 mm

$\frac{1}{2}$

$\frac{1}{1}$

JOSEPH
FK310R
180 mm, 7"

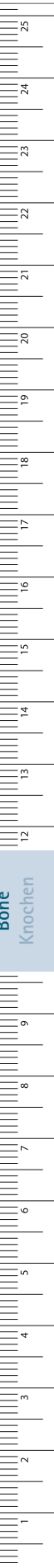

Bone Instruments – Knocheninstrumente

Raspatories

Raspatorien



FK319R
 curved, straight tip
 gebogen, Spitze gerade
 190 mm, 7 1/2"

FK318R
 straight, straight tip
 gerade, Spitze gerade
 190 mm, 7 1/2"

FK321R
 curved, round tip
 gebogen, Spitze rund
 190 mm, 7 1/2"

**Bone
Knochen**

FK362R
JANSEN
 strongly curved
 stark gebogen
 165 mm, 6 1/2"

FK301R **FK302R**
 slightly curved
 leicht gebogen
 165 mm, 6 1/2"

OL180R
PLESTER
 straight
 gerade
 180 mm, 7"

Bone Instruments - Knocheninstrumente

Raspatories Raspatorien

4 mm

1/1

1/2

MÜHLING
FK394R
sharp
scharf
165 mm, 6 1/2"

8 mm

1/1

1/2

COTTLE
OL157R
sharp
scharf
195 mm, 7 3/4"

14 mm

1/1

1/2

JANSEN
OL161R
Raspatory, sharp
Raspatorium, scharf
195 mm, 7 3/4"

4.7 mm

1/1

1/2

LANDOLT
FK314R
sharp
scharf
175 mm, 6 7/8"

6.2 mm

1/1

1/2

CASPAR
FK328R
sharp
scharf
180 mm, 7"

6.2 mm

1/1

1/2

CASPAR
FK329R
semi-sharp
halbscharf
180 mm, 7"

6 mm

1/1

1/2

DO523R
sharp
scharf
170 mm, 6 3/4"

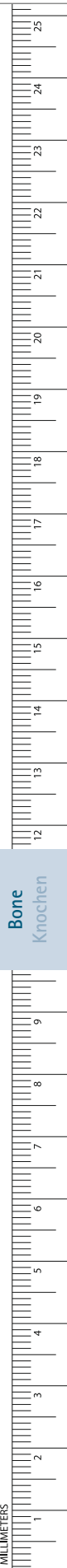

Bone Instruments – Knocheninstrumente

Raspatories

Raspatorien



6 mm 7 mm 9 mm 11 mm

OL140R OL141R OL142R OL143R

OBWEGESER
OL140R-OL143R
 sharp
 scharf
 180 mm, 7"

8 mm 7 mm 7 mm 7 mm

FK306R FK308R FK307R FK309R

ADSON
FK306R-FK309R
 170 mm, 6 3/4"

9.5 mm

BÜCHS
DO518R
 190 mm, 7 1/2"

Bone Instruments – Knocheninstrumente

Raspatories Raspatorien

17 mm

$\frac{1}{2}$

$\frac{1}{1}$

LANGENBECK
MB279R

sharp
scharf
190 mm, 7 $\frac{1}{2}$ "

12.5 mm

$\frac{1}{2}$

$\frac{1}{1}$

FARABEUF
FK340R

sharp
scharf
140 mm, 5 $\frac{1}{2}$ "

12.5 mm

$\frac{1}{2}$

$\frac{1}{1}$

FARABEUF
FK341R

sharp
scharf
140 mm, 5 $\frac{1}{2}$ "

11 mm

$\frac{1}{2}$

$\frac{1}{1}$

FARABEUF-COLLIN
FK344R

sharp
scharf
160 mm, 6 $\frac{1}{4}$ "

11 mm

$\frac{1}{2}$

$\frac{1}{1}$

FARABEUF-COLLIN
FK345R

sharp
scharf
160 mm, 6 $\frac{1}{4}$ "

18 mm

$\frac{1}{2}$

$\frac{1}{1}$

SEDILLOT
FK350R

sharp
scharf
185 mm, 7 $\frac{1}{4}$ "

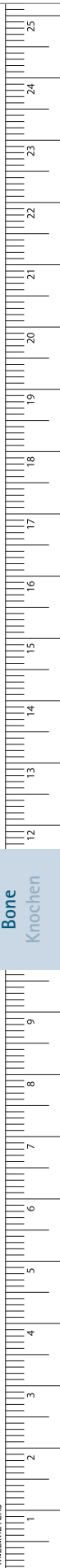

Bone Instruments – Knocheninstrumente

Raspatories

Raspatorien



11 mm

1/2

MC KISSOCK
FK379R
sharp
scharf
195 mm, 7 3/4"

10 mm

1/2

KRÄMER
FK390R
sharp
scharf
185 mm, 7 1/4"

10 mm

1/2

KRÄMER
FK391R
sharp
scharf
190 mm, 7 1/2"

6 mm

1/2

PENNYBACKER
FK378R
sharp
scharf
165 mm, 6 1/2"

16 mm

1/2

LANGENBECK
FK360R
sharp
scharf
190 mm, 7 1/2"

14 mm

1/2

LANGENBECK
FK361R
sharp
scharf
180 mm, 7"

Bone Instruments - Knocheninstrumente

Raspatories

Raspatorien



DOYEN

FK400R-FK401R

for children

für Kinder

175 mm, 6 7/8"

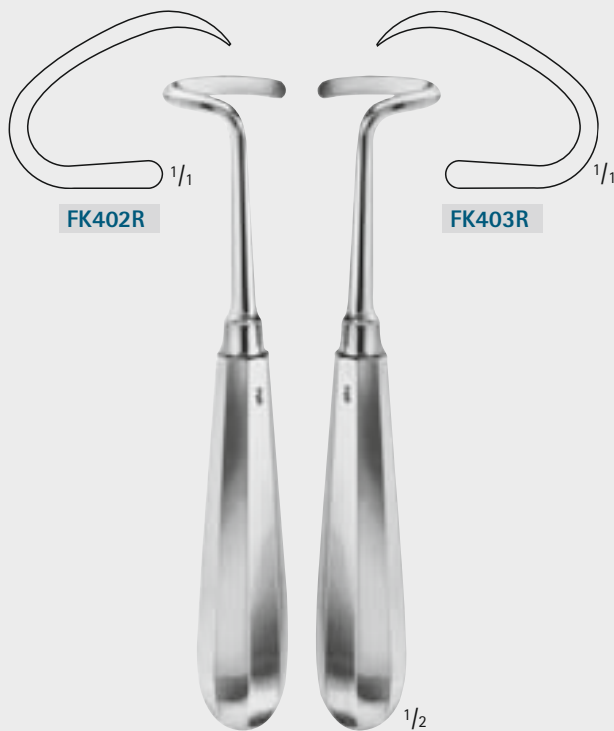

DOYEN

FK402R-FK403R

for adults

für Erwachsene

175 mm, 6 7/8"

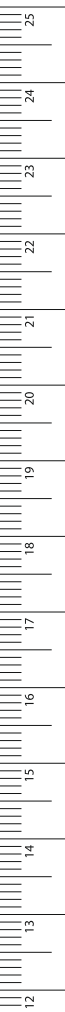

Bone
Knochen

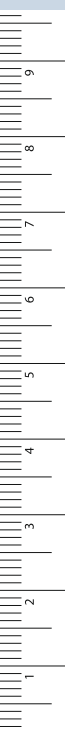

MILLIMETERS

Bone Instruments – Knocheninstrumente

Bone Curettes

Scharfe Löffel



JACOBSON
FK813R
140 mm, 5 1/2"

MARTINI
FK800R
140 mm, 5 1/2"

MARTINI
FK801R
140 mm, 5 1/2"

WILLIGER
FK814R
145 mm, 5 3/4"

JANZEN
FK803R
160 mm, 6 1/4"

BARTH
FK817R
180 mm, 7"

FK850R
210 mm, 8 1/4"

DO605R
175 mm, 6 7/8"

MILLER
DO606R
180 mm, 7"

Bone
Knochen

Bone Instruments – Knocheninstrumente

Bone Curettes

Scharfe Löffel

2.8 x 3.2 mm

1/2

HOUSE

2.6 x 3.5 mm

OG178R

oval cups
oval
150 mm, 6"

2.2 x 3.8 mm

1/2

HOUSE

2.8 x 4.8 mm

OG179R

oval cups, extra large
oval, extra groß
150 mm, 6"

0.6 x 0.8 mm

1/2

HOUSE

0.8 x 1.0 mm

OG186R

oval cups, angled
oval, kniegebogen
150 mm, 6"

1.5 x 2.5 mm

1/2

SHEA

OG180R

oval cups
oval
160 mm, 6 1/4"

1/2

HOUSE

Art. No.	Tip
Art. Nr.	Arbeitsende
OG181R	Diam. 1.0 + 1.2 mm Ø 1,0 + 1,2 mm
OG182R	Diam. 1.5 + 1.8 mm Ø 1,5 + 1,8 mm

oval cups
oval
150 mm, 6"

1/2

HOUSE

Art. No.	Tip
Art. Nr.	Arbeitsende
OG184R	Diam. 1.0 + 1.2 mm Ø 1,0 + 1,2 mm
OG185R	Diam. 1.5 + 1.8 mm Ø 1,5 + 1,8 mm

oval cups, strongly angled
oval, stark abgewinkelt
150 mm, 6"

1/2

OG189R

angled cups
pointed, large
abgebogen
spitz, groß
170 mm, 6 3/4"

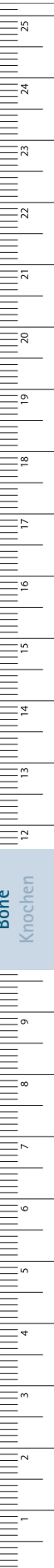

Bone Instruments – Knocheninstrumente

Bone Curettes

Scharfe Löffel



DO650R
160 mm, 6 1/4"

JANSEN
DO651R
160 mm, 6 1/4"

HEMINGWAY
DO655R
170 mm, 6 3/4"

HEMINGWAY
DO656R
170 mm, 6 3/4"

HEMINGWAY
DO670R
Fig. 0
170 mm, 6 3/4"

■ ERGOPLANT

LUCAS
DX220R
190 mm, 7 1/2"

Bone
Knochen

Bone Instruments – Knocheninstrumente

Bone Curettes

Scharfe Löffel

HEMINGWAY
DO671R
Fig. 1
170 mm, 6 3/4"

HEMINGWAY
DO672R
Fig. 2
170 mm, 6 3/4"

HEMINGWAY
DO673R
Fig. 3
170 mm, 6 3/4"

HEMINGWAY
DO674R
Fig. 4
170 mm, 6 3/4"

LUCAS
DO608R
180 mm, 7"

LUCAS
DO609R
185 mm, 7 1/4"

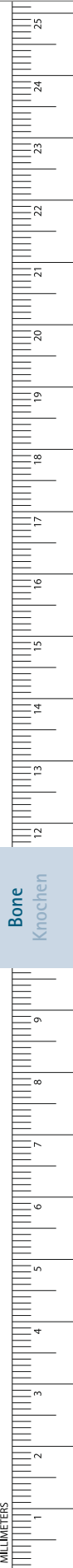

Bone Instruments – Knocheninstrumente

Endaural Curettes

Scharfe Löffel



UFFENORDE
FK660R
 170 mm, 6 3/4"

UFFENORDE
FK661R
 170 mm, 6 3/4"

BRUNS
FK611R-FK617R
 165 mm, 6 1/2"

3 mm Fig. 000 FK611R	4 mm Fig. 00 FK612R	5 mm Fig. 0 FK613R	6 mm Fig. 1 FK614R
8 mm Fig. 2 FK615R	10 mm Fig. 3 FK616R	12 mm Fig. 4 FK617R	

SCHEDE
FK621R-FK627R
 170 mm, 6 3/4"

2.5 mm Fig. 000 FK621R	3.4 mm Fig. 00 FK622R	4.2 mm Fig. 0 FK623R	5.2 mm Fig. 1 FK624R
6.3 mm Fig. 2 FK625R	7.4 mm Fig. 3 FK626R	8 mm Fig. 4 FK627R	

Bone Instruments - Knocheninstrumente

Endaural Curettes

Scharfe Löffel



2.8 mm 3.6 mm 4.4 mm 5.2 mm 6.8 mm 8.5 mm

Fig. 0000 Fig. 000 Fig. 00 Fig. 0 Fig. 1 Fig. 2

FK630R **FK631R** **FK632R** **FK633R** **FK634R** **FK635R**

10 mm 11.5 mm 13 mm 14.5 mm

Fig. 3 Fig. 4 Fig. 5 Fig. 6

FK636R **FK637R** **FK638R** **FK639R**

VOLKMANN
FK630R-FK639R
170 mm, 6 3/4"



3.4 mm 5.2 mm

Fig. 00 Fig. 1

FK658R **FK659R**

WILLIGER
FK658R-FK659R
170 mm, 6 3/4"



1.8 mm 2.0 mm 2.4 mm 2.6 mm 2.8 mm

FK675R **FK676R** **FK677R** **FK678R** **FK679R**

LEMPERT
FK675R-FK679R
215 mm, 8 1/2"

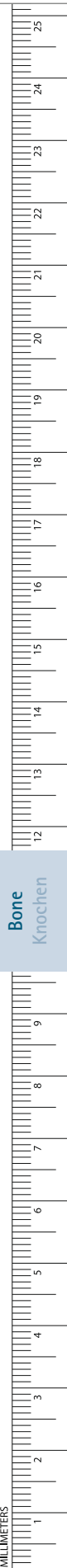

Bone
Knochen

Bone Instruments – Knocheninstrumente

Endaural Curettes

Scharfe Löffel



malleable
biegsam

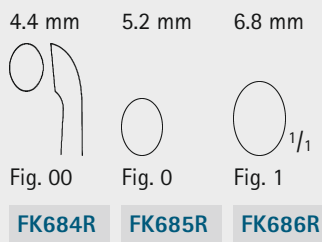

HALLER

FK684R-FK686R

215 mm, 8 1/2"

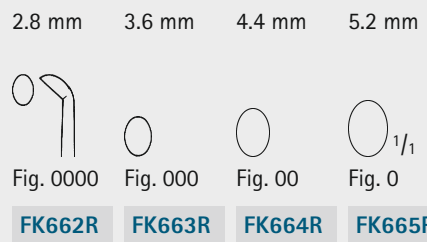

DAUBENSPECK

FK662R-FK665R

200 mm, 7 7/8"

Bone Instruments – Knocheninstrumente

Chisels, Gouges, Osteotomes

Flach- und Hohlmeißel, Osteotome



1/2

FREER

Art. No.	Tip (mm)
Art. Nr.	Arbeitsende (mm)
OL311R	4.0

Chisel
Flachmeißel
160 mm, 6 1/4"



1/2

FREER

Art. No.	Tip (mm)
Art. Nr.	Arbeitsende (mm)
OL314R	4.0

Chisel, curved
Flachmeißel, gebogen
160 mm, 6 1/4"

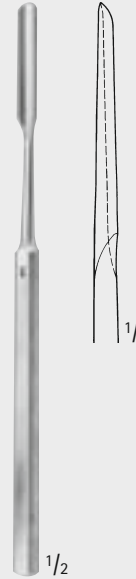

1/2

FREER

Art. No.	Tip (mm)
Art. Nr.	Arbeitsende (mm)
OL316R	6.0

Gauge
Hohlmeißel
150 mm, 6"



1/2

MANNERFELT MODIF.

Art. No.	Tip (mm)
Art. Nr.	Arbeitsende (mm)
FL144R	4
FL146R	6
FL148R	8

Osteotomes
Osteotome
155 mm, 6 1/8"



1/2

MANNERFELT MODIF.

Art. No.	Tip (mm)
Art. Nr.	Arbeitsende (mm)
FL153R	3

Gauge
Hohlmeißel
150 mm, 6"



6 mm

1/2

BALLENGER

OL318R

Septum gauge with notch, straight
Septum-Hohlmeißel mit Kerbe, gerade
150 mm, 6"

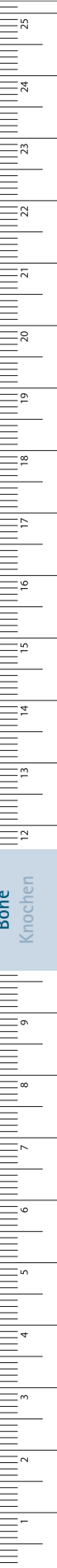

Bone Instruments – Knocheninstrumente

Osteotomes

Osteotome

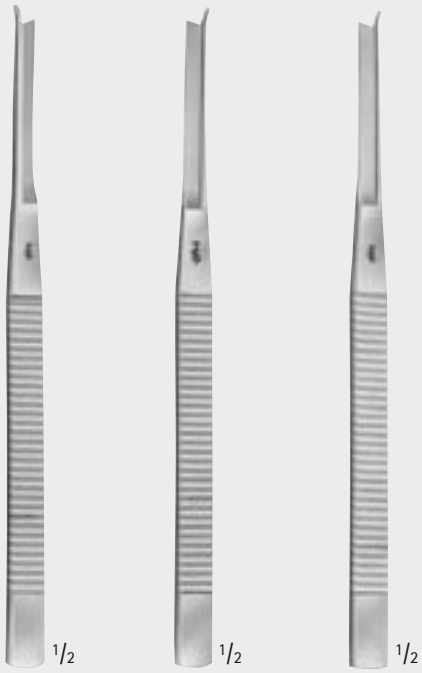

OL321R curved left
links gebogen

OL322R curved right
rechts gebogen

OL323R straight
gerade

MASING

OL321R-OL323R

single guarded
mit einseitig verrundeter Ecke
175 mm, 6 7/8"

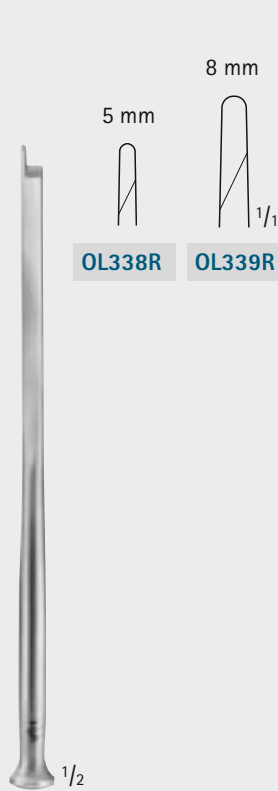

FOMON

OL338R-OL339R

single guarded
mit einseitig verrundeter Ecke
170 mm, 6 3/4"

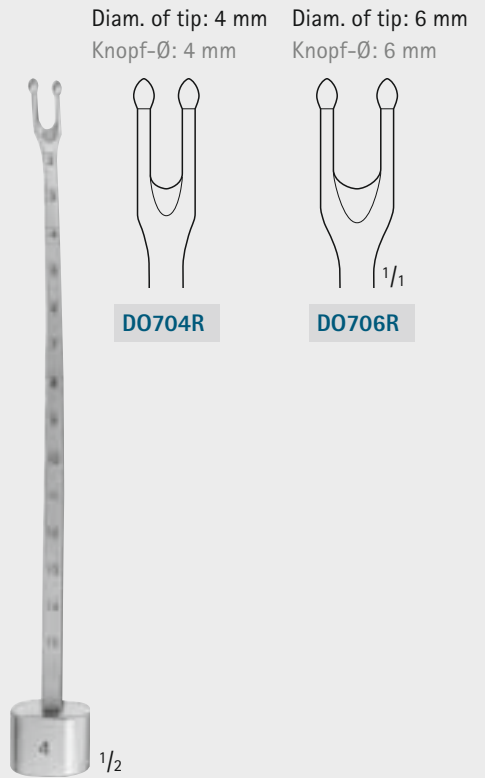

D0704R-D0706R

for septum
Nasenseptum-Osteotome
185 mm, 7 1/4"



CINELLI

OL326R-OL329R

double guarded
mit einseitig verrundeten Ecken
160 mm, 6 1/4"

Bone
Knochen

Bone Instruments – Knocheninstrumente

Chisels, Gouges, Osteotomes

Flach- und Hohlmeißel, Osteotome

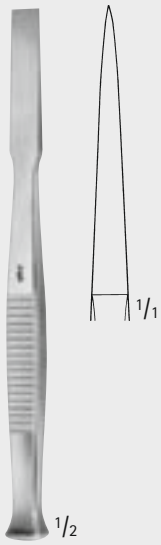

Art. No. Art. Nr.	Tip size Arbeitsende (mm)
----------------------	---------------------------------

FL110R	4
FL112R	6
FL114R	8
FL116R	10
FL118R	12
Osteotome	
Osteotom	
140 mm, 5 1/2"	

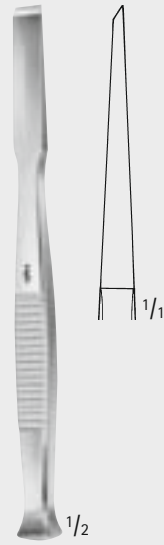

Art. No. Art. Nr.	Tip size Arbeitsende (mm)
----------------------	---------------------------------

FL120R	4
FL122R	6
FL124R	8
FL126R	10
FL128R	12
Chisel	
Flachmeißel	
140 mm, 5 1/2"	



GILLIES

Art. No. Art. Nr.	Tip size Arbeitsende (mm)
----------------------	---------------------------------

OL341R	5
OL342R	7
OL343R	9
Osteotome	
Osteotom	
140 mm, 5 1/2"	

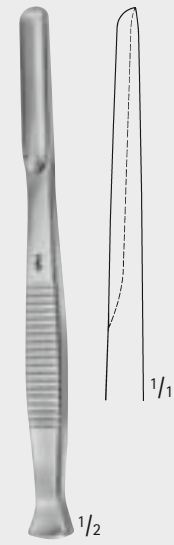

Art. No. Art. Nr.	Tip size Arbeitsende (mm)
----------------------	---------------------------------

FL130R	4
FL132R	6
FL134R	8
FL136R	10
FL138R	12
Gauge	
Hohlmeißel	
140 mm, 5 1/2"	



KILLIAN-CLAUS

OL335R

Septum gauge, with notch,
bayonet-shaped
Septum-Hohlmeißel, mit Kerbe,
bajonettförmig gebogen
170 mm, 6 3/4"

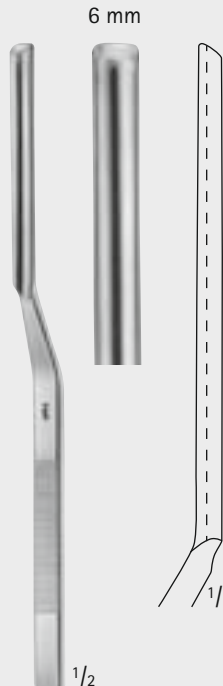

KILLIAN

OL336R

Septum gauge, round cutting edge,
bayonet-shaped
Septum-Hohlmeißel, mit runder Schneide,
bajonettförmig gebogen
170 mm, 6 3/4"

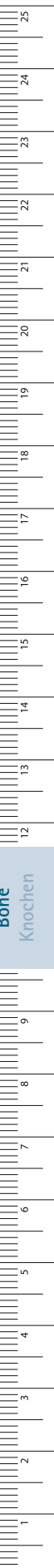

Bone
Knochen

MILLIMETERS

Bone Instruments – Knocheninstrumente

Chisels, Gouges, Osteotomes

Flach- und Hohlmeißel, Osteotome



PARTSCH

Art. No. Art. Nr.	Tip size Arbeitsende (mm)
FL173R	3
FL174R	4
FL175R	5
FL176R	6

Chisel
Flachmeißel
140 mm, 5 1/2"

PARTSCH

Art. No. Art. Nr.	Tip size Arbeitsende (mm)
FL183R	3
FL184R	4
FL185R	5
FL186R	6
FL187R	7

Chisel
Flachmeißel
170 mm, 6 3/4"

PARTSCH

Art. No. Art. Nr.	Tip size Arbeitsende (mm)
FL213R	3
FL214R	4
FL215R	5
FL216R	6

Gauge
Hohlmeißel
140 mm, 5 1/2"

PARTSCH

Art. No. Art. Nr.	Tip size Arbeitsende (mm)
FL223R	3
FL224R	4
FL225R	5
FL226R	6
FL227R	7

Gauge
Hohlmeißel
170 mm, 6 3/4"

TESSIER

Art. No. Art. Nr.	Tip size Arbeitsende (mm)
OL360R	2.5
OL361R	3.5
OL362R	5.0
OL366R	7.0
OL368R	10.0
OL370R	14.0
OL371R	18.0

Osteotome, straight
Osteotom, gerade
160 mm, 6 1/4"

TESSIER

Art. No. Art. Nr.	Tip size Arbeitsende (mm)
OL363R	5
OL367R	7
OL369R	10

Osteotome, curved
Osteotom, gebogen
160 mm, 6 1/4"

Bone
Knochen

Bone Instruments - Knocheninstrumente

Chisels, Gouges, Osteotomes

Flach- und Hohlmeißel, Osteotome

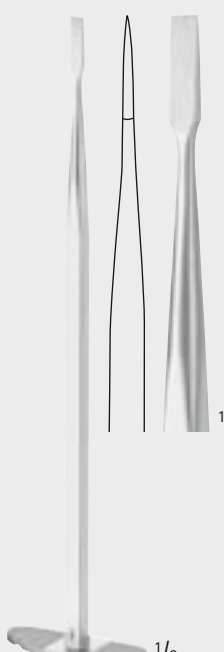

4 mm

1/1

1/2

DAUTREY
OL344R
Osteotome
Osteotom
170 mm, 6 3/4"

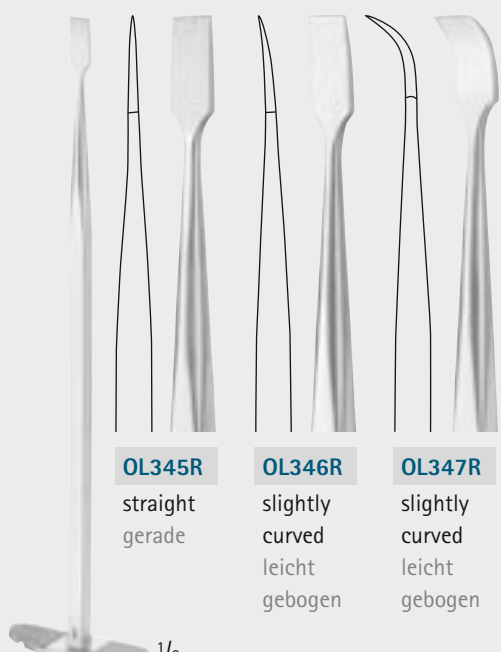

6 mm 6 mm 6 mm

1/1

1/2

OL345R straight gerade	OL346R slightly curved leicht gebogen	OL347R slightly curved leicht gebogen
-------------------------------------	--	--

DAUTREY
OL345R-OL347R
Osteotomes
Osteotome
170 mm, 6 3/4"

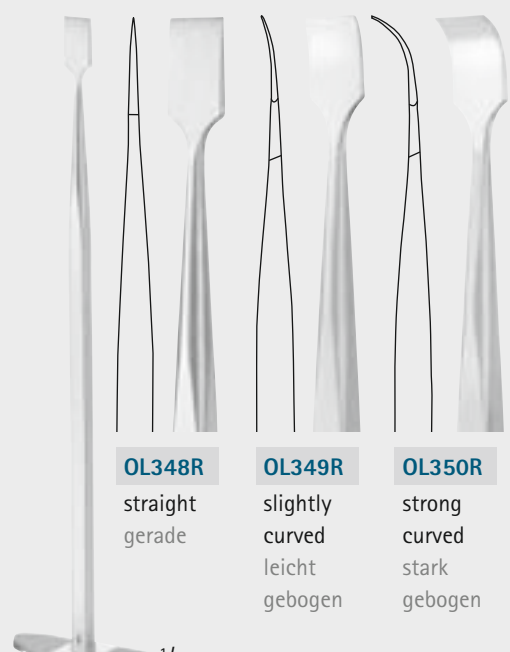

8 mm 8 mm 8 mm

1/1

1/2

OL348R straight gerade	OL349R slightly curved leicht gebogen	OL350R strong curved stark gebogen
-------------------------------------	--	---

DAUTREY
OL348R-OL350R
Osteotomes
Osteotome
170 mm, 6 3/4"



LUCAS

Art. No. Art. Nr.	Tip size Arbeitsende (mm)
DO711R	4
DO713R	6

Chisel
Flachmeißel
160 mm, 6 1/4"

1/1

1/2



LUCAS

Art. No. Art. Nr.	Tip size Arbeitsende (mm)
DO715R	3
DO717R	5

Gauge
Hohlmeißel
160 mm, 6 1/4"

1/1

1/2

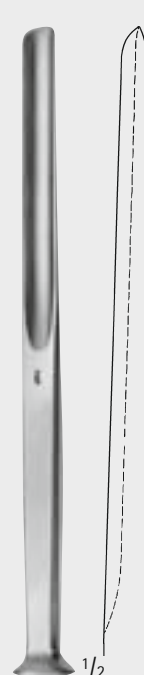

ALEXANDER

Art. No. Art. Nr.	Tip size Arbeitsende (mm)
FL343R	7
FL345R	9
FL347R	11

Gauge
Hohlmeißel
170 mm, 6 3/4"

1/1

1/2

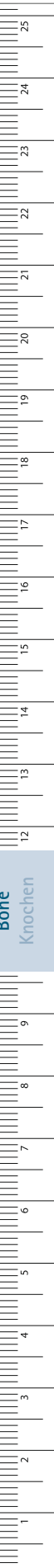

Bone
Knochen

Bone Instruments – Knocheninstrumente

Osteotomes

Osteotome

LAMBOTTE

Art. No. Art. Nr.	Tip size Arbeitsende (mm)
FL088R	2
FL089R	3
FL101R	4
FL102R	6
FL104R	8
FL106R	10
FL108R	12
FL109R	15

Osteotome
Osteotom
125 mm, 5"



COTTLE

Art. No. Art. Nr.	Tip size Arbeitsende (mm)
OL294R	4
OL296R	6
OL298R	8
OL299R	10
OL300R	12

Osteotome with depth markings
Osteotom mit Graduierung
180 mm, 7"

COTTLE

Art. No. Art. Nr.	Tip size Arbeitsende (mm)
OL301R	4
OL302R	7
OL303R	9
OL304R	12

Chisel-Osteotome with depth markings
Osteotom mit einseitigem Anschliff
und Graduierung
180 mm, 7"



COTTLE

Art. No. Art. Nr.	Tip size Arbeitsende (mm)
OL270R	2
OL271R	4
OL272R	6
OL273R	7
OL274R	9
OL275R	12

Osteotome with depth markings
and handle, straight
Osteotom mit Graduierung
und Griffbalken, gerade
180 mm, 7"

Bone Instruments – Knocheninstrumente

Chisels, Osteotomes

Flachmeißel, Osteotome

6 mm

1/1

1/2

COTTLE
OL305R

Osteotome with depth markings
Osteotom mit Graduierung
180 mm, 7"

8 mm

1/1

1/2

COTTLE
OL307R

Fishtail osteotom with protected ends
Fischschwanzosteotom
180 mm, 7"

3 mm

4.5 mm

1/1

1/2

WALTER
OL319R-OL320R

Chisel with notch, double graduated
Flachmeißel mit Hohlkehle, Spitzen verrundet
180 mm, 7"

2 mm

3 mm

4 mm

7 mm

9 mm

1/1

WALTER
OL390R-OL394R

Osteotomes
Osteotome
190 mm, 7 1/2"

11 mm

13 mm

14.5 mm

1/1

1/2

MC INDOE
OL331R-OL333R

Chisel with notch, double guarded
Meißel mit Hohlkehle, Spitzen verrundet
155 mm, 6 1/8"

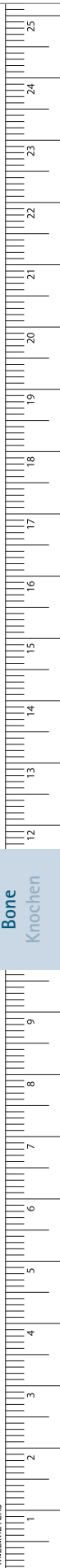

Bone Instruments – Knocheninstrumente

Chisels, Osteotomes

Flachmeißel, Osteotome



Bone
Knochen



EAST GRINSTEAD (WARD)

Art. No. Art. Nr.	Tip size Arbeitsende (mm)
D0722R	3
D0723R	5

Chisels
Flachmeißel
180 mm, 7"



EAST GRINSTEAD (WARD)

Art. No. Art. Nr.	Tip size Arbeitsende (mm)
D0732R	3
D0733R	5

Osteotome
Osteotom
180 mm, 7"



LAMBOTTE

Art. No. Art. Nr.	Tip size Arbeitsende (mm)
FL650R	4
FL651R	8
FL652R	10
FL653R	13
FL654R	15
FL655R	18
FL656R	20
FL658R	25
FL659R	30
FL660R	38
FL661R	44
FL662R	50

Osteotomes
Osteotome
245 mm, 9 5/8"



STILLE

Art. No. Art. Nr.	Tip size Arbeitsende (mm)
FL503R	10
FL504R	12
FL505R	15
FL506R	20
FL507R	25

Chisel
Flachmeißel
205 mm, 8"

Bone Instruments – Knocheninstrumente

Gouges, Osteotomes

Hohlmeißel, Osteotome

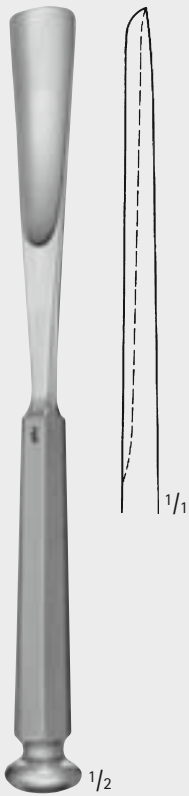

STILLE

Art. No. Art. Nr.	Tip size Arbeitsende (mm)
----------------------	---------------------------------

FL573R	10
FL574R	12
FL575R	15
FL576R	20
FL577R	25
Gauge Hohlmeißel 205 mm, 8"	

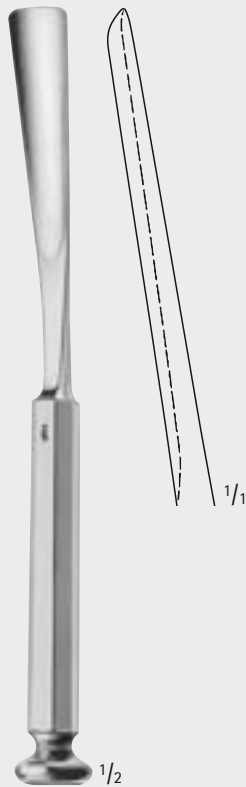

WALTER

Art. No. Art. Nr.	Tip size Arbeitsende (mm)
----------------------	---------------------------------

FL583R	10
FL585R	15
Gouges for taking grafts from the ribs Hohlmeißel zur Knorpel- entnahme aus der Rippe 205 mm, 8"	



STILLE

Art. No. Art. Nr.	Tip size Arbeitsende (mm)
----------------------	---------------------------------

FL512R	8
FL513R	10
FL514R	12
FL515R	15
FL516R	20
FL517R	25
Osteotomes Osteotome 205 mm, 8"	



STILLE

Art. No. Art. Nr.	Tip size Arbeitsende (mm)
----------------------	---------------------------------

FL523R	10
FL524R	12
FL525R	15
FL526R	20
FL527R	25
Osteotomes Osteotome 205 mm, 8"	

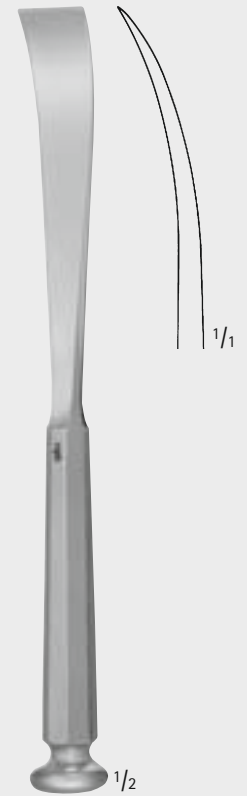

STILLE

Art. No. Art. Nr.	Tip size Arbeitsende (mm)
----------------------	---------------------------------

FL553R	10
FL554R	12
FL555R	15
FL556R	20
FL557R	25
Osteotomes, curved Osteotome, gebogen 205 mm, 8"	

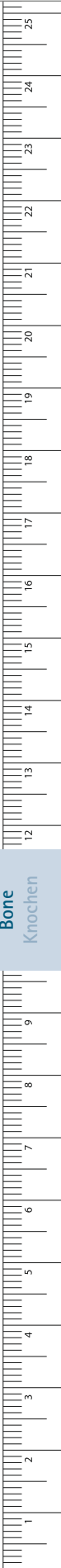

Bone Instruments – Knocheninstrumente

Chisels, Gouges, Osteotomes

Flach- und Hohlmeißel, Osteotome



Bone
Knochen



Art. No. Art. Nr.	Tip size Arbeitsende (mm)
D0750R	10
D0752R	15
D0754R	20

Chisel
Flachmeißel
200 mm, 7 7/8"



Art. No. Art. Nr.	Tip size Arbeitsende (mm)
D0751R	10
D0753R	15
D0755R	20

Chisel, curved
Flachmeißel, gebogen
200 mm, 7 7/8"



LEXER-MINI

Art. No. Art. Nr.	Tip size Arbeitsende (mm)
FL380R	4
FL381R	6
FL382R	8
FL383R	10
FL384R	12

Osteotome
Osteotom
180 mm, 7"



LEXER-MINI

Art. No. Art. Nr.	Tip size Arbeitsende (mm)
FL390R	4
FL391R	6
FL392R	8
FL393R	10
FL394R	12

Gauge
Hohlmeißel
180 mm, 7"

Bone Instruments – Knocheninstrumente

Gouges, Chisels, Osteotomes

Hohlmeißel, Meißel, Osteotome



LEXER

Art. No. Art. Nr.	Tip size Arbeitsende (mm)
----------------------	---------------------------------

FL401R	5
FL402R	7
FL403R	10
FL405R	15
FL406R	20
FL407R	25
FL408R	30

Osteotome
Osteotom
225 mm, 8 7/8"



LEXER

Art. No. Art. Nr.	Tip size Arbeitsende (mm)
----------------------	---------------------------------

FL411R	5
FL412R	7
FL413R	10
FL415R	15
FL416R	20
FL417R	25
FL418R	30

Gauge
Hohlmeißel
225 mm, 8 7/8"



OBWEGESER

Art. No. Art. Nr.	Tip size Arbeitsende (mm)
----------------------	---------------------------------

OL385R	8
OL386R	12
OL387R	16

Chisel, blunt
Meißel, stumpf
220 mm, 8 3/4"

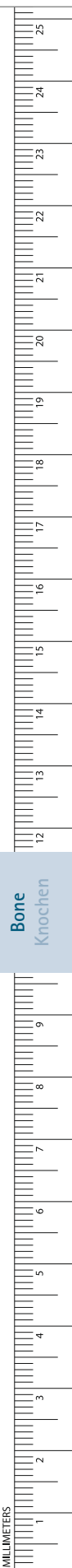

Bone Instruments – Knocheninstrumente

Sterilizable Grinding Stones

Sterilisierbare Schleifsteine

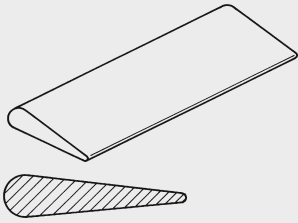

***DB090**

fine grain, feine Körnung

***DB091**

medium grain, mittlere Körnung
India Corund grinding stone, beige
for sharpening and pregrinding of very
blunt instruments

India-Korund-Schleifsteine, beige
zum Formen und Vorschleifen sehr
stumpfer Instrumente

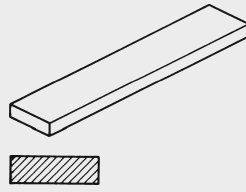

***DB095**

Original Arkansas grinding stone,
grey-white, for repeated grinding on
scalars and curettes as well as for
finishing

Original Arkansas-Schleifstein, grauweiß,
zum wiederholten Aufschleifen
sowie Finieren von Scalern und
Küretten

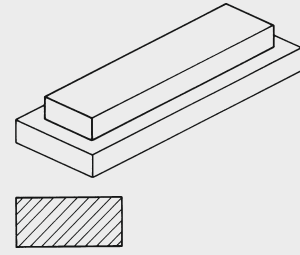

DB096

Super Arkansas grinding stone, white,
for repeated grinding on scalars and
curettes as well as for finishing
Stone in wooden case

Super-Arkansas-Schleifstein, weiß,
für das mehrmalige Aufschleifen und
Finieren von Scalern und Küretten
Stein im Holzetui

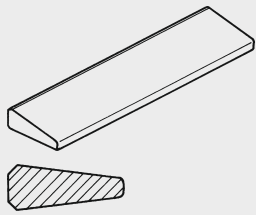

DB097

Super Arkansas grinding stone, white,
for repeated grinding on scalars and
curettes as well as for finishing

Super-Arkansas-Schleifstein, weiß
für das mehrmalige Aufschleifen und
Finieren von Scalern und Küretten

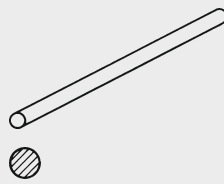

***DB098**

India Corund grinding stone, round
file, brown beige, for deburring the
working ends

100 mm, 4" long, diam. 6 mm
India-Korund-Schleifstein, Rundfeile,
braun-beige, zum Entgraten der
Federkanten
100 mm, 4" lang, Ø 6 mm

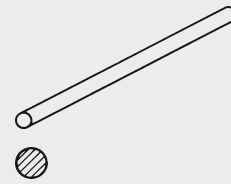

***DB086**

Plexiglas test rods, for checking
cutting effect of scalars and curettes.
Sales unit:

PAK = Package of 6 pieces
Plexiglas-Teststäbchen, zur Kontrolle
der Schneidewirkung von Scalern und
Küretten.

Bestelleinheit:
PAK = Packung à 6 Stück



***JG598**

Sterilit®, Aesculap oil for grinding
stones

Contents: 50 ccm

Sterilit®, Aesculap-Schleifstein-Öl
Inhalt: 50 ccm

- Items marked * are necessary for the basic equipment
- Die mit * gekennzeichneten Artikel: als Grundausrüstung erforderlich

Bone Instruments – Knocheninstrumente

Mallets Hämmer

- Weights refer to the head / total weight of the mallets
- Die Gewichtsangaben beziehen sich auf das Kopf- / Gesamtgewicht des jeweiligen Hammers



Diam. 20 mm
Ø 20 mm

FL034
Pair of spare discs
Ersatzbackenpaar

1/2

MEAD

FL035R 160 g / 350 g
with interchangeable
plastic discs
mit auswechselbaren
Kunststoffbacken
190 mm, 7 1/2"

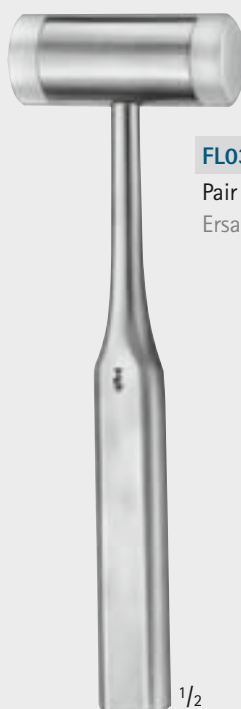

Diam. 25 mm
Ø 25 mm

FL037
Pair of spare discs
Ersatzbackenpaar

1/2

FL036R 135 g / 210 g
with interchangeable
plastic discs
mit auswechselbaren
Kunststoffbacken
185 mm, 7 1/4"



COTTLE

FL038R 235 g / 320 g
1 side flat,
1 side convex
1 Seite flach,
1 Seite konvex
185 mm, 7 1/4"

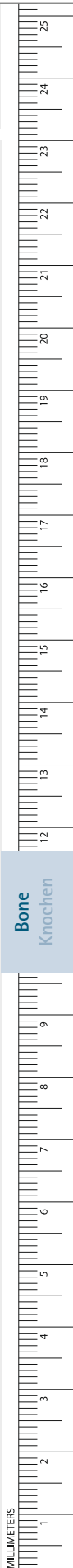

Bone
Knochen

MILLIMETERS

Bone Instruments – Knocheninstrumente

Mallets

Hämmer

- Weights refer to the head / total weight of the mallets
- Die Gewichtsangaben beziehen sich auf das Kopf- / Gesamtgewicht des jeweiligen Hammers



Bone
Knochen



FLO39R 130 g / 235 g
with one smooth and
one rough surface
mit einer flachen und
einer aufgerauhten Fläche
185 mm, 7 1/4"



DF112R 80 g / 165 g
165 mm, 6 1/2"

■ ERGOPLANT



DX545R 135 g / 415 g
with interchangeable
plastic discs
mit auswechselbaren
Kunststoffbacken
200 mm, 7 7/8"

Bone Instruments – Knocheninstrumente

Mallets

Hämmer



FL045R 200 g / 340 g
with interchangeable
plastic discs
mit auswechselbaren
Kunststoffbacken
235 mm, 9 1/4"



DF114R 155 g / 220 g
190 mm, 7 1/2"



HAJEK
FL044R 140 g / 210 g
220 mm, 8 3/4"

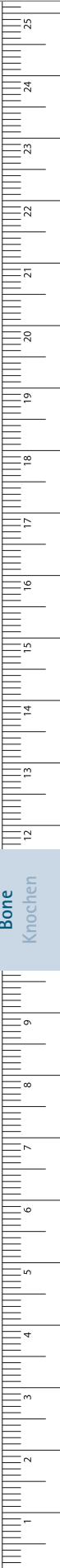

Bone Instruments – Knocheninstrumente

Tampers

Stößel



FL097R **FL098R**

 2.5 mm 3.5 mm

1/2

PASSOW

FL097R-FL098R

120 mm, 4 3/4"

FL093R **FL094R** **FL095R** **FL096R**

 Diam. / Ø 3 mm 5 mm 7 mm 9 mm

1/2

FL093R-FL096R

160 mm, 6 1/4"

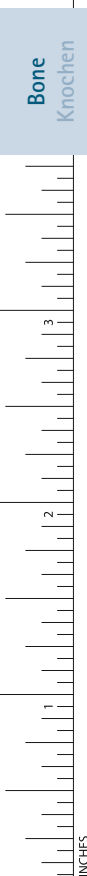

Bone
Knochen

FF913R **FF914R** **FF915R**

 Diam. / Ø 3 mm 5 mm 8 mm

1/2

CASPAR

FF913R-FF915R

200 mm, 7 7/8"

Bone Instruments - Knocheninstrumente

Awls
Ahlen

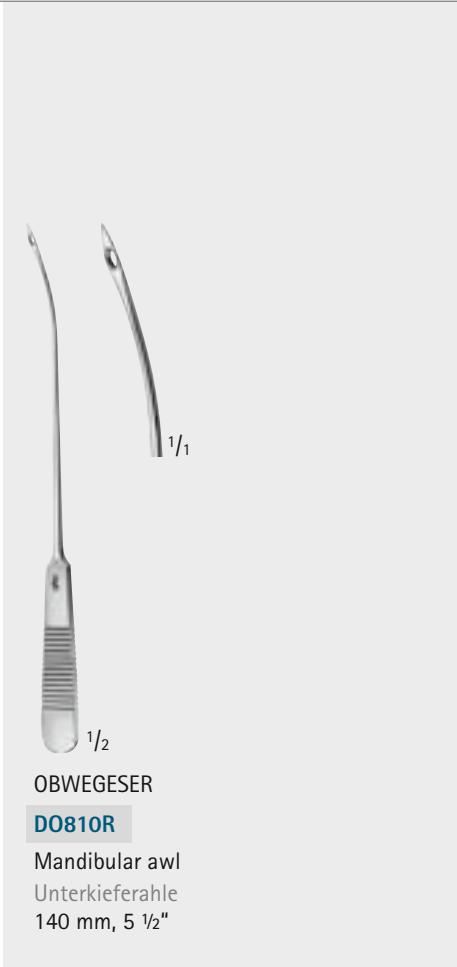

OBWEGESER
DO810R
Mandibular awl
Unterkieferahle
140 mm, 5 1/2"

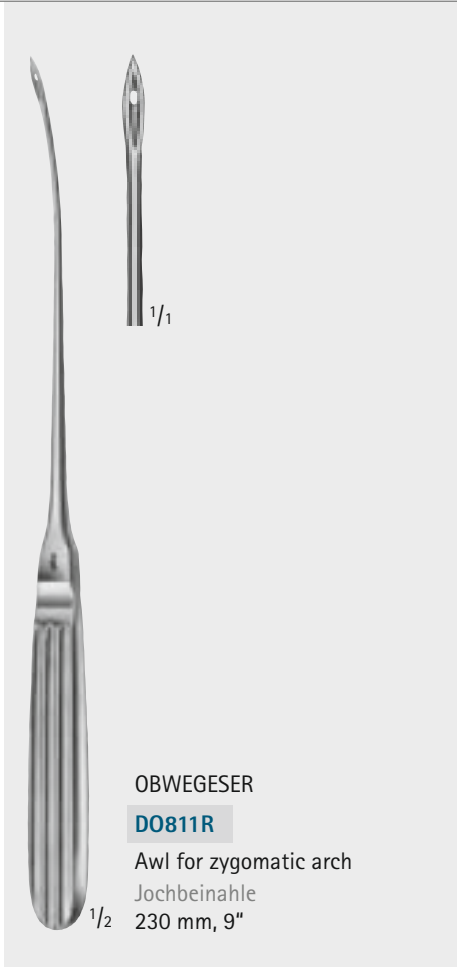

OBWEGESER
DO811R
Awl for zygomatic arch
Jochbeinahle
230 mm, 9"

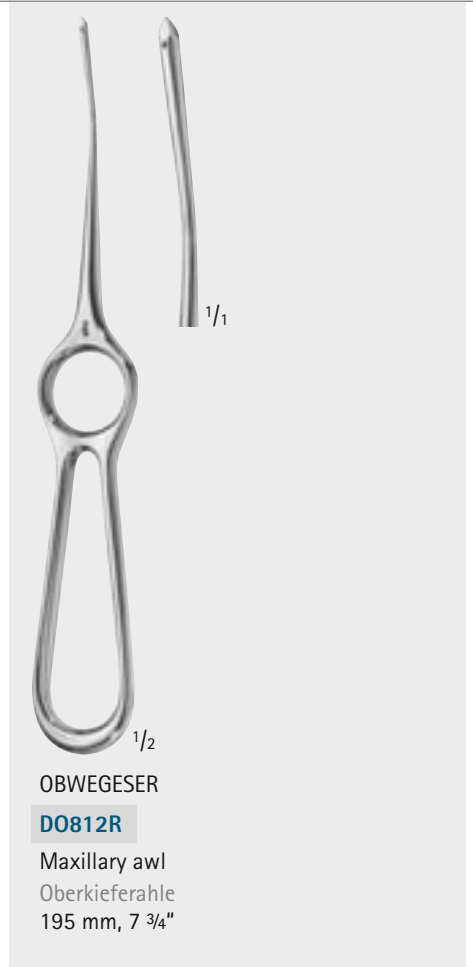

OBWEGESER
DO812R
Maxillary awl
Oberkieferahle
195 mm, 7 3/4"

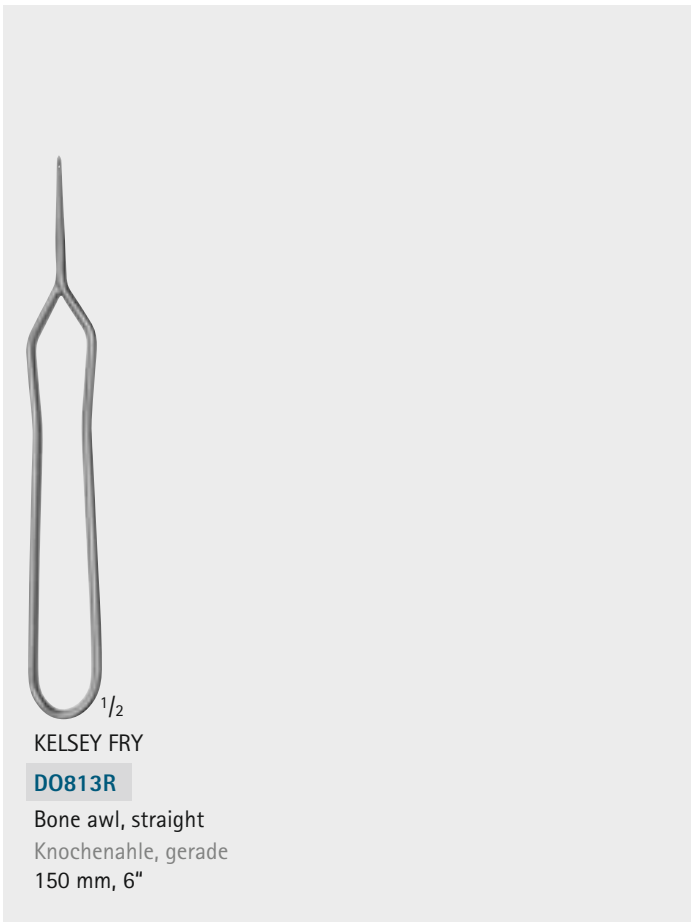

KELSEY FRY
DO813R
Bone awl, straight
Knochenahle, gerade
150 mm, 6"

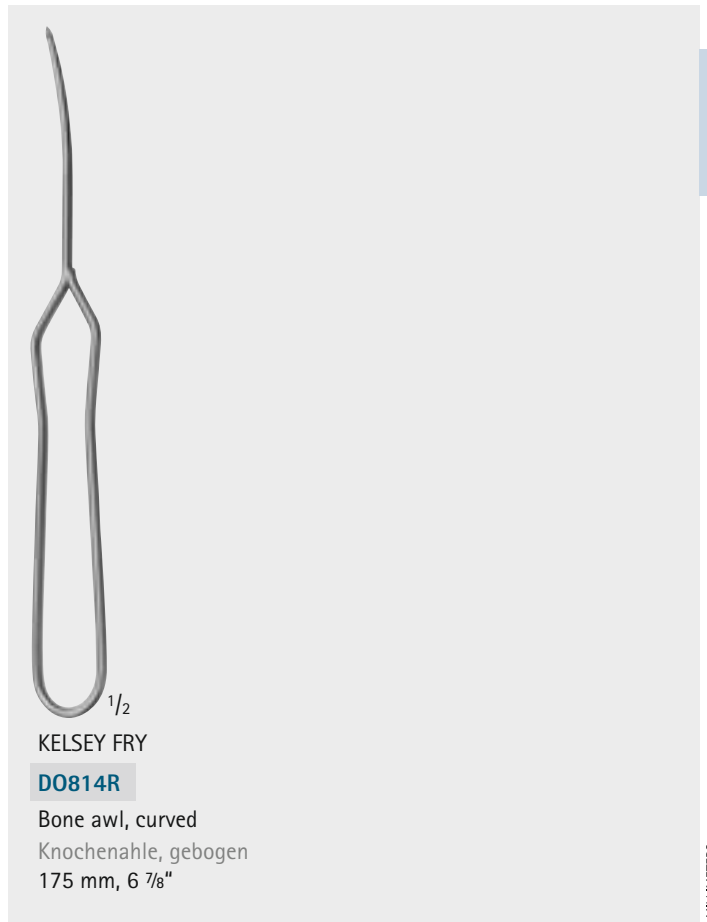

KELSEY FRY
DO814R
Bone awl, curved
Knochenahle, gebogen
175 mm, 6 7/8"

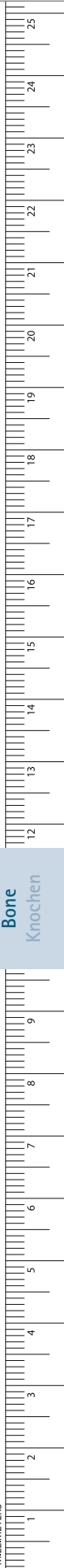

Bone Instruments – Knocheninstrumente

Bone Files and Rasps

Knochen-Feilen und -Raspeln

7.5 mm
9 mm

OL401R
fine, chequered
kariert, fein

OL403R
coarse, chequered
kariert, grob

JOSEPH
OL401R-OL403R
165 mm, 6 1/2"



8 mm
8 mm

OL408R
fine teeth
feine Zahnung

OL409R
coarse teeth
grobe Zahnung

LEWIS
OL408R-OL409R
175 mm, 6 7/8"

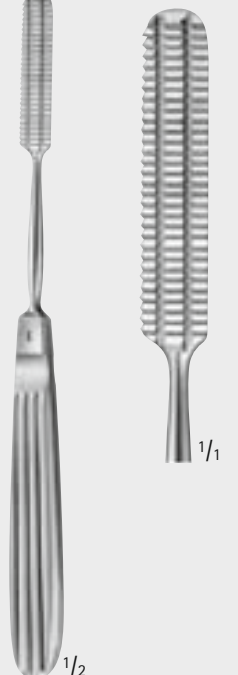

9 mm

MALTZ
OL407R
down stroke
auf Zug
165 mm, 6 1/2"

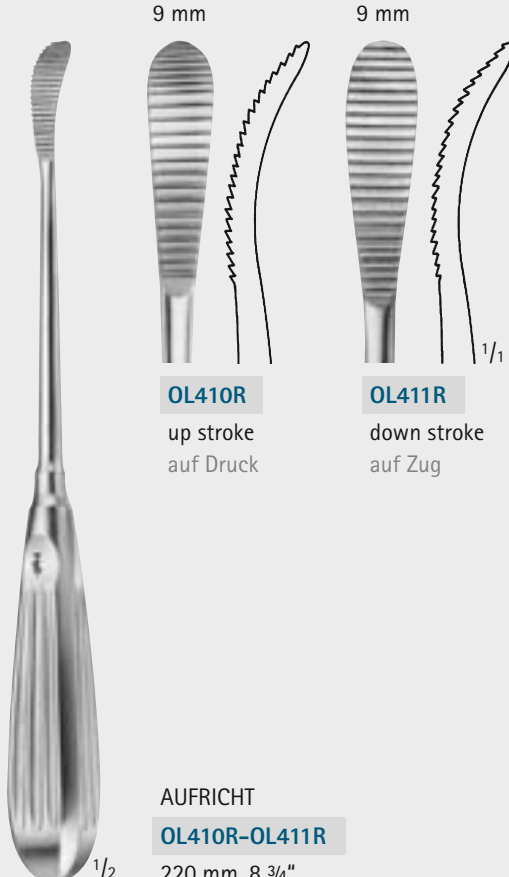

9 mm
9 mm

OL410R
up stroke
auf Druck

OL411R
down stroke
auf Zug

AUFRICHT
OL410R-OL411R
220 mm, 8 3/4"



6.5 mm

GALLAHER
OL412R
190 mm, 7 1/2"



7 mm

OL413R
Diamond rasp,
straight
Diamant Raspel,
gerade
180 mm, 7"

Bone Instruments - Knocheninstrumente

Bone Files and Rasps

Knochen-Feilen und -Raspeln

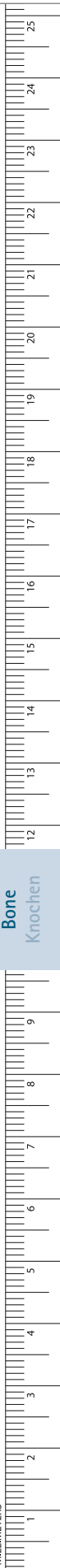
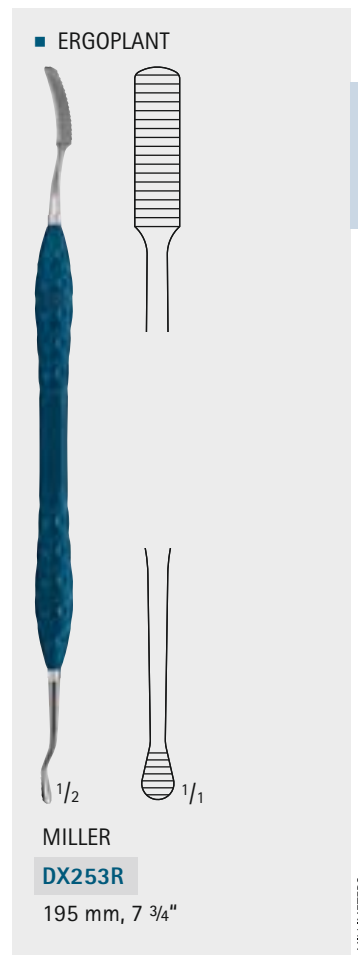
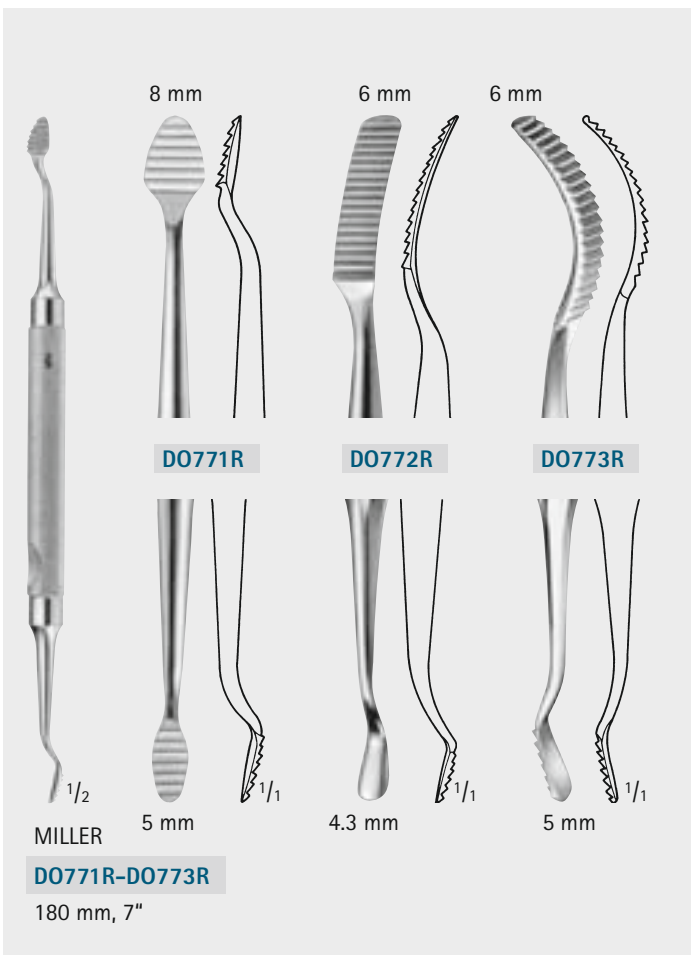
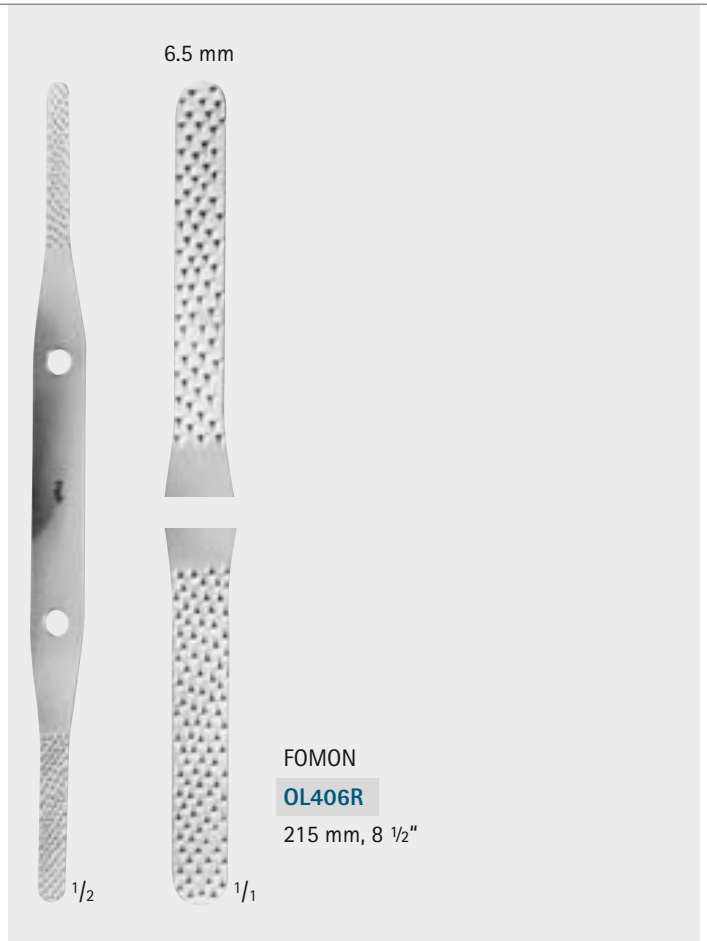
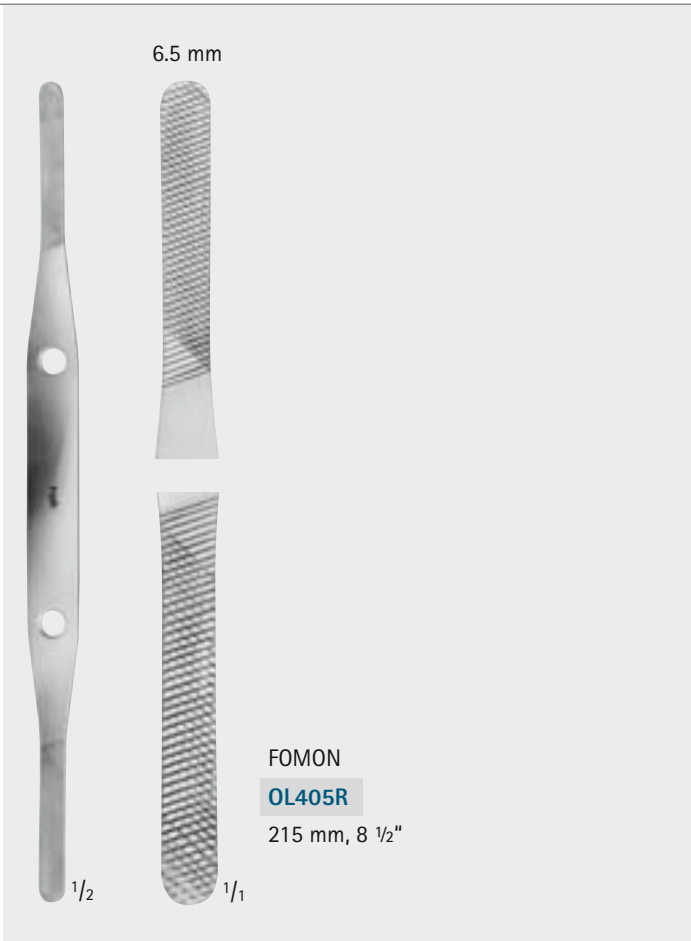

Bone Instruments – Knocheninstrumente

DUROGRIP® Rasps

DUROGRIP® Raspeln

DUROGRIP® double-ended rasps with tungsten carbide inserts

- Identification: gold-plated handle
- Profile in 10 different fine graduations
- Sharp rasp profile allows progressive removal
- Tungsten carbide inserts guarantee permanent sharpness and long life span

DUROGRIP® Raspeln mit Hartmetall-Plättchen

- Kennzeichnung: Vergoldeter Griff
- Profil in 10 verschiedenen Feinabstufungen
- Scharfes Raspelprofil ermöglicht progressives Abtragen
- Die Hartmetall-Plättchen gewähren kontinuierliche Schärfe und Lebensdauer



Bone
Knochen

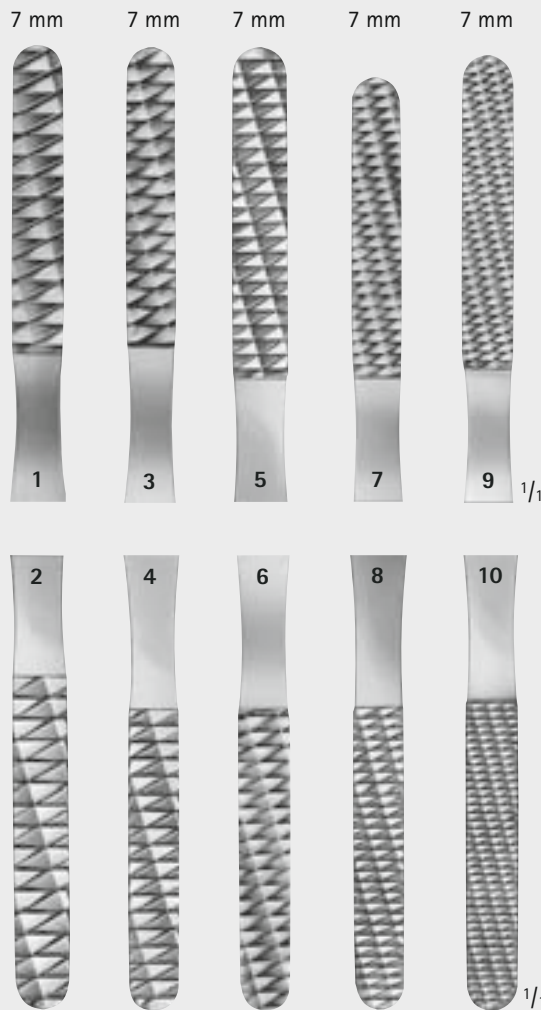

OL421R-OL429R

210 mm, 8 1/4"

Teeth/Zähne

OL421R

12/14

OL423R

16/20

OL425R

24/30

OL427R

36/44

OL429R

52/62

Bone Instruments – Knocheninstrumente

Bone Rongeurs

Hohlmeißelzangen

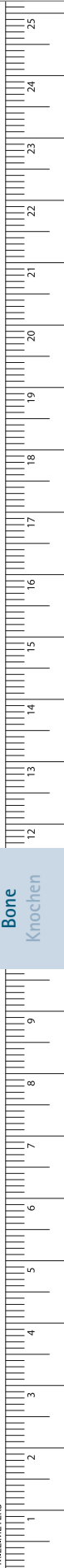
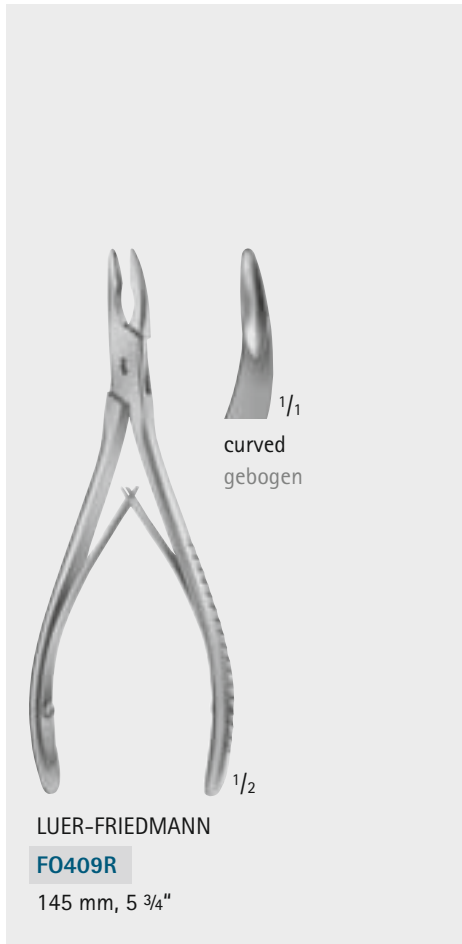
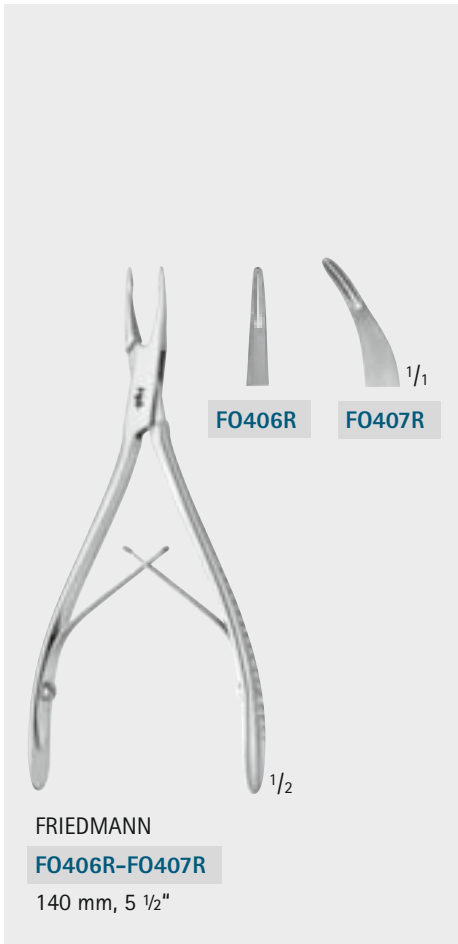
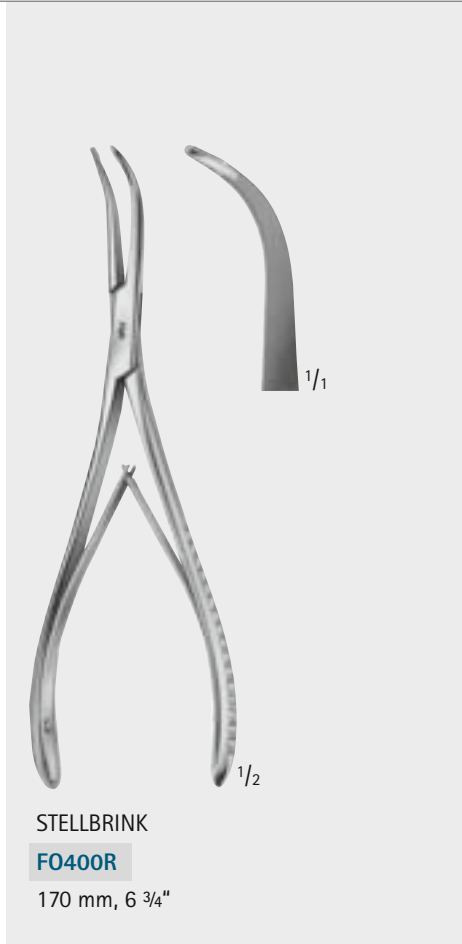
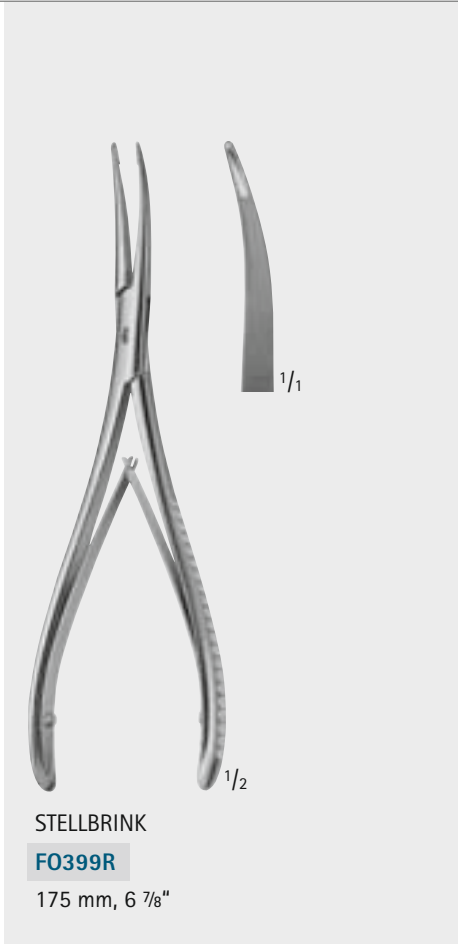
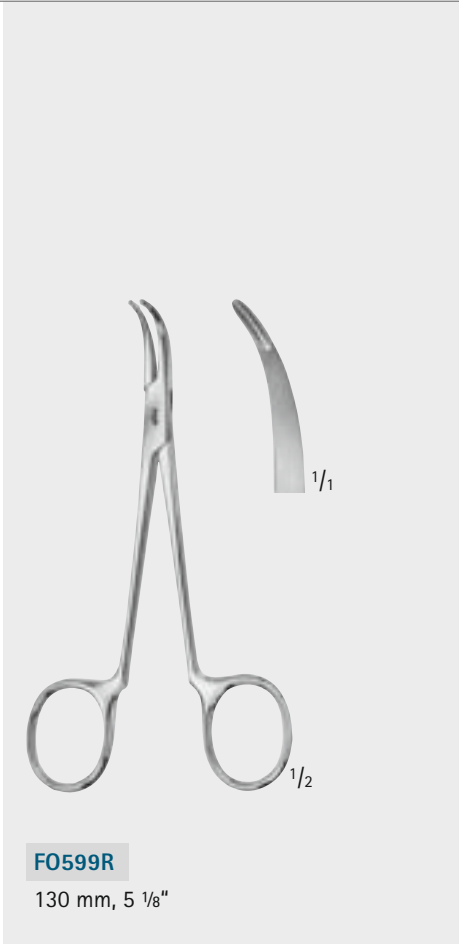

Bone Instruments – Knocheninstrumente

Bone Rongeurs

Hohlmeißelzangen

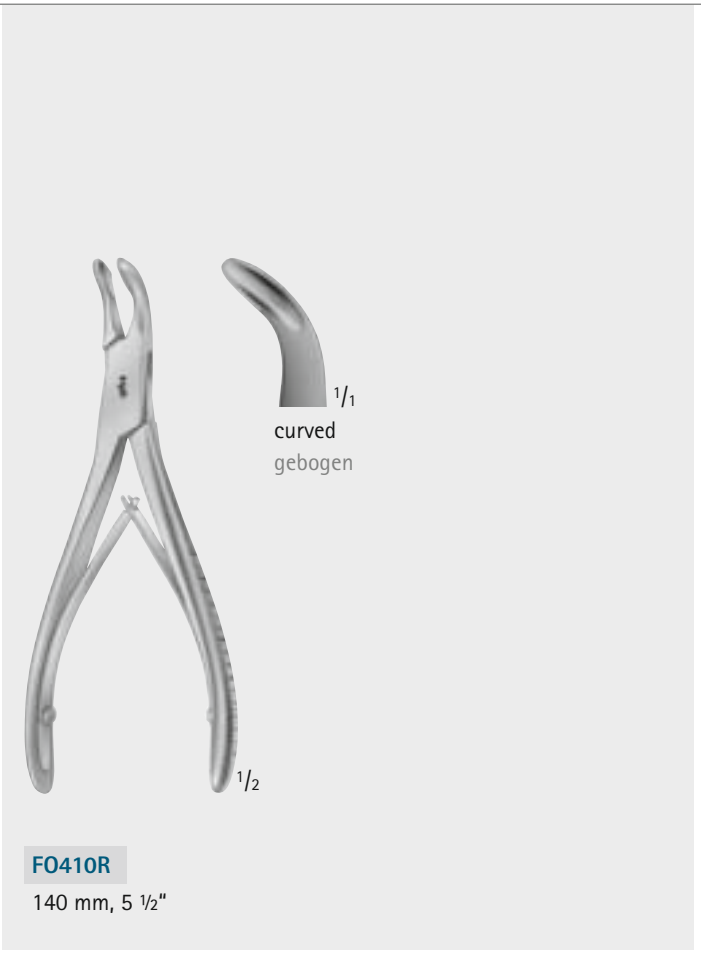

Bone
Knochen

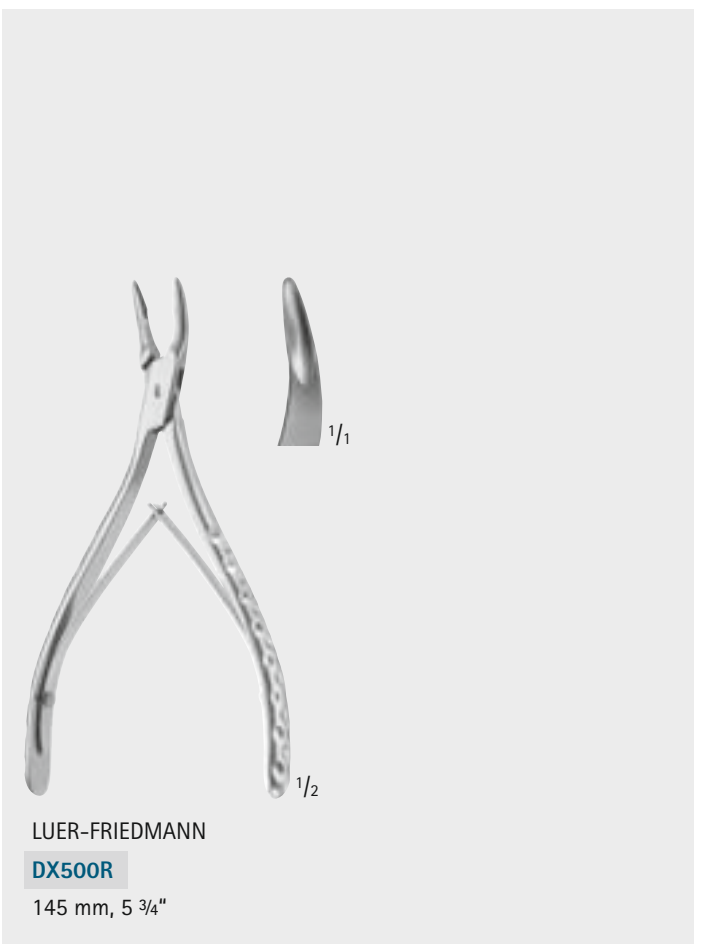
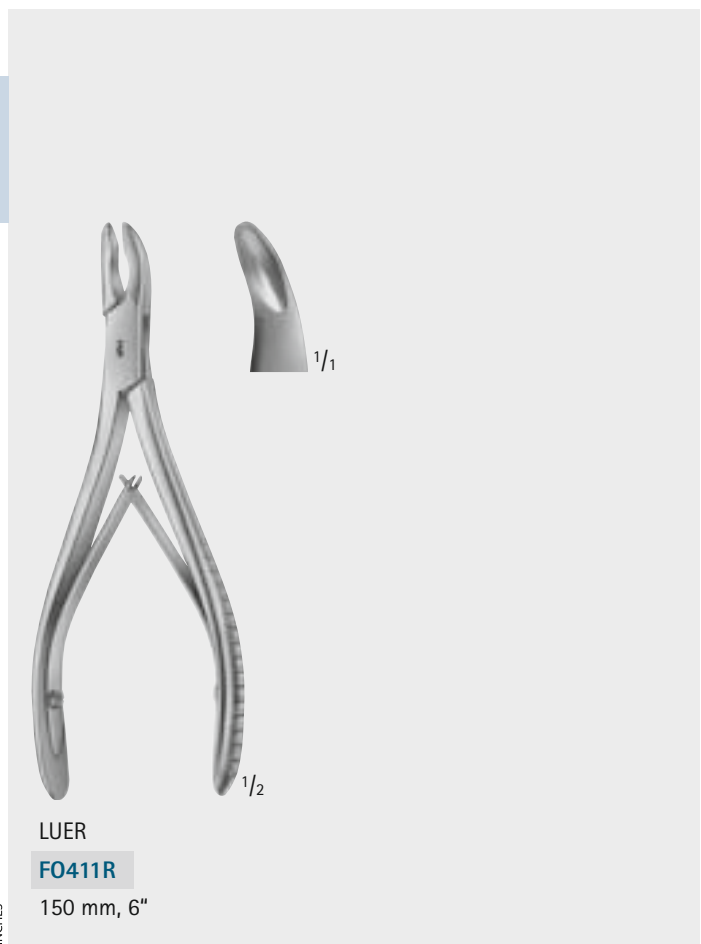
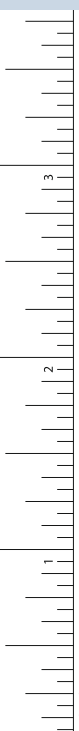

Bone Instruments - Knocheninstrumente

Bone Rongeurs

Hohlmeißelzangen



LUER
FO412R
155 mm, 6 1/8"

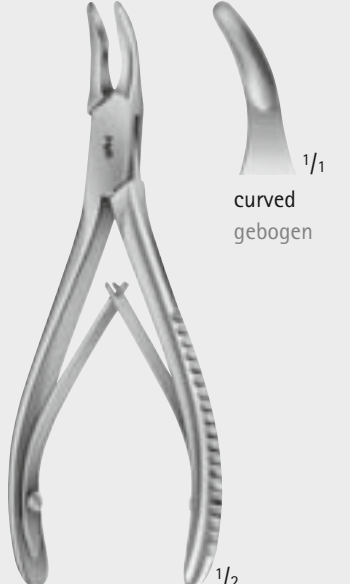

BLUMENTHAL
FO415R
155 mm, 6 1/8"



BLUMENTHAL
FO416R
150 mm, 6"

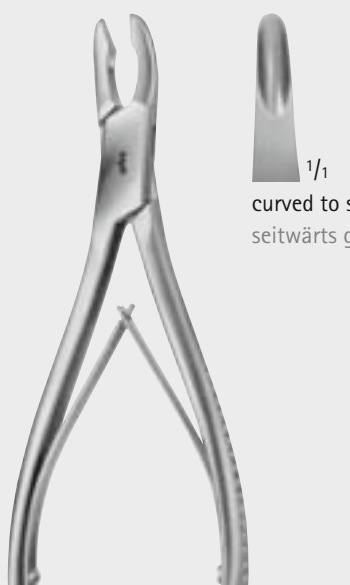

HAKANSSON
FO428R
170 mm, 6 3/4"



JANSEN
FO430R-FO432R
175 mm, 6 7/8"



BANE-HARTMANN
FO457R
175 mm, 6 7/8"

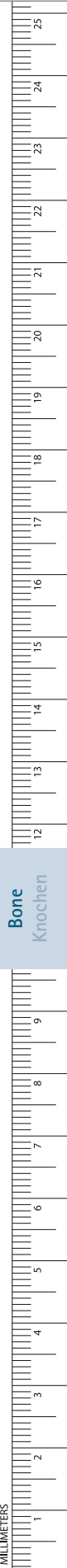

Bone Instruments – Knocheninstrumente

Bone Rongeurs

Hohlmeißelzangen



ALEXANDER
FO440R
140 mm, 5 1/2"

JANSEN
FO442R
190 mm, 7 1/2"

s-shaped
S-förmig

LEMPERT
MD617
155 mm, 6 1/8"

LEMPERT
FO450R-FO451R
200 mm, 7 7/8"

BEYER
FO453R
180 mm, 7"

curved
gebogen

MEAD
FO455R
165 mm, 6 1/2"

curved
gebogen

Bone Instruments - Knocheninstrumente

Bone Rongeurs

Hohlmeißelzangen



Two views of the Böhler Bone Rongeurs: a full view and a close-up of the beak. The beak is labeled with a 1/1 ratio. The full view is labeled with a 1/2 ratio.

FO500R **FO502R**

BÖHLER
FO500R-FO502R
155 mm, 6 1/8"



Two views of the Mayfield Bone Rongeurs: a full view and a close-up of the beak. The beak is labeled with a 1/1 ratio. The full view is labeled with a 1/2 ratio.

FO511R

MAYFIELD
FO511R
175 mm, 6 7/8"



Two views of the Marquardt Bone Rongeurs: a full view and a close-up of the beak. The beak is labeled with a 1/1 ratio. The full view is labeled with a 1/2 ratio.

FO520R

MARQUARDT
FO520R
200 mm, 7 7/8"



Two views of the Beyer and Zaufal-Jansen Bone Rongeurs: a full view and a close-up of the beak. The beak is labeled with a 1/1 ratio. The full view is labeled with a 1/2 ratio.

BEYER **ZAUFAL-JANSEN**
FO514R **FO515R**

BEYER
FO514R-FO515R
180 mm, 7"



Two views of the Ruskin Bone Rongeurs: a full view and a close-up of the beak. The beak is labeled with a 1/1 ratio. The full view is labeled with a 1/2 ratio.

FO518R

RUSKIN
FO518R
190 mm, 7 1/2"

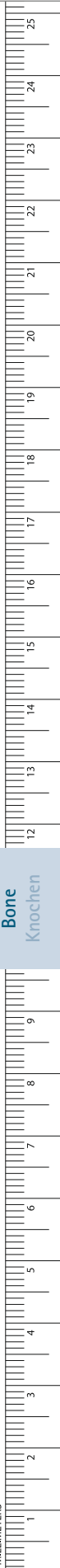

Bone Instruments – Knocheninstrumente

Bone Cutting Forceps

Knochensplitterzangen



FO601R
130 mm, 5 1/8"

DX501R
130 mm, 5 1/8"

STAMM
FO604R
150 mm, 6"

FO602R
170 mm, 6 3/4"

KAZANJIAN
OK378R
185 mm, 7 1/4"

Bone
Knochen

Bone Instruments – Knocheninstrumente

Bone Cutting Forceps, Bone Shears

Knochensplitterzangen, Knochenscheren

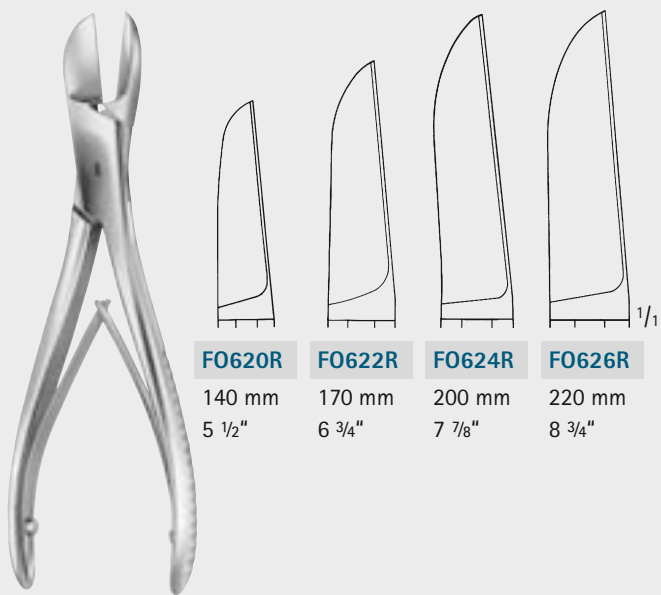

FO620R 140 mm 5 1/2"
FO622R 170 mm 6 3/4"
FO624R 200 mm 7 7/8"
FO626R 220 mm 8 3/4"

LISTON
FO620R-FO626R
 Bone cutting forceps
 Knochensplitterzangen

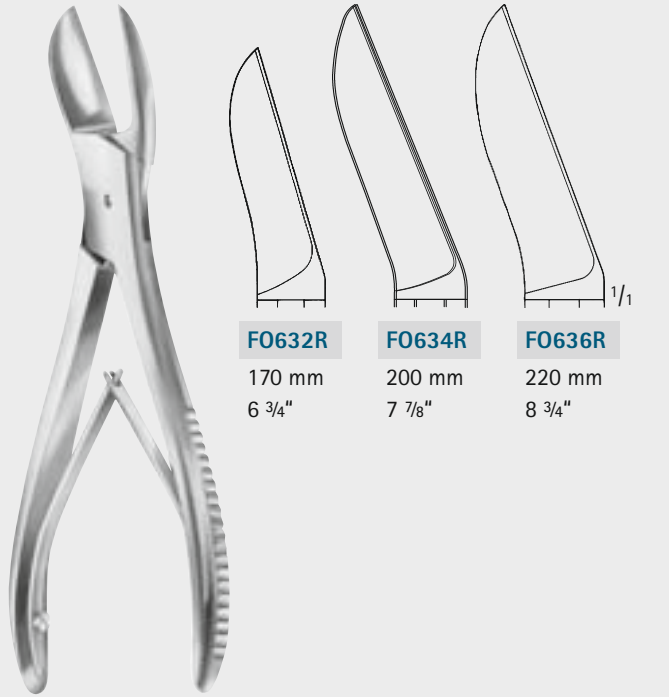

FO632R 170 mm 6 3/4"
FO634R 200 mm 7 7/8"
FO636R 220 mm 8 3/4"

LISTON
FO632R-FO636R
 Bone cutting forceps
 Knochensplitterzangen

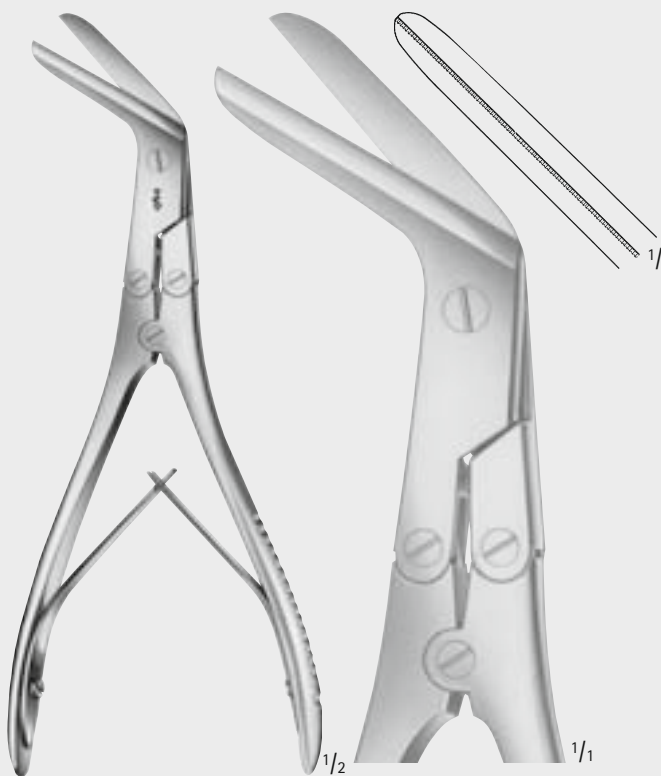

KILLIAN
OP130R
 Bone shear, double action
 Knochenschere, doppelt übersetzt
 200 mm, 7 7/8"



MÜHLING
F0216R
 Bone shear, double action
 Knochenschere, doppelt übersetzt
 210 mm, 8 1/4"

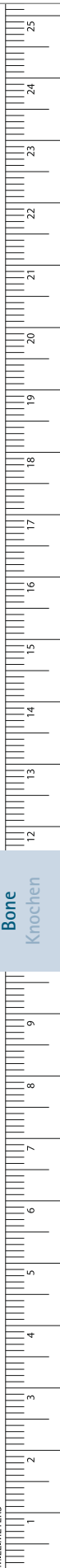

Bone Instruments – Knocheninstrumente

Bone Cutting Forceps

Knochensplitterzangen



BÖHLER
FO610R
145 mm, 5 3/4"

BÖHLER
FO611R
145 mm, 5 3/4"

FO612R
170 mm, 6 3/4"

MC INDOE
FO614R
175 mm, 6 7/8"

RUSKIN-LISTON
FO640R
190 mm, 7 1/2"

RUSKIN-LISTON
FO641R
190 mm, 7 1/2"

Bone
Knochen

Bone Instruments – Knocheninstrumente

Rib Shears

Rippenscheren



FB870R

230 mm, 9"



GLUCK

FB873R

190 mm, 7 1/2"



GIERTZ-STILLE

FB890R

250 mm, 9 3/4"



SAUERBRUCH

FB881R

for children
für Kinder
240 mm, 9 1/2"

SAUERBRUCH

FB882R

for adults
für Erwachsene
270 mm, 10 5/8"

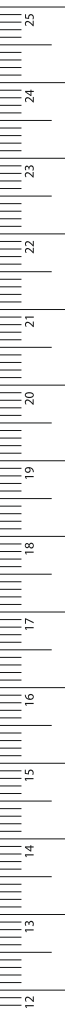

Bone
Knochen

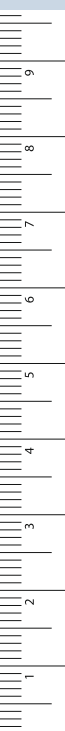

Bone Instruments – Knocheninstrumente

Bone Holding Forceps

Knochenhaltezangen



5 mm
M_{1/1}

FO120R
200 mm, 7 7/8"

1/2

Detailed description: A pair of long-handled bone holding forceps with a 5 mm jaw opening. The jaws are curved and feature serrated inner surfaces. The handles are long and taper towards the ends.

STRICKER
DX601R
135 mm, 5 1/4"

1/2

Detailed description: A pair of bone holding forceps with a 5 mm jaw opening. The jaws are straight and feature serrated inner surfaces. The handles are shorter and have circular finger loops.

11 mm
M_{1/1}

LANGENBECK
FO127R
205 mm, 8"

1/2

Detailed description: A pair of long-handled bone holding forceps with an 11 mm jaw opening. The jaws are curved and feature serrated inner surfaces. The handles are long and taper towards the ends.

12 mm
M_{1/1}

FERGUSON
FO130R
205 mm, 8"

1/2

Detailed description: A pair of long-handled bone holding forceps with a 12 mm jaw opening. The jaws are curved and feature serrated inner surfaces. The handles are long and taper towards the ends.

Bone
Knochen

Bone Instruments - Knocheninstrumente

Bone Holding Forceps

Knochenhaltezangen

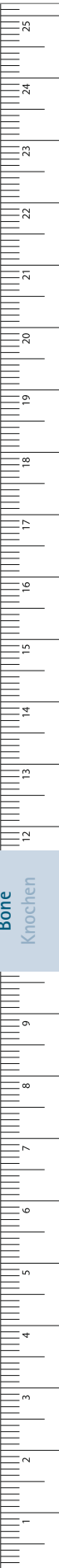
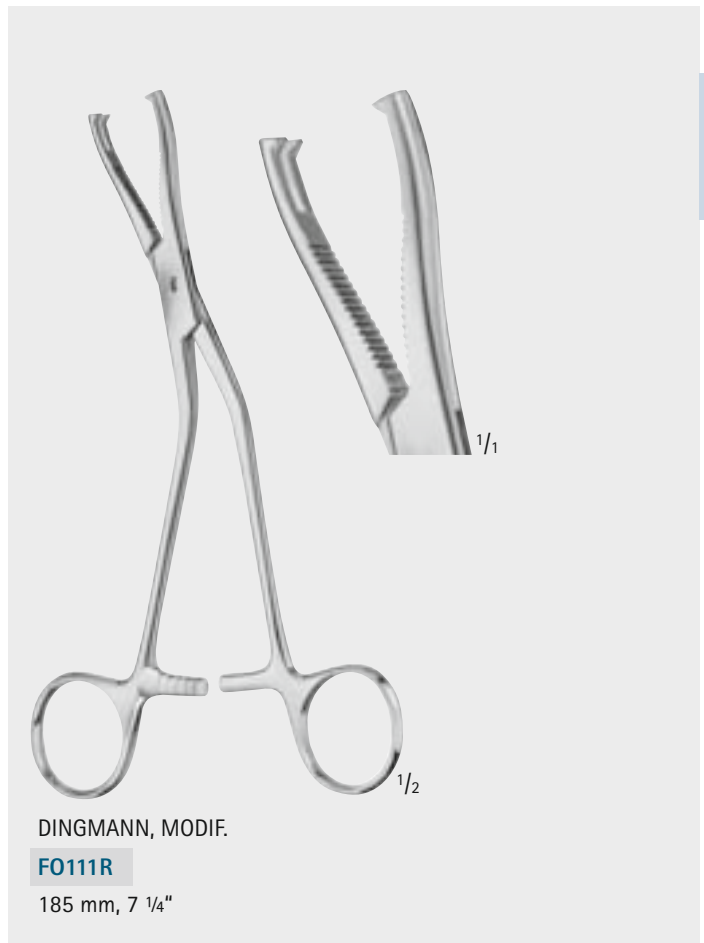
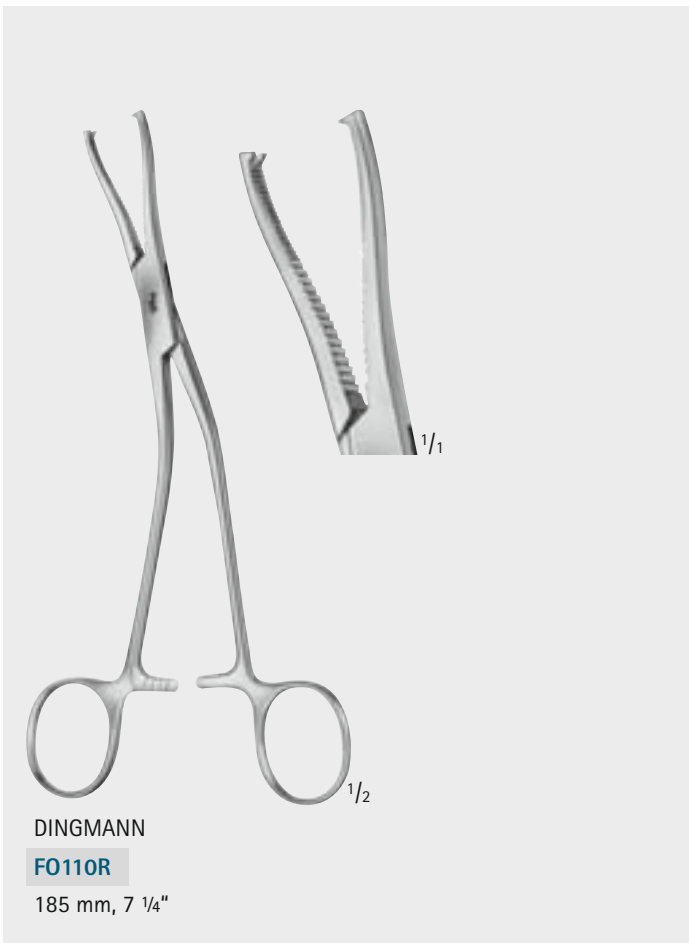
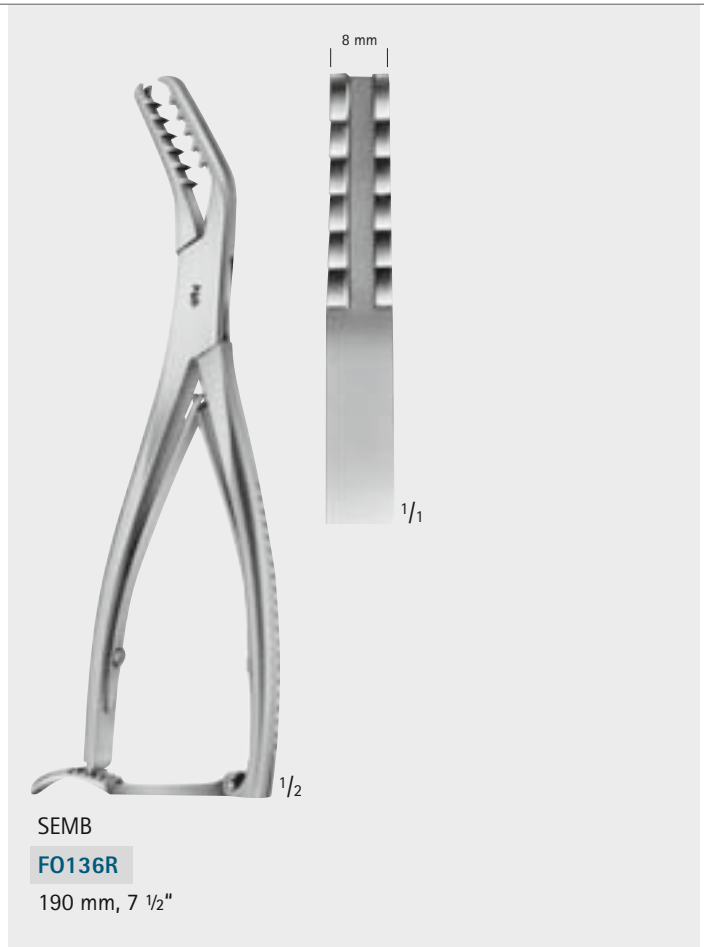
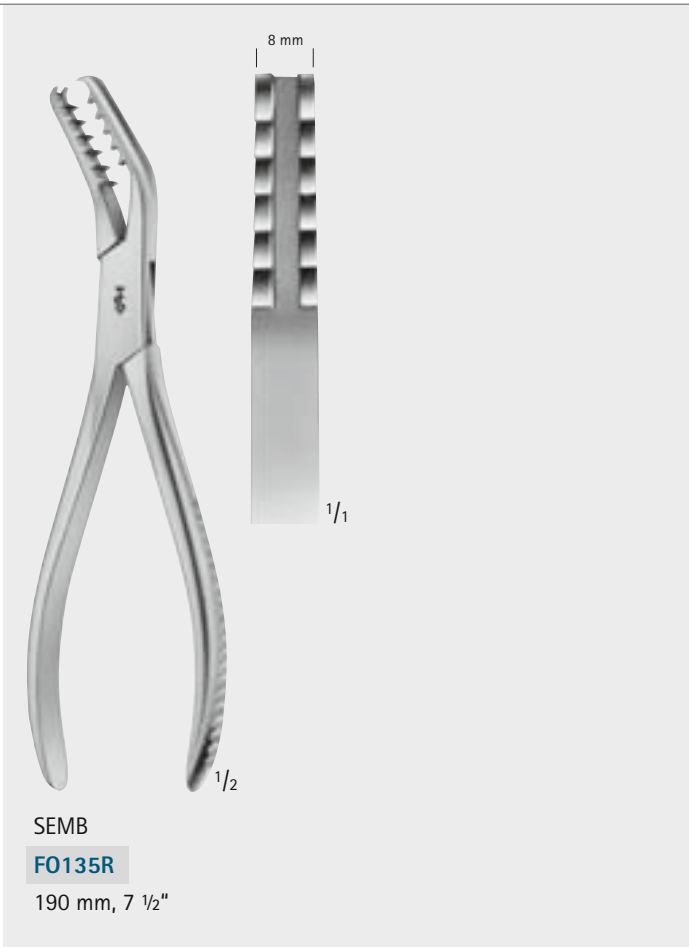

Bone Instruments – Knocheninstrumente

Reposition Forceps

Repositionszangen

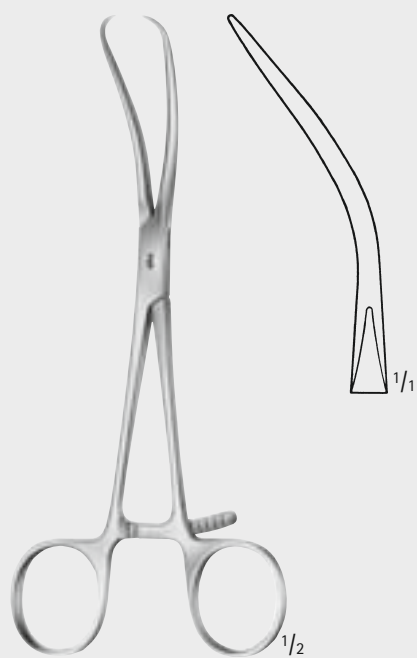

REILL

FO116R

170 mm, 6 3/4"



FO118R

205 mm, 8"

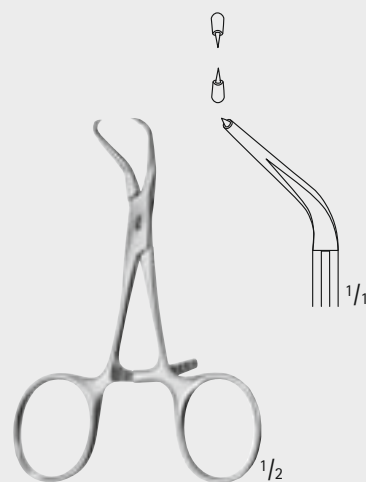

FO113R

with stepped tips
mit abgesetzten Spitzen
95 mm, 3 3/4"

Bone
Knochen

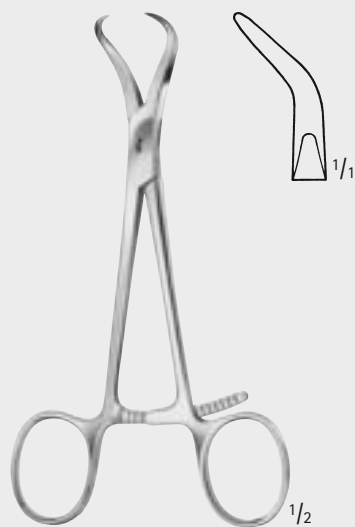

FO115R

for small fragments
für Kleinfragmente
135 mm, 5 1/4"

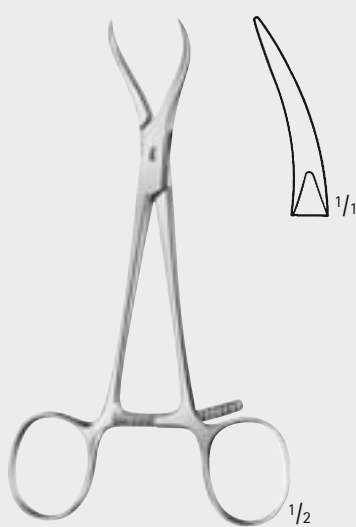

FO117R

especially for maxillary reposition
speziell für Kieferrepositionen
135 mm, 5 1/4"

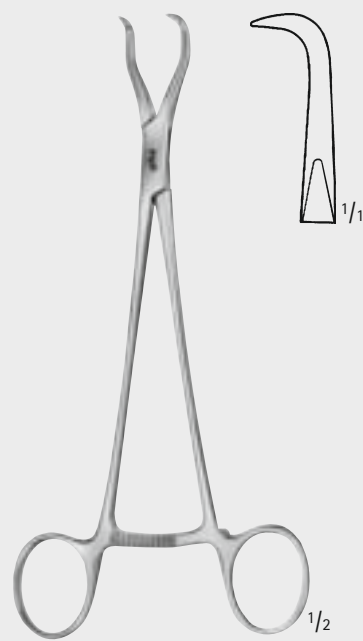

HAASE

FO119R

for mandibular fractures
für Unterkieferfrakturen
165 mm, 6 1/2"

Bone Instruments – Knocheninstrumente

Bone Punches Knochenstanzen

- Angled positions for punches
- Winkelstellungen bei Stanzen

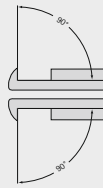

90° upwards cutting
nach oben schneidend

65 mm, 2 1/2"

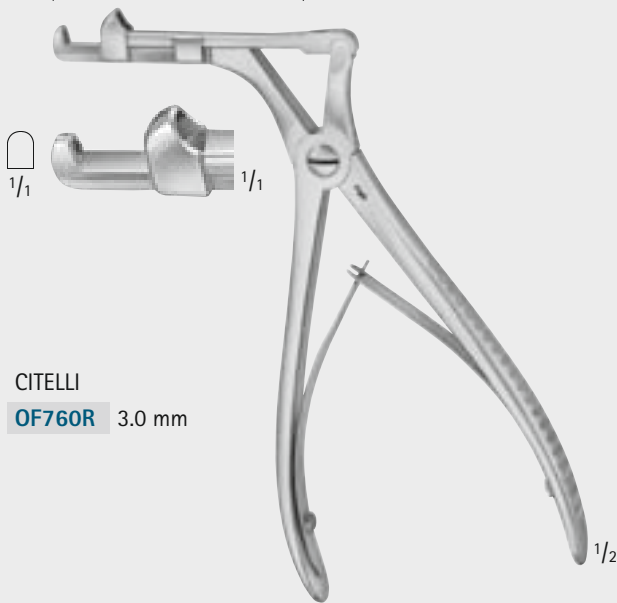

CITELLI
OF760R 3.0 mm

90° upwards cutting
nach oben schneidend

95 mm, 3 3/4"

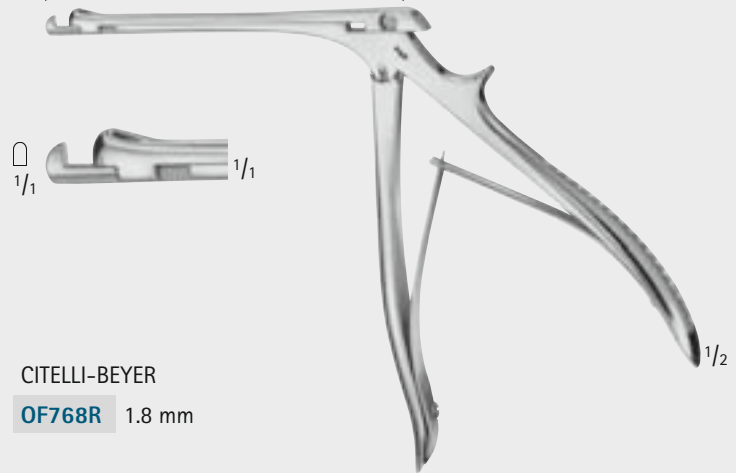

CITELLI-BEYER
OF768R 1.8 mm

90° upwards cutting
nach oben schneidend

85 mm, 3 3/8"



OK711R 4.0 mm

OK712R 5.0 mm

KERRISON
OK711R-OK712R

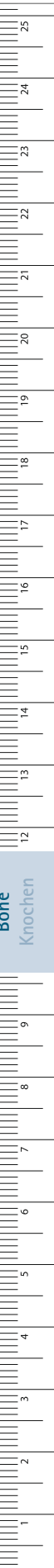

Bone
Knochen

Bone Instruments – Knocheninstrumente

Bone Punches

Knochenstanzen



90° upwards cutting
nach oben schneidend

140 mm, 5 1/2"



OK740R 3.3 mm



OK742R 4.0 mm

HAJEK-KOFLER

OK740R-OK742R



90° downwards cutting
nach unten schneidend

140 mm, 5 1/2"



HAJEK-KOFLER

OK741R 3.3 mm



Bone
Knochen

Bone Instruments – Knocheninstrumente

Bone Punches Knochenstanzen

90° upwards cutting
nach oben schneidend
rotates 360°
drehbar 360°

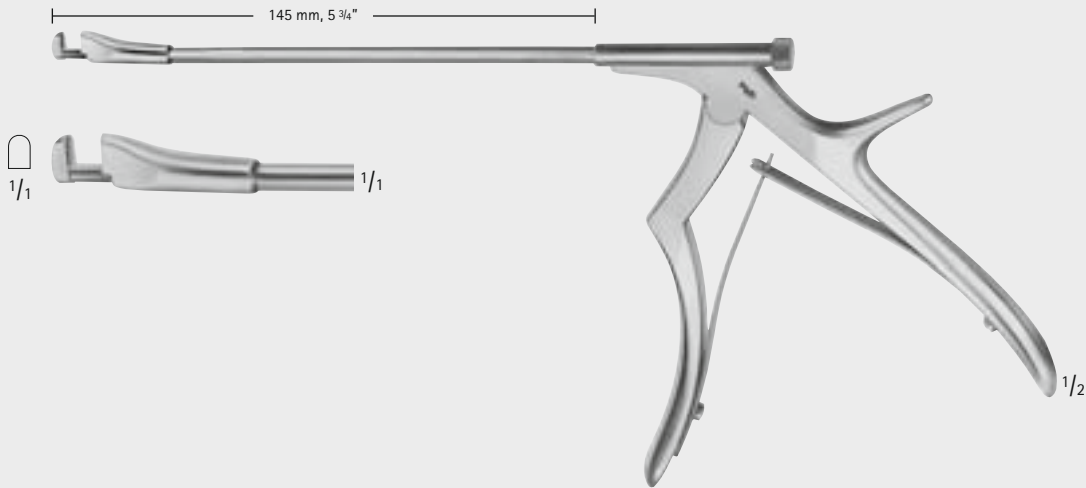

KOFLER

OK737R 3.0 mm

90° upwards cutting
nach oben schneidend
rotates 360°
drehbar 360°

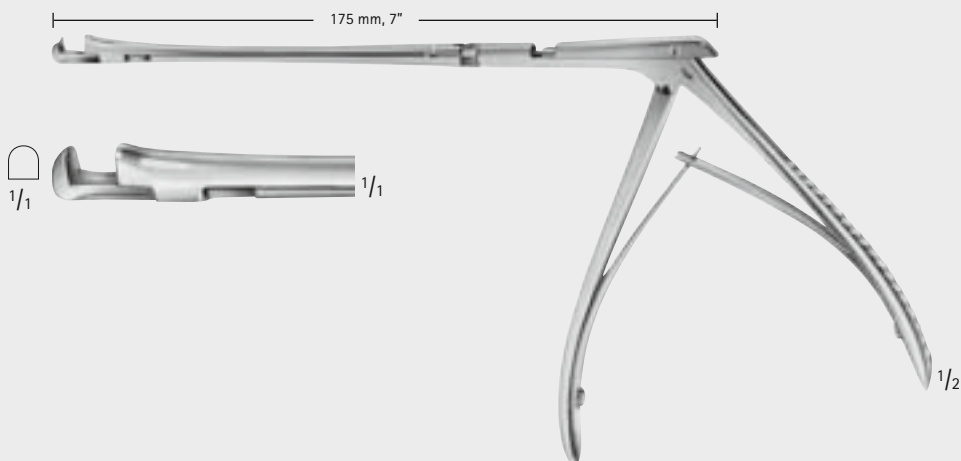

HAJEK-KOFLER

OK745R 4.0 mm

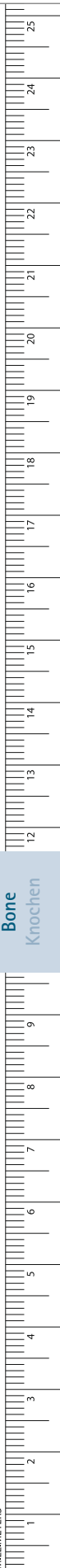

Bone Instruments – Knocheninstrumente

KERRISON Bone Punches

KERRISON Knochenstanzen

KERRISON Bone Punches



■ Non detachable design

- The classical KERRISON with excellent cutting quality and durability
- Nicht zerlegbare Ausführung
 - Die klassische KERRISON langlebig und mit exzellenter Schittqualität

■ Detachable design

- Can be taken apart easily without any tools for efficient cleaning
- Jaw ejector ensures easy removal of punched-out material
- Zerlegbare Ausführung
 - Für einen effiziente Reinigung einfach und ohne Werkzeuge zerlegbar
 - Auswerfer zur einfachen Entfernung von ausgestanztem Material

■ Noir® detachable design

- Same as detachable design, but with black Noir® coating
- Reduces irritating light reflection
- Increases surface hardness for improved cutting characteristics and service life
- Noir® zerlegbare Ausführung
 - Wie zerlegbare Ausführung aber mit schwarzer Noir® Beschichtung
 - Reduziert irritierende Lichtreflexionen
 - Erhöhte Oberflächeneigenschaft für bessere Schneideigenschaften und eine längere Lebensdauer

Complete product range:

- 90°/130° upwards/downwards cutting
- With regular/thin foot plate
- Standard/wide jaw opening
- Length:
 - 180 mm (7")
 - 200 mm (7 7/8")
 - 230 mm (9")
 - 280 mm (11")
- Width of jaw: 1-6 mm
- Half-sizes: 1.5 mm, 2.5 mm width

Komplettes Produktprogramm:

- 90°/130° nach oben/unten schneidend
- Mit Standard-Fußplatte/Dünnefußplatte
- Standard/Langhubstanzen
- Längen:
 - 180 mm (7")
 - 200 mm (7 7/8")
 - 230 mm (9")
 - 280 mm (11")
- Maulbreiten: 1-6 mm
- Zwischengrößen: 1,5 mm, 2,5 mm Maulbreite

Bone Instruments – Knocheninstrumente

KERRISON Bone Punches

KERRISON Knochenstanzen

Features Eigenschaften

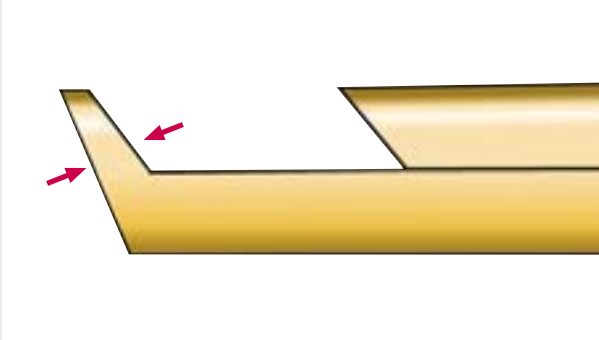

Kerrison punches with a **thin footplate** are marked with a golden distal end.

Die Kerrison Stanzen mit **Dünnpfußplatte** sind durch ein goldenes, distales Ende gekennzeichnet.

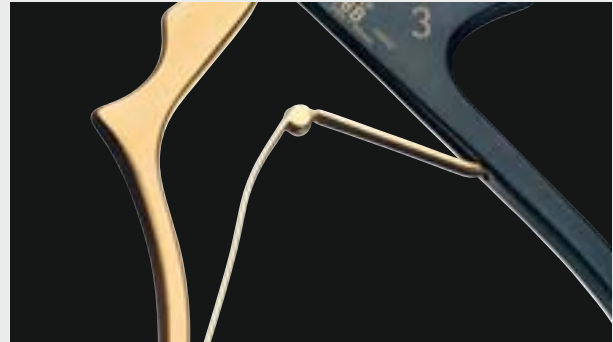

Kerrison Noir® punches with a **thin footplate** are marked with a golden inner handle.

Kerrison Noir® Stanzen mit **Dünnpfußplatte** sind durch ein goldenes, inneres Griffteil gekennzeichnet.

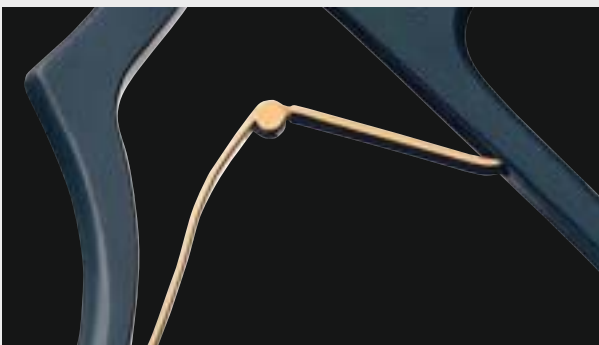

The golden spring stands for easy identification of detachable bone punches.

Die goldene Feder steht für einfache Erkennung von allen zerlegbaren Knochenstanzen.



Ejector – for the easy removal of punched-out material.

Auswerfer – zum einfachen Entfernen von ausgestanztem Material.

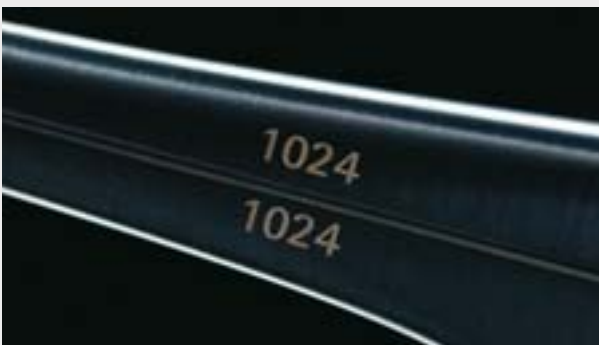

The **numerical code** ensures a safe and easy assignment and assembly of the two bone punch components which belong together.

Nummernkodierung – für die sichere Zuordnung beim Zusammensetzen der beiden zusammengehörenden Stanzenanteile.



Large number for identification of jaw width at a glance.

Große Ziffer zur leichten Erkennung der Maulbreite auf einen Blick.

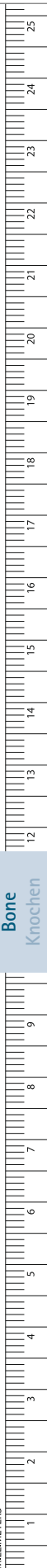

Bone
Knochen

MILLIMETERS

Bone Instruments – Knocheninstrumente

Noir® – Coated KERRISON Punches

Noir® KERRISON Knochenstanzen

Jaw position 130°, upwards
Maulstellung 130°, oben



Shaft length Schaftlänge (mm)	Width Breite (mm)	Footplate Fußplatte	Art. No. Art. Nr.	Ejector Auswerfer	Jaw opening Hub (mm)
180	1.0	standard	FK900B	-	8
	1.0	thin	FK906B	-	8
	1.5	standard	FK911B	-	9
	1.5	thin	FK923B	-	9
	1.5	standard	FK941B	-	15
	2.0	standard	FK901B	✓	9
	2.0	thin	FK907B	✓	9
	2.0	standard	FK971B	✓	15
	2.5	standard	FK912B	✓	10
	2.5	thin	FK924B	✓	10
	2.5	standard	FK942B	✓	15
	3.0	standard	FK902B	✓	10
	3.0	thin	FK908B	✓	10
	3.0	standard	FK972B	✓	15
	4.0	standard	FK903B	✓	12
	4.0	thin	FK909B	✓	12
	4.0	standard	FK973B	✓	15
	5.0	standard	FK904B	✓	12
	5.0	thin	FK910B	✓	12
	5.0	standard	FK974B	✓	15
6.0	standard	FK905B	✓	12	
6.0	standard	FK975B	✓	15	
200	1.0	thin	FK961B	-	8
	1.5	standard	FK966B	-	9
	1.5	thin	FK968B	-	9
	2.0	standard	FK913B	✓	9
	2.0	thin	FK962B	✓	9
	2.0	standard	FK970B	✓	15
	2.5	standard	FK967B	✓	10
	2.5	thin	FK969B	✓	10
	3.0	standard	FK914B	✓	10
	3.0	thin	FK963B	✓	10
	3.0	standard	FK982B	✓	15
	4.0	standard	FK915B	✓	12
	4.0	thin	FK964B	✓	12
	4.0	standard	FK983B	✓	15
	5.0	standard	FK916B	✓	12
	5.0	thin	FK965B	✓	12
	5.0	standard	FK984B	✓	15
	6.0	standard	FK917B	✓	12
	6.0	standard	FK985B	✓	15
	230	2.0	thin	FK925B	✓
3.0		thin	FK926B	✓	10
4.0		thin	FK927B	✓	12
5.0		thin	FK928B	✓	12
280	2.0	thin	FK976B	✓	9
	3.0	thin	FK977B	✓	10
	4.0	thin	FK978B	✓	12
	5.0	thin	FK979B	✓	12



Bone
Knochen

Bone Instruments - Knocheninstrumente

Noir® - Coated KERRISON Punches

Noir® KERRISON Knochenstanzen



Jaw position 90°, upwards
Maulstellung 90°, oben

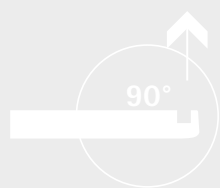

Shaft length Schaftlänge (mm)	Width Breite (mm)	Footplate Fußplatte	Art. No. Art. Nr.	Ejector Auswerfer	Jaw opening Hub (mm)
180	1.0	standard	FK948B	-	8
	2.0	standard	FK949B	✓	9
	3.0	standard	FK950B	✓	10
	4.0	standard	FK951B	✓	12
	5.0	standard	FK952B	✓	12
	6.0	standard	FK953B	✓	12

Width (mm)
Breite (mm)

1.0

1.5

2.0

2.5

3.0

4.0

5.0

6.0

Bone
Knochen

MILLIMETERS

Bone Instruments – Knocheninstrumente

Detachable KERRISON Bone Punches

Zerlegbare KERRISON Knochenstanzen

Jaw position 130°, upwards
Maulstellung 130°, oben



Shaft length Schaftlänge (mm)	Width Breite (mm)	Footplate Fußplatte	Art. No. Art. Nr.	Ejector Auswerfer	Jaw opening Hub (mm)
180	1.0	standard	FK900R	-	8
	1.0	thin	FK906R	-	8
	1.5	standard	FK911R	-	9
	1.5	thin	FK923R	-	9
	1.5	standard	FK941R	-	15
	2.0	standard	FK901R	✓	9
	2.0	thin	FK907R	✓	9
	2.0	standard	FK971R	✓	15
	2.5	standard	FK912R	✓	10
	2.5	thin	FK924R	✓	10
	2.5	standard	FK942R	✓	15
	3.0	standard	FK902R	✓	10
	3.0	thin	FK908R	✓	10
	3.0	standard	FK972R	✓	15
	4.0	standard	FK903R	✓	12
	4.0	thin	FK909R	✓	12
	4.0	standard	FK973R	✓	15
	5.0	standard	FK904R	✓	12
	5.0	thin	FK910R	✓	12
	5.0	standard	FK974R	✓	15
6.0	standard	FK905R	✓	12	
6.0	standard	FK975R	✓	15	
200	1.0	thin	FK961R	-	8
	1.5	standard	FK966R	-	9
	1.5	thin	FK968R	-	9
	2.0	standard	FK913R	✓	9
	2.0	thin	FK962R	✓	9
	2.0	standard	FK970R	✓	15
	2.5	standard	FK967R	✓	10
	2.5	thin	FK969R	✓	10
	3.0	standard	FK914R	✓	10
	3.0	thin	FK963R	✓	10
	3.0	standard	FK982R	✓	15
	4.0	standard	FK915R	✓	12
	4.0	thin	FK964R	✓	12
	4.0	standard	FK983R	✓	15
	5.0	standard	FK916R	✓	12
	5.0	thin	FK965R	✓	12
	5.0	standard	FK984R	✓	15
	6.0	standard	FK917R	✓	12
	6.0	standard	FK985R	✓	15
	230	2.0	standard	FK919R	✓
2.0		thin	FK925R	✓	9
3.0		standard	FK920R	✓	10
3.0		thin	FK926R	✓	10
4.0		standard	FK921R	✓	12
4.0		thin	FK927R	✓	12
5.0		standard	FK922R	✓	12
5.0		thin	FK928R	✓	12
280	2.0	thin	FK976R	✓	9
	3.0	thin	FK977R	✓	10
	4.0	thin	FK978R	✓	12
	5.0	thin	FK979R	✓	12

Bone Instruments – Knocheninstrumente

Detachable KERRISON Bone Punches

Zerlegbare KERRISON Knochenstanzen



Jaw position 130°, downwards
Maulstellung 130°, unten



Shaft length Schaftlänge (mm)	Width Breite (mm)	Footplate Fußplatte	Art. No. Art. Nr.	Ejector Auswerfer	Jaw opening Hub (mm)
180	1.0	standard	FK930R	-	8
	1.0	thin	FK936R	-	8
	2.0	standard	FK931R	✓	9
	2.0	thin	FK937R	✓	9
	3.0	standard	FK932R	✓	10
	3.0	thin	FK938R	✓	10
	4.0	standard	FK933R	✓	12
	4.0	thin	FK939R	✓	12
	5.0	standard	FK934R	✓	12
	5.0	thin	FK940R	✓	12
230	2.0	standard	FK943R	✓	9
	3.0	standard	FK944R	✓	10
	4.0	standard	FK945R	✓	12
	5.0	standard	FK946R	✓	12

Jaw position 90°, upwards
Maulstellung 90°, oben

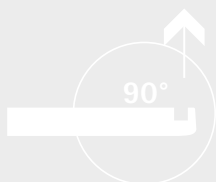

Shaft length Schaftlänge (mm)	Width Breite (mm)	Footplate Fußplatte	Art. No. Art. Nr.	Ejector Auswerfer	Jaw opening Hub (mm)
180	1.0	standard	FK948R	-	8
	2.0	standard	FK949R	✓	9
	3.0	standard	FK950R	✓	10
	4.0	standard	FK951R	✓	12
	5.0	standard	FK952R	✓	12
	6.0	standard	FK953R	✓	12

Jaw position 90°, downwards
Maulstellung 90°, unten

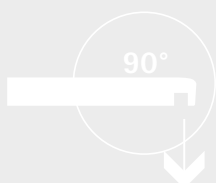

Shaft length Schaftlänge (mm)	Width Breite (mm)	Footplate Fußplatte	Art. No. Art. Nr.	Ejector Auswerfer	Jaw opening Hub (mm)
180	1.0	standard	FK945R	-	8
	2.0	standard	FK955R	✓	9
	3.0	standard	FK956R	✓	10
	4.0	standard	FK957R	✓	12
	5.0	standard	FK958R	✓	12
	6.0	standard	FK959R	✓	12

Width (mm)
Breite (mm)

1.0 □

1.5 □

2.0 □

2.5 □

3.0 □

4.0 □

5.0 □

6.0 □

Bone Instruments – Knocheninstrumente

Detachable KERRISON Bone Punches

Zerlegbare KERRISON Knochenstanzen

Jaw position 130°, upwards
Maulstellung 130°, oben



Shaft length Schaftlänge (mm)	Width Breite (mm)	Footplate Fußplatte	Art. No. Art. Nr.	Jaw opening Hub (mm)	
180	1.0	standard	FF715R	8	
	1.0	thin	FF771R	8	
	1.5	standard	FF638R	9	
	1.5	thin	FF645R	9	
	1.5	standard	FF647R	15	
	2.0	standard	FF717R	9	
	2.0	thin	FF772R	9	
	2.0	standard	FF677R	15	
	2.5	standard	FF639R	10	
	2.5	thin	FF646R	10	
	2.5	standard	FF648R	15	
	3.0	standard	FF720R	10	
	3.0	thin	FF773R	10	
	3.0	standard	FF678R	15	
	4.0	standard	FF724R	12	
	4.0	thin	FF769R	12	
	4.0	standard	FF679R	15	
	5.0	standard	FF722R	12	
	5.0	thin	FF770R	12	
	5.0	standard	FF680R	15	
6.0	standard	FF726R	12		
6.0	standard	FF681R	15		
200	1.0	thin	FF661R	8	
	1.5	standard	FF649R	9	
	1.5	thin	FF658R	9	
	2.0	standard	FF737R	9	
	2.0	thin	FF662R	9	
	2.0	standard	FF660R	15	
	2.5	standard	FF657R	10	
	2.5	thin	FF659R	10	
	3.0	standard	FF738R	10	
	3.0	thin	FF663R	10	
	3.0	standard	FF739R	15	
	4.0	standard	FF727R	12	
	4.0	thin	FF664R	12	
	4.0	standard	FF745R	15	
	5.0	standard	FF728R	12	
	5.0	thin	FF665R	12	
	5.0	standard	FF751R	15	
	6.0	standard	FF729R	12	
	6.0	standard	FF753R	15	
	230	2.0	standard	FF682R	9
2.0		thin	FF746R	9	
3.0		standard	FF683R	10	
3.0		thin	FF747R	10	
4.0		standard	FF684R	12	
4.0		thin	FF748R	12	
5.0		standard	FF685R	12	
5.0		thin	FF749R	12	
280		2.0	thin	FF666R	9
		3.0	thin	FF667R	10
	4.0	thin	FF668R	12	
	5.0	thin	FF669R	12	



Bone
Knochen

Bone Instruments – Knocheninstrumente

Non Detachable KERRISON Bone Punches

Nicht Zerlegbare KERRISON Knochenstanzen

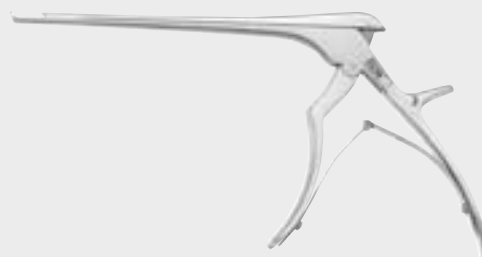

Jaw position 130°, downwards
Maulstellung 130°, unten



Shaft length Schaftlänge (mm)	Width Breite (mm)	Footplate Fußplatte	Art. No. Art. Nr.	Jaw opening Hub (mm)
180	1.0	standard	FF711R	8
	1.0	thin	FF781R	8
	2.0	standard	FF712R	9
	2.0	thin	FF782R	9
	3.0	standard	FF713R	10
	3.0	thin	FF783R	10
	4.0	standard	FF714R	12
	4.0	thin	FF784R	12
	5.0	standard	FF725R	12
	5.0	thin	FF785R	12
230	2.0	standard	FF692R	9
	3.0	standard	FF693R	10
	4.0	standard	FF694R	12
	5.0	standard	FF695R	12

Jaw position 90°, upwards
Maulstellung 90°, oben

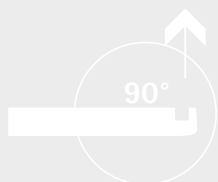

Shaft length Schaftlänge (mm)	Width Breite (mm)	Footplate Fußplatte	Art. No. Art. Nr.	Jaw opening Hub (mm)
180	1.0	standard	FF716R	8
	2.0	standard	FF718R	9
	3.0	standard	FF750R	10
	4.0	standard	FF752R	12
	5.0	standard	FF754R	12
	6.0	standard	FF755R	12

Jaw position 90°, downwards
Maulstellung 90°, unten

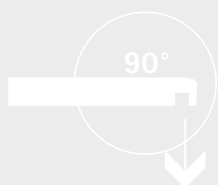

Shaft length Schaftlänge (mm)	Width Breite (mm)	Footplate Fußplatte	Art. No. Art. Nr.	Jaw opening Hub (mm)
180	1.0	standard	FF741R	8
	2.0	standard	FF719R	9
	3.0	standard	FF721R	10
	4.0	standard	FF742R	12
	5.0	standard	FF723R	12
	6.0	standard	FF743R	12

Width (mm)
Breite (mm)

1.0 □

1.5 □

2.0 □

2.5 □

3.0 □

4.0 □

5.0 □

6.0 □

Bone Instruments – Knocheninstrumente

DUROGRIP® Wire Holding Forceps, Wire Twisters

DUROGRIP® Drahtfasszangen, Drahtspannzangen



LX176R
 Holding forceps for cerclage wire,
 with lateral jaws to avoid wire slipping off
 Drahtfasszange
 mit seitlichen Backen gegen Abrutschen des Drahtes
 170 mm, 6 3/4"

BM110R
 Wire twister,
 ligature forceps
 Drahtspannzange,
 Ligaturzange
 150 mm, 6"

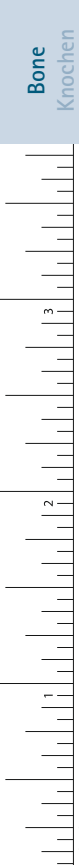

Bone
Knochen

BM111R
 Wire twister,
 ligature forceps
 Drahtspannzange,
 Ligaturzange
 150 mm, 6"

**BAUMGARTNER
 BM112R**
 Wire twister,
 ligature forceps
 Drahtspannzange,
 Ligaturzange
 200 mm, 7 7/8"

Bone Instruments – Knocheninstrumente

Wire Bending Pliers, Round Nose Pliers, Flat Pliers

Drahtbiegezangen, Rundzangen, Flachzangen



DP011R

Wire bending pliers
Drahtbiegezange
140 mm, 5 1/2"



DP121R

Round nose pliers, fine pattern
Rundzange, feines Modell
140 mm, 5 1/2"



LANGENBECK

DP122R

Round nose pliers
Rundzange
140 mm, 5 1/2"

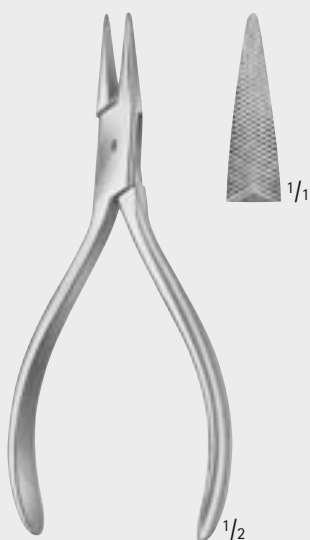

MARBURG MODELL

DP031R

Wire bending pliers, with serrated jaws
Flachzange, beidseitig kariert
140 mm, 5 1/2"



GOSLEE

DP035R

Wire bending pliers, one jaw smooth,
one jaw serrated
Flachzange, eine Seite glatt,
eine Seite kariert
140 mm, 5 1/2"

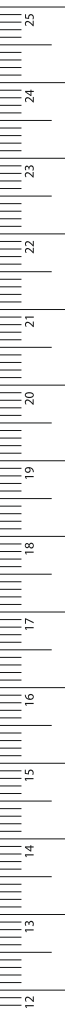

Bone
Knochen

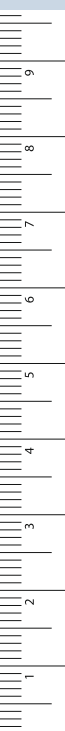

Bone Instruments – Knocheninstrumente

Wire Cutting Scissors

Blech- und Drahtscheren

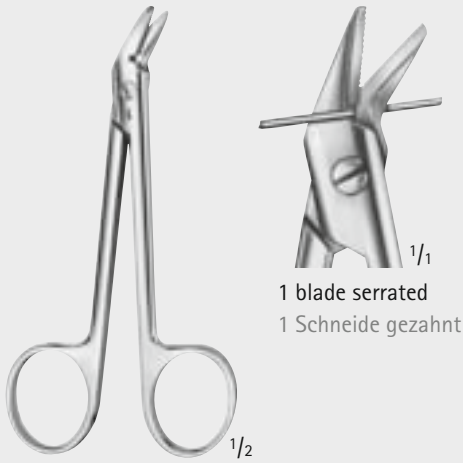

1 blade serrated
1 Schneide gezahnt

DP551R

Wire scissors, 1 blade serrated for soft wire up to diam. 1.2 mm, for hard wire up to diam. 0.6 mm
Drahtschere, 1 Schneide gezahnt für weichen Draht bis Ø 1,2 mm, für harten Draht bis Ø 0,6 mm
120 mm, 4 3/4"

- DUROTIP®
 - Jaws with tungsten carbide inserts
- DUROTIP®
 - Maulteile mit Hartmetalleinlage

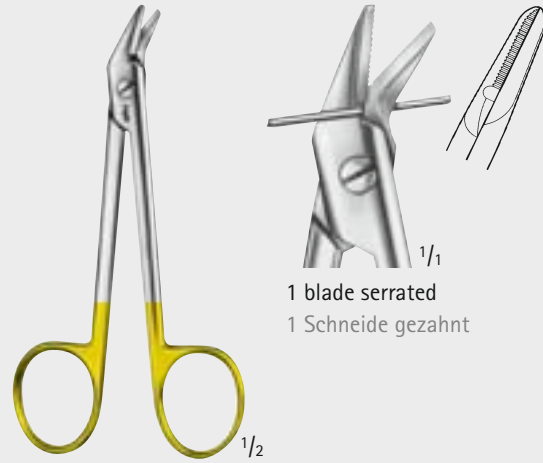

1 blade serrated
1 Schneide gezahnt

DP552R

Wire scissors, 1 blade serrated for soft wire up to diam. 1.2 mm, for hard wire up to diam. 0.8 mm
Drahtschere, 1 Schneide gezahnt für weichen Draht bis Ø 1,2 mm, für harten Draht bis Ø 0,8 mm
120 mm, 4 3/4"

Bone
Knochen



HARVEY

BC815R

Wire cutting scissors, 1 blade serrated for soft wire up to diam. 0.4 mm, for hard wire up to diam. 0.3 mm
Blech- und Drahtschere, 1 Schneide gezahnt für weichen Draht bis Ø 0,4 mm, für harten Draht bis Ø 0,3 mm
125 mm, 5"

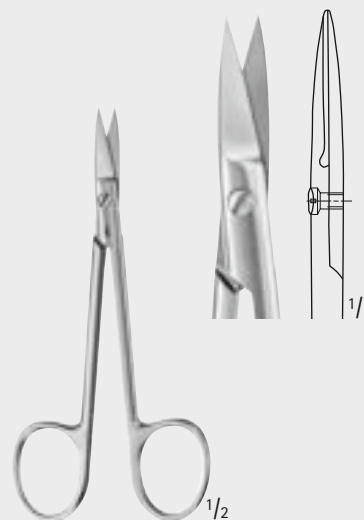

GUILFORD-WRIGHT

BC814R

Wire scissors, blades serrated
Drahtscherchen, Schneiden gezahnt
110 mm, 4 1/4"

Bone Instruments - Knocheninstrumente

Wire Cutting Scissors

Blech- und Drahtscheren



BEEBE

DP560R-DP569R

110 mm, 4 1/4"

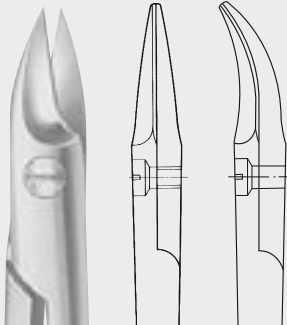

DP560R

DP561R

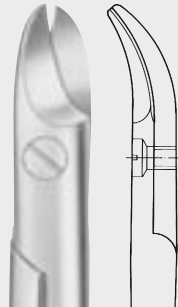

DP563R

broad blades
breite Blätter

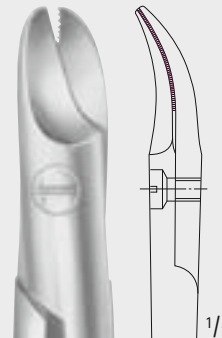

DP569R

1 blade serrated
1 Schneide gezahnt

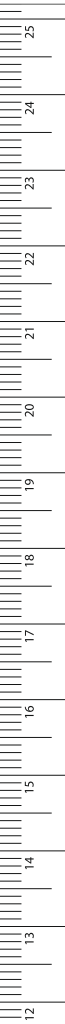

Bone
Knochen

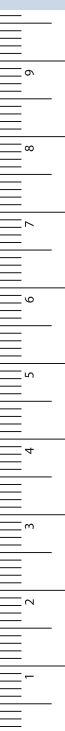

Bone Instruments – Knocheninstrumente

Wire Cutters

Drahtschneidezangen



ANGLE
DP540R
Wire cutter
for soft wire up to diam. 0.5 mm,
for hard wire up to diam. 0.3 mm
Drahtschneidezange
für weichen Draht bis Ø 0,5 mm,
für harten Draht bis Ø 0,3 mm
130 mm, 5 1/8"

- specially hardened cutting edges
- speziell vergütete Schneiden

ANGLE
DP541R
Wire cutter
for soft wire up to diam. 0.6 mm,
for hard wire up to diam. 0.4 mm
Drahtschneidezange
für weichen Draht bis Ø 0,6 mm,
für harten Draht bis Ø 0,4 mm
130 mm, 5 1/8"

DP505R
Wire cutter
for soft wire up to diam. 1.5 mm,
for hard wire up to diam. 1.2 mm
Drahtschneidezange
für weichen Draht bis Ø 1,5 mm,
für harten Draht bis Ø 1,2 mm
160 mm, 6 1/4"

DP501R
Wire cutter
for soft wire up to diam. 1.5 mm,
for hard wire up to diam. 1.0 mm
Drahtschneidezange
für weichen Draht bis Ø 1,5 mm,
für harten Draht bis Ø 1,0 mm
150 mm, 6"

- specially hardened cutting edges
- speziell vergütete Schneiden

DP530R
Wire cutter
for soft wire up to diam. 1.5 mm,
for hard wire up to diam. 1.0 mm
Drahtschneidezange
für weichen Draht bis Ø 1,5 mm,
für harten Draht bis Ø 1,0 mm
140 mm, 5 1/2"

Bone Instruments – Knocheninstrumente

Wire Cutters

Drahtschneidezangen

- specially hardened cutting edges
- speziell vergütete Schneiden



DP520R

Wire cutter
for soft wire up to diam. 1.5 mm,
for hard wire up to diam. 1.0 mm
Drahtschneidezange
für weichen Draht bis Ø 1,5 mm,
für harten Draht bis Ø 1,0 mm
145 mm, 5 3/4"

- specially hardened cutting edges
- speziell vergütete Schneiden



LX150R

Wire cutter
for soft wire up to diam. 2.0 mm,
for hard wire up to diam. 1.5 mm
Drahtschneidezange
für weichen Draht bis Ø 2,0 mm,
für harten Draht bis Ø 1,5 mm
145 mm, 5 3/4"

- specially hardened cutting edges
- speziell vergütete Schneiden



LX158R

Wire cutters, front- and lateral
cutting action
for soft wire up to diam. 2.0 mm,
for hard wire up to diam. 1.5 mm
Kopf- und Seitenschneider
für weichen Draht bis Ø 2,0 mm,
für harten Draht bis Ø 1,5 mm
180 mm, 7"

- specially hardened cutting edges
- speziell vergütete Schneiden

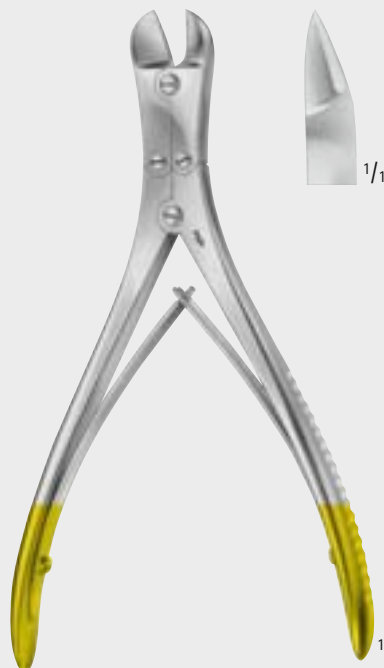

REILL

LX159R

Wire cutter
for soft wire up to diam. 2.0 mm,
for hard wire up to diam. 1.5 mm
Drahtschneidezange
für weichen Draht bis Ø 2,0 mm,
für harten Draht bis Ø 1,5 mm
175 mm, 6 7/8"

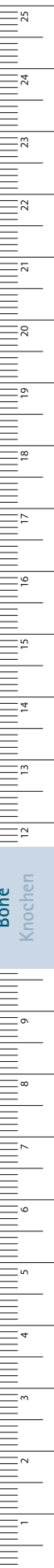

Bone Instruments – Knocheninstrumente



Bone
Knochen

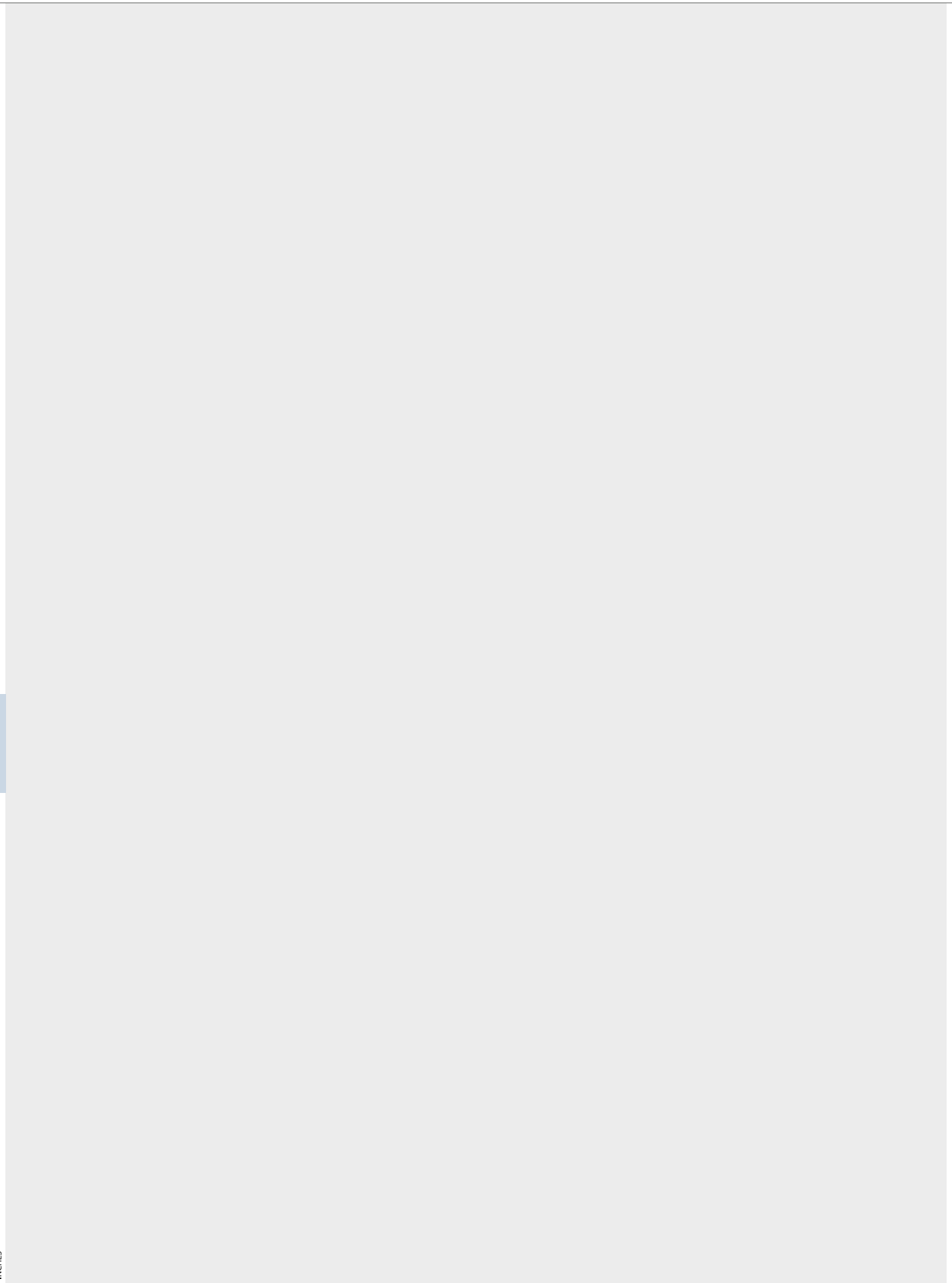

Retraktors, Hooks
Retraktoren, Wundhaken



Retractors, Hooks – Retraktoren, Wundhaken

Tracheal Dilators

Trachealdilatatoren



TROUSSEAU

FA005R

120 mm, 4 ³/₄"

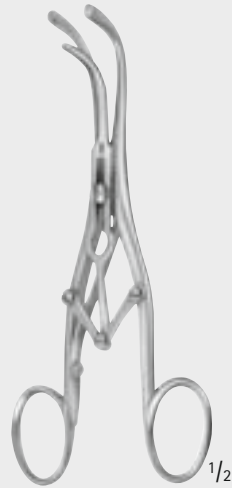

LABORDE

FA006R

125 mm, 5"



LABORDE

FA007R

strong pattern
kräftiges Modell
135 mm, 5 ¹/₄"

Retractors
Retraktoren

Retractors, Hooks – Retraktoren, Wundhaken

Self-Retaining Retractors

Wundspreizer

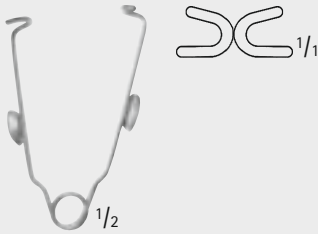

BOSE

FA001R

60 mm, 2 3/8"



FINSEN

BV001R

50 mm, 2"

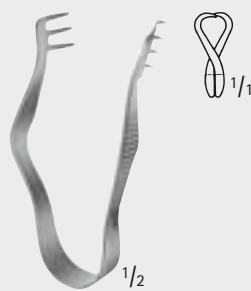

FINSEN

BV002R

70 mm, 2 3/4"

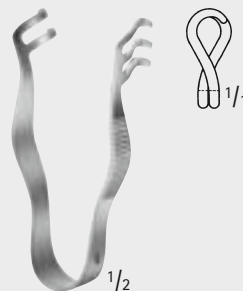

FINSEN MODIF.

BV003R

75 mm, 3"

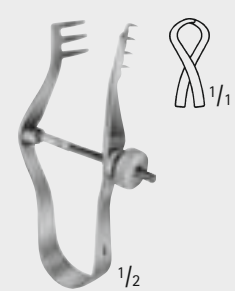

FINSEN

BV005R

70 mm, 2 3/4"

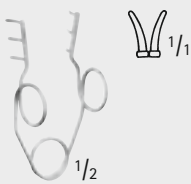

BV006R

45 mm, 1 3/4"

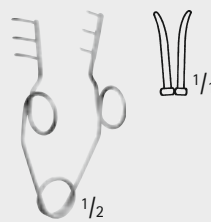

BV007R

55 mm, 2 1/4"

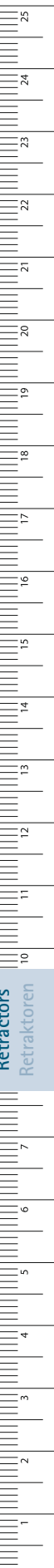

Retractors
Retraktoren

MILLIMETERS

Retractors, Hooks – Retraktoren, Wundhaken

Self-Retaining Retractors

Wundspreizer



ALLPORT

BV028R

95 mm, 3 3/4"



JANSEN

BV030R

100 mm, 4"

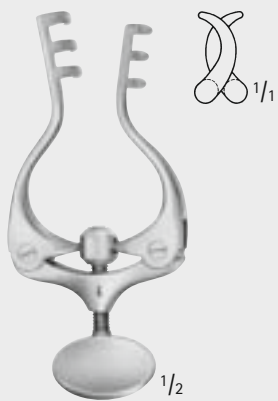

JANSEN

BV032R

100 mm, 4"

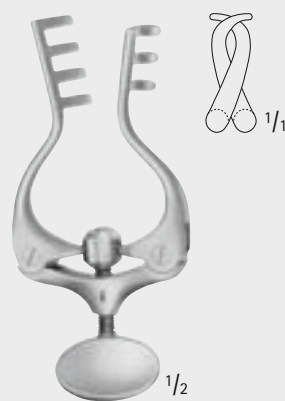

JANSEN

BV033R

100 mm, 4"

Retractors
Retraktoren

Retractors, Hooks – Retraktoren, Wundhaken

Self-Retaining Retractors

Wundspreizer

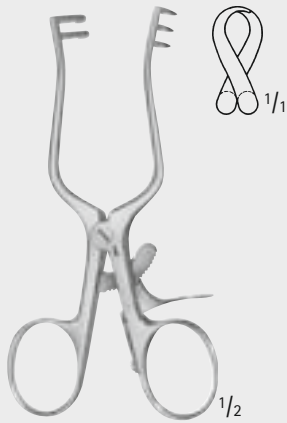

WEITLANER

BV070R

sharp

scharf

110 mm, 4 1/4"

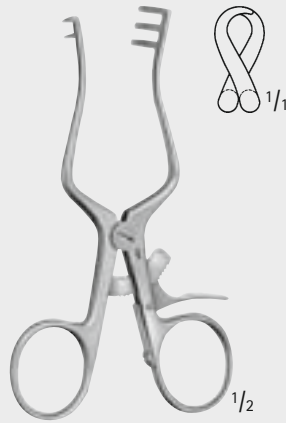

WEITLANER

BV066R

semi-sharp

halbscharf

110 mm, 4 1/4"

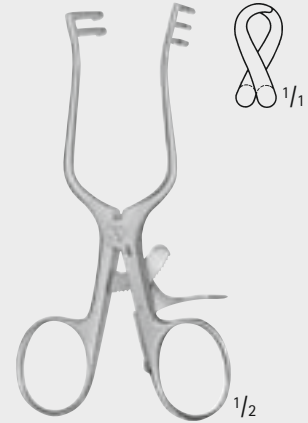

WEITLANER

BV073R

blunt

stumpf

110 mm, 4 1/4"

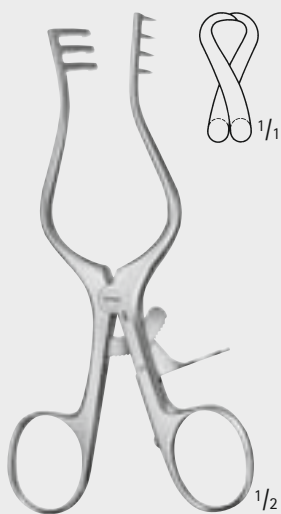

WEITLANER

BV071R

sharp

scharf

130 mm, 5 1/8"

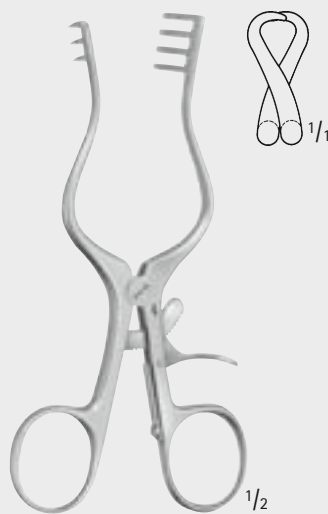

WEITLANER

BV067R

semi-sharp

halbscharf

130 mm, 5 1/8"

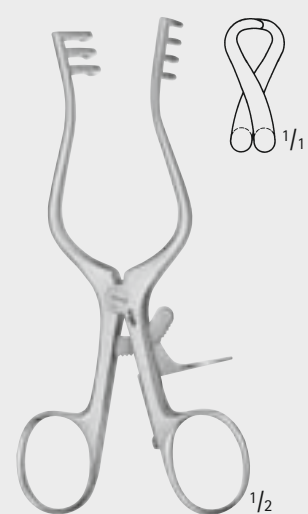

WEITLANER

BV074R

blunt

stumpf

130 mm, 5 1/8"

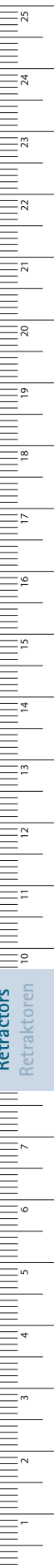

Retractors, Hooks – Retraktoren, Wundhaken

Self-Retaining Retractors

Wundspreizer

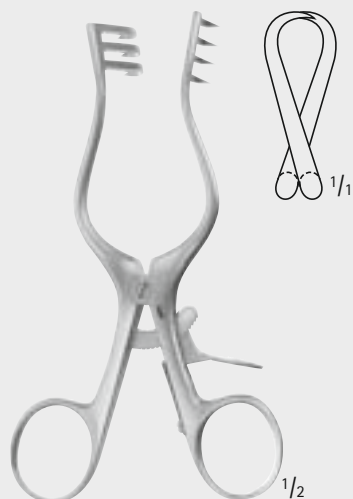

WEITLANER
BV101R
sharp
scharf
130 mm, 5 1/8"

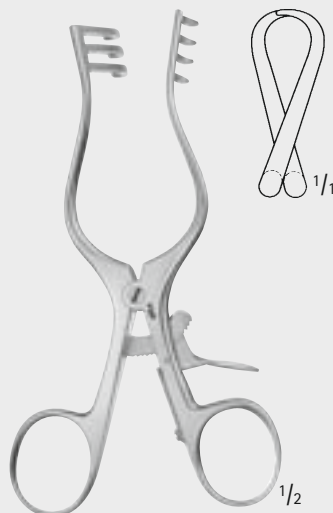

WEITLANER
BV104R
blunt
stumpf
130 mm, 5 1/8"

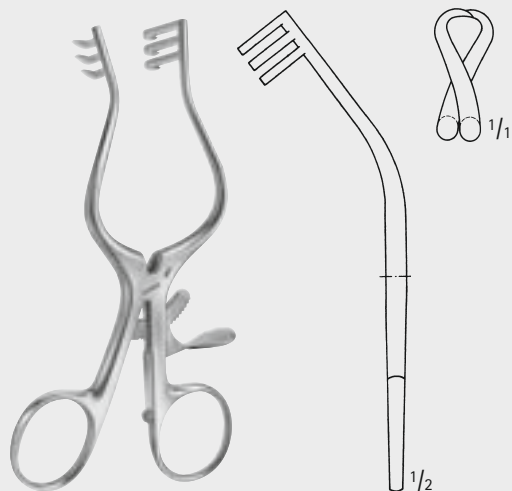

WULLSTEIN
BV076R
sharp
scharf
125 mm, 5"

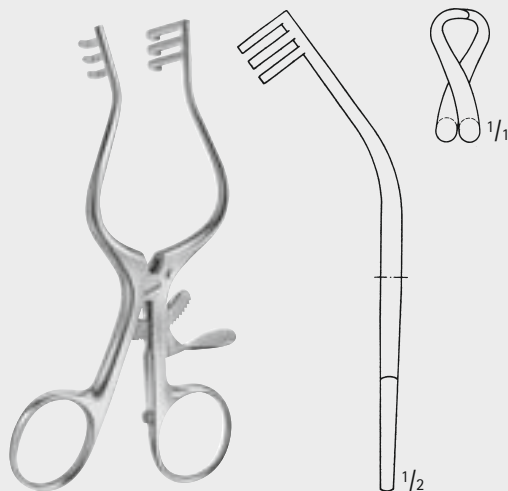

WULLSTEIN
BV077R
blunt
stumpf
125 mm, 5"

Retractors
Retraktoren

Retractors, Hooks – Retraktoren, Wundhaken

Self-Retaining Retractors

Wundspreizer

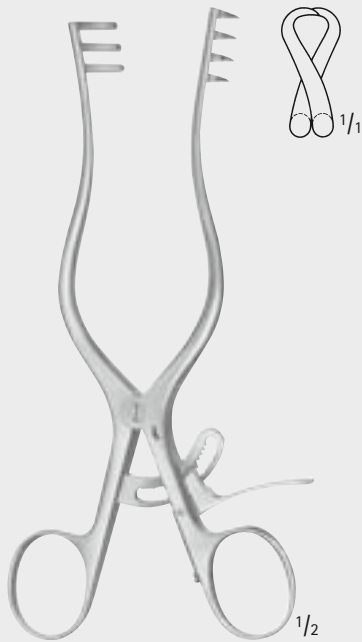

WEITLANER
BV072R
 sharp
 scharf
 165 mm, 6 1/2"

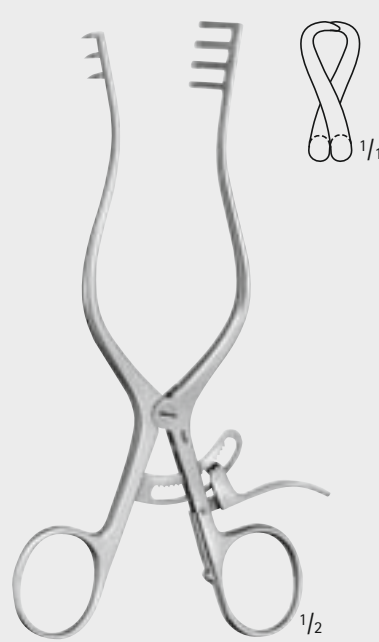

WEITLANER
BV068R
 semi-sharp
 halbscharf
 165 mm, 6 1/2"



WEITLANER
BV075R
 blunt
 stumpf
 165 mm, 6 1/2"



ALLENBERG
BV097R
 Carotis retractor complete,
 consisting of:
 BV098R Retractor only, blunt,
 170 mm, 6 3/4"
 BV099R Center blade only,
 120 mm, 4 3/4"
 Carotis-Sperrer komplett,
 bestehend aus:
 BV098R Sperrer allein, stumpf,
 170 mm, 6 3/4"
 BV099R Mittelblatt allein,
 120 mm, 4 3/4"

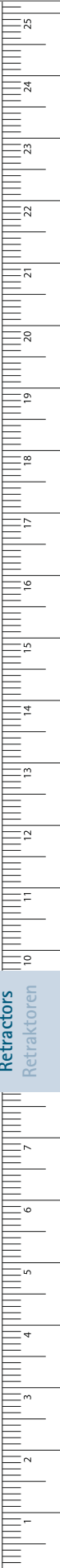

Retractors
 Retraktoren

Retractors, Hooks – Retraktoren, Wundhaken

Self-Retaining Retractors

Wundspreizer

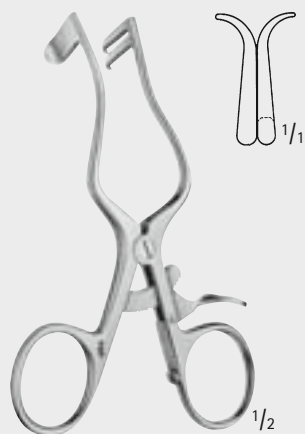
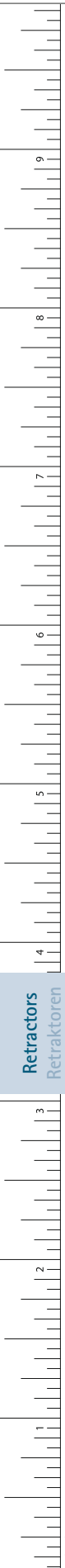

PLESTER
BV090R
 blunt
 stumpf
 110 mm, 4 1/4"



PLESTER
BV091R
 blunt
 stumpf
 110 mm, 4 1/4"

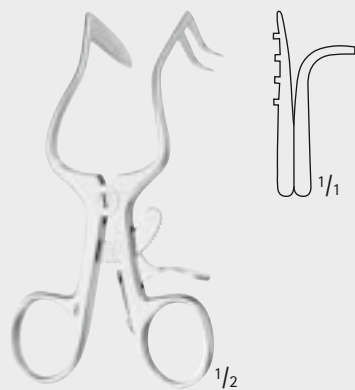

PLESTER-HELMS

Art. No. Art. Nr.	Tip Arbeitsende	Length Länge
BV105R	sharp, right retractor blade full scharf, rechtes Blatt voll	110 mm, 4 1/4"
BV106R	sharp, left retractor blade full scharf, linkes Blatt voll	110 mm, 4 1/4"

Retractors
Retraktoren

INCHES

Retractors, Hooks – Retraktoren, Wundhaken

Self-Retaining Retractors

Wundspreizer

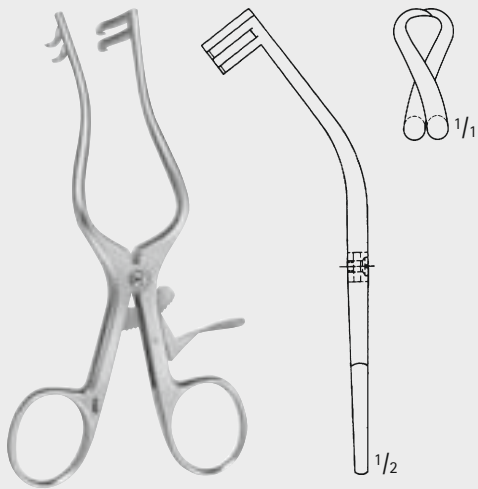

PLESTER

BV078R

sharp

scharf

130 mm, 5 1/8"

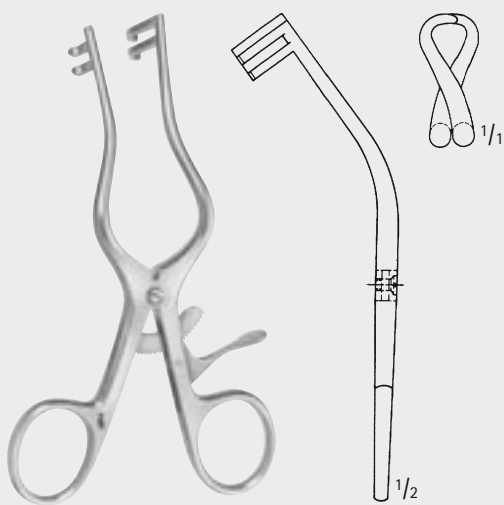

PLESTER

BV079R

blunt

stumpf

130 mm, 5 1/8"

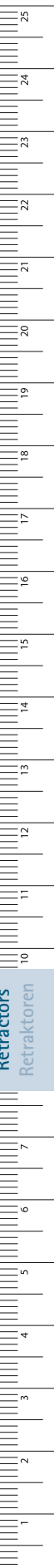

Retractors, Hooks – Retraktoren, Wundhaken

Self-Retaining Retractors

Wundspreizer

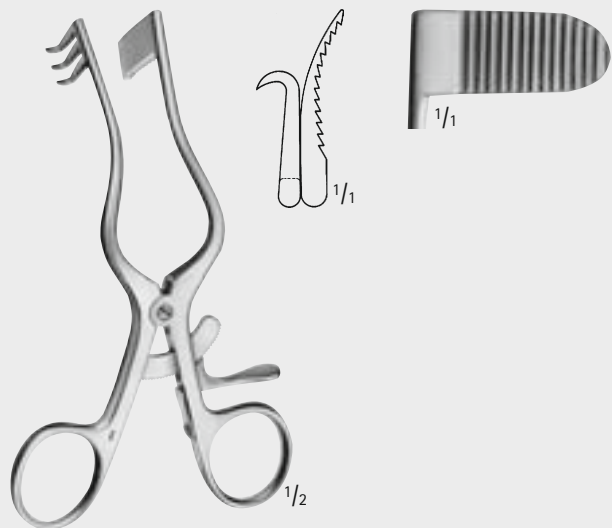

PERKINS

OK794R

130 mm, 5 1/8"

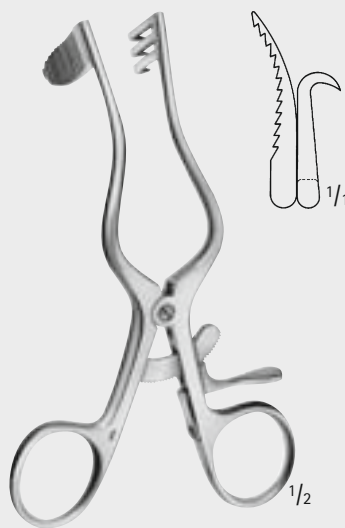

PERKINS

OK795R

130 mm, 5 1/8"



RNTNE HOSPITAL

BV084R

sharp

scharf

165 mm, 6 1/2"



ADSON-BABY

Art. No.	Tip	Length
Art. Nr.	Arbeitsende	Länge
BV085R	semi-sharp halbscharf	140 mm, 5 1/2"
BV094R	semi-sharp halbscharf	165 mm, 6 1/2"

Retractors, Hooks – Retraktoren, Wundhaken

Self-Retaining Retractor

Wundspreizer

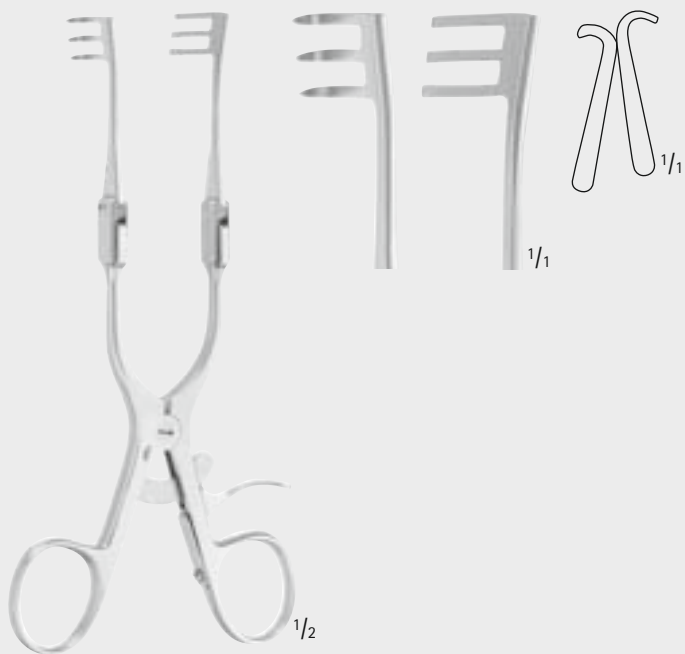

BV243R

semi-sharp

halbscharf

170 mm, 6 3/4"

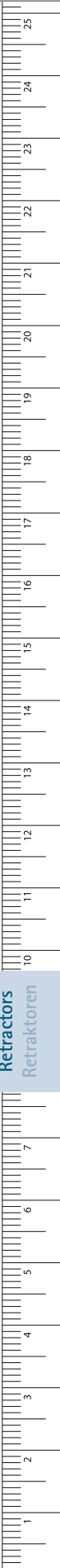

Retractors
Retraktoren

MILLIMETERS

Retractors, Hooks – Retraktoren, Wundhaken

Self-Retaining Retractors

Wundspreizer

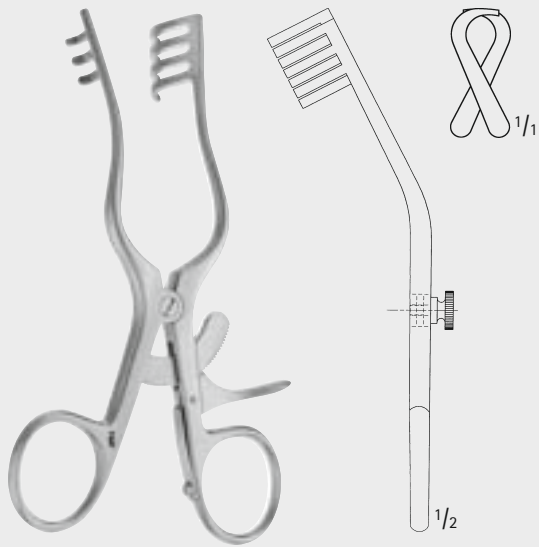

JEFFERSON

BV092R

curved, blunt
gebogen, stumpf
140 mm, 5 1/2"



MOLLISON

BV093R

sharp
scharf
140 mm, 5 1/2"

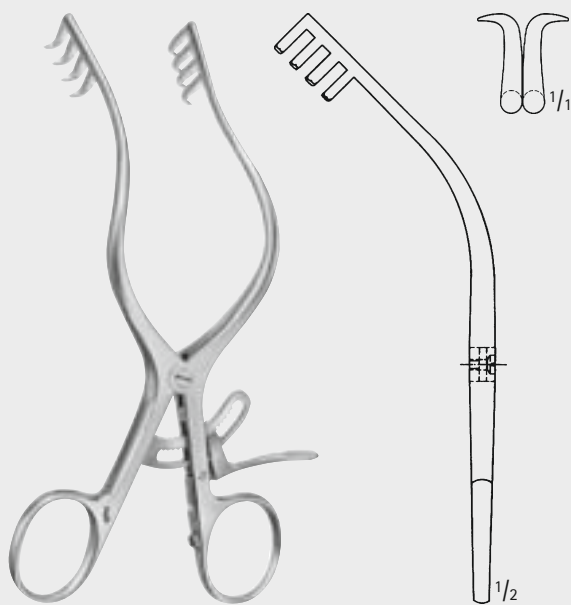

MOLLISON

BV088R

sharp
scharf
155 mm, 6 1/8"

Retractors
Retraktoren

INCHES

Retractors, Hooks – Retraktoren, Wundhaken

Self-Retaining Retractors

Wundspreizer



GELPI

BV996R

135 mm, 5 1/4"

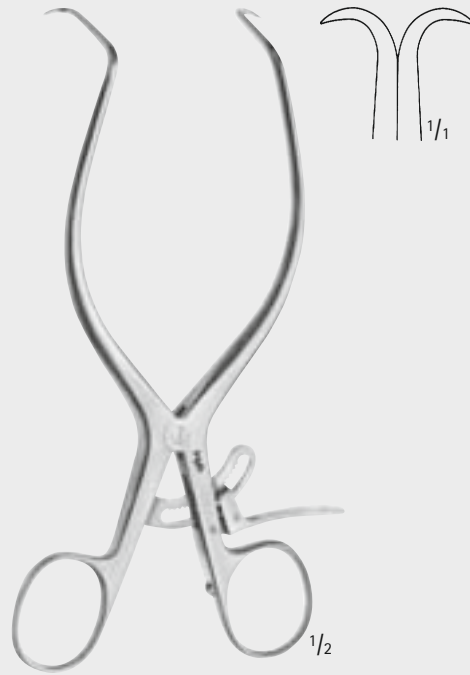

GELPI

BV997R

175 mm, 6 7/8"

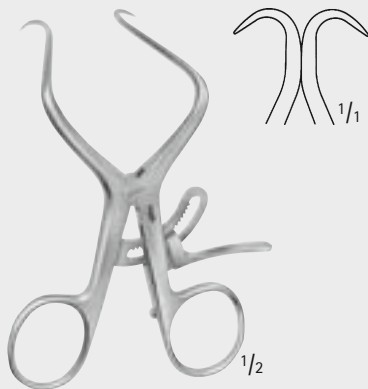

DE BAKEY

BV998R

100 mm, 4"

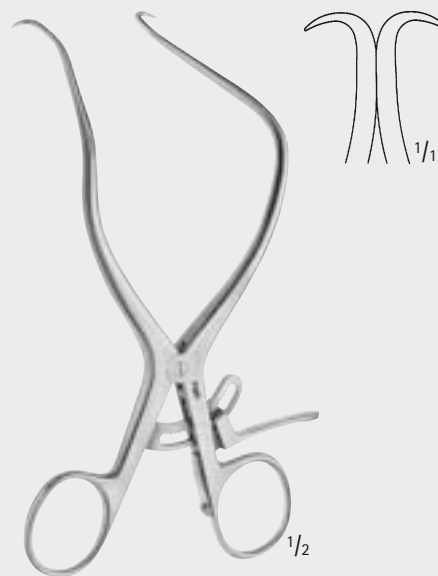

DE BAKEY

BV999R

145 mm, 5 1/2"

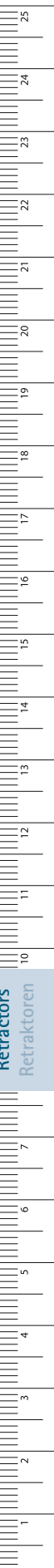

Retractors
Retraktoren

Retractors, Hooks – Retraktoren, Wundhaken

Glomus Spreader

Glomus Spreizer



Retractors
Retraktoren

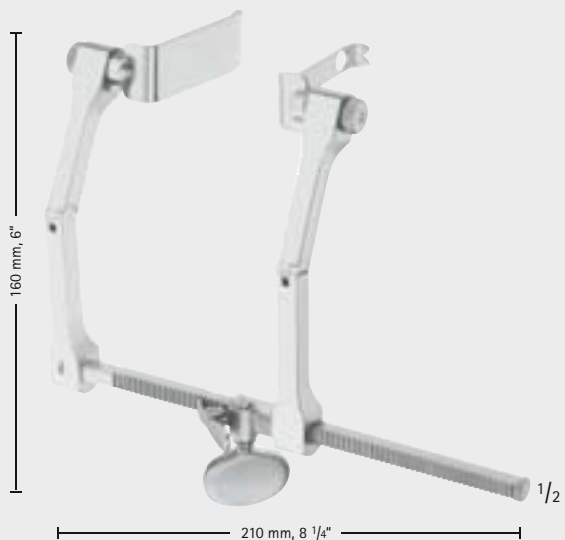

BV427R

Glomus-Spreader complete,
consisting of:
 BV428R Spreader, only
 BV432R short blade
 BV433R long and slim blade with hole
 BV434R long blade
 Glomus-Spreizer komplett,
 bestehend aus:
 BV428R Spreizer, allein
 BV432R kurzes Blatt
 BV433R langes, schmales Blatt mit Loch
 BV434R langes Blatt



BV432R

23.5 x 2 mm



BV433R

66 x 14 mm



BV434R

64 x 25 mm

Retractors, Hooks – Retraktoren, Wundhaken

Thyroid Retractors

Strumaspreizer

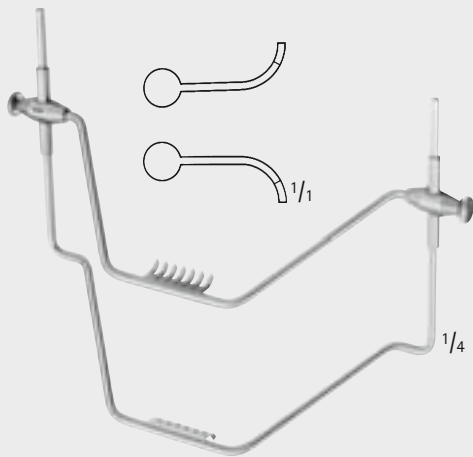

BV086R

Thyroid retractor
Strumaspreizer



JOLL (FRIEDMANN)

BV087R

Thyroid retractor
Strumaspreizer
155 mm, 6 1/8"

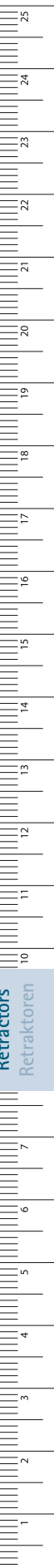

Retractors
Retraktoren

MILLIMETERS

Retractors, Hooks – Retraktoren, Wundhaken

Thyroid Frame

Strumarahmen

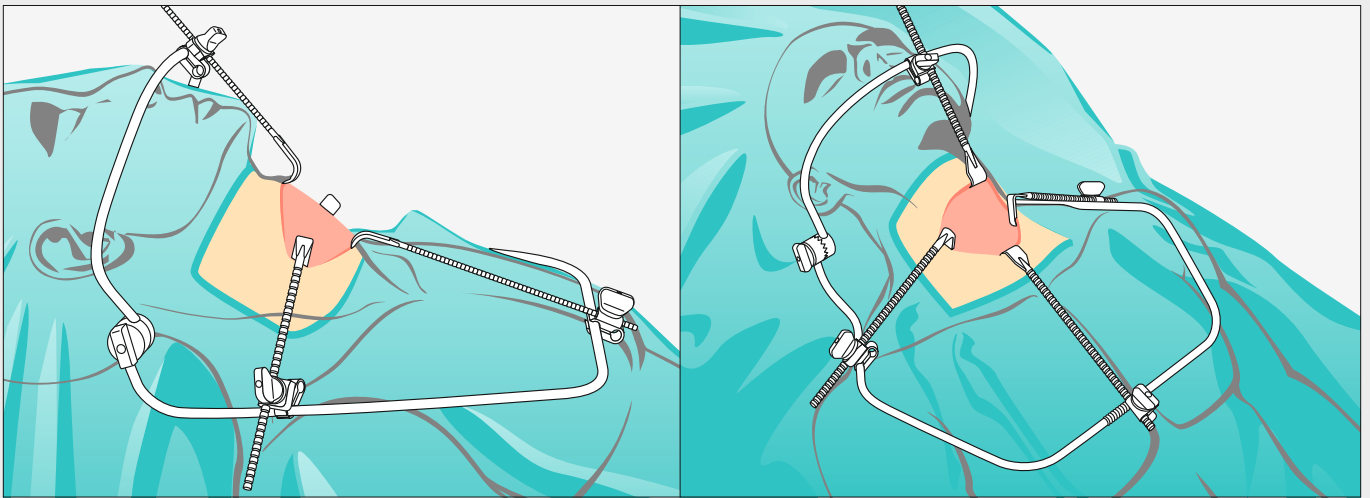

Retractors
Retraktoren

INCHES

Retractors, Hooks – Retraktoren, Wundhaken

Thyroid Frame Strumarahmen

- Parts of the system
- System-Bestandteile



BW081R

Fixation clamp
Befestigungsklemme



BW080R

Thyroid frame, detachable for storage in Aesculap Steril Container, see brochure C40402
Strumarahmen, zerlegbar zur Lagerung im Aesculap Sterilcontainer, siehe Prospekt C40401

Dimension for the size of retractors

- Blade size Example: 14 x 17 mm
1st number = depth
2nd number = width
- Rod length Example: 210 mm, 8 1/4"

Maßangaben für die Wundhaken

- Blattgrößen Beispiel: 14 x 17 mm
1. Zahl = Tiefe
2. Zahl = Breite
- Stangenlänge Beispiel: 210 mm, 8 1/4"



BW085R

14 x 17 mm
210 mm, 8 1/4"



BW086R

17 x 16 mm
210 mm, 8 1/4"



BW087R

18 x 22 mm
210 mm, 8 1/4"



BW088R

30 x 19 mm
210 mm, 8 1/4"



BW090R

30 x 20 mm
145 mm, 5 3/4"



BW091R

30 x 40 mm
120 mm, 4 3/4"



BW092R

35 x 11 mm
210 mm, 8 1/4"

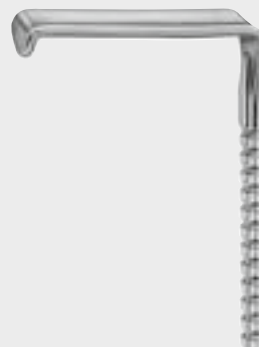

BW093R

55 x 20 mm
145 mm, 5 3/4"



BW094R

51 x 30 mm
120 mm, 4 3/4"

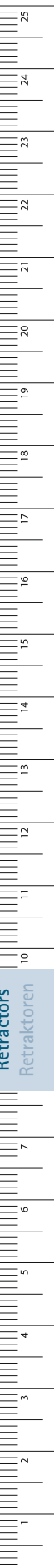

Retractors
Retraktoren

MILLIMETERS

Retractors, Hooks – Retraktoren, Wundhaken

Nerve- and Vessel Hooks

Nerv- und Gefäßhäkchen

Dimensions for blade size of retractors

- 1st number = depth Example: 25 x 38 mm
- 2nd number = width

Maßangaben für Blattgrößen der Wundhaken

- 1. Zahl = Tiefe Beispiel: 25 x 38 mm
- 2. Zahl = Breite

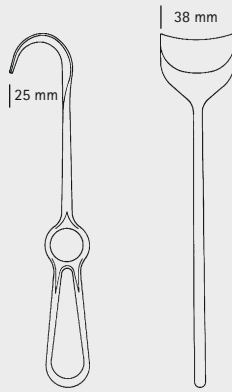

Retractors
Retraktoren

OF282R OF283R OF284R OF285R ^{1/1}

^{1/2}
WAGENER
OF282R-OF285R
150 mm, 6"

OA357R OA358R OA359R ^{1/1}

^{1/2}
GRAEFE
OA357R-OA359R
140 mm, 5 1/2"

^{1/1}

^{1/2}
ST. BARTS
OF288R
Hook, blunt
Ohrhäkchen, stumpf
180 mm, 7"

Retractors, Hooks – Retraktoren, Wundhaken

Nerve- and Vessel Hooks

Nerv- und Gefäßhäkchen



$1/1$

$1/2$

BROM
BT075R
 Vein hook
 Venenhäkchen
 170 mm, 6 $3/4$ "



$1/1$

$1/2$

CRILE
BT080R
 200 mm, 7 $7/8$ "



$1/1$

BT082R **BT083R**

$1/2$

CUSHING
BT082R-BT083R
 190 mm, 7 $1/2$ "

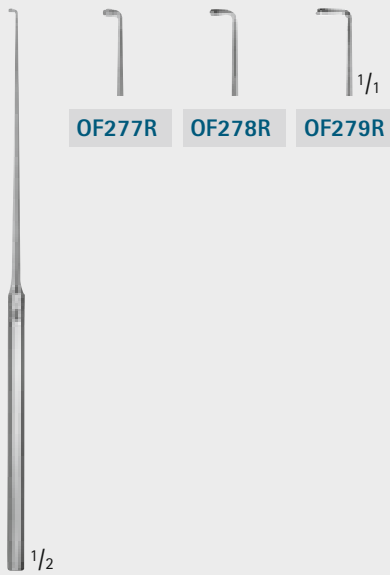

$1/1$

OF277R **OF278R** **OF279R**

$1/2$

LUCAE
OF277R-OF279R
 Ear hooks, probe ended
 Ohrhebel, geknöpft
 140 mm, 5 $1/2$ "



$1/1$

$1/2$

CAWTHORNE
OF276R
 Cerumen hook
 Zerumenhäkchen
 140 mm, 5 $1/2$ "

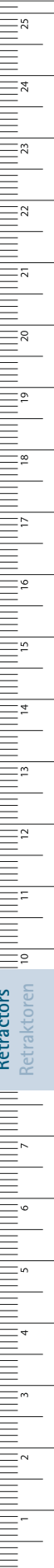

Retractors
Retraktoren

MILLIMETERS

Retractors, Hooks – Retraktoren, Wundhaken

Nerve- and Vessel Hooks

Nerv- und Gefäßhäkchen

Dimensions for blade size of retractors

- 1st number = depth Example: 25 x 38 mm
- 2nd number = width

Maßangaben für Blattgrößen der Wundhaken

- 1. Zahl = Tiefe Beispiel: 25 x 38 mm
- 2. Zahl = Breite

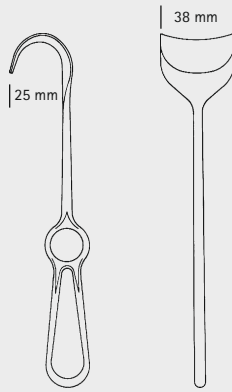

Retractors
Retraktoren

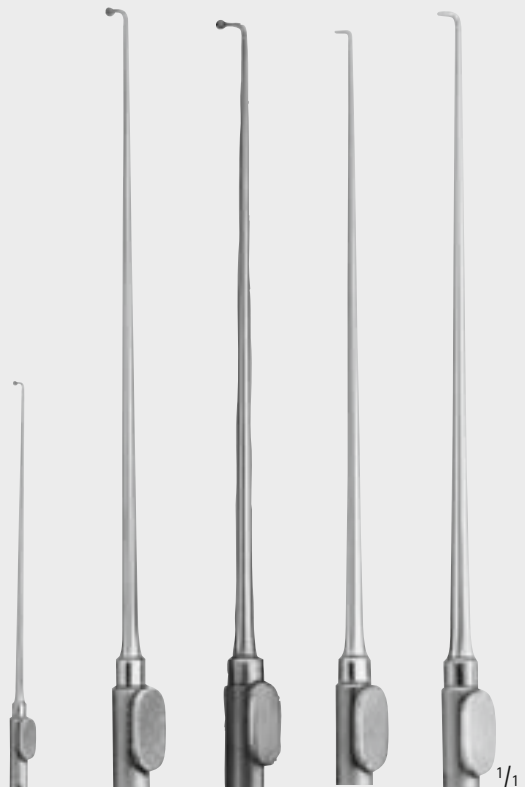

FD396R **FD397R** **FD398R** **FD399R**

$1/2$

KRAYENBÜHL

FD396R-FD399R

185 mm, 7 $1/4$ "



FD394R **FD395R**

blunt
stumpf

sharp
scharf

$1/2$

ADSON

FD394R-FD395R

190 mm, 7 $1/2$ "

Retractors, Hooks – Retraktoren, Wundhaken

Nerve- and Vessel Hooks

Nerv- und Gefäßhäkchen

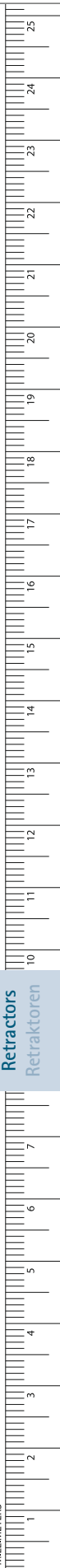

Retractors
Retraktoren

Retractors, Hooks – Retraktoren, Wundhaken

Fine Retractors (Dura- and Skin Retractors)

Feine Wundhäkchen (Dura- und Hauthäkchen)

Dimensions for blade size of retractors

- 1st number = depth Example: 25 x 38 mm
- 2nd number = width

Maßangaben für Blattgrößen der Wundhaken

- 1. Zahl = Tiefe Beispiel: 25 x 38 mm
- 2. Zahl = Breite

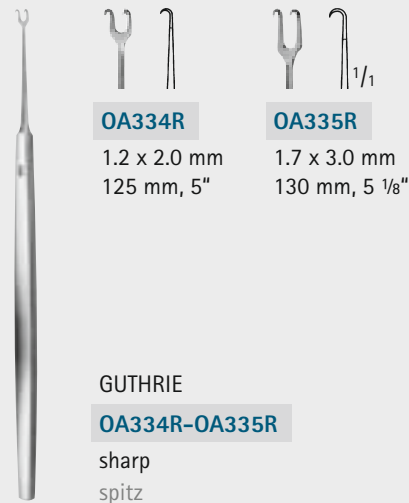
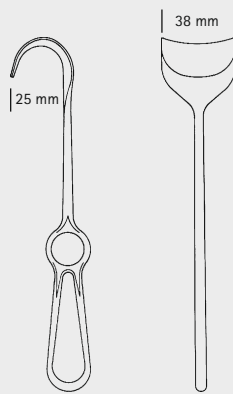

Retractors
Retraktoren

INCHES

Retractors, Hooks – Retraktoren, Wundhaken

Fine Retractors (Dura- and Skin Retractors)

Feine Wundhäkchen (Dura- und Hauthäkchen)

$\frac{1}{2}$

$\frac{1}{1}$

KILNER
OL610R
160 mm, 6 $\frac{1}{4}$ "

9 mm

10 mm

$\frac{1}{1}$

OL615R

OL616R

$\frac{1}{2}$

MC INDOE
OL615R-OL616R
150 mm, 6"

$\frac{1}{1}$

$\frac{1}{1}$

2 x 3.2 mm

$\frac{1}{2}$

FREER
OL621R
150 mm, 6"

$\frac{1}{2}$

$\frac{1}{1}$

MÜLLER
OL626R
150 mm, 6"

$\frac{1}{1}$

$\frac{1}{1}$

2 x 3.2 mm

$\frac{1}{2}$

MÜLLER
OL627R
150 mm, 6"

$\frac{1}{1}$

$\frac{1}{1}$

$\frac{1}{2}$

COTTLE
OL617R
160 mm, 6 $\frac{1}{4}$ "

$\frac{1}{1}$

$\frac{1}{1}$

$\frac{1}{2}$

COTTLE
OL619R
160 mm, 6 $\frac{1}{4}$ "

$\frac{1}{1}$

$\frac{1}{1}$

$\frac{1}{1}$

$\frac{1}{2}$

OL601R **OL602R** **OL603R**

KLEINERT-KUTZ
OL601R-OL603R
160 mm, 6 $\frac{1}{4}$ "

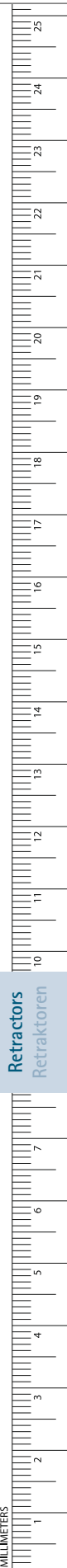

Retractors, Hooks – Retraktoren, Wundhaken

Fine Retractors (Dura- and Skin Retractors)

Feine Wundhäkchen (Dura- und Hauthäkchen)

Dimensions for blade size of retractors

- 1st number = depth Example: 25 x 38 mm
- 2nd number = width

Maßangaben für Blattgrößen der Wundhaken

- 1. Zahl = Tiefe Beispiel: 25 x 38 mm
- 2. Zahl = Breite

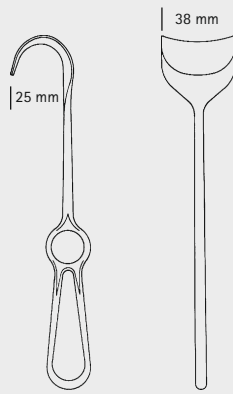

Retractors
Retraktoren



JÄGER
OA351R
135 mm, 5 1/4"

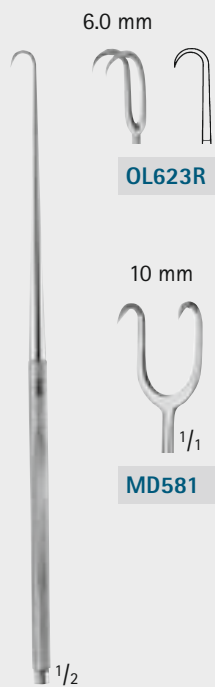

JOSEPH
OL620R-MD581
165 mm, 6 1/2"



GILLIES
OL611R-OL612R
180 mm, 7"



BT120R
175 mm, 6 7/8"

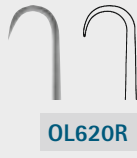

OL620R

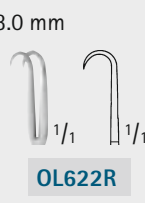

OL622R

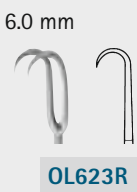

OL623R

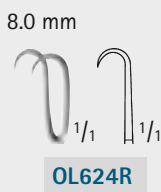

OL624R



MD581



Retractors, Hooks – Retraktoren, Wundhaken

Fine Retractors (Dura- and Skin Retractors)

Feine Wundhäkchen (Dura- und Hauthäkchen)

$\frac{1}{2}$

$\frac{1}{1}$

BARSKY
OL614R
155 mm, 6 $\frac{1}{8}$ "

$\frac{1}{2}$

$\frac{1}{1}$

FD375R
Dura retractor
Durahäkchen
185 mm, 7 $\frac{1}{4}$ "

$\frac{1}{2}$

$\frac{1}{1}$

FISCH
FD376R
Dura retractor
Durahäkchen
185 mm, 7 $\frac{1}{4}$ "

3 x 11 mm

$\frac{1}{2}$

$\frac{1}{1}$

KILNER
OL206R
sharp
spitz
80 mm, 3 $\frac{1}{8}$ "

7 x 12 mm

$\frac{1}{2}$

$\frac{1}{1}$

8 x 12 mm

CONVERSE
OL207R
blunt
stumpf
120 mm, 4 $\frac{3}{4}$ "

$\frac{1}{2}$

$\frac{1}{1}$
diam. 1.8 mm
Ø 1,8 mm

Double picks to grasp and lift skin, tissue etc.
Doppelkrallen zum Fassen und Anheben von Haut, Gewebe etc.

Protector for storing and sterilization
Schutzhülse zur Lagerung und Sterilisation

FD392R
Tissue pick
Gewebekralle
185 mm, 7 $\frac{1}{4}$ "

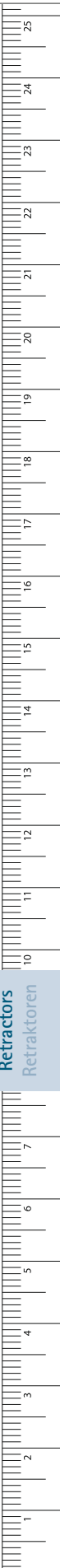

Retractors, Hooks – Retraktoren, Wundhaken

Trachea Retractors

Wund- und Trachealhäkchen

Dimensions for blade size of retractors

- 1st number = depth Example: 25 x 38 mm
- 2nd number = width

Maßangaben für Blattgrößen der Wundhaken

- 1. Zahl = Tiefe Beispiel: 25 x 38 mm
- 2. Zahl = Breite

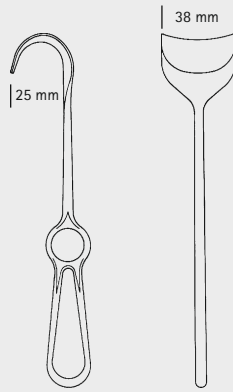

7 mm



BERGMANN

BT100R

140 mm, 5 1/2"



BOSE

FA025R

165 mm, 6 1/2"



BOSE

FA026R

165 mm, 6 1/2"



BT103R

sharp
scharf

BT106R

blunt
stumpf

BT107R

blunt
stumpf

BT103R–BT107R

180 mm, 7"

Retractors, Hooks – Retraktoren, Wundhaken

Trachea Retractors

Wund- und Trachealhäkchen



BT132R
3.5 x 4.5 mm

BT133R
4 x 7.2 mm

BT134R
4 x 10 mm

BT132R–BT134R
flexible shaft, sharp
flexibler Schaft, scharf
155 mm, 6 1/8"

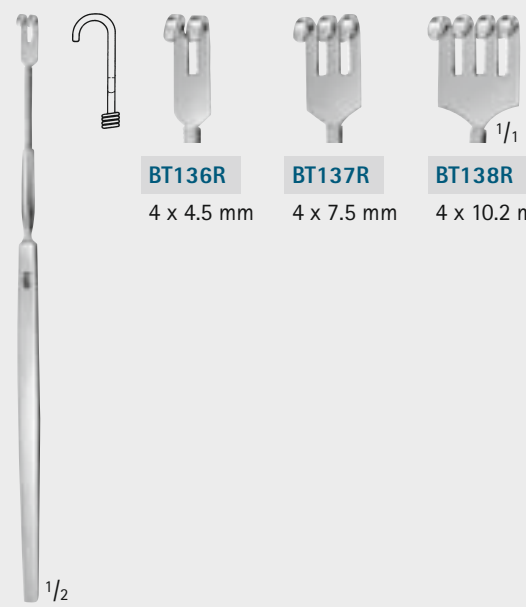

BT136R
4 x 4.5 mm

BT137R
4 x 7.5 mm

BT138R
4 x 10.2 mm

BT136R–BT138R
flexible shaft, blunt
flexibler Schaft, stumpf
155 mm, 6 1/8"

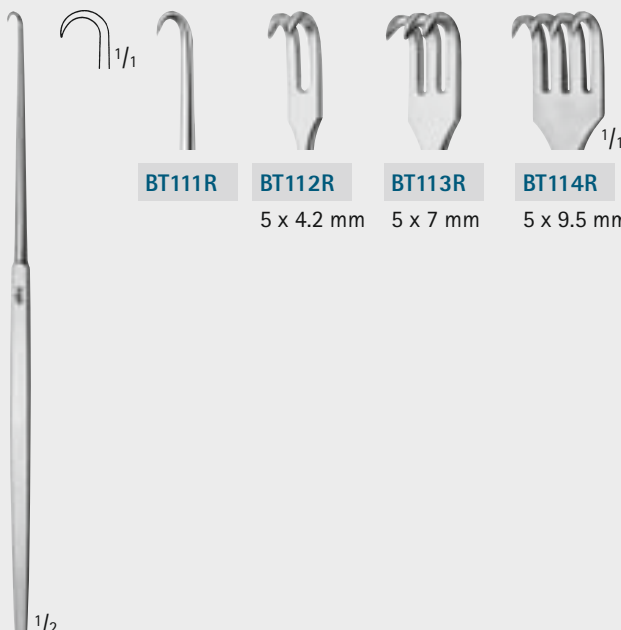

BT111R
5 x 4.2 mm

BT112R
5 x 7 mm

BT113R
5 x 7 mm

BT114R
5 x 9.5 mm

BT111R–BT114R
small curve, sharp
enge Biegung, scharf
165 mm, 6 1/2"

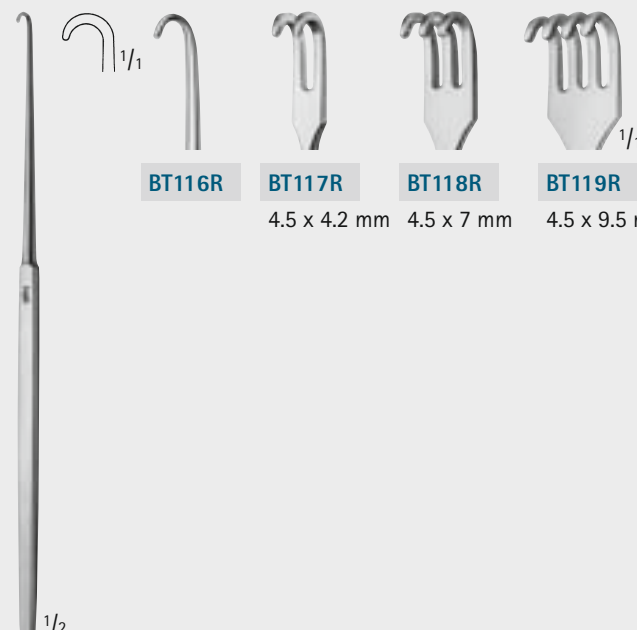

BT116R
4.5 x 4.2 mm

BT117R
4.5 x 7 mm

BT118R
4.5 x 7 mm

BT119R
4.5 x 9.5 mm

BT116R–BT119R
small curve, blunt
enge Biegung, stumpf
165 mm, 6 1/2"

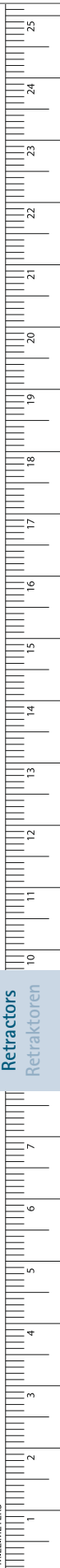

Retractors, Hooks – Retraktoren, Wundhaken

Trachea Retractors

Wund- und Trachealhäkchen

Dimensions for blade size of retractors

- 1st number = depth Example: 25 x 38 mm
- 2nd number = width

Maßangaben für Blattgrößen der Wundhaken

- 1. Zahl = Tiefe Beispiel: 25 x 38 mm
- 2. Zahl = Breite

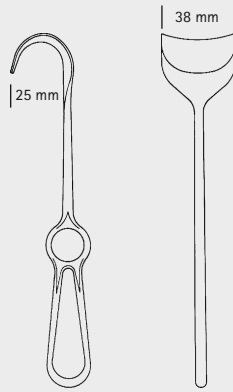

Retractors
Retraktoren

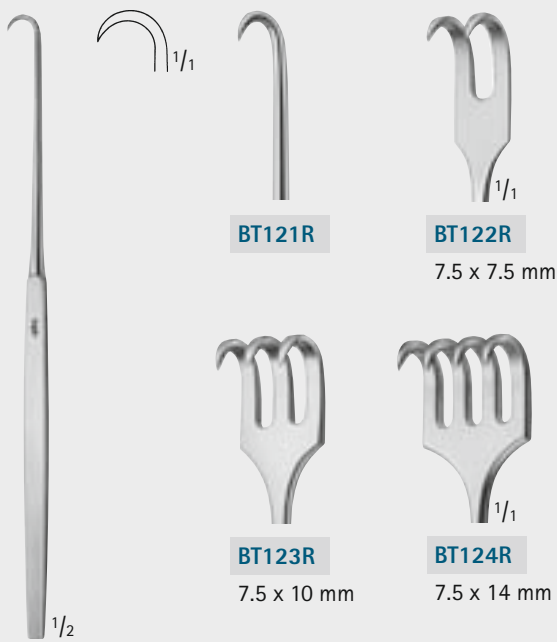

BT121R–BT124R
large curve, sharp
weite Biegung, scharf
165 mm, 6 1/2"

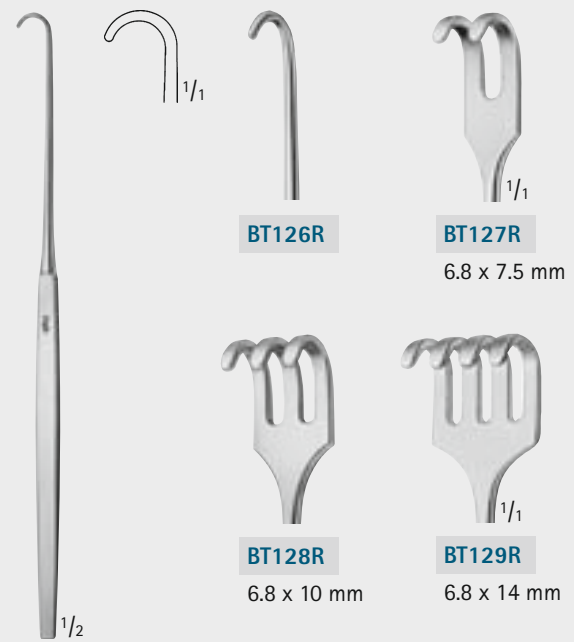

BT126R–BT129R
large curve, blunt
weite Biegung, stumpf
165 mm, 6 1/2"

Retractors, Hooks – Retraktoren, Wundhaken

Retractors with Treangle Handle

Wundhaken mit Treangle-Griff

MANNERFELT MODIF.
BT901R
 sharp
 scharf
 135 mm, 5 1/4"

MANNERFELT MODIF.
BT902R
 sharp
 scharf
 155 mm, 6 1/8"

MANNERFELT MODIF.
BT904R
 hollow grooved
 hohlgekehlt
 155 mm, 6 1/8"
 3.5 x 12 mm

MANNERFELT MODIF.
BT906R
 Forked hook, retrogradely curved
 Gabelhaken, retrograd gebogen
 155 mm, 6 1/8"
 8 x 12.5 mm

MANNERFELT MODIF.
BT911R-BT913R
 small curve, sharp
 enge Biegung, scharf
 155 mm, 6 1/8"

BT911R

BT912R
 5 x 4 mm

BT913R
 5.5 x 7.2 mm

MANNERFELT MODIF.
BT916R-BT918R
 small curve, blunt
 enge Biegung, stumpf
 155 mm, 6 1/8"

BT916R

BT917R
 5.5 x 4 mm

BT918R
 5.5 x 7.2 mm

MANNERFELT MODIF.
BT921R-BT923R
 large curve, sharp
 weite Biegung, scharf
 155 mm, 6 1/8"

BT921R

BT922R
 8 x 8 mm

BT923R
 7 x 11 mm

MANNERFELT MODIF.
BT926R-BT928R
 large curve, blunt
 weite Biegung, stumpf
 155 mm, 6 1/8"

BT926R

BT927R
 7 x 8 mm

BT928R
 7 x 11 mm

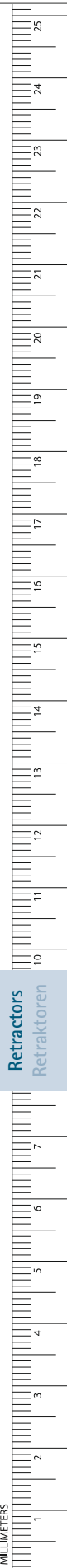

Retractors, Hooks – Retraktoren, Wundhaken

Alar Retractors

Nasenflügelretraktoren

Dimensions for blade size of retractors

- 1st number = depth Example: 25 x 38 mm
- 2nd number = width

Maßangaben für Blattgrößen der Wundhaken

- 1. Zahl = Tiefe Beispiel: 25 x 38 mm
- 2. Zahl = Breite

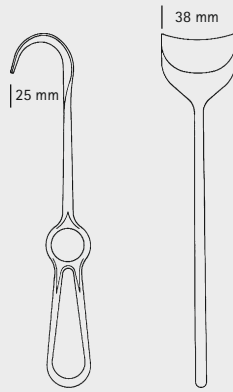

FOMON
OL202R
Alar retractor, 2 prongs, blunt/blunt
Nasenflügelretractor, 2 zinkig, stumpf/stumpf
145 mm, 5 3/4"

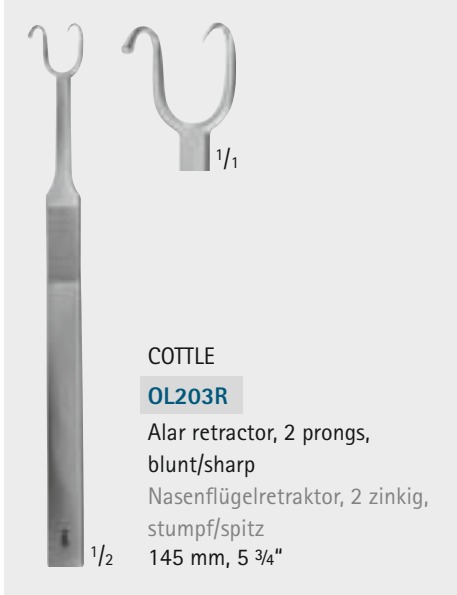

COTTLE
OL203R
Alar retractor, 2 prongs, blunt/sharp
Nasenflügelretractor, 2 zinkig, stumpf/spitz
145 mm, 5 3/4"



COTTLE
OL204R
Alar retractor, 2 prongs, sharp/blunt
Nasenflügelretractor, 2 zinkig, spitz/stumpf
145 mm, 5 3/4"



COTTLE
OL214R
Alar retractor, with saw and knife guide, 2 prongs, blunt/blunt
Nasenflügelretractor, mit Säge- oder Messerführung, 2 zinkig, stumpf/stumpf
200 mm, 7 7/8"

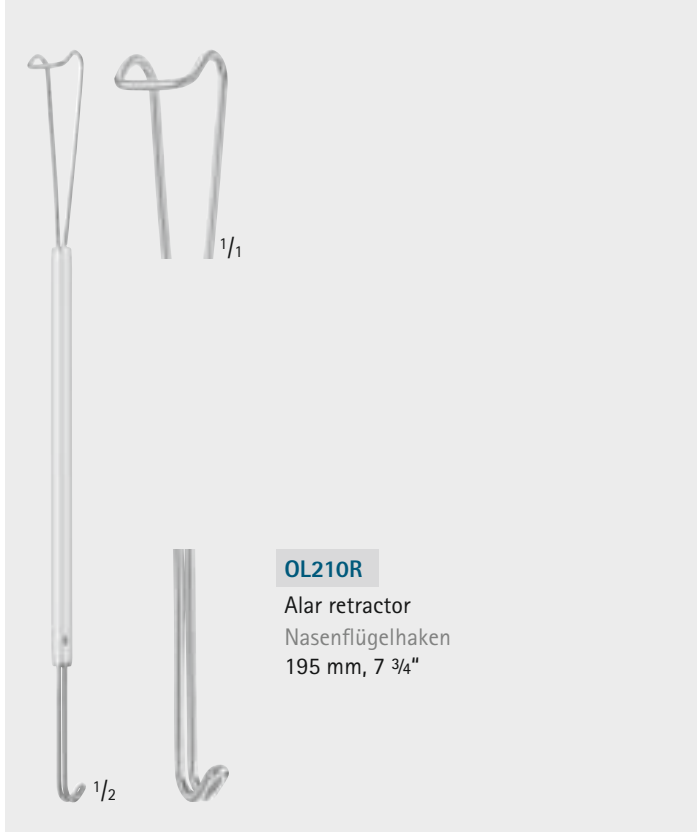

COTTLE
OL210R
Alar retractor
Nasenflügelhaken
195 mm, 7 3/4"

Retractors
Retraktoren

INCHES

Retractors, Hooks – Retraktoren, Wundhaken

Retractors with Treangle Handle

Wundhaken mit Treangle Griff



MANNERFELT MODIF.

BT933R

flexible shaft,
small curve, sharp
flexibler Schaft,
enge Biegung, scharf
155 mm, 6 1/8"

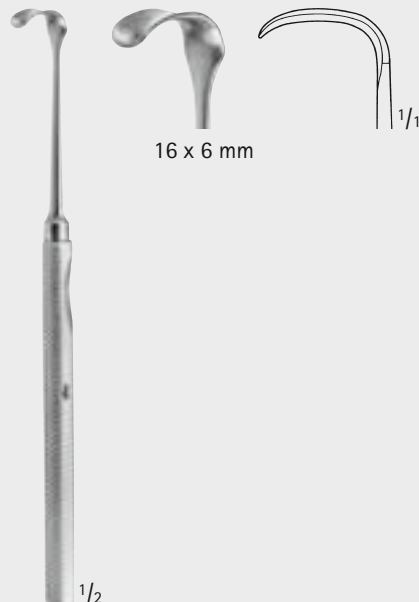

MANNERFELT MODIF.

BT940R

hollow grooved
hohlgekehlt
155 mm, 6 1/8"



LANGENBECK-MANNERFELT MODIF.

BT943R-BT946R

155 mm, 6 1/8"

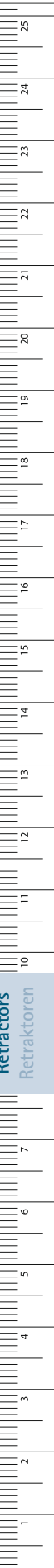

Retractors
Retraktoren

MILLIMETERS

Retractors, Hooks – Retraktoren, Wundhaken

Retractors with Treangle Handle

Wundhaken mit Treangle Griff

Dimensions for blade size of retractors

- 1st number = depth Example: 25 x 38 mm
- 2nd number = width

Maßangaben für Blattgrößen der Wundhaken

- 1. Zahl = Tiefe Beispiel: 25 x 38 mm
- 2. Zahl = Breite

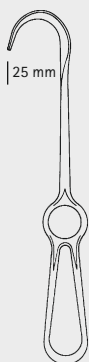

BT948R

12 x 12 mm



BT949R

12 x 14 mm



BT951R

14 x 16 mm

MANNERFELT MODIF.

BT948R–BT951R

Saddle hooks

Sattelhaken

155 mm, 6 1/8"



12 x 12 mm

1/2

MANNERFELT MODIF.

BT958R

Saddle hooks, fenestrated

Sattelhaken, gefenstert

155 mm, 6 1/8"

Retractors
Retraktoren

INCHES

Retractors, Hooks – Retraktoren, Wundhaken

Retractors Wundhaken



BT173R

BT174R

BT173R–BT174R

160 mm, 6 1/4"



BT177R

BT178R

LANGENBECK-GREEN

BT177R–BT178R

160 mm, 6 1/4"



BT179R

160 mm, 6 1/4"

10 x 13 mm

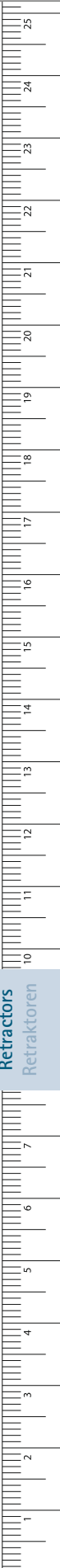

Retractors
Retraktoren

Retractors, Hooks – Retraktoren, Wundhaken

Retractors

Wundhaken

Dimensions for blade size of retractors

- 1st number = depth Example: 25 x 38 mm
- 2nd number = width

Maßangaben für Blattgrößen der Wundhaken

- 1. Zahl = Tiefe Beispiel: 25 x 38 mm
- 2. Zahl = Breite

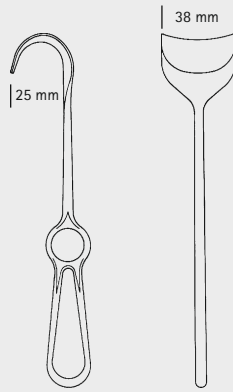

BT193R

Fig. A
18 x 7 mm



BT194R

Fig. B
16 x 5 mm



BT196R

Fig. D
5 x 10 mm



BT197R

Fig. E
11 x 4 mm



BT198R

Fig. F
6 x 4 mm



BT195R

Fig. C
7 x 4 mm



MEYERDING

BT193R-BT198R

180 mm, 7"

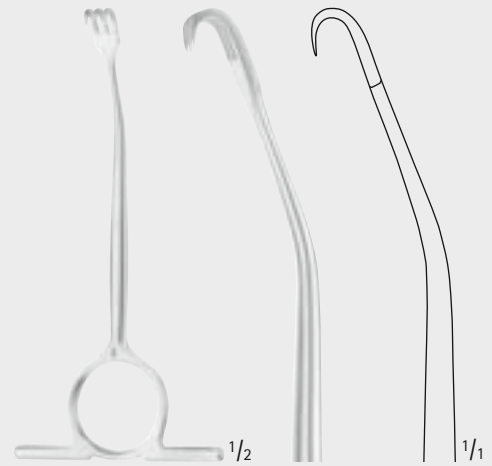

WILLIGER

DO404R

sharp
scharf
120 mm, 4 3/4"

Retractors
Retraktoren

INCHES

Retractors, Hooks – Retraktoren, Wundhaken

Retractors Wundhaken



¹/₂

¹/₁

EMMET
BT161R
Fistula hook
Fistelhaken
220 mm, 8 3/4"



¹/₂

¹/₁

SIMON
BT166R
Fistula hook
Fistelhaken
220 mm, 8 3/4"



¹/₂

¹/₁

SIMON
BT167R
Fistula hook
Fistelhaken
220 mm, 8 3/4"



¹/₂

¹/₁

LANGE
OL201R
Fistula hook
Fistelhaken
235 mm, 9 1/4"

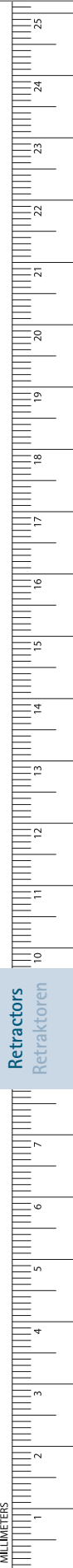

Retractors, Hooks – Retraktoren, Wundhaken

Retractors

Wundhaken

Dimensions for blade size of retractors

- 1st number = depth Example: 25 x 38 mm
- 2nd number = width

Maßangaben für Blattgrößen der Wundhaken

- 1. Zahl = Tiefe Beispiel: 25 x 38 mm
- 2. Zahl = Breite

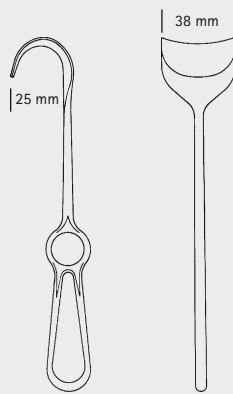

Retractors
Retraktoren

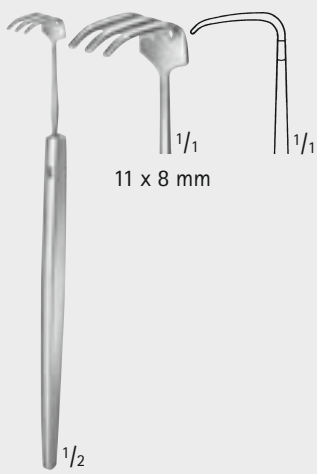

PAUL

OA340R

Tendon hook
Sehnenscheidenhaken
120 mm, 4 3/4"

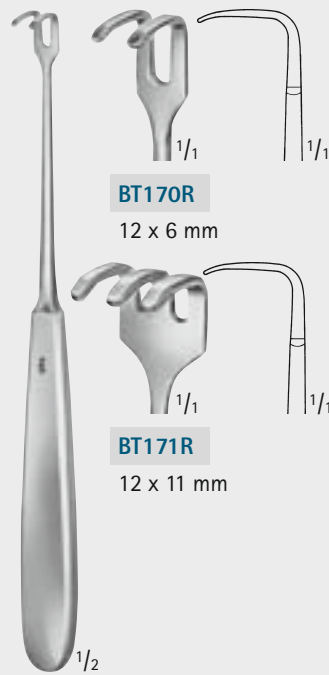

BT170R

12 x 6 mm

BT171R

12 x 11 mm

BT170R-BT171R

Tendon hook
Sehnenscheidenhaken
175 mm, 6 7/8"

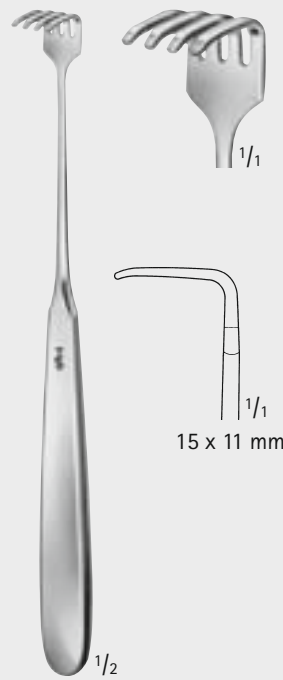

KLAPP

BT172R

Tendon hook
Sehnenscheidenhaken
175 mm, 6 7/8"

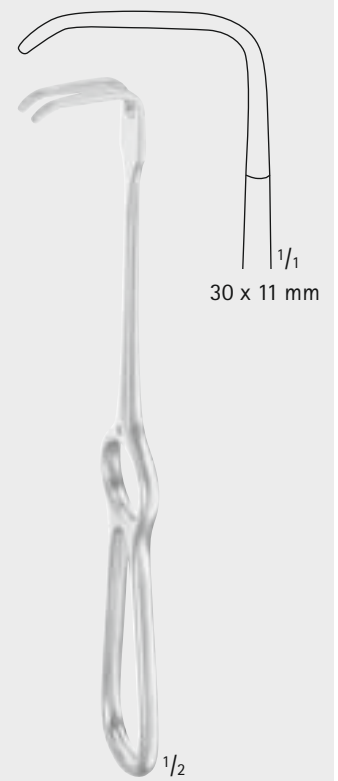

BT169R

Parotis hook
Parotishaken
185 mm, 7 1/4"

Retractors, Hooks – Retraktoren, Wundhaken

Retractors Wundhaken

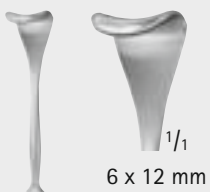

MASING
OL211R
140 mm, 5 1/2"



COTTLE
OL212R
140 mm, 5 1/2"



DESMARRES
OA310R-OA314R
140 mm, 5 1/2"



STRANDELL-STILLE
BT180R-BT181R
180 mm, 7"

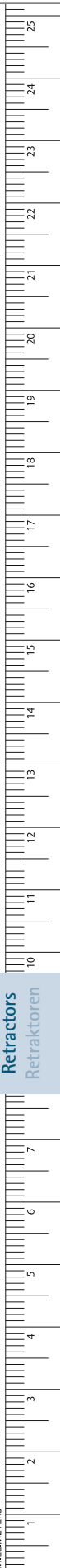

Retractors
Retraktoren

Retractors, Hooks – Retraktoren, Wundhaken

Vein Retractors

Wund- und Venenhaken

Dimensions for blade size of retractors

- 1st number = depth Example: 25 x 38 mm
- 2nd number = width

Maßangaben für Blattgrößen der Wundhaken

- 1. Zahl = Tiefe Beispiel: 25 x 38 mm
- 2. Zahl = Breite

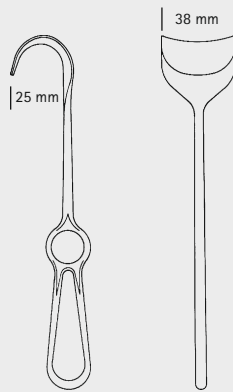

KÖNIG
BT182R-BT183R
180 mm, 7"



CUSHING-KOCHER
BT190R
175 mm, 6 7/8"



KOCHER
BT457R-BT458R
205 mm, 8"

Retractors
Retraktoren

INCHES

Retractors, Hooks – Retraktoren, Wundhaken

Vein Retractors

Wund- und Venenhaken



13 x 6 mm

1/2

SCHOENBORN

BT192R

200 mm, 7 7/8"



25 x 10 mm

1/2

BT199R

Thyroid hook
Schilddrüsenhaken
220 mm, 8 3/4"



BT184R

10 x 13 mm



BT185R

14 x 18 mm

1/2

CUSHING

BT184R-BT185R

205 mm, 8"

20 x 15 mm



1/2

20 x 19 mm

BT187R

205 mm, 8"

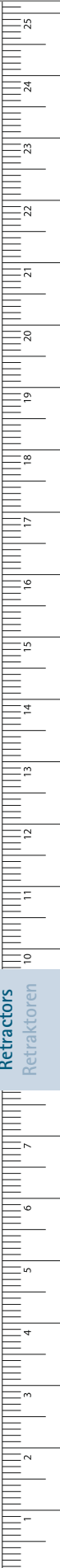

Retractors
Retraktoren

MILLIMETERS

Retractors, Hooks – Retraktoren, Wundhaken

Retractors

Wundhaken

Dimensions for blade size of retractors

- 1st number = depth Example: 25 x 38 mm
- 2nd number = width

Maßangaben für Blattgrößen der Wundhaken

- 1. Zahl = Tiefe Beispiel: 25 x 38 mm
- 2. Zahl = Breite

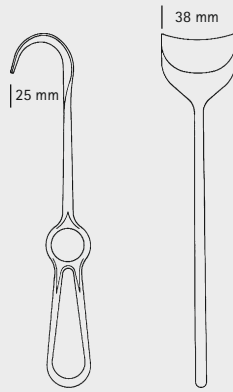

5 x 10 mm



1/2

1/1

1/1

13 x 5 mm

KILNER

BT005R

165 mm, 6 1/2"

8 x 7 mm

8 x 7 mm

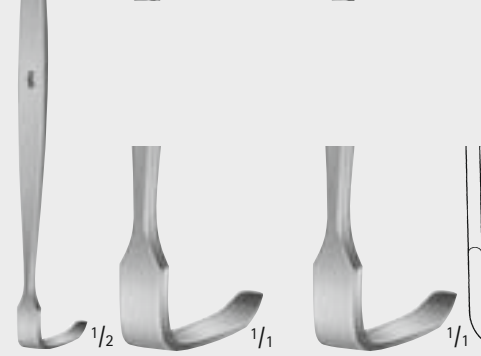
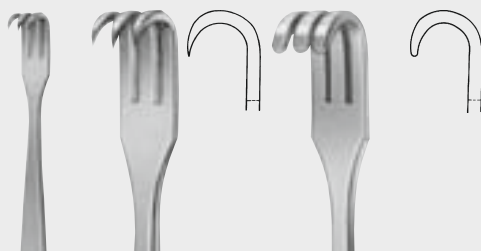

1/2

1/1

1/1

22 x 7 mm

22 x 7 mm

BT006R

BT007R

BABY-SENN-MILLER

BT006R-BT007R

155 mm, 6 1/8"

8 x 7 mm

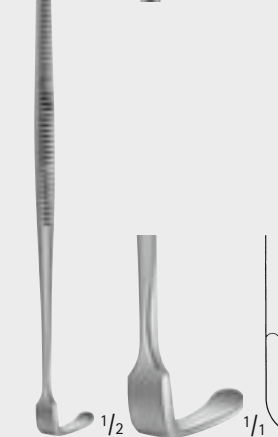
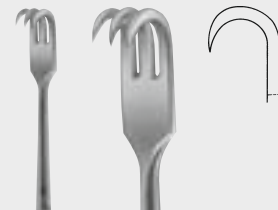

1/2

1/1

1/1

18 x 5.5 mm

SENN-MILLER

BT008R

165 mm, 6 1/2"

Retractors
Retraktoren

INCHES

Retractors, Hooks – Retraktoren, Wundhaken

Retractors

Wundhaken

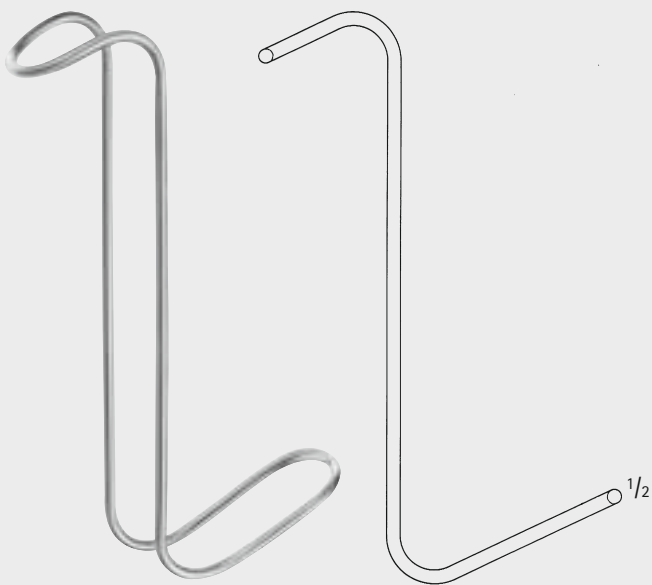

COLLIN-HARTMANN

BT001R

150 mm, 6"

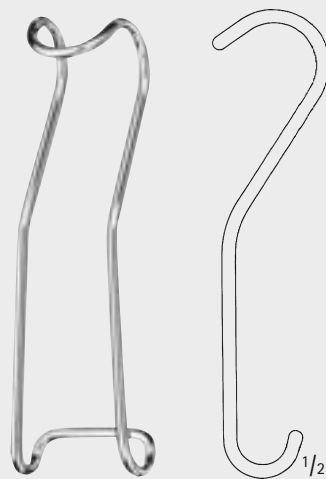

STERNBERG

Art. No.	Length
Art. Nr.	Länge
OM251R	120 mm, 4 3/4"
OM252R	130 mm, 5 1/8"
OM253R	135 mm, 5 1/4"

Retractors
Retraktoren

MILLIMETERS

Retractors, Hooks – Retraktoren, Wundhaken

Retractors

Wundhaken

Dimensions for blade size of retractors

- 1st number = depth Example: 25 x 38 mm
- 2nd number = width

Maßangaben für Blattgrößen der Wundhaken

- 1. Zahl = Tiefe Beispiel: 25 x 38 mm
- 2. Zahl = Breite

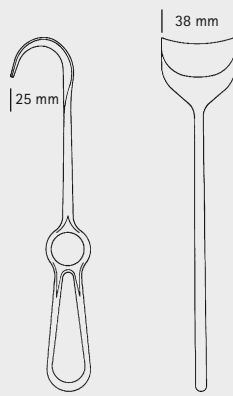

Retractors
Retraktoren

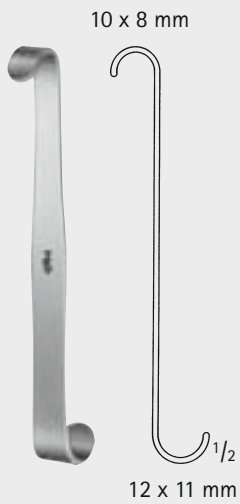

LUER
BT010R
110 mm, 4 1/4"

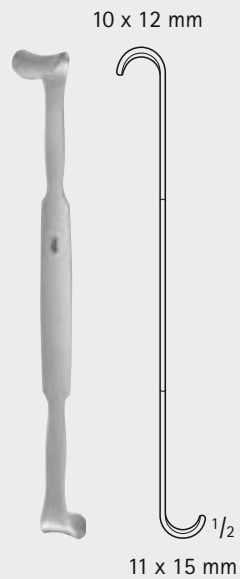

ROSE
BT011R
130 mm, 5 1/8"

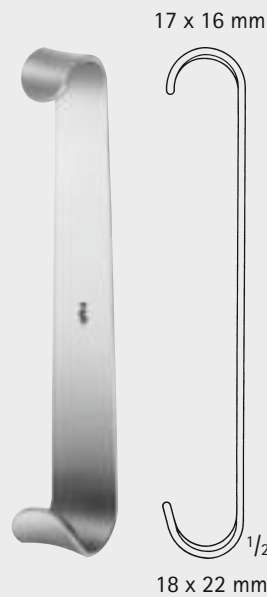

BABY-ROUX
BT019R
135 mm, 5 1/4"

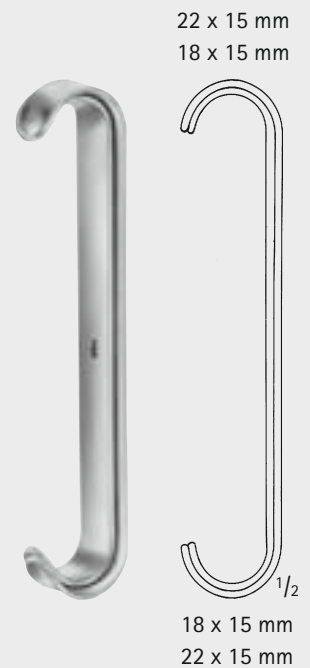

PARKER
BT025R
135 mm, 5 1/4"

Retractors, Hooks – Retraktoren, Wundhaken

Retractors Wundhaken

5 x 3 mm



14 x 6.3 mm

RAGNELL
BT004R

150 mm, 6"

11 x 4 mm

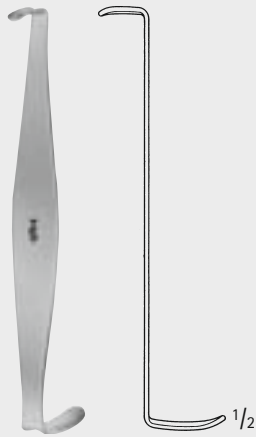

19 x 6 mm

CRILE
BT012R

110 mm, 4 1/4"

25 x 10 mm
22 x 10 mm

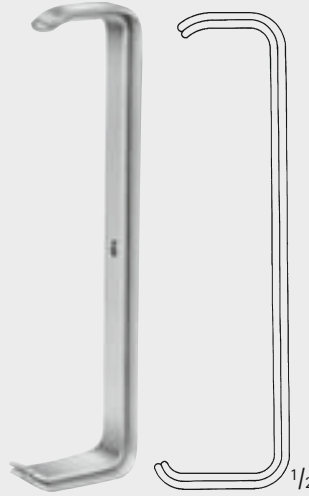

29 x 12 mm
32 x 12 mm

FARABEUF
BT020R

125 mm, 5"

23 x 16 mm
19 x 16 mm

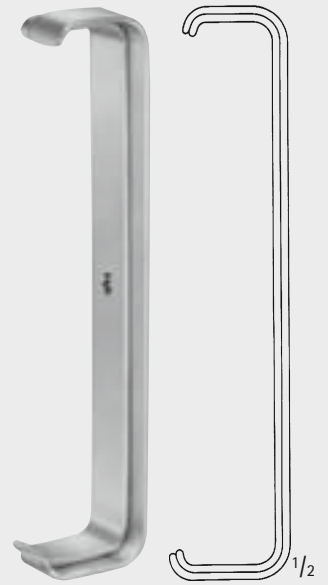

24 x 16 mm
28 x 16 mm

FARABEUF
BT021R

150 mm, 6"

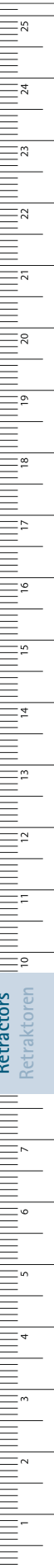

Retractors
Retraktoren

Retractors, Hooks – Retraktoren, Wundhaken

Retractors

Wundhaken



Dimensions for blade size of retractors

- 1st number = depth Example: 25 x 38 mm
- 2nd number = width

Maßangaben für Blattgrößen der Wundhaken

- 1. Zahl = Tiefe Beispiel: 25 x 38 mm
- 2. Zahl = Breite

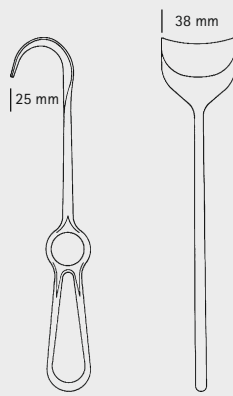

31 x 25 mm
27 x 25 mm



27 x 25 mm
31 x 25 mm

PARKER

BT026R

180 mm, 7"

21 x 14 mm
17 x 14 mm

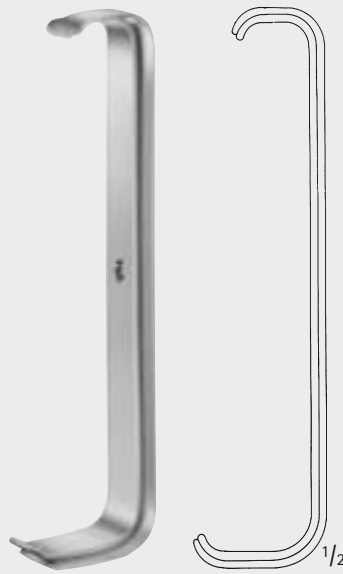

28 x 16 mm
32 x 16 mm

COLLIN

BT022R

150 mm, 6"

Retractors, Hooks – Retraktoren, Wundhaken

Retractors Wundhaken



ROUX

BT030R–BT033R

Set complete, consisting of:
Satz komplett, bestehend aus:
BT031R
BT032R
BT033R

21 x 22 mm



27 x 28 mm

BT031R

145 mm, 5 3/4"

26 x 26 mm



32 x 36 mm

BT032R

155 mm, 6 1/8"

30 x 30 mm



36 x 44 mm

BT033R

165 mm, 6 1/2"

28 x 24 mm

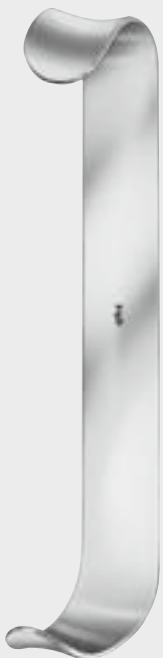

ROUX

BT028R

170 mm, 6 3/4"

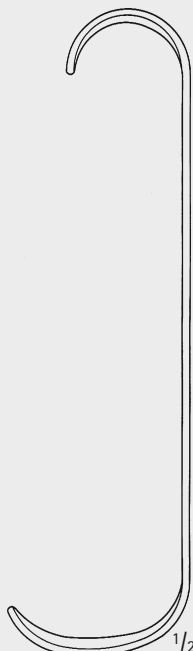

43 x 24 mm

28 x 28 mm



ROUX

BT029R

190 mm, 7 1/2"

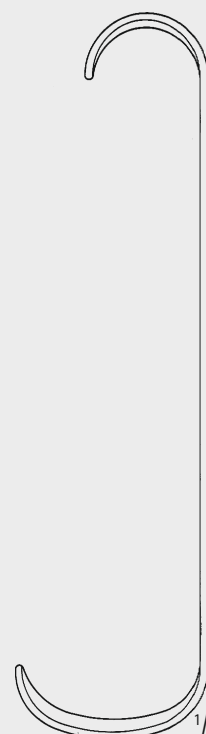

46 x 28 mm

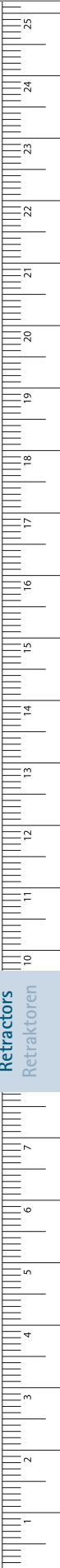

Retractors
Retraktoren

MILLIMETERS

Retractors, Hooks – Retraktoren, Wundhaken

Retractors

Wundhaken



Dimensions for blade size of retractors

- 1st number = depth Example: 25 x 38 mm
- 2nd number = width

Maßangaben für Blattgrößen der Wundhaken

- 1. Zahl = Tiefe Beispiel: 25 x 38 mm
- 2. Zahl = Breite

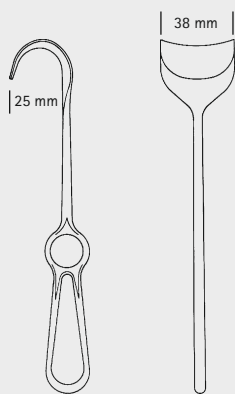

30 x 19 mm

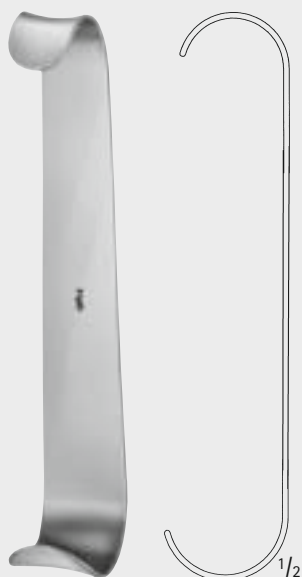

33 x 25 mm

KILNER

OL219R

150 mm, 6"

35 x 29 mm

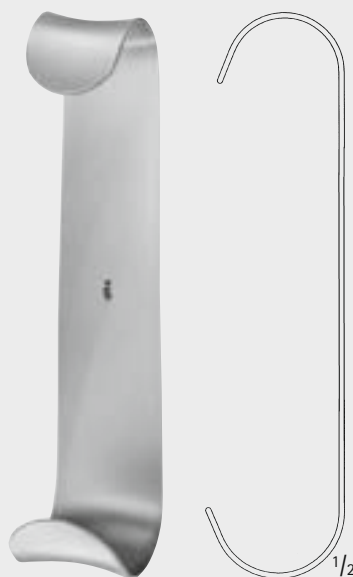

40 x 35 mm

KILNER

OL220R

150 mm, 6"

Retractors, Hooks – Retraktoren, Wundhaken

Retractors Wundhaken

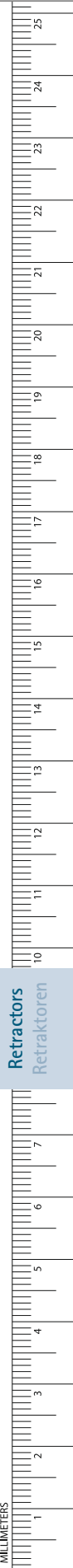
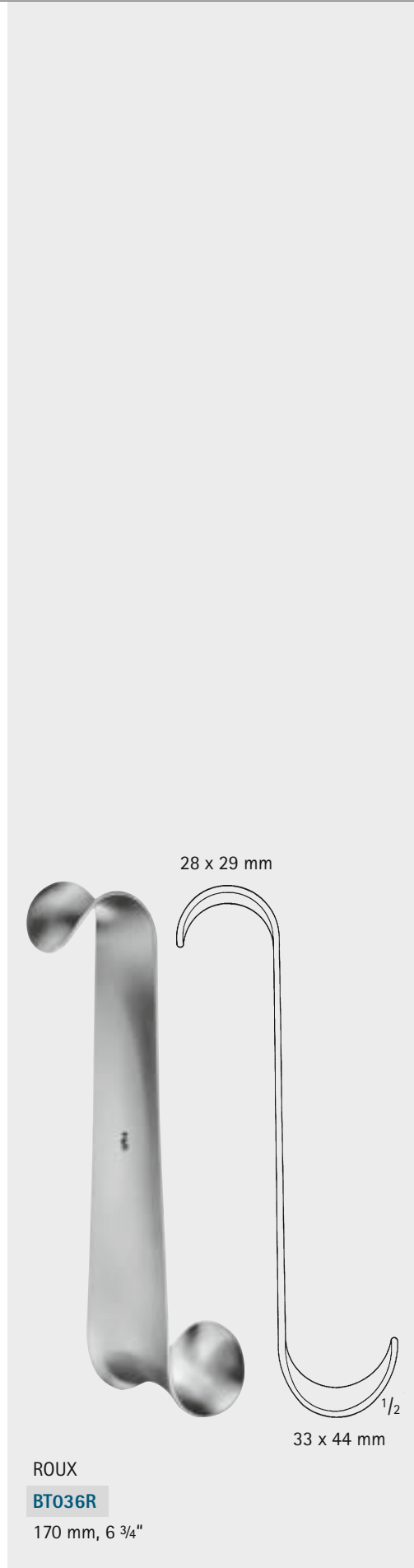
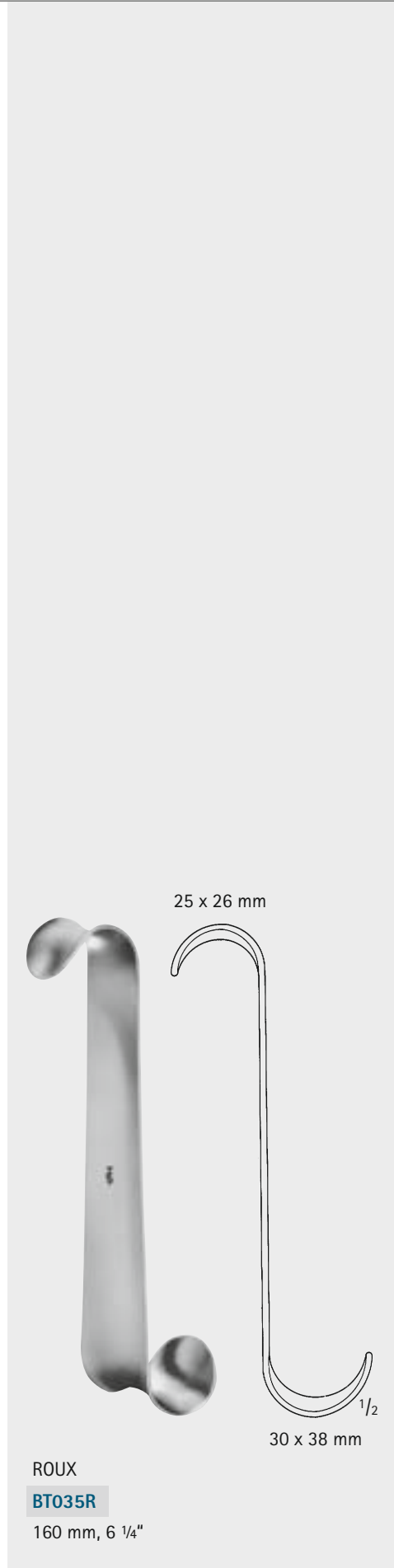
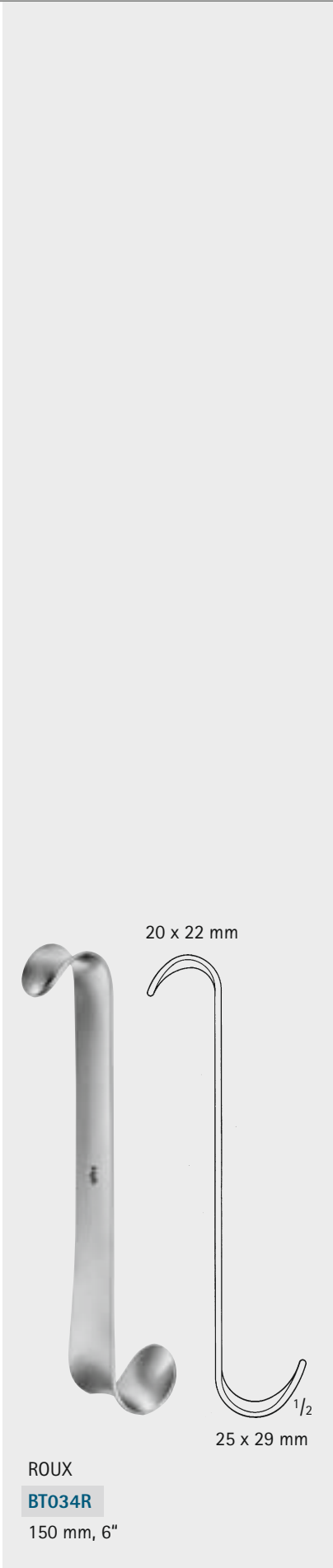

Retractors, Hooks – Retraktoren, Wundhaken

Retractors

Wundhaken

Dimensions for blade size of retractors

- 1st number = depth Example: 25 x 38 mm
- 2nd number = width

Maßangaben für Blattgrößen der Wundhaken

- 1. Zahl = Tiefe Beispiel: 25 x 38 mm
- 2. Zahl = Breite

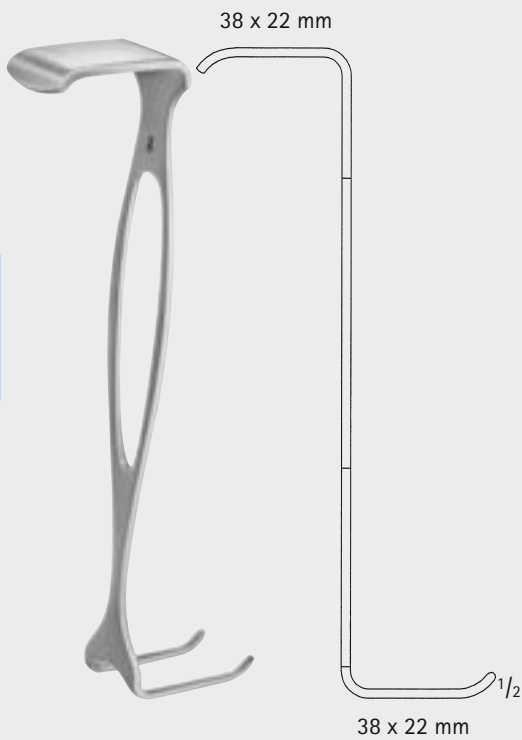
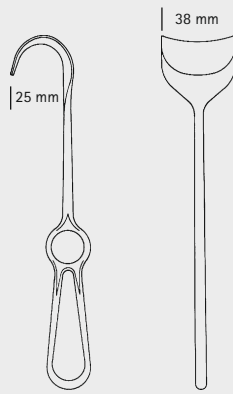

CZERNY
BT042R
175 mm, 6 7/8"

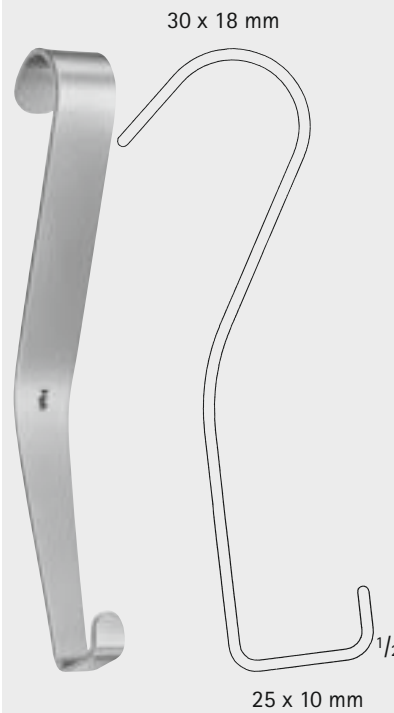

HAJEK
OL221R
165 mm, 6 1/2"

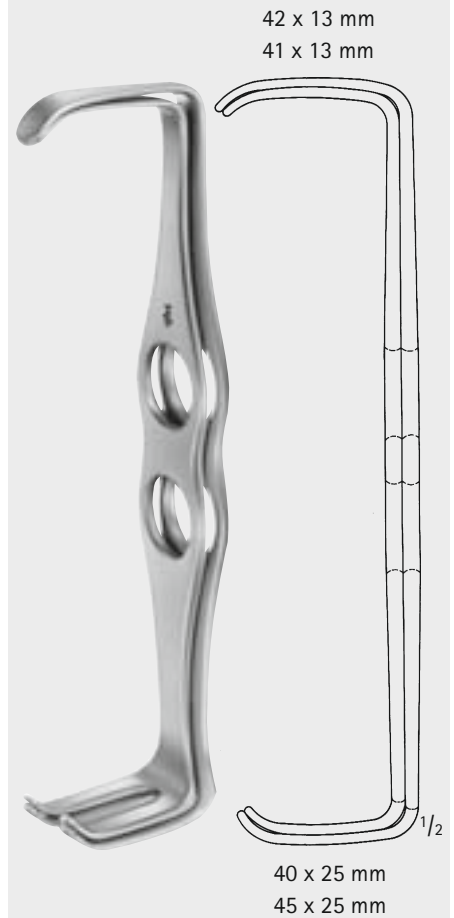

MATHIEU
BT040R
200 mm, 7 7/8"

Retractors
Retraktoren

INCHES

Retractors, Hooks – Retraktoren, Wundhaken

Retractors Wundhaken

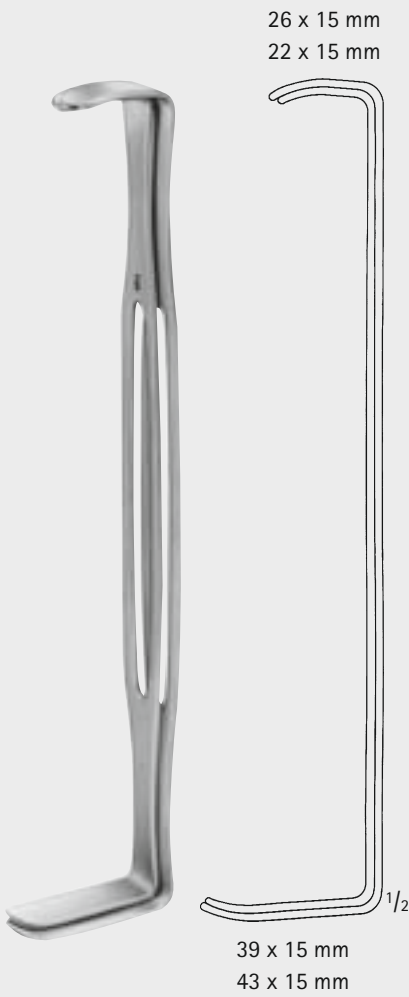

US-ARMY

BT041R

220 mm, 8 3/4"



GOELET

MD497

190 mm, 7 1/2"

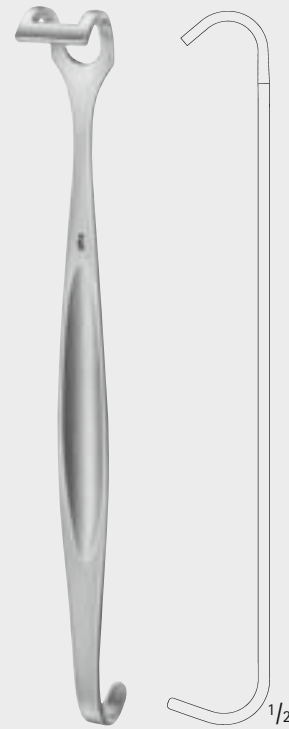

CANNY-RYALL

Art. No.	Width (mm)	Length
Art. Nr.	Breite (mm)	Länge
BT047R	16	190 mm, 7 1/2"
BT048R	20	190 mm, 7 1/2"
BT049R	25	200 mm, 7 7/8"

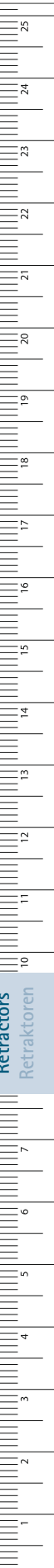

Retractors
Retraktoren

MILLIMETERS

Retractors, Hooks – Retraktoren, Wundhaken

Bone Retractors and Retractors

Knochen- und Wundhaken

Dimensions for blade size of retractors

- 1st number = depth Example: 25 x 38 mm
- 2nd number = width

Maßangaben für Blattgrößen der Wundhaken

- 1. Zahl = Tiefe Beispiel: 25 x 38 mm
- 2. Zahl = Breite

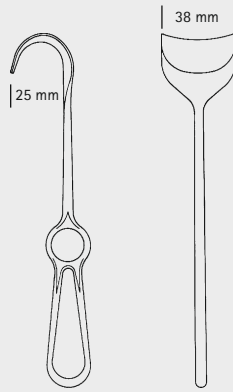

Retractors
Retraktoren

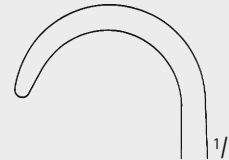
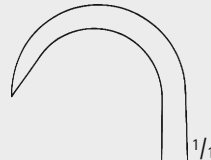
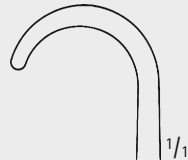
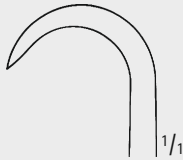
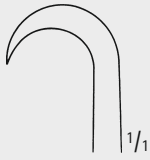

KOCHER
BT234R
sharp
scharf
205 mm, 8"



KOCHER
BT238R
sharp
scharf
220 mm, 8 3/4"



KOCHER
BT239R
blunt
stumpf
220 mm, 8 3/4"



VOLKMANN
BT240R
sharp
scharf
220 mm, 8 3/4"



VOLKMANN
BT241R
blunt
stumpf
220 mm, 8 3/4"



BT232R
sharp
scharf
245 mm, 9 5/8"

Retractors, Hooks – Retraktoren, Wundhaken

Bone Retractors and Retractors

Knochen- und Wundhaken



VOLKMANN

BT221R

sharp
scharf
220 mm, 8 3/4"

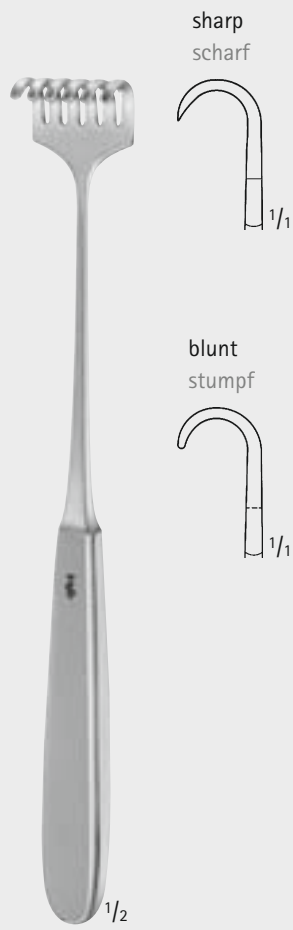

VOLKMANN

BT222R–BT230R

225 mm, 8 7/8"

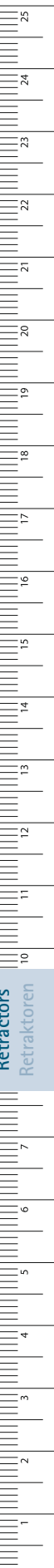
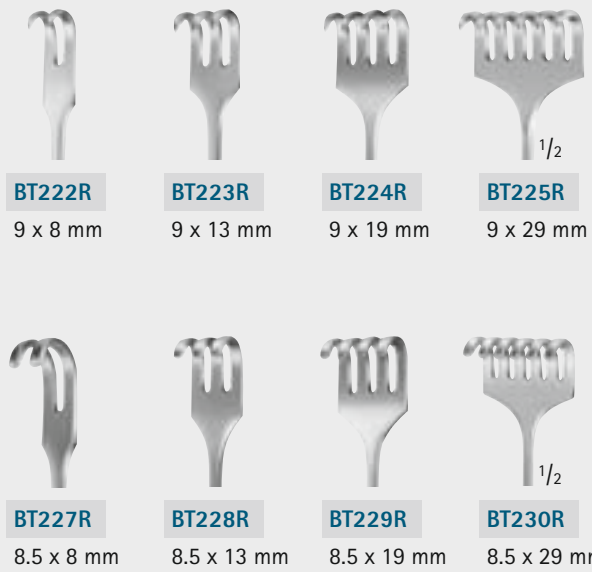

Retractors
Retraktoren

Retractors, Hooks – Retraktoren, Wundhaken

Retractors

Wundhaken

Dimensions for blade size of retractors

- 1st number = depth Example: 25 x 38 mm
- 2nd number = width

Maßangaben für Blattgrößen der Wundhaken

- 1. Zahl = Tiefe Beispiel: 25 x 38 mm
- 2. Zahl = Breite

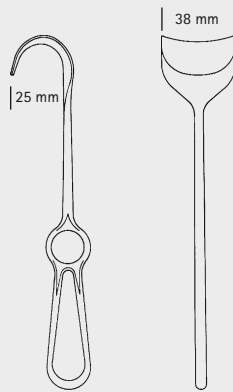

sharp
scharf

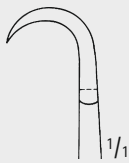

BT242R
9 x 8 mm



BT243R
9 x 13 mm



BT244R
9 x 19 mm



BT246R
9 x 29 mm

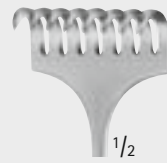

BT248R
9 x 40 mm

blunt
stumpf

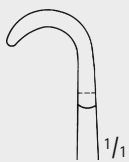

BT252R
8 x 8 mm



BT253R
8 x 13 mm



BT254R
8 x 19 mm



BT256R
8 x 29 mm

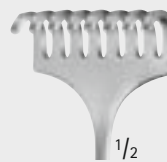

BT258R
8 x 40 mm

semi-sharp
halbscharf



BT257R
8.5 x 8 mm



BT259R
8.5 x 13 mm



BT260R
8.5 x 19 mm



BT261R
8.5 x 29 mm



BT265R
8.5 x 40 mm



VOLKMANN

BT242R-BT265R

220 mm, 8 3/4"

Retractors
Retraktoren

Retractors, Hooks – Retraktoren, Wundhaken

Retractors
Wundhaken

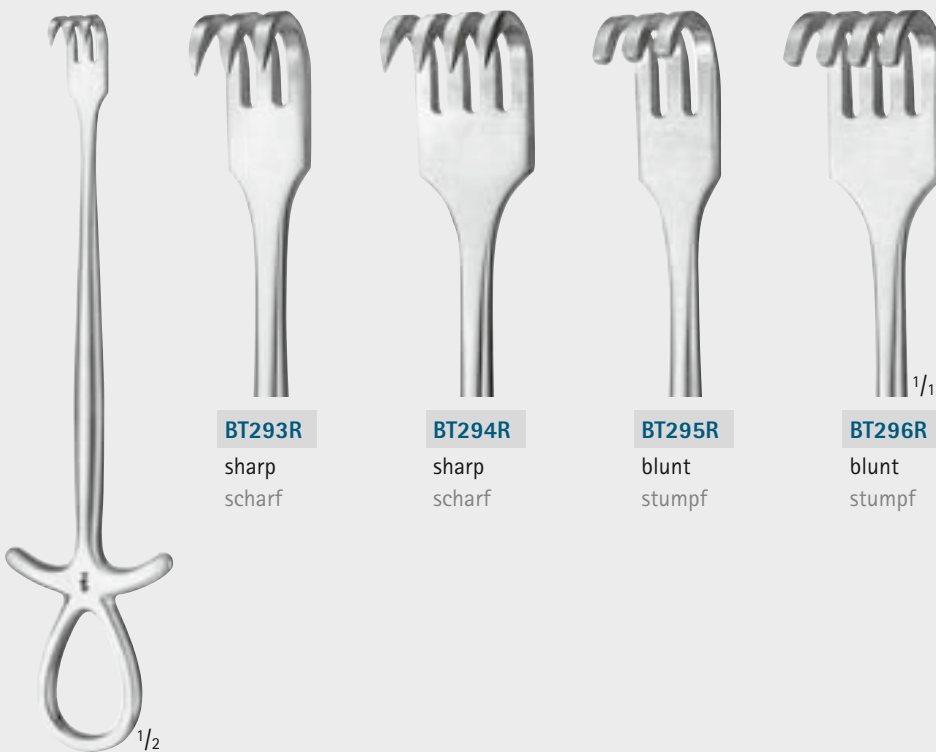

BT293R

sharp
scharf

BT294R

sharp
scharf

BT295R

blunt
stumpf

BT296R

blunt
stumpf

MURPHY

BT293R–BT296R

195 mm, 7 3/4"

Retractors
Retraktoren

MILLIMETERS

Retractors, Hooks – Retraktoren, Wundhaken

Retractors

Wundhaken

Dimensions for blade size of retractors

- 1st number = depth Example: 25 x 38 mm
- 2nd number = width

Maßangaben für Blattgrößen der Wundhaken

- 1. Zahl = Tiefe Beispiel: 25 x 38 mm
- 2. Zahl = Breite

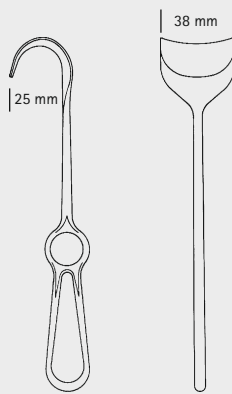

LANGENBECK
BT311R–BT316R
230 mm, 9"

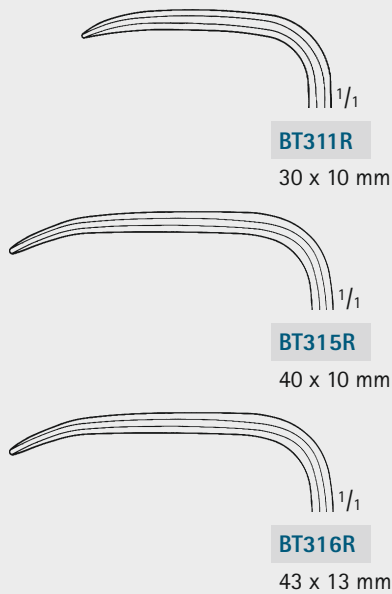

LANGENBECK
BT320R–BT326R
210 mm, 8 1/4"

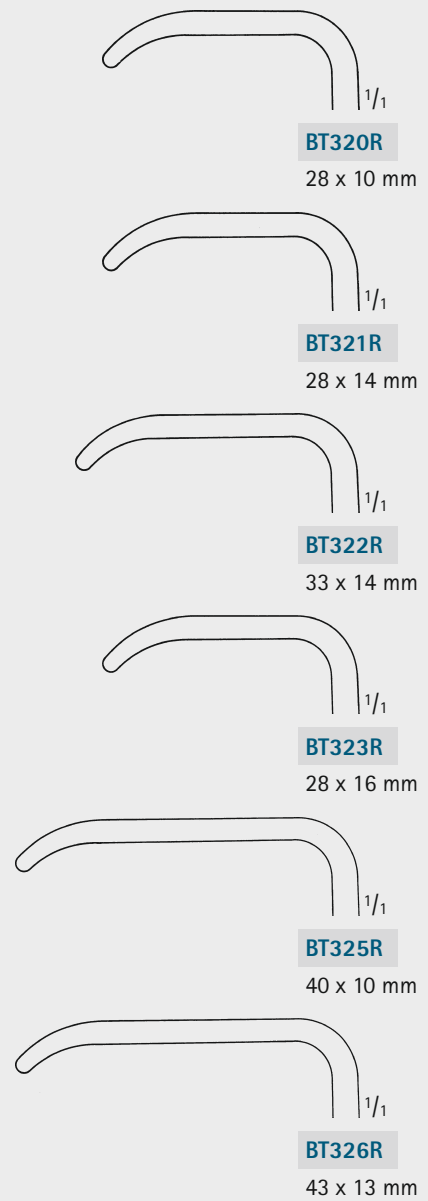

Retractors
Retraktoren

INCHES

Retractors, Hooks – Retraktoren, Wundhaken

Retractors
Wundhaken



KOCHER-LANGENBECK

BT354R–BT365R

215 mm, 8 1/2"

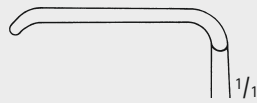

BT354R

25 x 6 mm

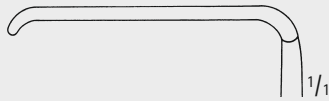

BT356R

35 x 8 mm

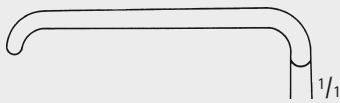

BT357R

35 x 11 mm

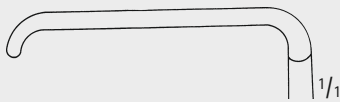

BT358R

35 x 15 mm

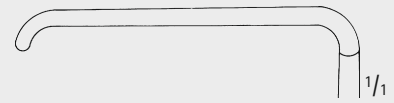

BT359R

41 x 11 mm

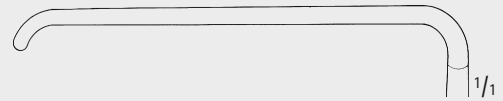

BT361R

55 x 11 mm

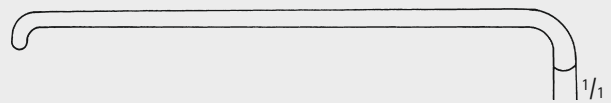

BT363R

70 x 14 mm

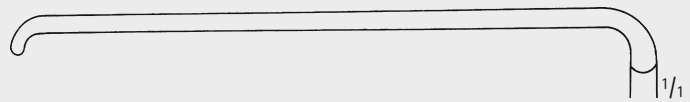

BT364R

80 x 12 mm

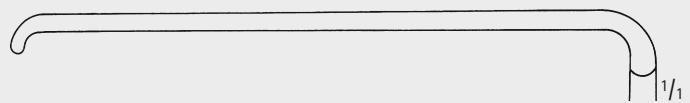

BT365R

80 x 16 mm

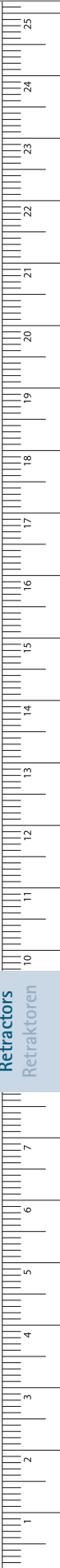

Retractors
Retraktoren

MILLIMETERS

Retractors, Hooks – Retraktoren, Wundhaken

Retractors

Wundhaken

Dimensions for blade size of retractors

- 1st number = depth Example: 25 x 38 mm
- 2nd number = width

Maßangaben für Blattgrößen der Wundhaken

- 1. Zahl = Tiefe Beispiel: 25 x 38 mm
- 2. Zahl = Breite

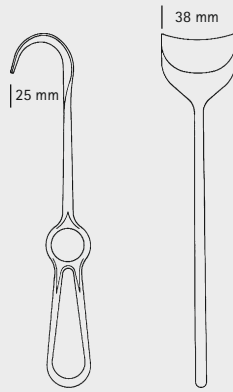

KOCHER

BT340R

210 mm, 8 1/4"

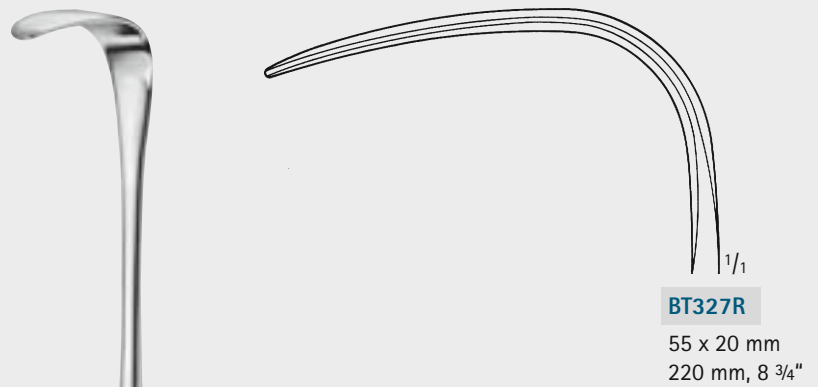

BT327R

55 x 20 mm
220 mm, 8 3/4"

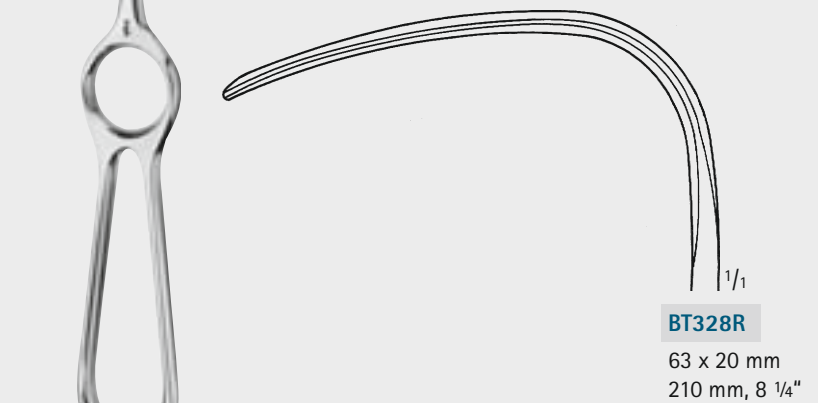

BT328R

63 x 20 mm
210 mm, 8 1/4"

LANGENBECK

BT327R-BT328R

Retractors
Retraktoren

INCHES

Retractors, Hooks – Retraktoren, Wundhaken

Retractors
Wundhaken



OBWEGESER

DO450R-DO455R

215 mm, 8 1/2"

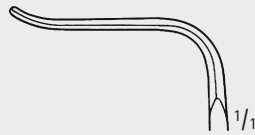

DO450R

25 x 7 mm

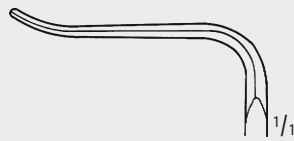

DO451R

31 x 10 mm

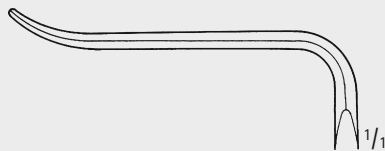

DO452R

42 x 11 mm



DO453R

55 x 12 mm

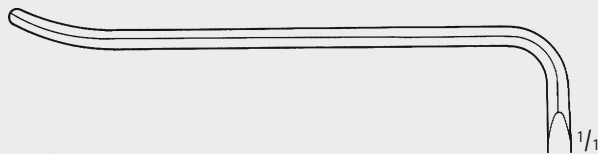

DO454R

70 x 14 mm

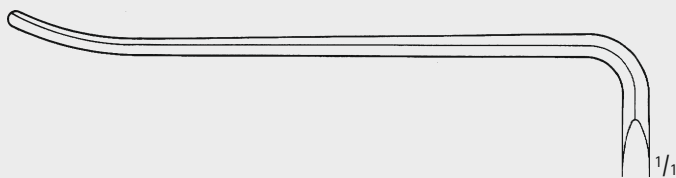

DO455R

80 x 16 mm

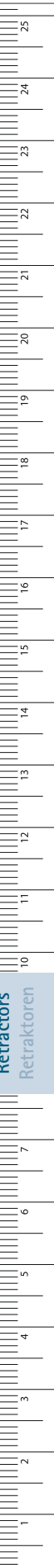

Retractors
Retraktoren

Retractors, Hooks – Retraktoren, Wundhaken

Retractors

Wundhaken

Dimensions for blade size of retractors

- 1st number = depth Example: 25 x 38 mm
- 2nd number = width

Maßangaben für Blattgrößen der Wundhaken

- 1. Zahl = Tiefe Beispiel: 25 x 38 mm
- 2. Zahl = Breite

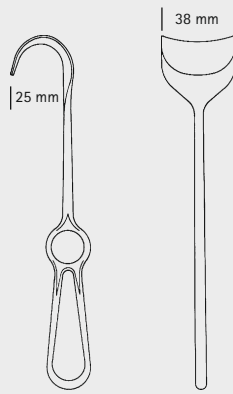

OBWEGESER
DO460R-DO465R

215 mm, 8 1/2"



DO460R

25 x 7 mm

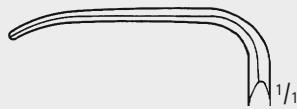

DO461R

31 x 10 mm

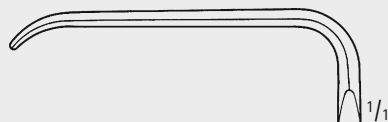

DO462R

42 x 11 mm

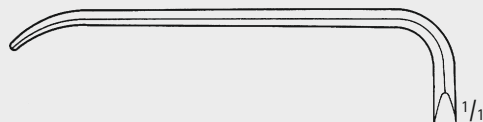

DO463R

55 x 12 mm

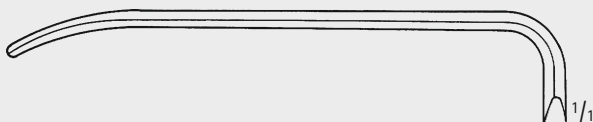

DO464R

70 x 14 mm

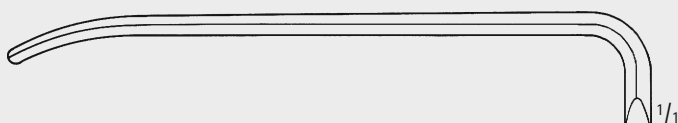

DO465R

80 x 16 mm

Retractors
Retraktoren

Retractors, Hooks – Retraktoren, Wundhaken

Retractors Wundhaken

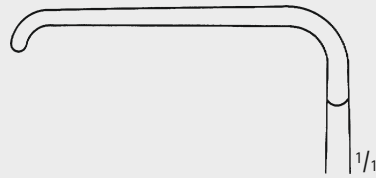

BT369R

40 x 18 mm

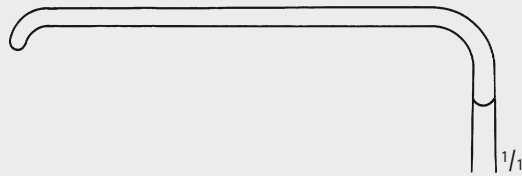

BT370R

60 x 20 mm

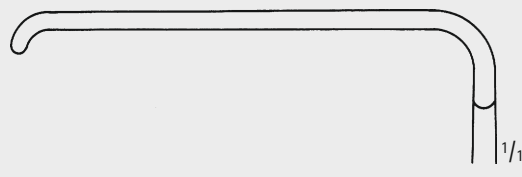

BT371R

60 x 25 mm

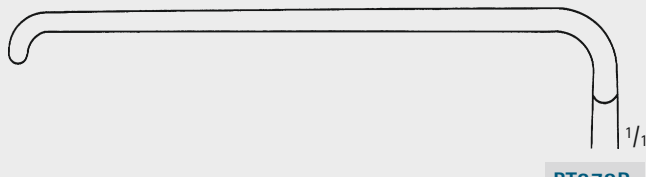

BT372R

75 x 30 mm

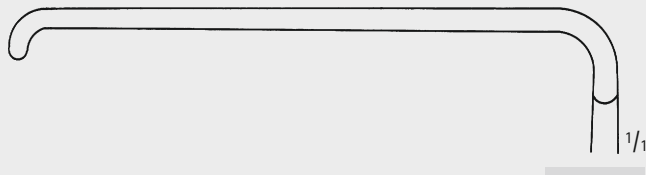

BT373R

75 x 40 mm



KOCHER

BT369R–BT373R

230 mm, 9"

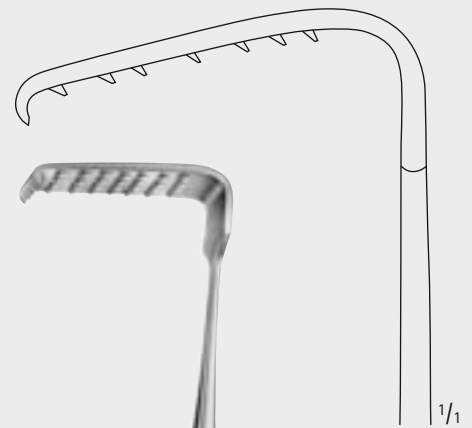

BRÜNINGS-BRUNK

OK800R

Antrum retractor
Kieferhöhlenhaken
190 mm, 7 1/2"

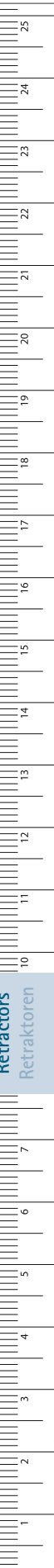

Retractors, Hooks – Retraktoren, Wundhaken

Retractors

Wundhaken

Dimensions for blade size of retractors

- 1st number = depth Example: 25 x 38 mm
- 2nd number = width

Maßangaben für Blattgrößen der Wundhaken

- 1. Zahl = Tiefe Beispiel: 25 x 38 mm
- 2. Zahl = Breite

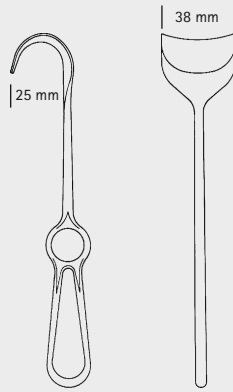

SAUERBRUCH
BT351R–BT353R

225 mm, 8 7/8"

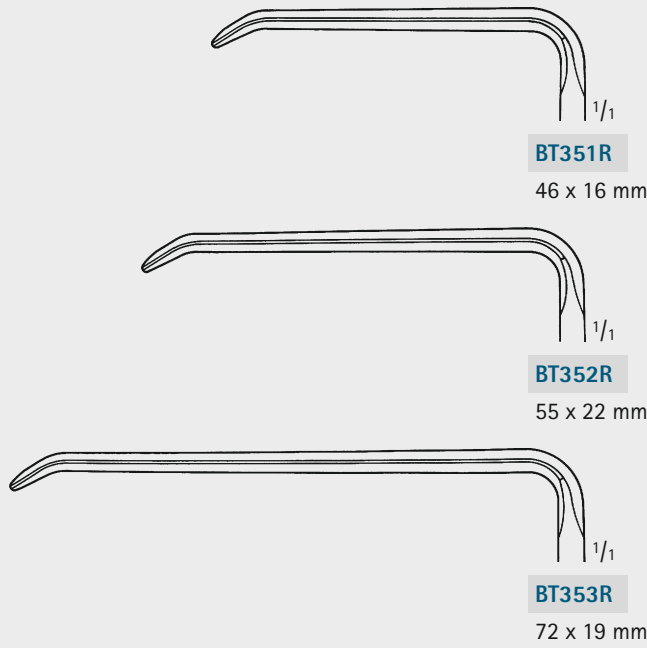

BT351R
46 x 16 mm

BT352R
55 x 22 mm

BT353R
72 x 19 mm



LAHEY
MB785R

200 mm, 7 7/8"

Retractors
Retraktoren

INCHES

Retractors, Hooks – Retraktoren, Wundhaken

Retractors
Wundhaken

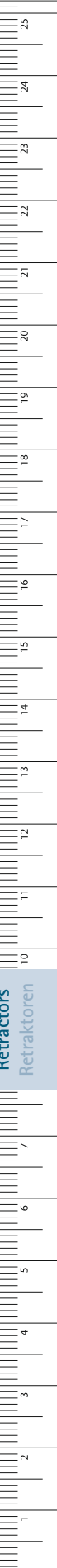
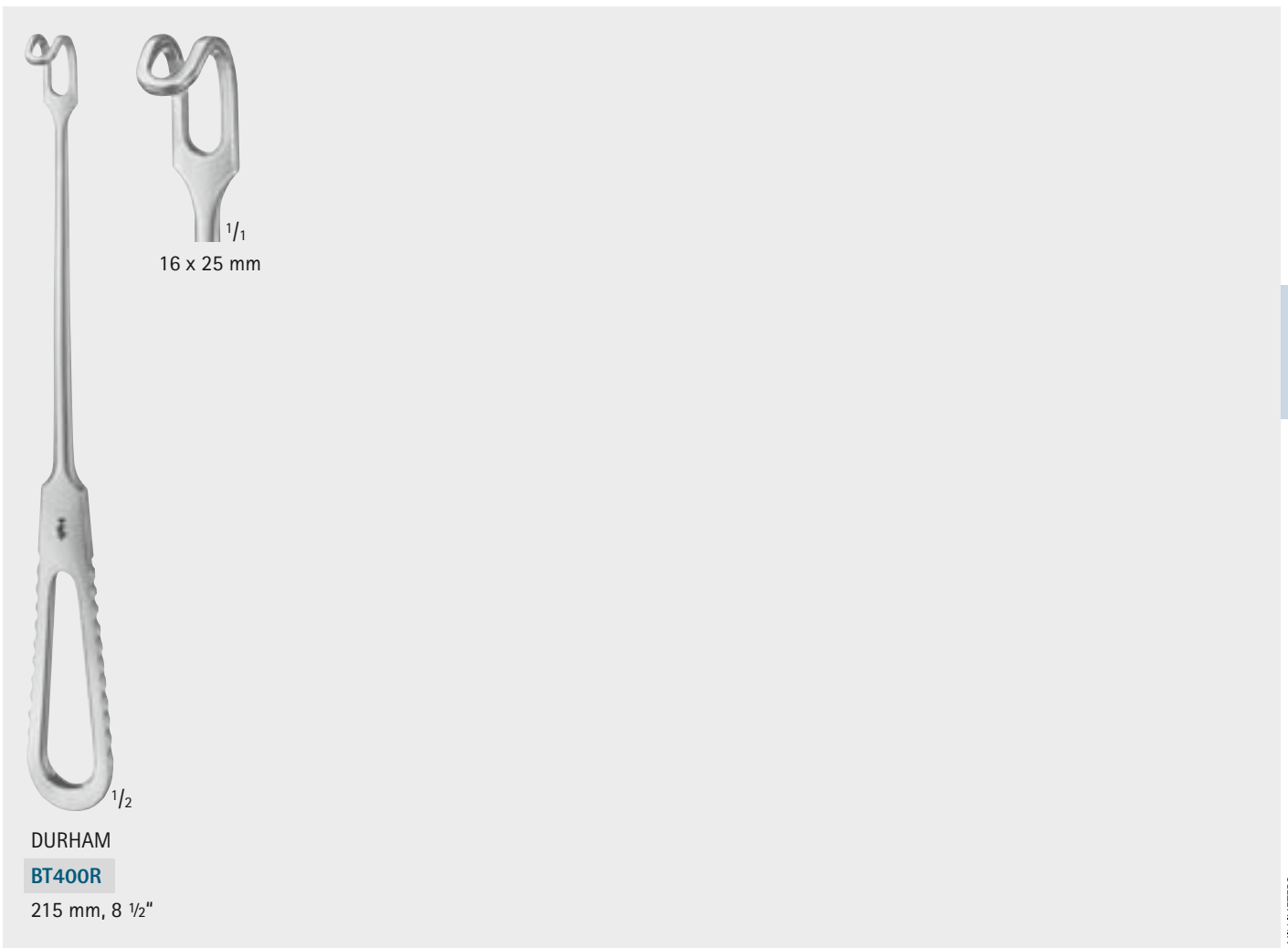
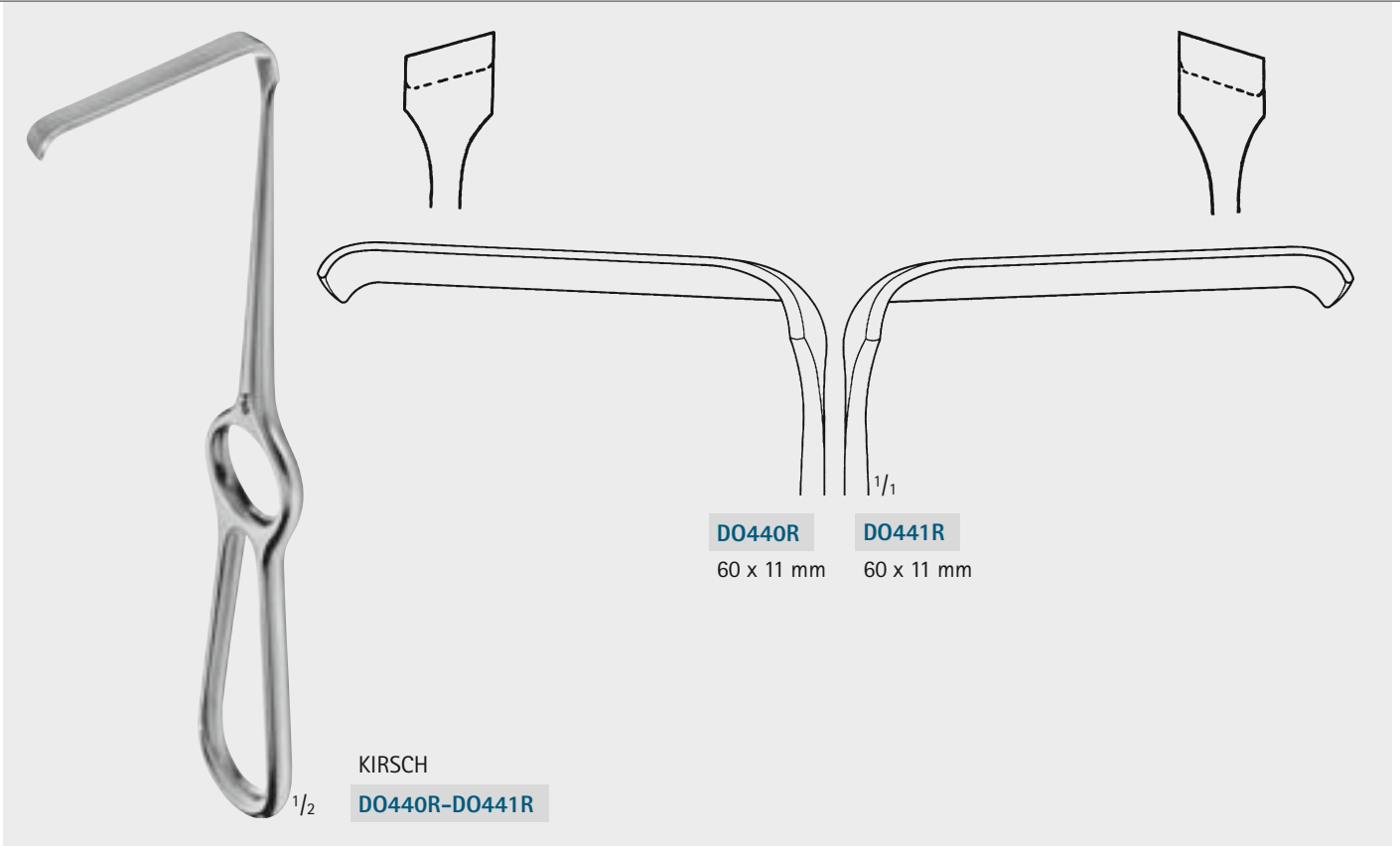

Retractors
Retraktoren

Retractors, Hooks – Retraktoren, Wundhaken

Retractors

Wundhaken

Dimensions for blade size of retractors

- 1st number = depth Example: 25 x 38 mm
- 2nd number = width

Maßangaben für Blattgrößen der Wundhaken

- 1. Zahl = Tiefe Beispiel: 25 x 38 mm
- 2. Zahl = Breite

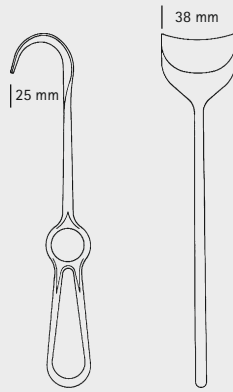

BT404R

15 x 15 mm
220 mm, 8 3/4"



MIDDENDORPF

BT404R-BT406R



BT405R

20 x 22 mm
215 mm, 8 1/2"

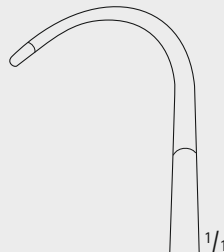

BT406R

28 x 28 mm
235 mm, 9 1/4"

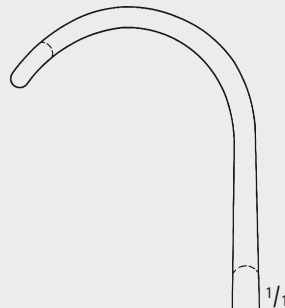

GREENE

BT408R

225 mm, 8 7/8"



28 x 22 mm

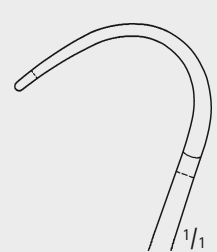

Retractors
Retraktoren

INCHES

Retractors, Hooks – Retraktoren, Wundhaken

Retractors
Wundhaken



BÜCHS
DO432R
205 mm, 8"

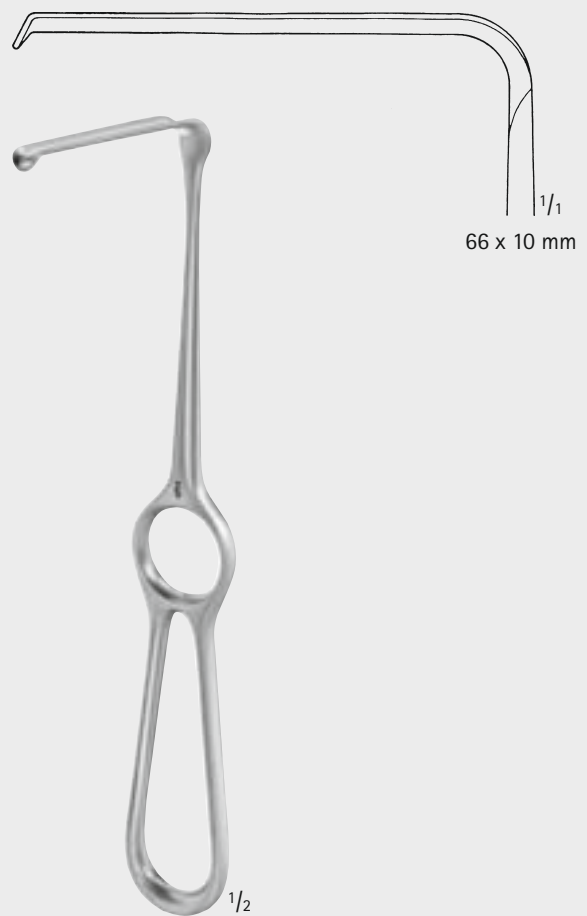

KRÄMER
BT464R
210 mm, 8 1/4"

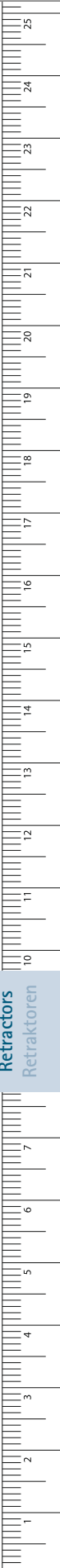

Retractors
Retraktoren

Retractors, Hooks – Retraktoren, Wundhaken

Retractors

Wundhaken



Dimensions for blade size of retractors

- 1st number = depth Example: 25 x 38 mm
- 2nd number = width

Maßangaben für Blattgrößen der Wundhaken

- 1. Zahl = Tiefe Beispiel: 25 x 38 mm
- 2. Zahl = Breite

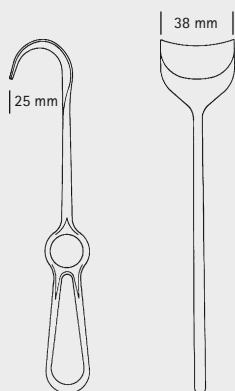

CASPAR
BT465R
 210 mm, 8 1/4"

DOCKHORN
DO438R-DO439R
 210 mm, 8 1/4"

Retractors, Hooks – Retraktoren, Wundhaken

Retractors Wundhaken



KOCHER

BT459R

230 mm, 9"



ZENKER

BT594R

240 mm, 9 1/2"

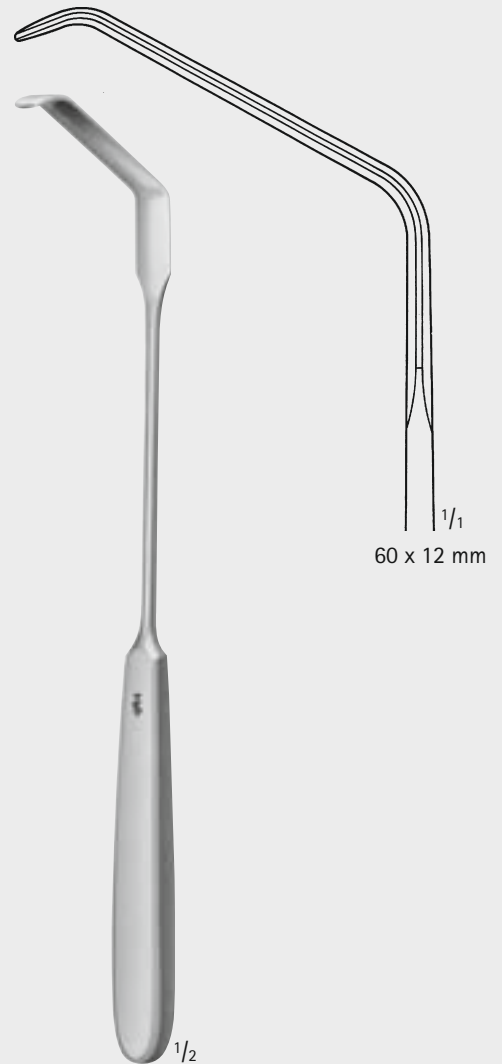

ZENKER

BT595R

255 mm, 10"

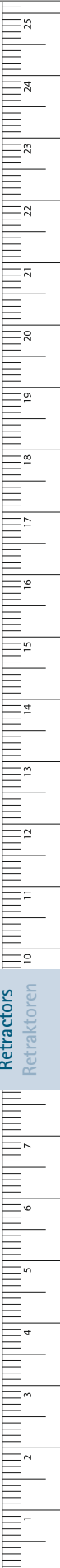

Retractors, Hooks – Retraktoren, Wundhaken



Retractors
Retraktoren

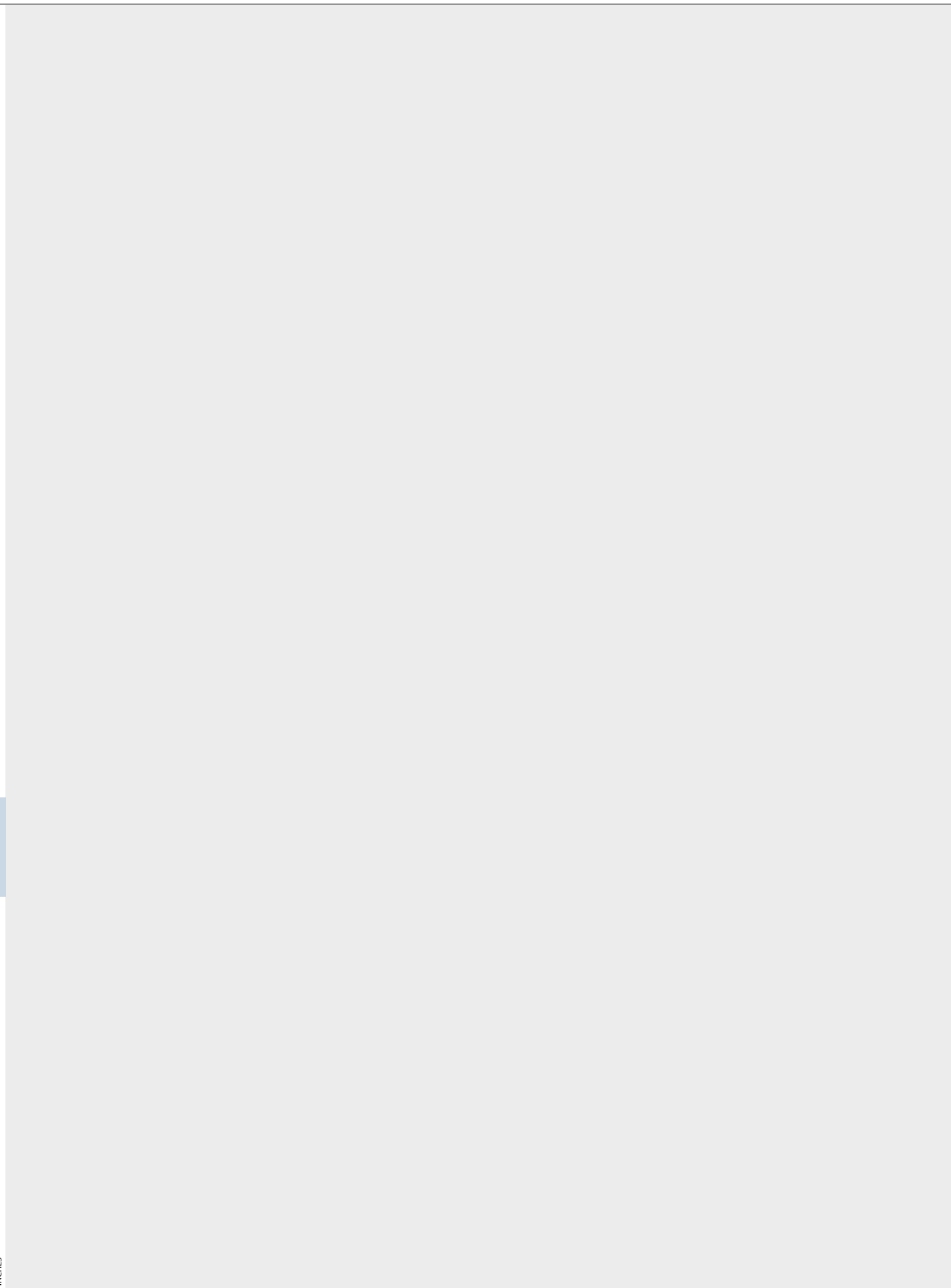

General Surgical Instruments
Chirurgische Instrumente



General Surgical Instruments - Chirurgische Instrumente

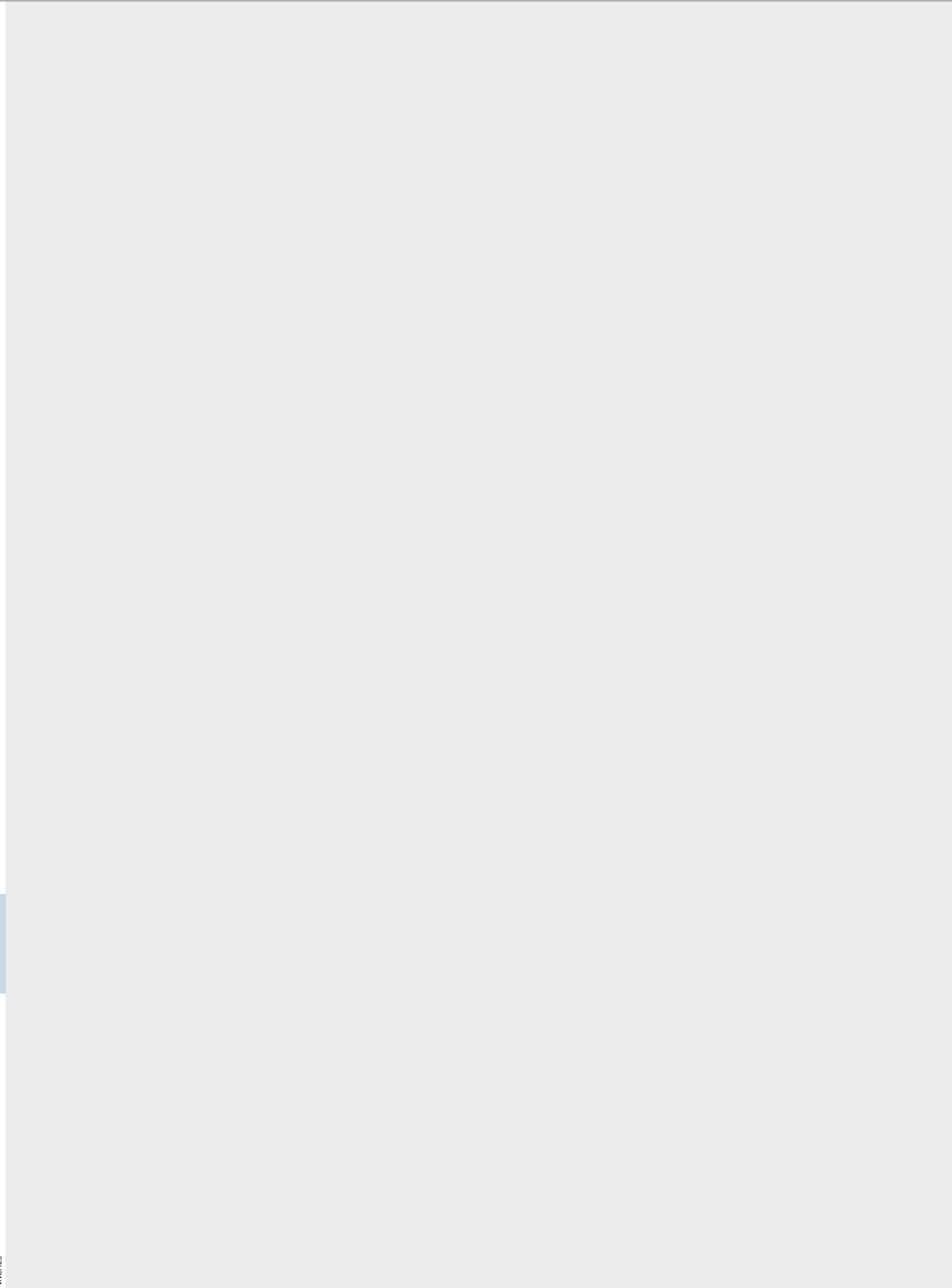

General Surgical Instruments Chirurgische Instrumente

- Preparation
- Vorbereitung

Patient Preparation – Patienten-Vorbereitung

Sponge- and Dressing Forceps

Korn- und Tupferzangen

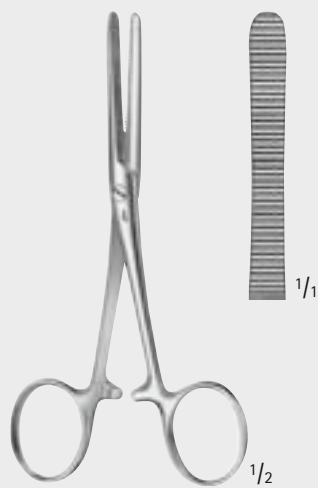

PEAN
BH410R
125 mm, 5"



KRÖNLEIN
BH300R
130 mm, 5 1/8"



BH302R 125 mm 5"
BH304R 140 mm 5 1/2"

PEAN
BH302R-BH304R

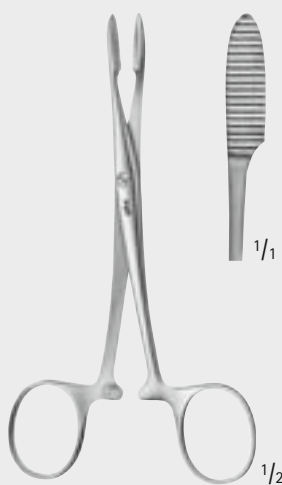

PEAN
BH312R
125 mm, 5"



BH316R 165 mm 6 1/2"
BH318R 185 mm 7 1/4"

PEAN
BH316R-BH318R

Patient Preparation – Patienten-Vorbereitung

Sponge- and Dressing Forceps

Korn- und Tupferzangen

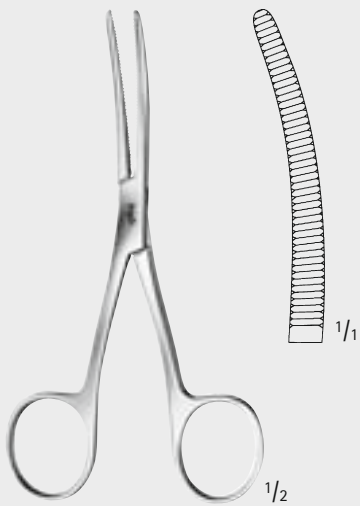

BRYANT
BF003R
130 mm, 5 1/8"

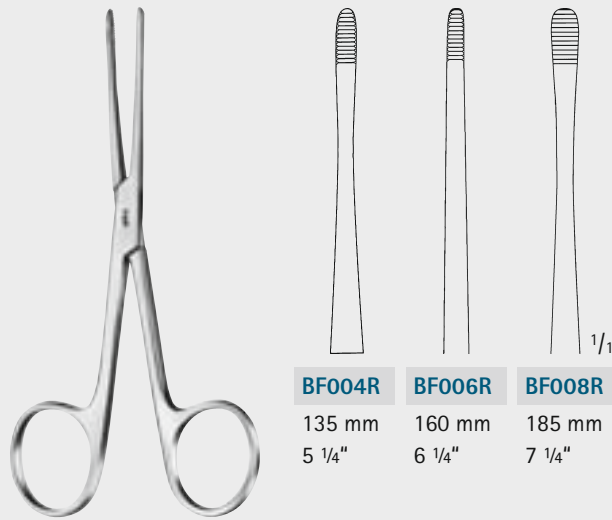

LISTER
BF004R–BF008R
Sinus forceps
Sinusklemmen

BF004R	BF006R	BF008R
135 mm	160 mm	185 mm
5 1/4"	6 1/4"	7 1/4"

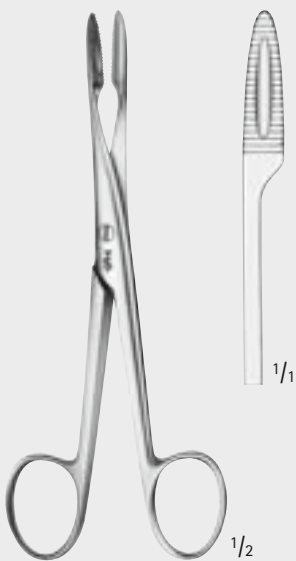

BF010R
without ratchet
ohne Sperre
145 mm, 5 3/4"



BF016R
with ratchet
mit Sperre
145 mm, 5 3/4"

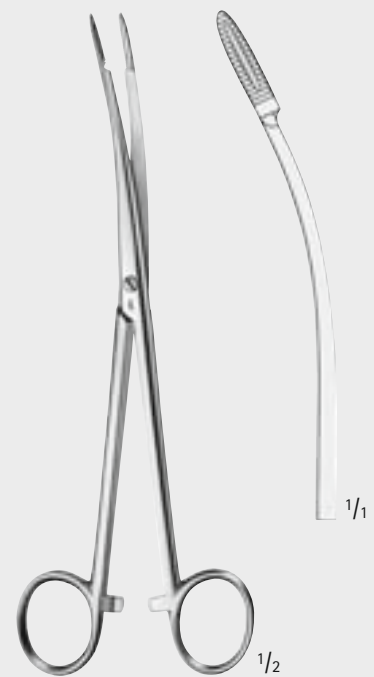

BF021R
175 mm, 6 7/8"

Patient Preparation – Patienten-Vorbereitung

Sponge- and Dressing Forceps

Korn- und Tupferzangen

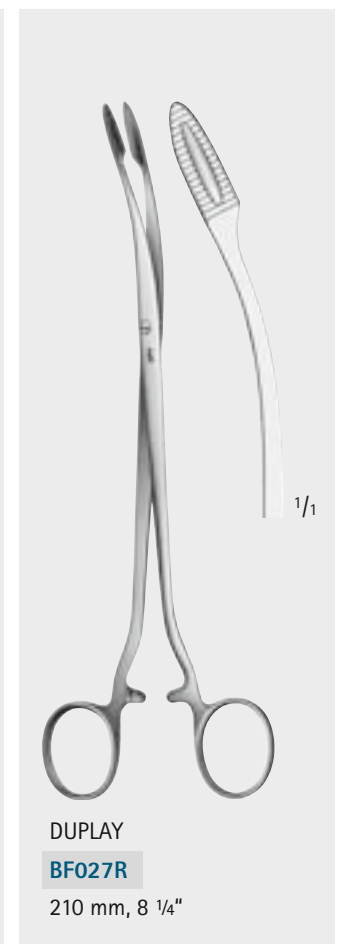
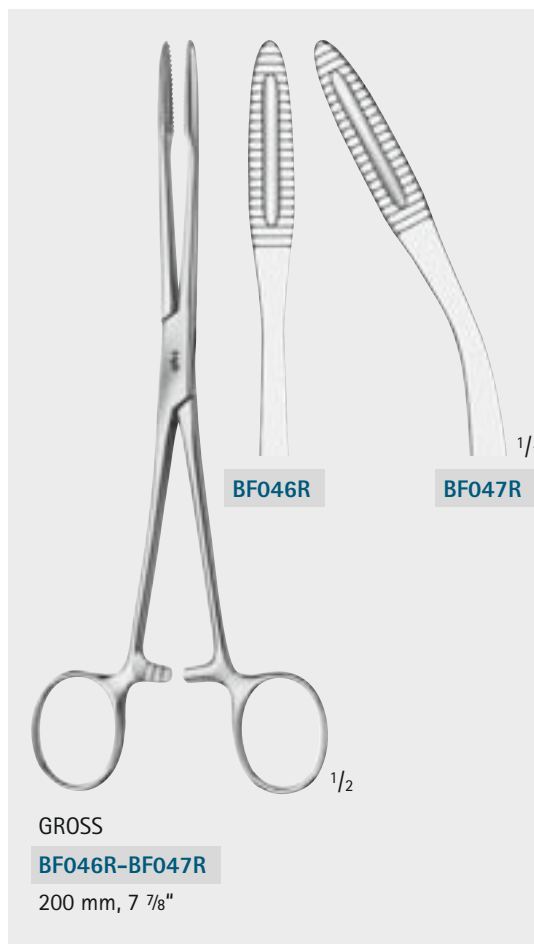
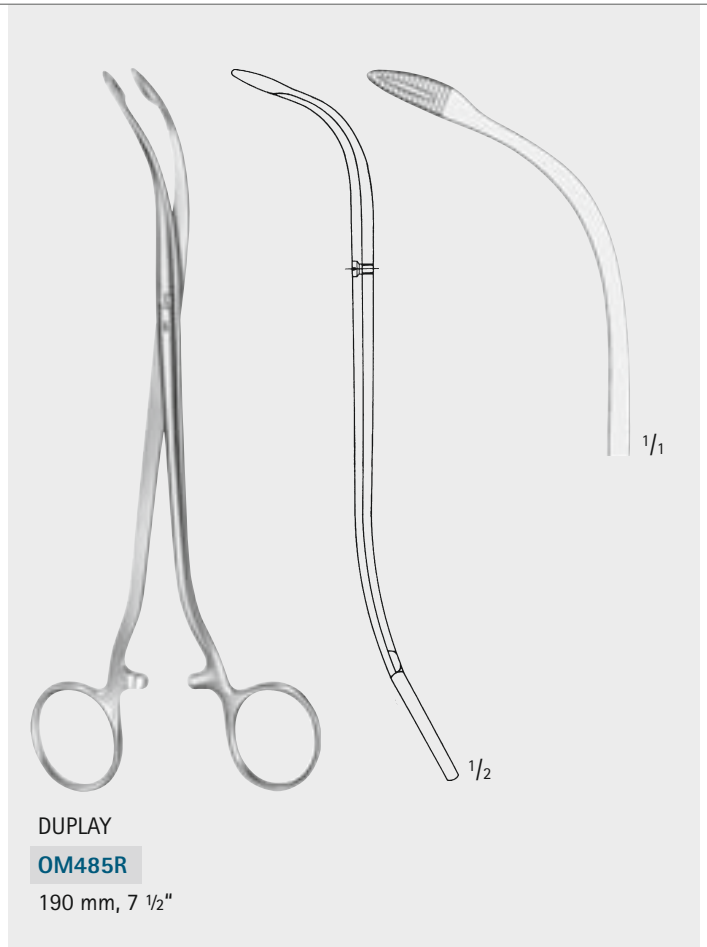
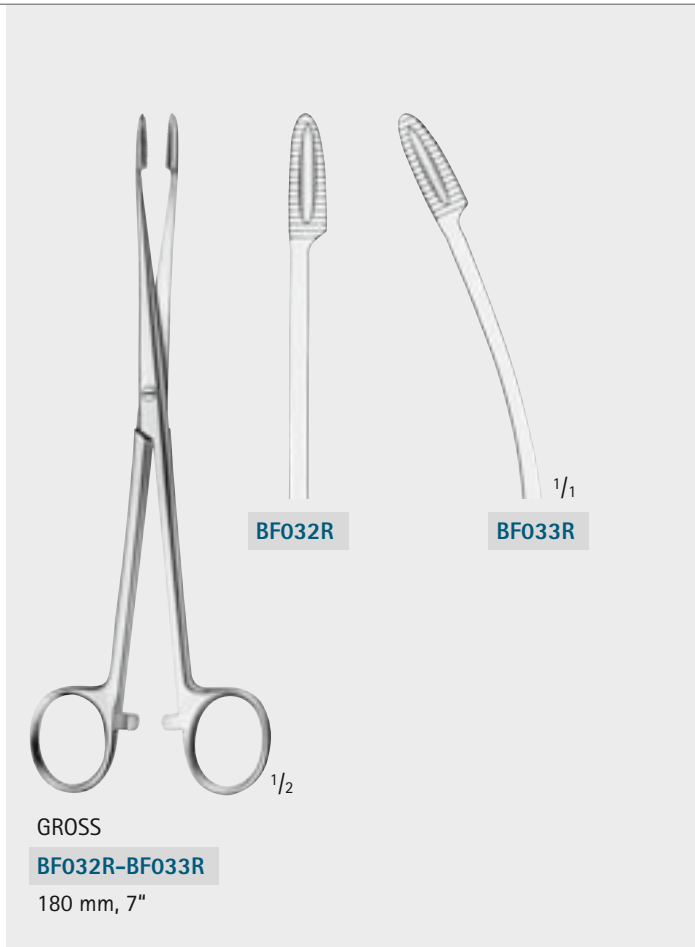

Preparation
Vorbereitung

Patient Preparation – Patienten-Vorbereitung

Sponge- and Dressing Forceps Korn-, Tupfer- und Waschzangen

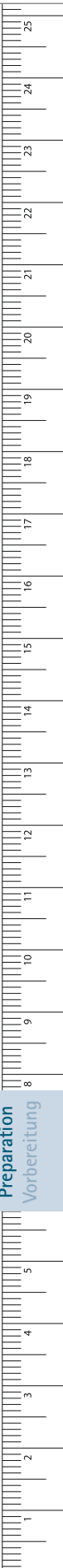
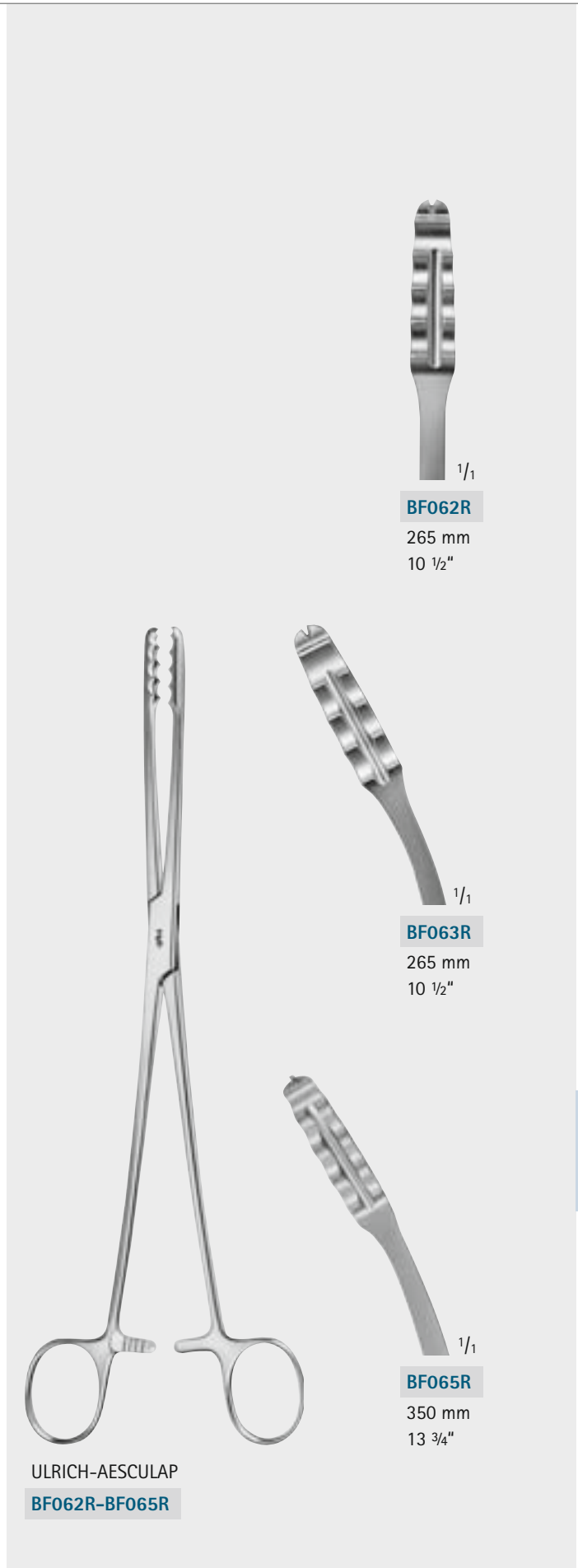
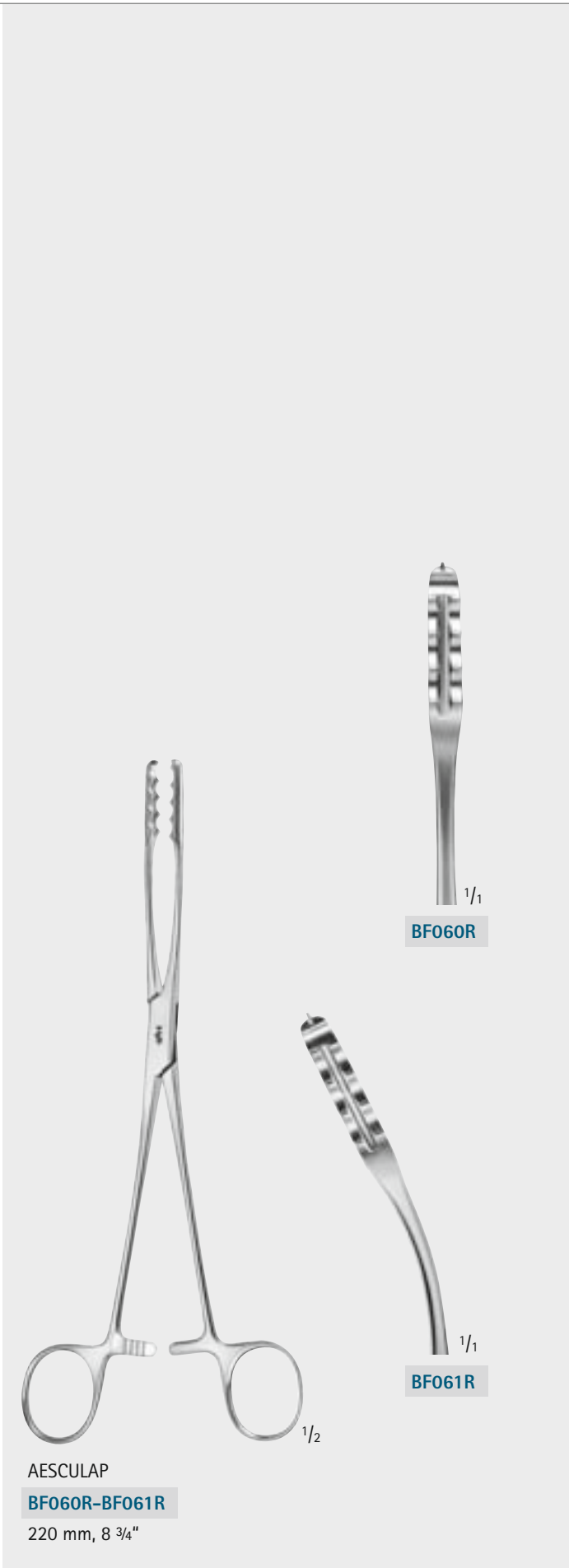

Patient Preparation – Patienten-Vorbereitung

Sponge- and Dressing Forceps

Korn-, Tupfer- und Waschzangen



Preparation
Vorbereitung

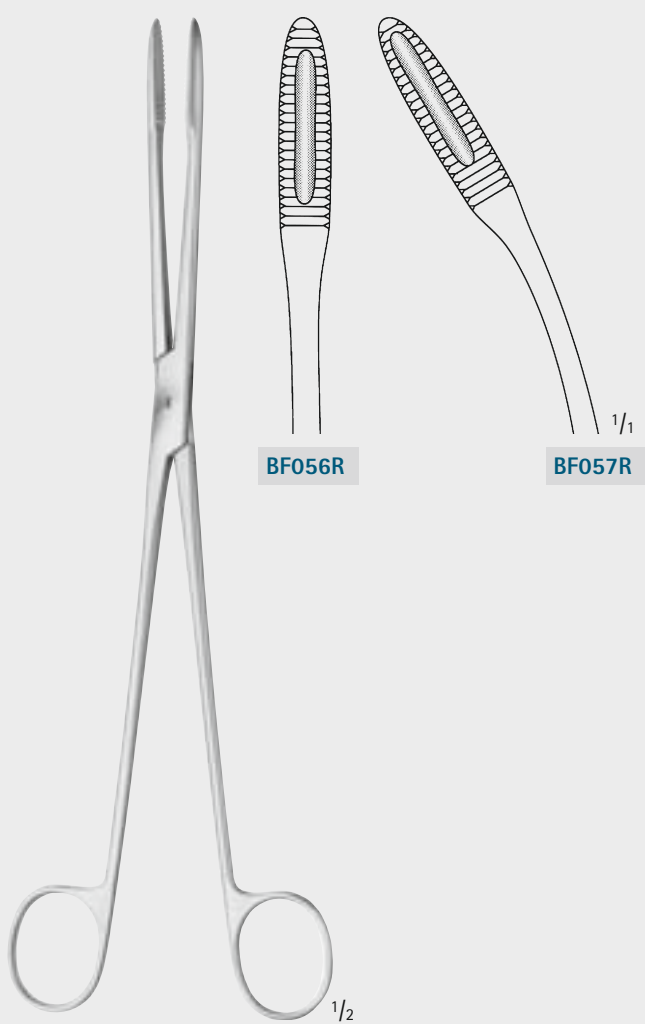

MAIER
BF056R-BF057R
without ratchet
ohne Sperre
265 mm, 10 1/2"

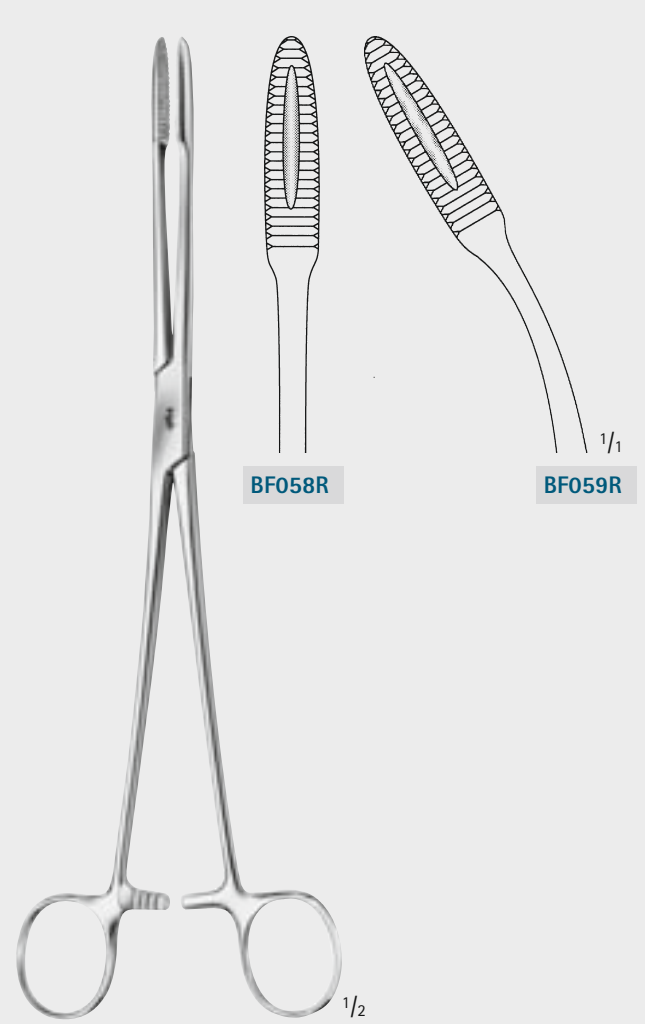

MAIER
BF058R-BF059R
with ratchet
mit Sperre
260 mm, 10 1/4"

Patient Preparation – Patienten-Vorbereitung

Sponge- and Dressing Forceps
Korn-, Tupfer- und Waschzangen



BF076R

280 mm, 11"

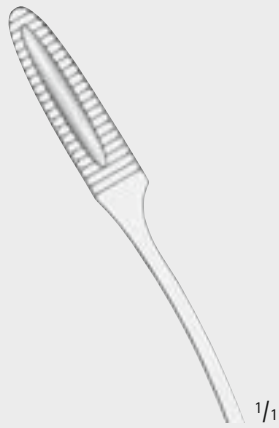

BF077R

280 mm, 11"



BF078R

350 mm, 13 3/4"



SIMS-MAIER

BF076R-BF078R



BF070R-BF071R

240 mm, 9 1/2"



BF070R



BF071R

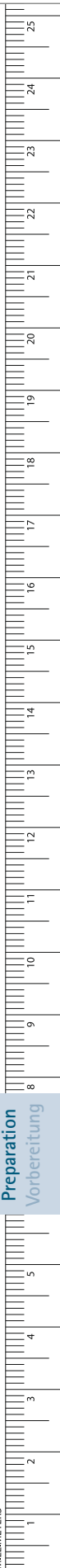

Preparation
Vorbereitung

Patient Preparation – Patienten-Vorbereitung

Dressing- and Sponge Holding Forceps

Tupfer- und Schwammzangen



BF112R
BF113R ^{1/1}

FOERSTER-BALLENGER
BF112R-BF113R
180 mm, 7" ^{1/2}

BF116R
BF118R ^{1/1}

RAMPLEY
BF116R-BF118R
180 mm, 7" 250 mm, 9 3/4"

BF120R
BF121R ^{1/1}

smooth jaws
glattes Maul

BF122R
BF123R ^{1/1}

FOERSTER-BALLENGER
BF120R-BF123R
245 mm, 9 5/8"

Preparation
Vorbereitung

Patient Preparation – Patienten-Vorbereitung

Tubing Clamps

Schlauchklemmen

- heavy pattern, long ratchet, therefore passage adjustable
- starkes Modell, lange Sperre, daher Durchlauf dosierbar

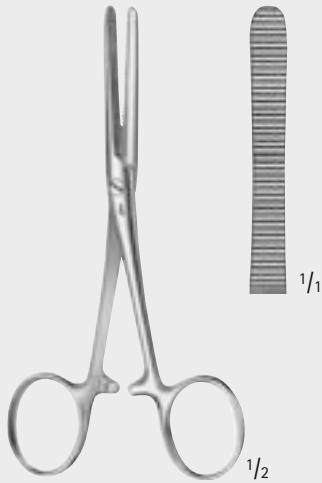

PEAN

BH410R

125 mm, 5"



KLINIKUM BERLIN

AN908R

145 mm, 5 3/4"



AN909R

especially heavy pattern

sehr starkes Modell

165 mm, 6 1/2"



1/1

smooth jaw
glattes Maul



AN910R

especially heavy pattern

sehr starkes Modell

165 mm, 6 1/2"



1/1

serrated jaw
geriefes Maul

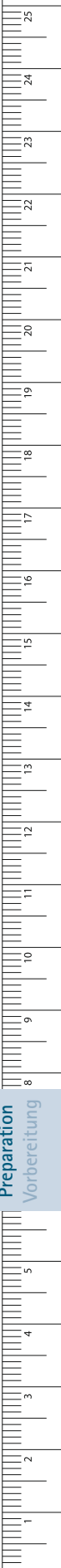

Preparation
Vorbereitung

MILLIMETERS

Patient Preparation – Patienten-Vorbereitung

Tubing Clamps

Schlauchklemmen



AN912R
180 mm, 7"

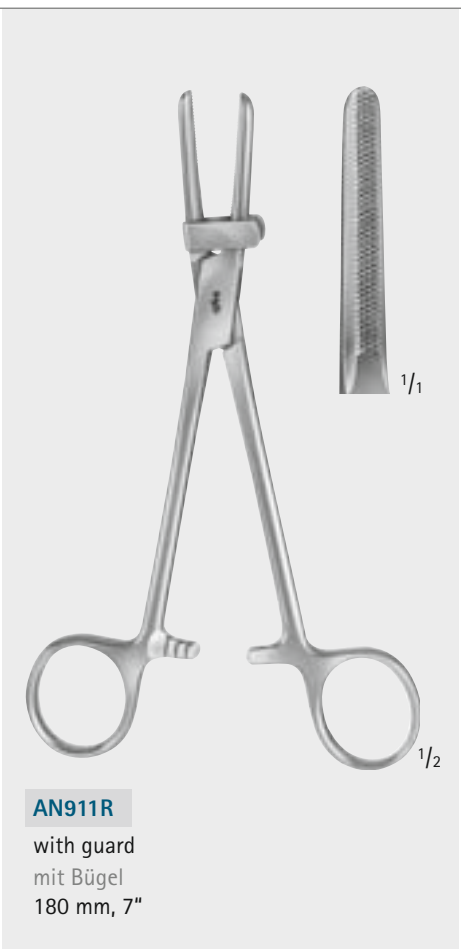

AN911R
with guard
mit Bügel
180 mm, 7"

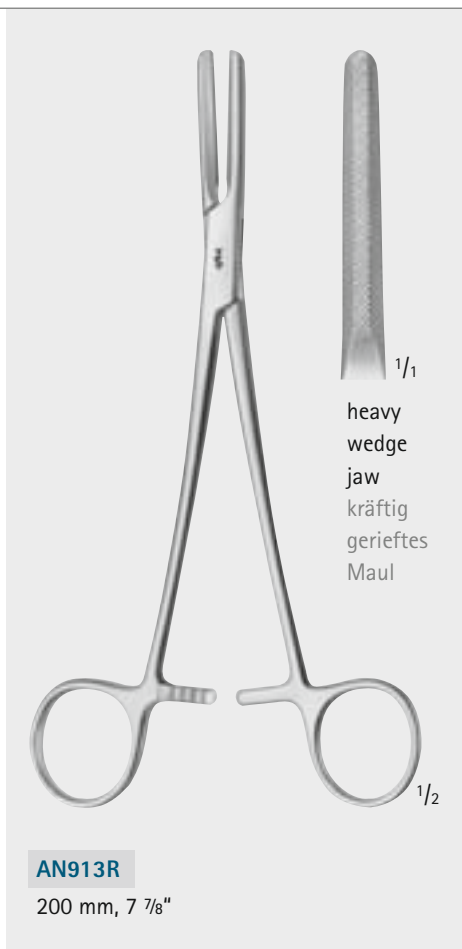

AN913R
200 mm, 7 7/8"

heavy
wedge
jaw
kräftig
gerieftes
Maul

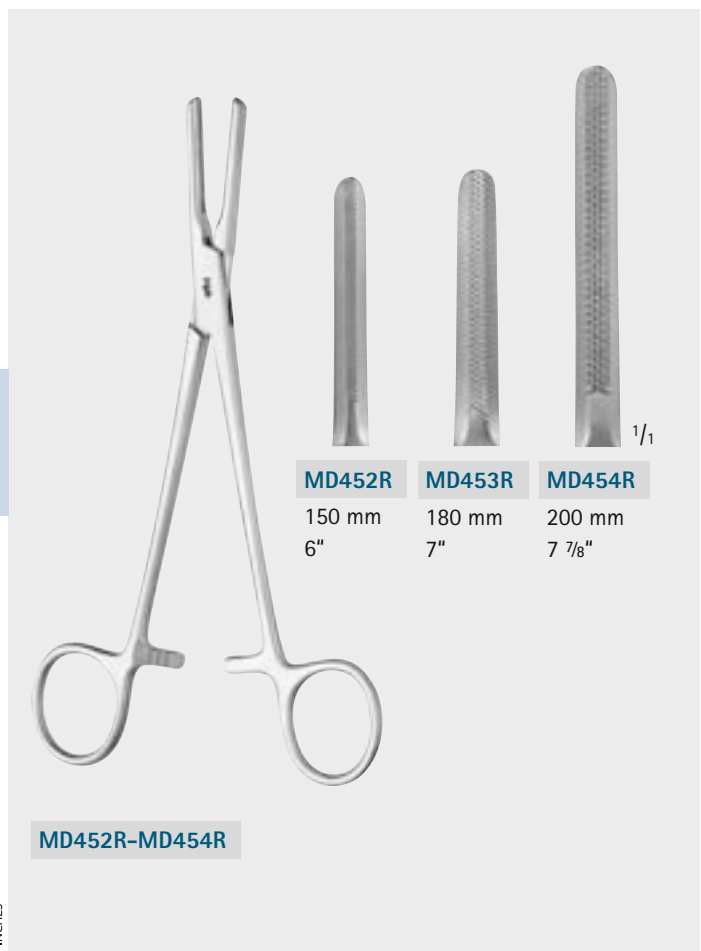

MD452R	MD453R	MD454R
150 mm 6"	180 mm 7"	200 mm 7 7/8"

MD452R-MD454R

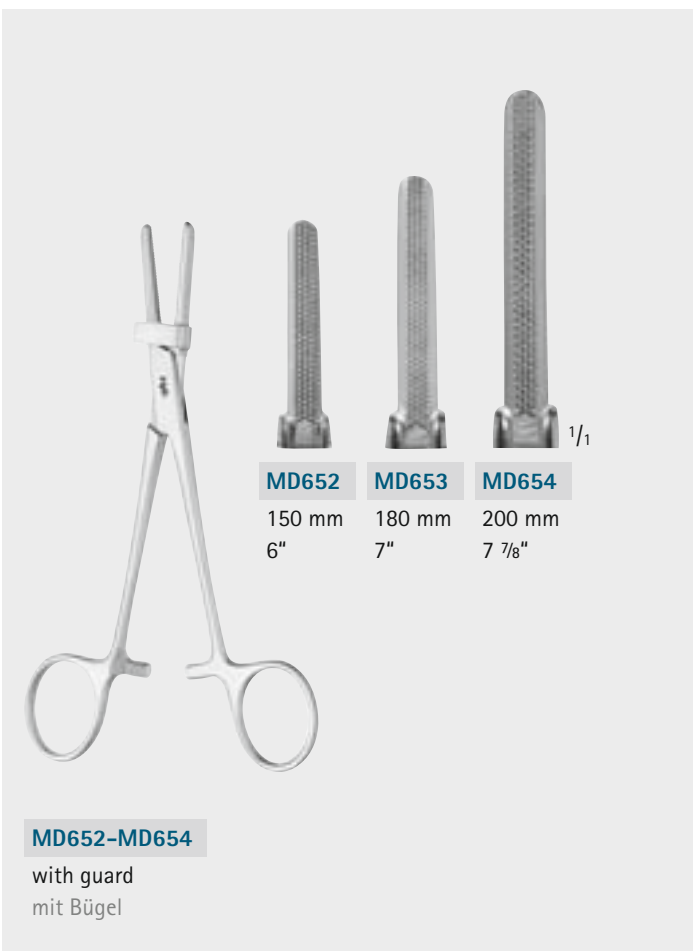

MD652	MD653	MD654
150 mm 6"	180 mm 7"	200 mm 7 7/8"

MD652-MD654
with guard
mit Bügel

Patient Preparation – Patienten-Vorbereitung

Towel Clamps

Tuchklemmen

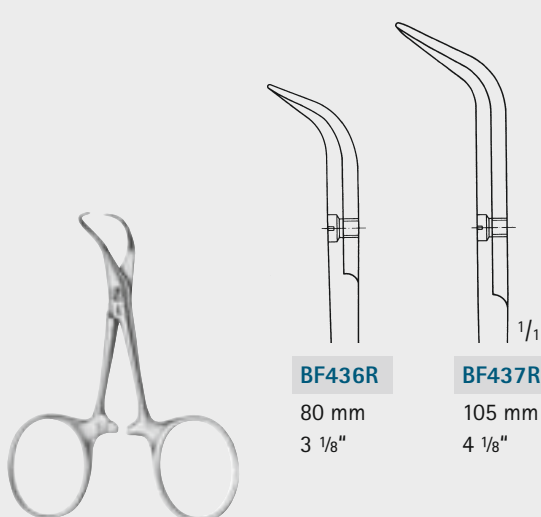

Two Backhaus towel clamps are shown. The first is BF436R, with a length of 80 mm (3 1/8"). The second is BF437R, with a length of 105 mm (4 1/8"). Both have curved tips and a locking mechanism. A 1/1 magnification diagram is provided for each.

BACKHAUS
BF436R-BF437R

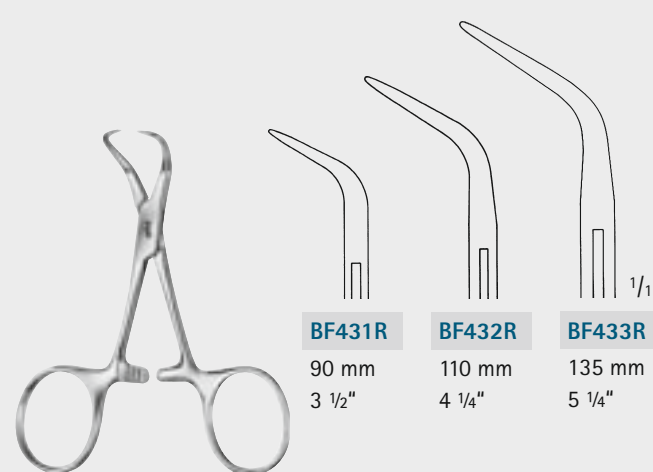

Three Backhaus towel clamps are shown. The first is BF431R, with a length of 90 mm (3 1/2"). The second is BF432R, with a length of 110 mm (4 1/4"). The third is BF433R, with a length of 135 mm (5 1/4"). All have curved tips and a locking mechanism. A 1/1 magnification diagram is provided for each.

BACKHAUS
BF431R-BF433R

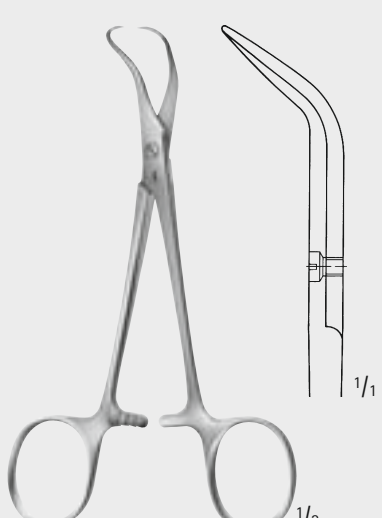

A Backhaus-Kocher towel clamp is shown, model BF444R, with a length of 135 mm (5 1/4"). It features a curved tip and a locking mechanism. A 1/2 magnification diagram is provided.

BACKHAUS-KOCHER
BF444R
135 mm, 5 1/4"

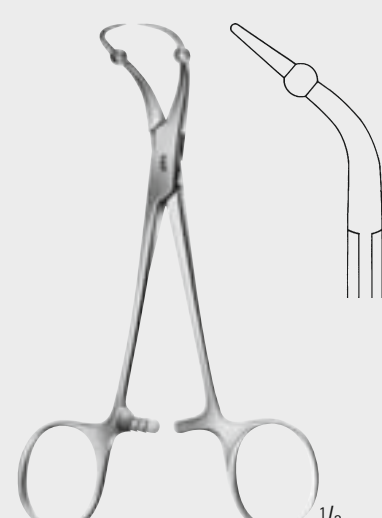

A Roeder towel clamp is shown, model BF448R, with a length of 135 mm (5 1/4"). It has a curved tip and a locking mechanism. A 1/2 magnification diagram is provided.

ROEDER
BF448R
135 mm, 5 1/4"

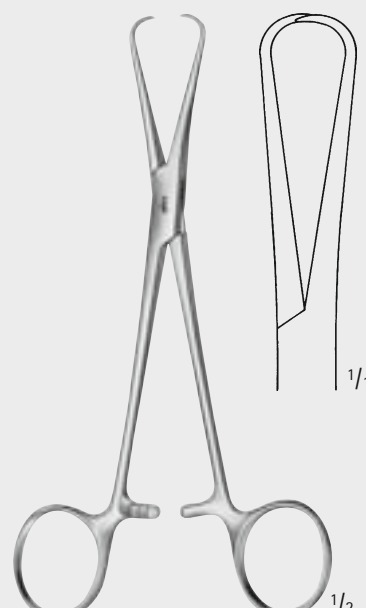

A Bernhard towel clamp is shown, model BF426R, with a length of 160 mm (6 1/4"). It has a curved tip and a locking mechanism. A 1/2 magnification diagram is provided.

BERNHARD
BF426R
160 mm, 6 1/4"

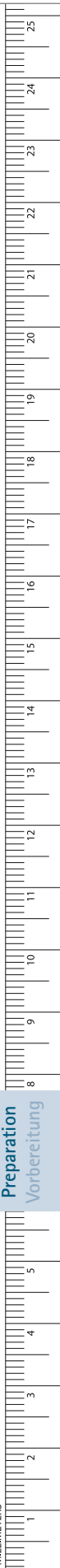

Patient Preparation – Patienten-Vorbereitung

Towel Clamps

Tuchklemmen



ROBIN
BF439R
with holders
for cable up to 5 mm
mit Kabelhalterung
bis 5 mm Kabelstärke
135 mm, 5 1/4"

ROBIN
BF440R
with holders
for tubing up to 13 mm
mit Schlauchhalterung
bis 13 mm Schlauchstärke
135 mm, 5 1/4"

ROBIN
BF442R
with holders for tubing up to 15 mm
mit Schlauchhalterung bis
15 mm Schlauchstärke
110 mm, 4 1/4"

ROBIN
BF443R
Tube fixation forceps with
atraumatic jaw parts
Doppelschlauch-Fixierklemme
atraumatische Fassfläche
140 mm, 5 1/2"

Preparation
Vorbereitung

Patient Preparation – Patienten-Vorbereitung

Towel Clamps

Tuchklemmen

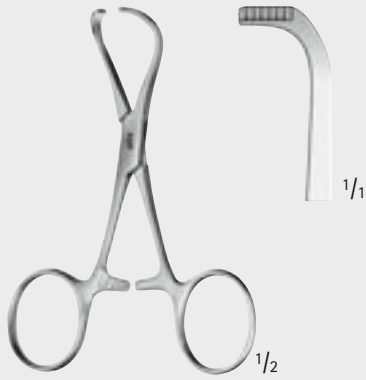

LORNA

BF461R

non-perforating
nicht perforierend
95 mm, 3 3/4"

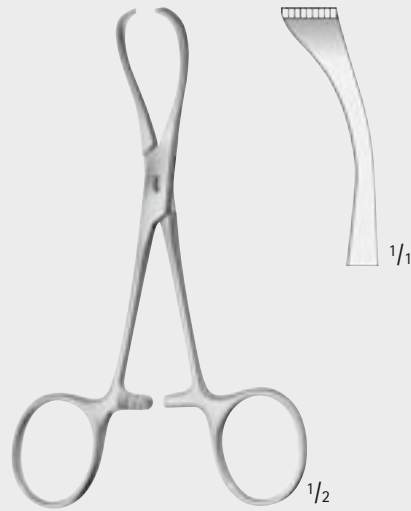

LORNA

BF463R

non-perforating
nicht perforierend
130 mm, 5 1/8"

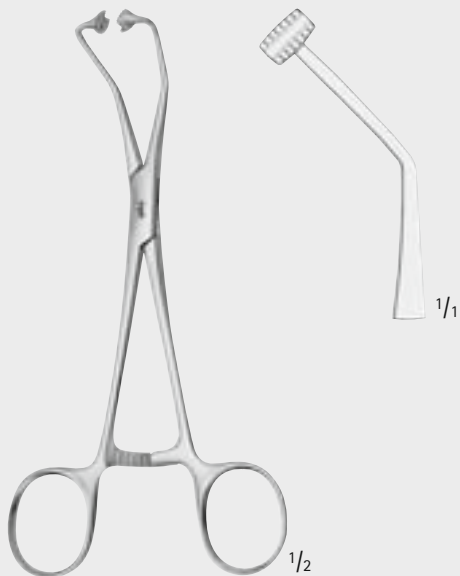

BF460R

for paper drapes
für Papiertücher
150 mm, 6"



BF464R

for paper drapes
für Papiertücher
140 mm, 5 1/2"

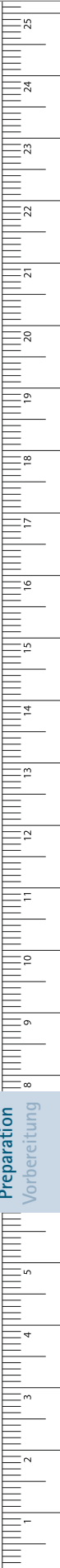

Preparation
Vorbereitung

Patient Preparation – Patienten-Vorbereitung

Towel Clamps

Tuchklemmen

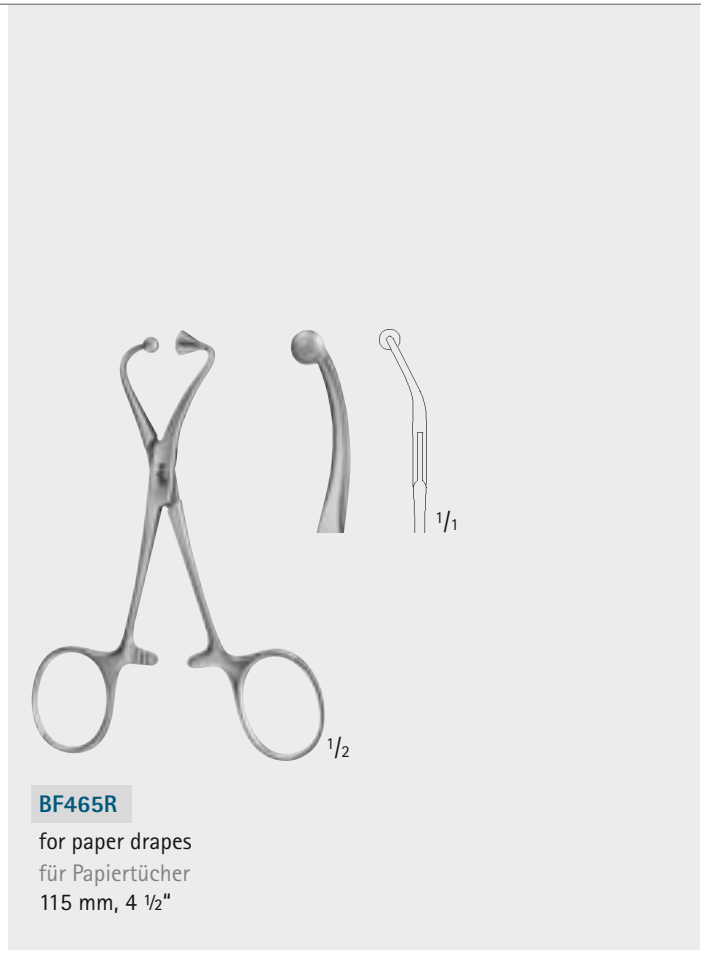

BF465R

for paper drapes
für Papiertücher
115 mm, 4 1/2"

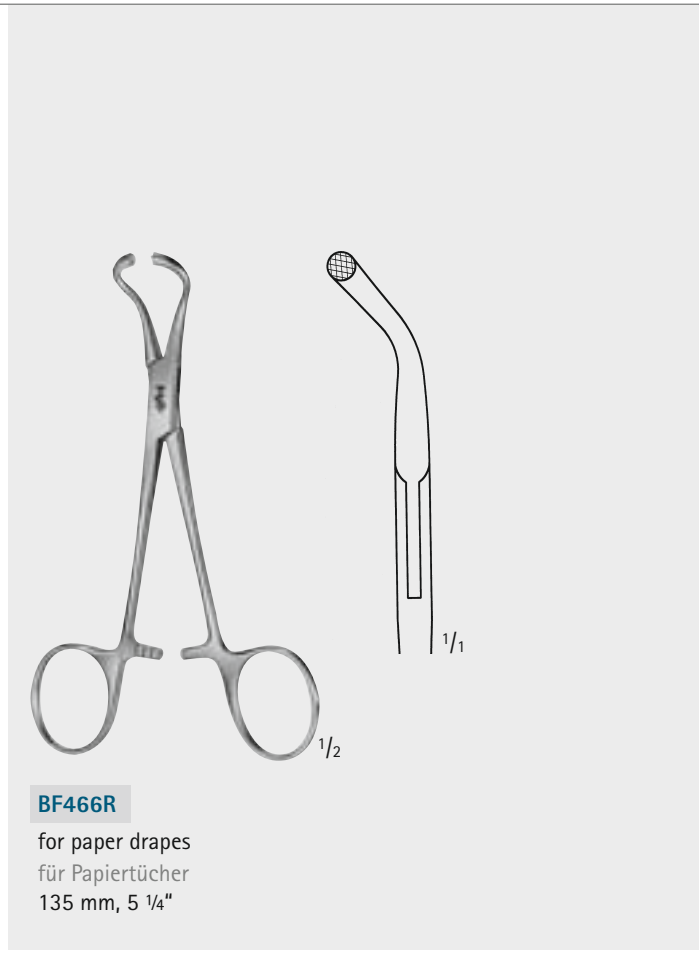

BF466R

for paper drapes
für Papiertücher
135 mm, 5 1/4"

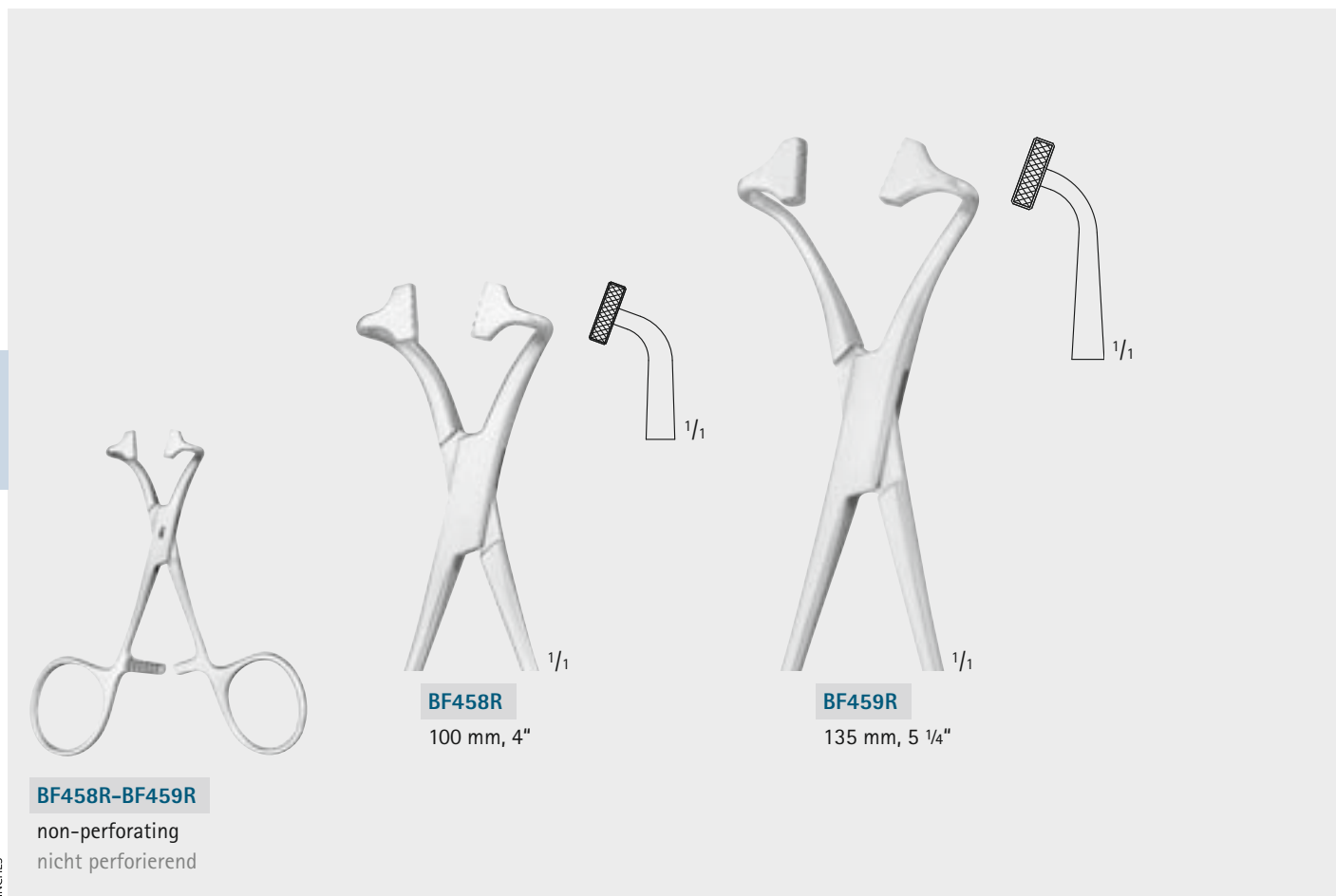

BF458R

100 mm, 4"

BF459R

135 mm, 5 1/4"

BF458R-BF459R

non-perforating
nicht perforierend

Preparation
Vorbereitung

Patient Preparation – Patienten-Vorbereitung

Catheter Introducing Forceps

Kathetereinführungszangen

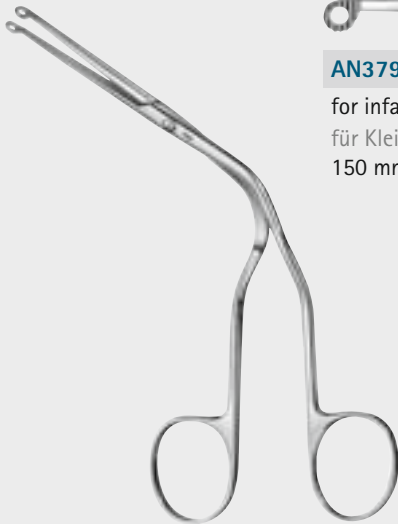

MAGILL

AN379R-AN381R



AN379R

for infants
für Kleinkinder
150 mm, 6"

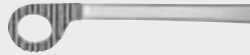

AN380R

for children
für Kinder
200 mm, 7 7/8"



AN381R

for adults
für Erwachsene
250 mm, 9 3/4"

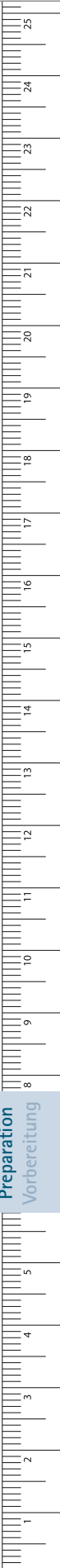

Preparation
Vorbereitung

Patient Preparation – Patienten-Vorbereitung

Steel Ruler, Calipers

Stahlmaßstab, Messzirkel, Messschieber



Art. No. Art. Nr.	Length Länge
AA804R	150 mm, 6"
AA805R	300 mm, 11 3/4"
AA806R	500 mm, 19 3/4"

Steel ruler, stainless, graduated in millimeters and inches
Stahlmaßstab, nichtrostend, Millimeter- und Zolleinteilung



CASTROVIEJO

OB792R
Caliper, measuring range 0-15 mm
Messzirkel, Messbereich 0-15 mm
75 mm, 3"



OB793R

Caliper, measuring range 0-40 mm
Messzirkel, Messbereich 0-40 mm
170 mm, 6 3/4"



AA845R

Special caliper, measuring range up to 150 mm
Spezial-Messschieber, Messbereich bis 150 mm



AA846R

Caliper, measuring range up to 150 mm
Messschieber, Messbereich bis 150 mm
230 mm, 9"



AA847R

Caliper, measuring range up to 100 mm
Messschieber, Messbereich bis 100 mm
130 mm, 5 1/8"

Preparation
Vorbereitung

INCHES

General Surgical Instruments Chirurgische Instrumente

- Scalpels
- Skalpelle

Scalpels – Skalpelle

Safety Scalpels

Sicherheitskalpelle

Single Use

sterile

steril

BA810SU-BA836SU

Sales unit:

PAK = Package of 10 pieces

Bestelleinheit:

PAK = Packung à 10 Stück



BA810SU

Fig. 10



BA811SU

Fig. 11



BA812SU

Fig. 12



BA813SU

Fig. 13



BA815SU

Fig. 15



BA815-1SU

Fig. 15-1



BA815-CSU

Fig. 15-C



BA818SU

Fig. 18

Scalpels
Skalpelle



Scalpels – Skalpelle

Safety Scalpels

Sicherheitskalpelle

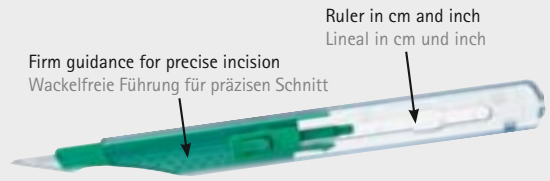
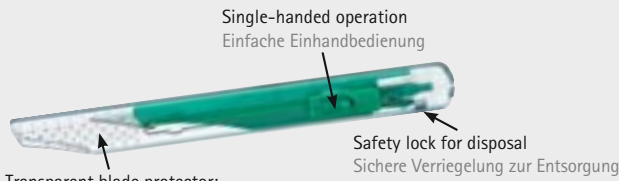

Transparent blade protector:

- Blade shape is visible
- Position of blade is always evident

Transparenter Klingenschutz:

- Klingenfigur ist sichtbar
- Position der Klinge jederzeit erkennbar



1/1

BA819SU

Fig. 19



1/1

BA820SU

Fig. 20



1/1

BA821SU

Fig. 21



1/1

BA822SU

Fig. 22



1/1

BA823SU

Fig. 23



1/1

BA824SU

Fig. 24



1/1

BA825SU

Fig. 25



1/1

BA836SU

Fig. 36

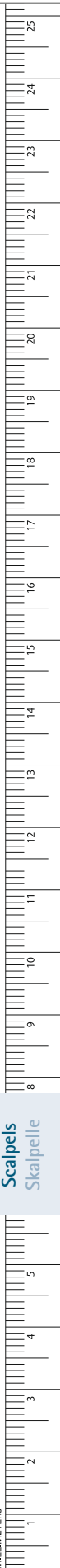

Scalpels
Skalpelle

MILLIMETERS

Scalpels - Skalpelle

Single Use Scalpels

Einmalskalpelle

sterile
steril

BA210-BA224 / 5518016-5518105

Sales unit:

PAK = Package of 10 pieces

Bestelleinheit:

PAK = Packung à 10 Stück



1/1

Carbon Steel **BA210**

Stainless Steel **5518059**

Fig. 10



1/1

BA211

5518040

Fig. 11



1/1

BA212

5518105

Fig. 12



1/1

BA215

5518032

Fig. 15



1/1

BA215-1

Fig. 15-1



1/1

BA215-C

Fig. 15-C



1/1

BA218

Fig. 18

Scalpels
Skalpelle

INCHES

Scalpels – Skalpelle

Single Use Scalpels

Einmalskalpelle

sterile
steril



1/1

Carbon Steel **BA219**
Stainless Steel

Fig. 19



1/1

BA220
5518067

Fig. 20



1/1

BA221
5518075

Fig. 21



1/1

BA222
5518083

Fig. 22



1/1

BA223
5518016

Fig. 23



1/1

BA224
5518091

Fig. 24

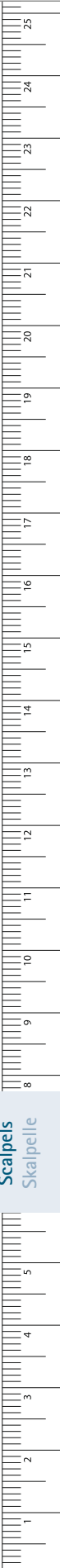

Scalpels - Skalpelle

Single Use Scalpels

Einmalskalpelle



sterile / steril

BA311SU-BA323SU

Sales unit:

PAK = Package of 10 pieces

Bestelleinheit:

PAK = Packung à 10 Stück

sterile / steril

BA364-BA367

Sales unit:

PAK = Package of 5 pieces

Bestelleinheit:

PAK = Packung à 5 Stück



BA311SU

Fig. 11
230 mm, 9"



BA323SU

Fig. 23
230 mm, 9"



BA364

165 mm, 6 1/2"



BA365

165 mm, 6 1/2"



BA367

165 mm, 6 1/2"

Scalpels
Skalpelle

Scalpels – Skalpelle

Scalpel Handles

Skalpellgriffe

For blades fig. 10 - 15 and fig. 40, 42 / Für Klingen Fig. 10 - 15 und Fig. 40, 42



BARRON

BBO68R

130 mm, 5 1/8"



BB073R

No. 3
125 mm, 5"



BB074R

No. 3
with cm / inch scale
cm / inch graduiert
125 mm, 5"



BB075R

No. 3 L
210 mm, 8 1/4"

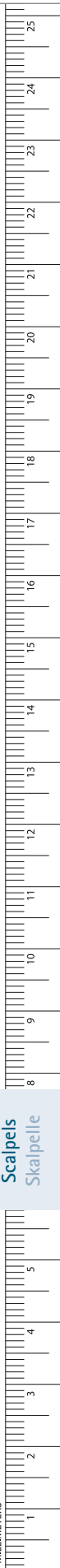

Scalpels - Skalpelle

Scalpel Handles

Skalpellgriffe

For blades fig. 10 - 15 and fig. 40, 42 / Für Klingen Fig. 10 - 15 und Fig. 40, 42

corresponds with english No. 5
entspricht der englischen Nr. 5



BB077R
No. 7
160 mm, 6 1/4"



BB078R
225 mm, 8 7/8"

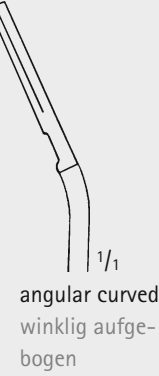

BB079R
225 mm, 8 7/8"



BB071R
210 mm, 8 1/4"



BB070R
155 mm, 6 1/8"



BB063R
145 mm, 5 3/4"

Scalpels
Skalpelle

INCHES

Scalpels – Skalpelle

Scalpel Handles

Skalpellgriffe

For blades fig. 18 - 36 / Für Klingen Fig. 18 - 36



BB084R

No. 4
135 mm, 5 1/4"



BB085R

No. 4 L
215 mm, 8 1/2"

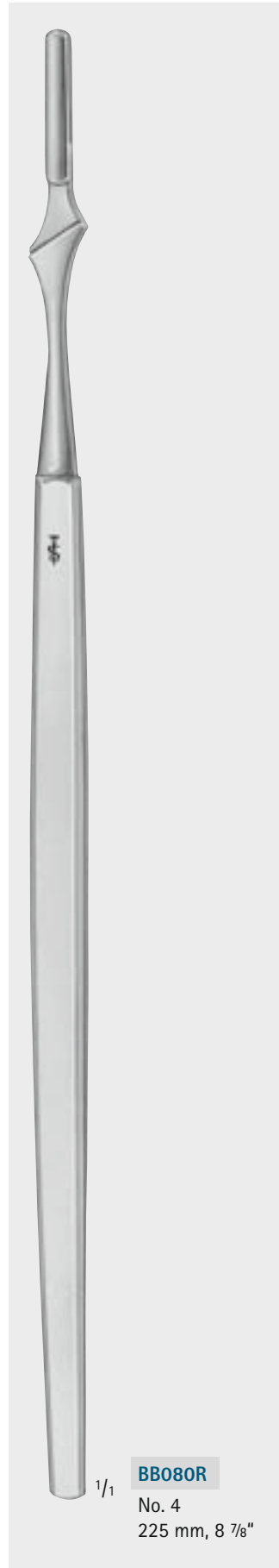

BB080R

No. 4
225 mm, 8 7/8"



BB088R

No. 8
130 mm, 5 1/8"



BB089R

145 mm, 5 3/4"

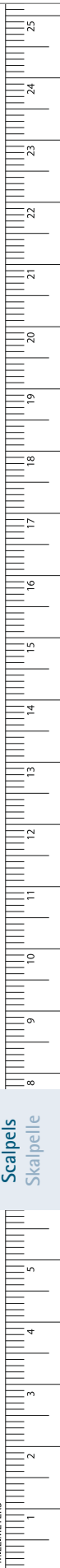

Scalpels – Skalpelle

Sterile Scalpel Blades

Sterilklingen

BB510-BB542 / 16600495-16615492

Sterile scalpel blades
fitting handles on page 7 and 8

Sales unit:

PAK = Package of 100 pieces
in dispenser package

Sterilklingen

passend zu den Griffen auf Seite 7 und 8

Bestelleinheit:

PAK = Packung à 100 Stück
in Spenderpackung



1/1

Carbon Steel **BB510**

Stainless Steel **16600495**

Fig. 10



1/1

BB511

16600509

Fig. 11



1/1

BB512

16600517

Fig. 12



1/1

BB513

16615492

Fig. 13



1/1

Carbon Steel **BB515**

Stainless Steel **16600525**

Fig. 15



1/1

BB515-1

Fig. 15-1



1/1

BB515-C

Fig. 15-C



1/1

BB540

Fig. 40
double cutting
doppelschneidig



1/1

BB542

Fig. 42
double cutting
doppelschneidig

Scalpels
Skalpelle

INCHES

Scalpels – Skalpelle

Sterile Scalpel Blades, Stitch Cutter

Sterilklingen, Fadenmesser

BB518-BB536 / 16600541-16616634

Sterile scalpel blades
 fitting handles on page 9
 Sales unit:
 PAK = Package of 100 pieces
 in dispenser package
 Sterilklingen
 passend zu den Griffen auf Seite 9
 Bestelleinheit:
 PAK = Packung à 100 Stück
 in Spenderpackung



1/1

Carbon Steel **BB518**
 Stainless Steel **16600541**
 Fig. 18



1/1

BB519
 Fig. 19



1/1

BB520
16600550
 Fig. 20



1/1

BB521
16600568
 Fig. 21



1/1

Carbon Steel **BB522**
 Stainless Steel **16600576**
 Fig. 22



1/1

BB523
16600584
 Fig. 23



1/1

BB524
16600592
 Fig. 24



1/1

BB525
16616634
 Fig. 25



1/1

BB536
16615522
 Fig. 36



1/1

Stitch cutter
 Sales unit:
 PAK = Package of 100 pieces
 Fadenmesser
 Bestelleinheit:
 PAK = Packung à 100 Stück

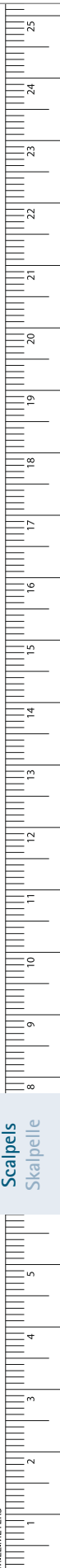

Scalpels
 Skalpelle

Scalpels - Skalpelle

Scalpel Handles for Microsurgery Blades

Skalpellgriffe für mikrochirurgische Klingen



- Titanium
- Titan

- ERGOPLANT



BB045T

145 mm, 5 3/4"



DX305R

150 mm, 6"



BB046R

135 mm, 5 1/4"



BB048R

155 mm, 6 1/8"



CASPAR

BB052R

180 mm, 7"



BB054R

200 mm, 7 7/8"

Scalpels – Skalpelle

Scalpel Handle for Microsurgery Blades – Microsurgery Blades Skalpellgriff für mikrochirurgische Klingen – Mikrochirurgische Klingen

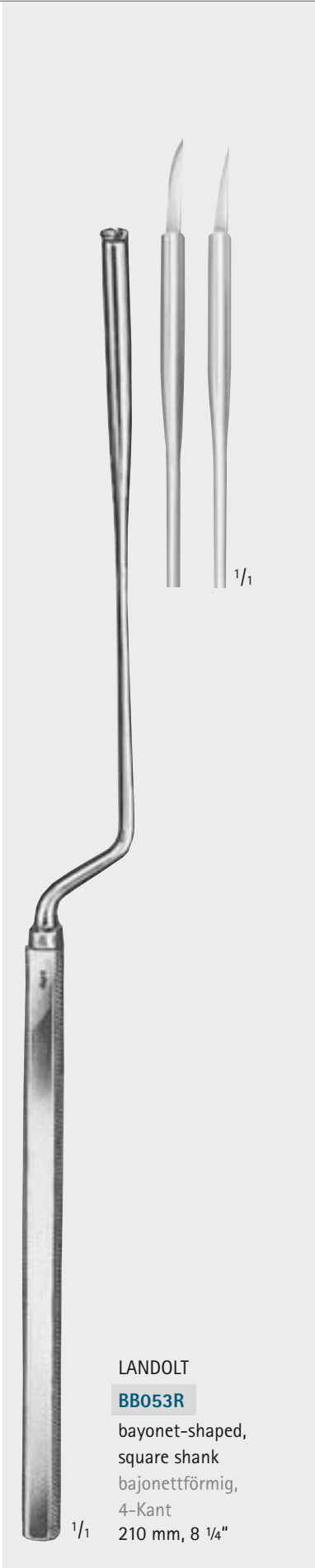

LANDOLT

BB053R

bayonet-shaped,
square shank
bajonettförmig,
4-Kant
210 mm, 8 1/4"

1/1



1/1

YASARGIL

BB331R

Arachnoid blade, diam. 1.5 mm

Sales unit:

PAK = Package of 10 pieces

Tellermesser, Ø 1,5 mm

Bestelleinheit

PAK = Packung à 10 Stück



1/1

YASARGIL

BB332R

Arachnoid blade, diam. 2.5 mm

Sales unit:

PAK = Package of 10 pieces

Tellermesser, Ø 2,5 mm

Bestelleinheit

PAK = Packung à 10 Stück



1/1

BB361R

PAK =

Package of 10 pieces

Packung à 10 Stück



1/1

BB362R

PAK =

Package of 10 pieces

Packung à 10 Stück



1/1

BB363R

ST =

Package of 1 piece

Packung à 1 Stück



1/1

BB364R

PAK =

Package of 10 pieces

Packung à 10 Stück



1/1

BB365R

PAK =

Package of 10 pieces

Packung à 10 Stück



1/1

60°

BB366R

ST =

Package of 1 piece

Packung à 1 Stück



1/1

BB367R

PAK =

Package of 10 pieces

Packung à 10 Stück



1/1

BB368R

PAK =

Package of 10 pieces

Packung à 10 Stück



1/1

BB369R

ST =

Package of 1 piece

Packung à 1 Stück

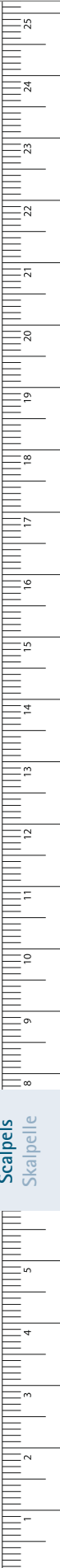

Scalpels – Skalpelle

Diamond Knives

Diamant-Messer

Diamond Knives
Diamant-Messer

REM view of a common scalpel blade
REM Vergrößerung einer gängigen Skalpellklinge

REM view of a diamond knife blade
REM Vergrößerung einer Diamant-Messerklinge

- Blade made of natural diamond
Klinge aus Naturdiamant
 - Superior mechanical stability and elasticity of the blade
Hohe mechanische Stabilität und Elastizität der Klinge
 - Sustained sharpness
Lang anhaltende Schärfe
 - Excellently clean, precise and force-free incisions
Hochgradig saubere, präzise und kraftlose Schnitte
 - Protection mechanism for safe storage of the blade inside the handle
Schutzmechanismus zur sicheren Lagerung der Schneideklinge im Griff
 - Color coded TITANIUM handles
Kodierung durch farbige TITANIUM-Handgriffe
 - Four different cutting geometries:
 - round, retrograde, wedge or lancet blade
- Vier verschiedene Schneidegeometrien:
- Rund-, Retrograd-, Keil-, und Lanzettenklinge

Diamond knives

- Due to the properties of their unique blade material, diamond knives offer excellent cutting characteristics for highly clean, precise and force-free incisions especially in cardiovascular and thoracic surgery.

Diamantmesser

- Diamantmesser haben aufgrund ihrer Materialeigenschaften hervorragende Schneideigenschaften, welche sich insbesondere im Einsatz in der Herz-, Thorax- und Gefäßchirurgie durch hochgradig saubere, präzise und kraftlose Schnitte auszeichnen.

Scalpels – Skalpelle

Diamond Knives

Diamant-Messer



FD113D

Round blade,
gold-colored, 7 facets
Rund-Klinge,
Gold, 7 Facetten
205 mm, 8"

1/1



FD115D 45°

Wedge blade,
black
Keil-Klinge,
Schwarz
205 mm, 8"

1/1



FD116D 60°

Lancet blade,
bronze-colored
Lanzetten-Klinge,
Bronze
205 mm, 8"

1/1



Scalpels
Skalpelle



Scalpels - Skalpelle



Scalpels
Skalpelle

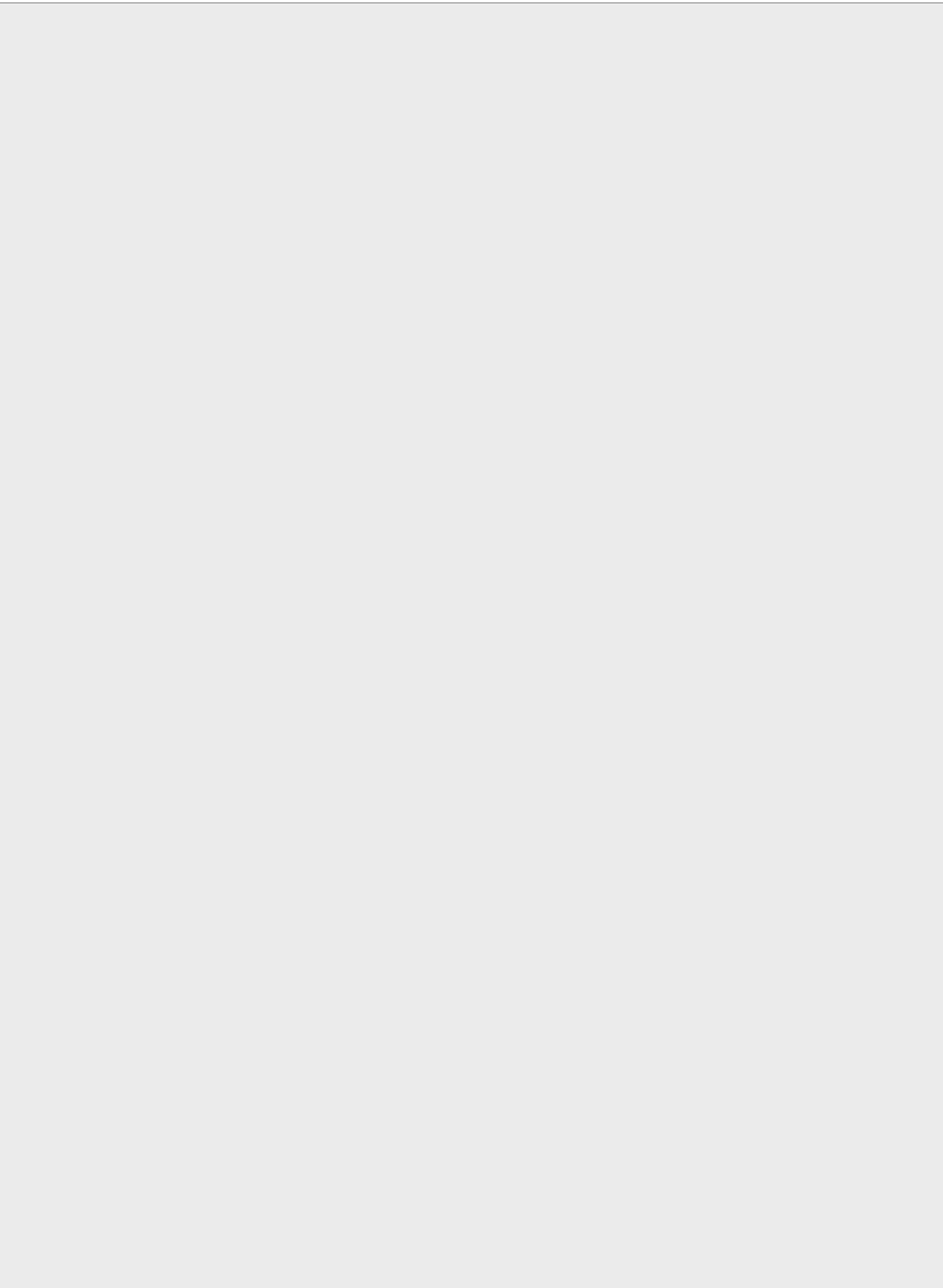

General Surgical Instruments Chirurgische Instrumente

- Scissors
- Scheren

Scissors – Scheren

Noir® Dissecting Scissors

Noir® Präparierscheren

Noir®

The special qualities of the Noir® dissecting scissors allow dissection that is finer than ever before. Noir®. Gentle dissection with minimum use of force.

- Soft but sharp.
- Power with minimum force.
- Pure performance.

The combination of the renowned Aesculap tungsten carbide technology with the Aesculap® Noir® coating results in an extremely high surface hardness and therefore high wear resistance in daily hospital use.

Die spezielle Eigenschaften der Noir® Präparierscheren ermöglichen ein Präparieren noch feiner und sicherer als je zuvor. Noir®. Schonendes Präparieren mit minimalen Kraftaufwand.

- Sanfte Schärfe.
- Stärke die kaum Kraft braucht.
- Wirkung pur.

Die Verbindung der bewährten Aesculap Hartmetall Technologie mit der Aesculap® Noir® Beschichtung führt zu einer extrem hohen Oberflächenhärte. Noir®. Die Präparierscheren mit der hohen Verschleißbeständigkeit im täglichen Klinikeinsatz.



Microtome edge – the extremely sharp cutting edge of the scissors blade facilitates gentle cutting of tissue with minimal use of force.

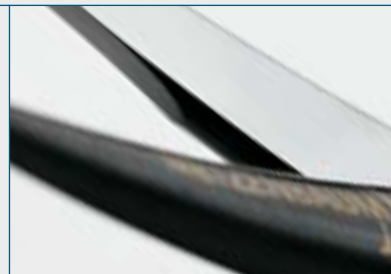

Mikrotomschliff – besonders scharfer Anschliff des Scherenblattes für sanftes Durchtrennen des Gewebes bei minimalem Kraftaufwand.



Wavecut prevents tissue from slipping out during the cutting process.



Wellenschliff verhindert das Herausgleiten des Gewebes während des Schneidens.

Scissors – Scheren

Noir® Dissecting Scissors

Noir® Präparierscheren



- Wavecut prevents tissue from slipping out during the cutting process
- Wellenschliff verhindert das Herausgleiten des Gewebes während des Schneidens

- grazil
- very delicate design
- besonders schlankes Design

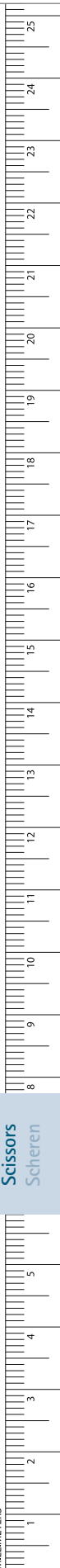

BC210B-BC211WB
110 mm, 4 1/4"

grazil

BC210B
straight
gerade

grazil

BC211B
curved
gebogen

BC211WB
Wavecut
curved
Wellenschliff
gebogen

BC257B-BC257WB
115 mm, 4 1/2"

grazil

BC257B
curved
gebogen

BC257WB
Wavecut
curved
Wellenschliff
gebogen

Scissors – Scheren

Noir® Dissecting Scissors

Noir® Präparierscheren



- Wavecut prevents tissue from slipping out during the cutting process
- Wellenschliff verhindert das Herausgleiten des Gewebes während des Schneidens

- grazil
very delicate design
besonders schlankes Design



Scissors
Scheren



BABY-METZENBAUM

BC259B-BC259WB

145 mm, 5 3/4"



BC259B

curved
gebogen

BC259WB

Wavecut
curved
Wellenschliff
gebogen



METZENBAUM

BC261B-BC261WB

145 mm, 5 3/4"



BC261B

curved
gebogen

BC261WB

Wavecut
curved
Wellenschliff
gebogen

Scissors – Scheren
 Noir® Dissecting Scissors
 Noir® Präparierscheren



METZENBAUM

BC263B-BC271WB

180 mm, 7"



BC263B

curved
gebogen

BC263WB

Wavecut
curved
Wellenschliff
gebogen

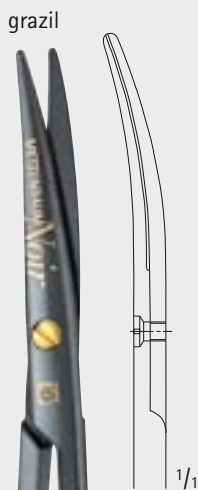

BC271B

curved
gebogen

BC271WB

Wavecut
curved
Wellenschliff
gebogen



TÖNNIS-ADSON

BC273B-BC273WB

175 mm, 6 7/8"



BC273B

curved
gebogen

BC273WB

Wavecut
curved
Wellenschliff
gebogen

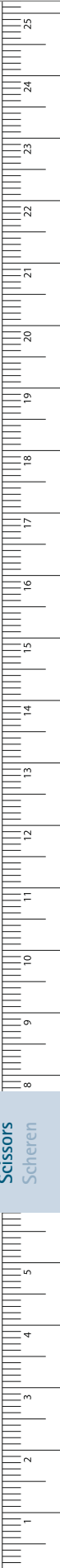

Scissors – Scheren

Noir® Dissecting Scissors

Noir® Präparierscheren



- Wavecut prevents tissue from slipping out during the cutting process
- Wellenschliff verhindert das Herausgleiten des Gewebes während des Schneidens

- grazil
very delicate design
besonders schlankes Design



Scissors
Scheren



METZENBAUM
BC265B-BC275WB
200 mm, 7 7/8"



grazil

BC265B
curved
gebogen

BC275B
curved
gebogen

BC265WB
Wavecut
curved
Wellenschliff
gebogen

BC275WB
Wavecut
curved
Wellenschliff
gebogen



MAYO
BC252B-BC253WB
170 mm, 6 3/4"



BC252B
straight
gerade

BC253B
curved
gebogen

BC253WB
Wavecut
curved
Wellenschliff
gebogen

Scissors – Scheren
 Noir® Dissecting Scissors
 Noir® Präparierscheren



BC283B-BC284WB

165 mm, 6 1/2"



MAYO-LEXER

BC284B

curved
gebogen

MAYO-LEXER

BC284WB

Wavecut
curved
Wellenschliff
gebogen

grazil



LEXER

BC283B

curved
gebogen

LEXER

BC283WB

Wavecut
curved
Wellenschliff
gebogen

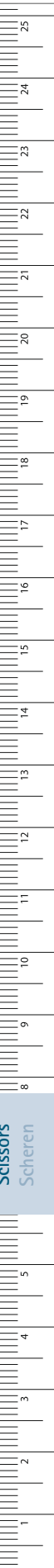

Scissors
Scheren

MILLIMETERS

Scissors – Scheren

DUROTIP® Delicate Scissors

DUROTIP® Feine Scheren

- **DUROTIP® Scissors**
with inserted tungsten carbide cutting edges
 - 3 years guarantee!
 - Excellent cutting accuracy
 - Long working life
 - Gold-plated rings
- **DUROTIP®-Scheren**
mit eingesetzten Hartmetall-Schneiden
 - 3 Jahre Garantie!
 - Hervorragende Schnitthaltigkeit
 - Lange Lebensdauer
 - Vergoldete Ringe
- **grazil**
very delicate design
sehr schlankes Design



BC210R

BC211R

BC210R-BC211R

Ligature scissors
Fadenscheren
110 mm, 4 1/4"



1 blade serrated
1 Schneide gezahnt

GOLDMAN-FOX

DO250R

130 mm, 5 1/8"



DO208R

DO209R

DO208R-DO209R

120 mm, 4 3/4"

Scissors – Scheren

DUROTIP® Surgical Scissors

DUROTIP® Chirurgische Scheren

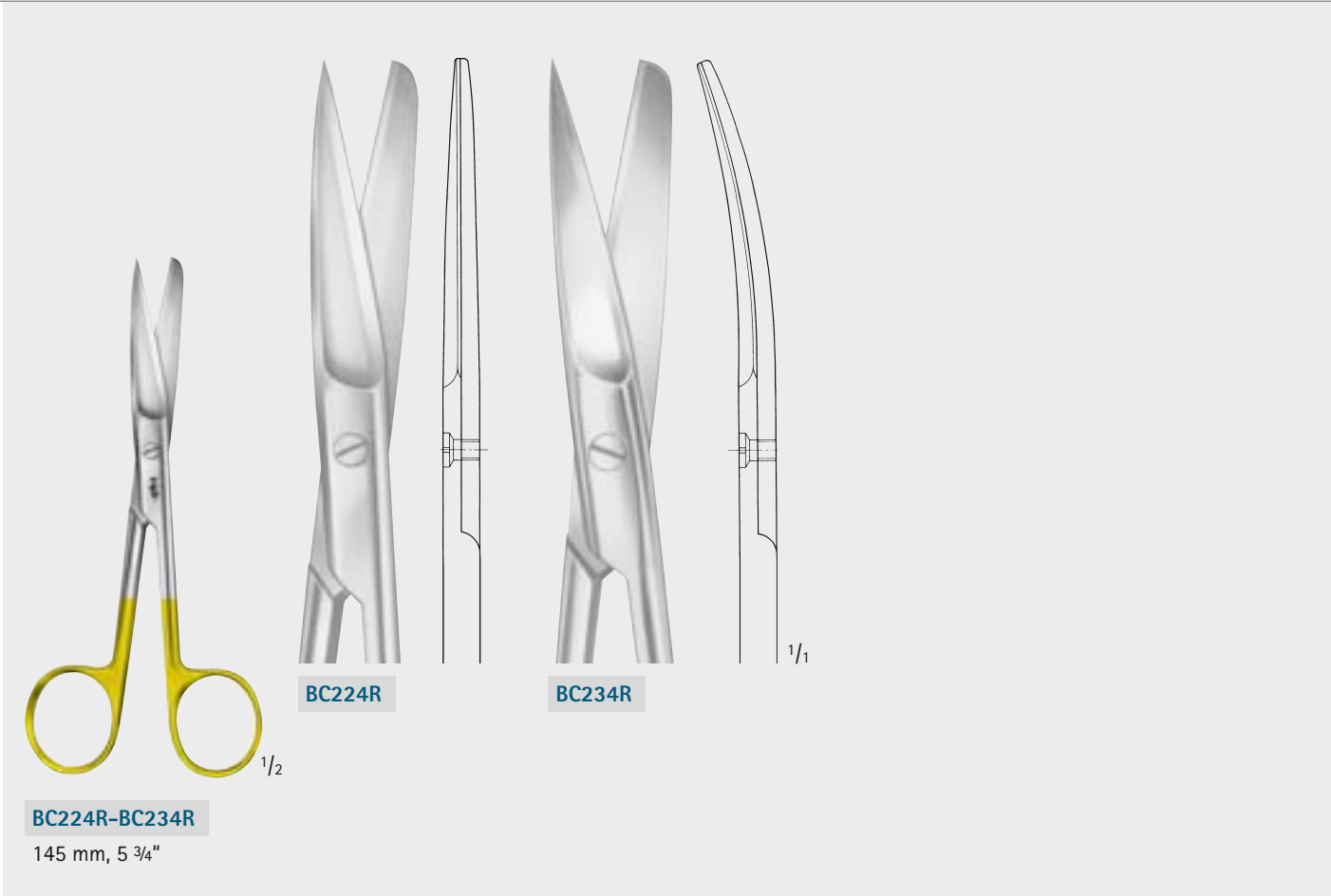

BC224R-BC234R

145 mm, 5 3/4"

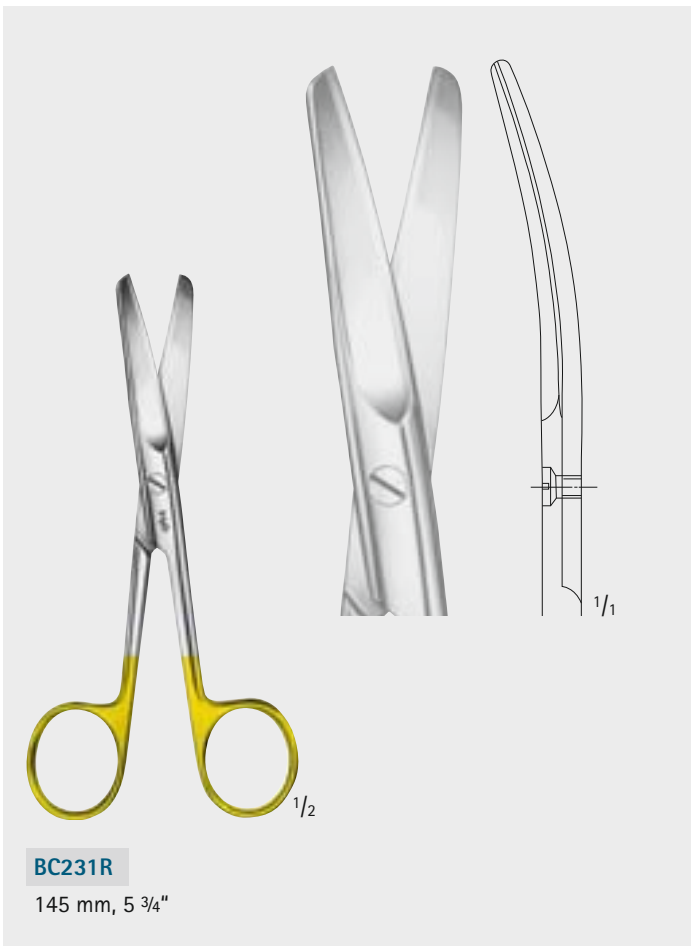

BC231R

145 mm, 5 3/4"

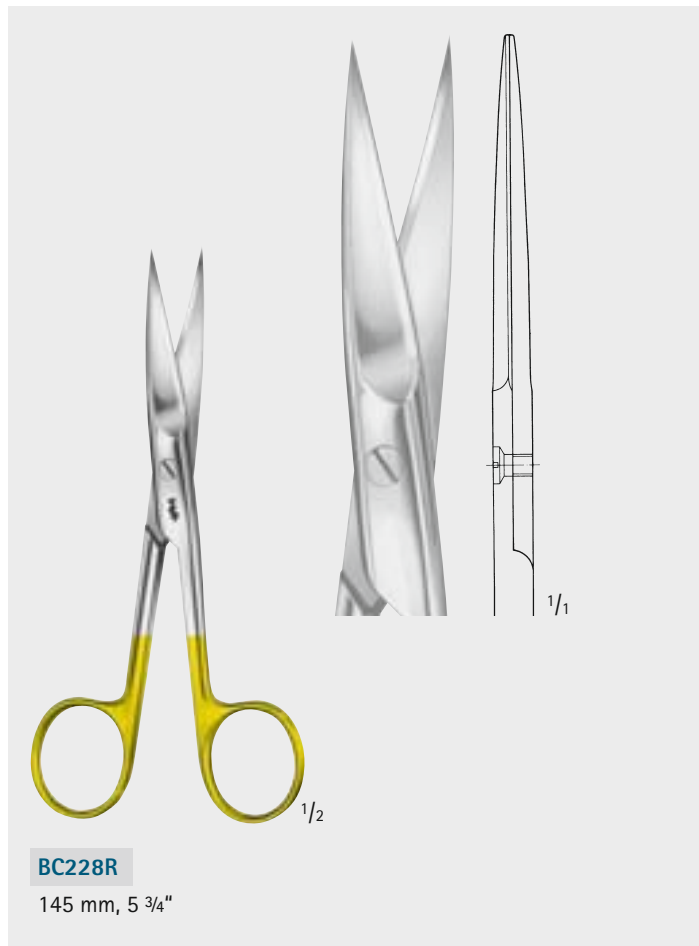

BC228R

145 mm, 5 3/4"

Scissors
Scheren

MILLIMETERS

Scissors – Scheren

DUROTIP® Dissecting Scissors

DUROTIP® Präparierscheren



MAYO

BC250R-BC253R



BC250R

140 mm
5 1/2"



BC252R

170 mm
6 3/4"



BC251R

140 mm
5 1/2"



BC253R

170 mm
6 3/4"

1/1



MAYO

BC242R-BC559R



BC242R

170 mm
6 3/4"



BC558R

230 mm
9"



BC243R

170 mm
6 3/4"



BC559R

230 mm
9"

1/1

Scissors
Scheren

Scissors – Scheren
DUROTIP® Dissecting Scissors
DUROTIP® Präparierscheren

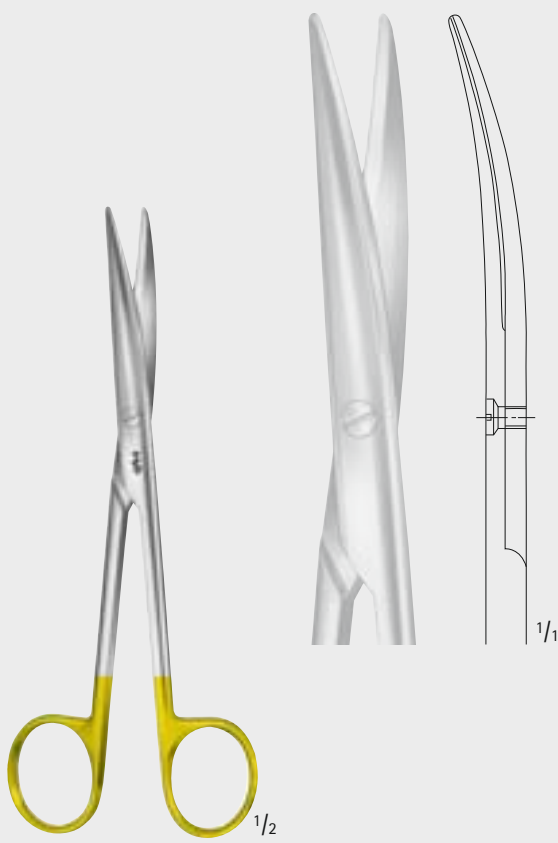

LEXER
BC283R
narrow
schmal
165 mm, 6 1/2"

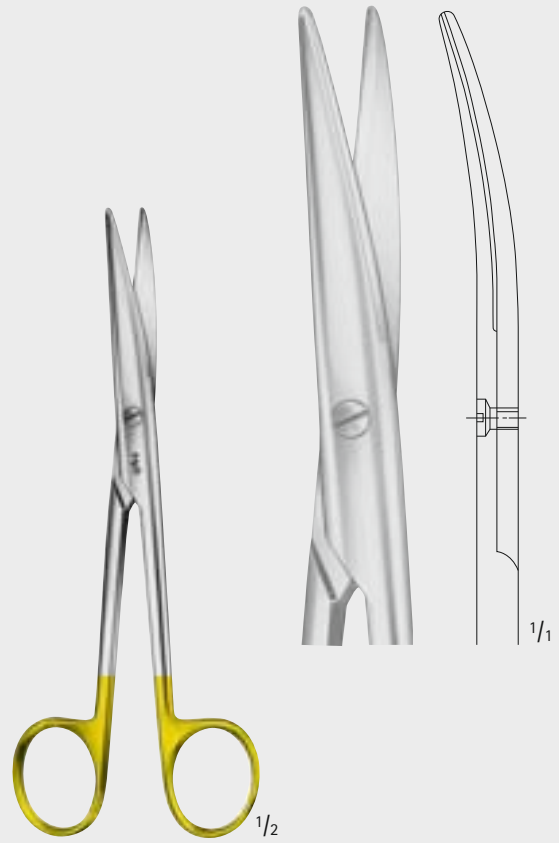

MAYO-LEXER
BC284R
165 mm, 6 1/2"

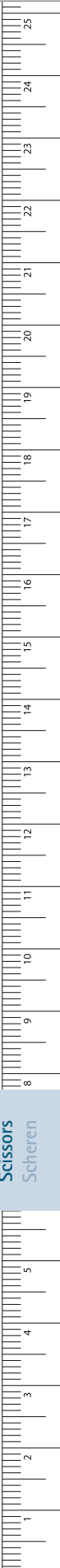

Scissors – Scheren

DUROTIP® Dissecting Scissors

DUROTIP® Präparierscheren



BC256R

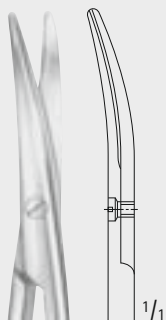

BC257R

BC256R-BC257R

115 mm, 4 1/2"

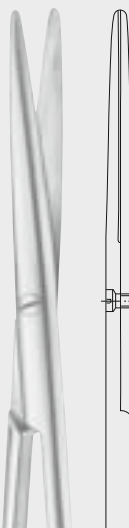

BC258R

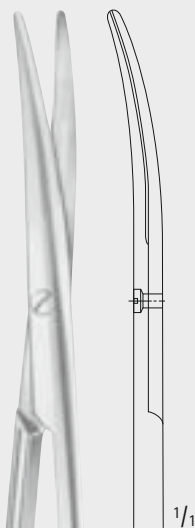

BC259R

BABY-METZENBAUM

BC258R-BC259R

145 mm, 5 3/4"

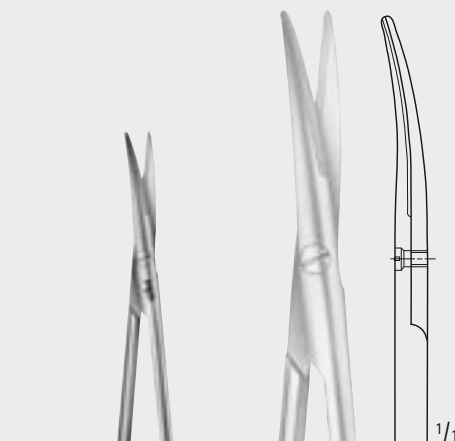

TÖNNIS-ADSON

BC273R

175 mm, 6 7/8"

Scissors – Scheren

DUROTIP® Dissecting Scissors

DUROTIP® Präparierscheren



METZENBAUM

BC260R-BC265R



BC260R

145 mm
5 3/4"

BC262R

180 mm
7"

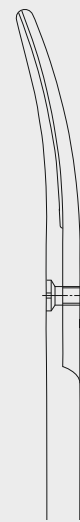
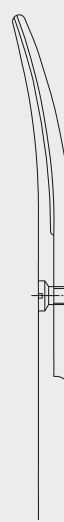

BC261R

145 mm
5 3/4"

BC263R

180 mm
7"

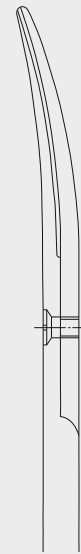

1/1

BC265R

200 mm
7 7/8"



METZENBAUM

BC270R-BC277R

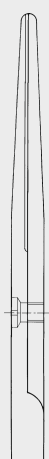

BC270R

180 mm
7"

BC274R

200 mm
7 7/8"

BC276R

230 mm
9"



BC271R

180 mm
7"

BC275R

200 mm
7 7/8"



1/1

BC277R

230 mm
9"

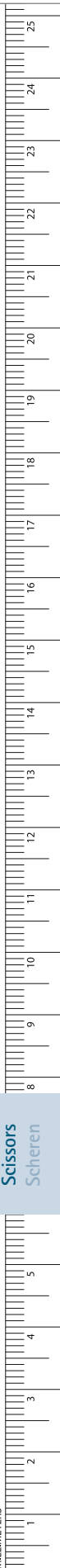

Scissors
Scheren

MILLIMETERS

Scissors – Scheren

DUROTIP® Wavecut Scissors

DUROTIP® Scheren mit Wellenschliff

Wavecut prevents tissue from slipping out
Wellenschliff verhindert das Herausgleiten des Gewebes



W directly after the catalog number indicates that the resp. item has one serrated cutting edge.

(When ordering please indicate together with the catalog number e.g. BC211W)

Artikel mit dem W Zusatz sind auf einer Schnittfläche mit Wellenschliff versehen (bei Bestellungen bitte angeben z.B. BC211W)

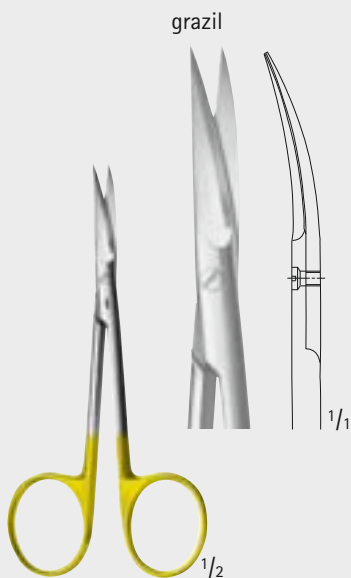

BC211W
Ligature scissors
Fadenschere
110 mm, 4 1/4"

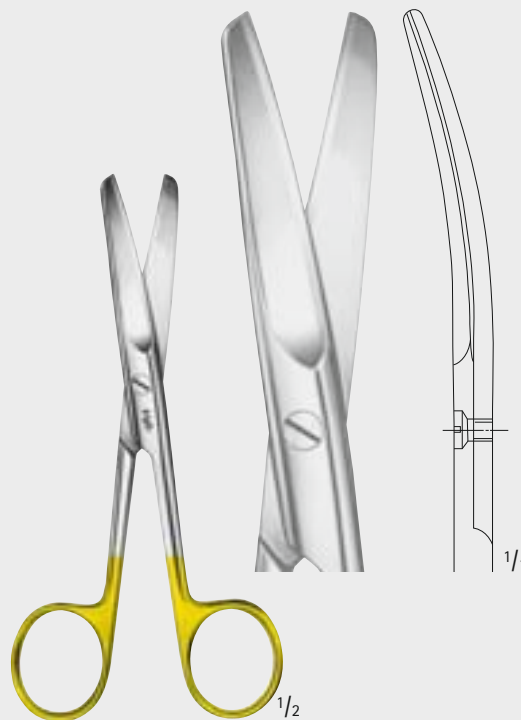

BC231W
Surgical scissors
Chirurgische Schere
145 mm, 5 3/4"

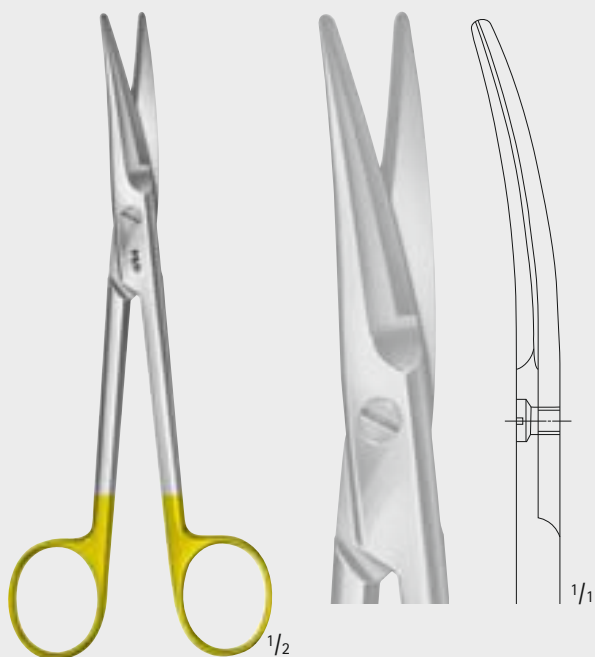

MAYO
BC253W
Dissecting scissors
Präparierschere
170 mm, 6 3/4"

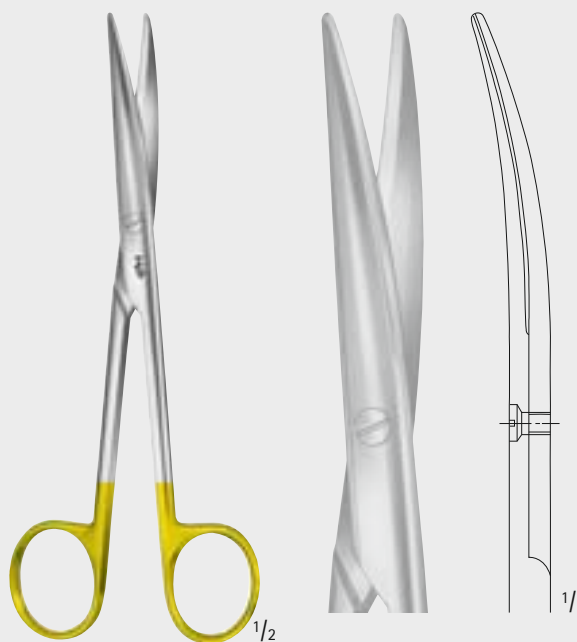

LEXER
BC283W
Dissecting scissors, slender
Präparierschere, schmal
165 mm, 6 1/2"

Scissors – Scheren

DUROTIP® Wavecut Dissecting Scissors

DUROTIP® Präparierscheren mit Wellenschliff



1/2

MAYO-LEXER
BC284W
165 mm, 6 1/2"

Detailed description: This panel shows the Mayo-Lexer scissors (BC284W). It includes a full view of the scissors with yellow handles, a side view of the blades, and a technical drawing of the blade tip. The blades are long and straight with a slight curve at the tip. The handles are large and oval-shaped.

grazil



1/2

BC257W
115 mm, 4 1/2"

Detailed description: This panel shows the Durotip Wavecut Dissecting Scissors (BC257W). It includes a full view of the scissors with yellow handles, a side view of the blades, and a technical drawing of the blade tip. The blades are shorter and have a distinct wavy cut. The handles are smaller and oval-shaped. The word 'grazil' is written above the side view.

grazil



1/2

BABY-METZENBAUM
BC259W
145 mm, 5 3/4"

Detailed description: This panel shows the Baby-Metzenbaum scissors (BC259W). It includes a full view of the scissors with yellow handles, a side view of the blades, and a technical drawing of the blade tip. The blades are long and straight with a slight curve at the tip. The handles are large and oval-shaped. The word 'grazil' is written above the side view.

grazil

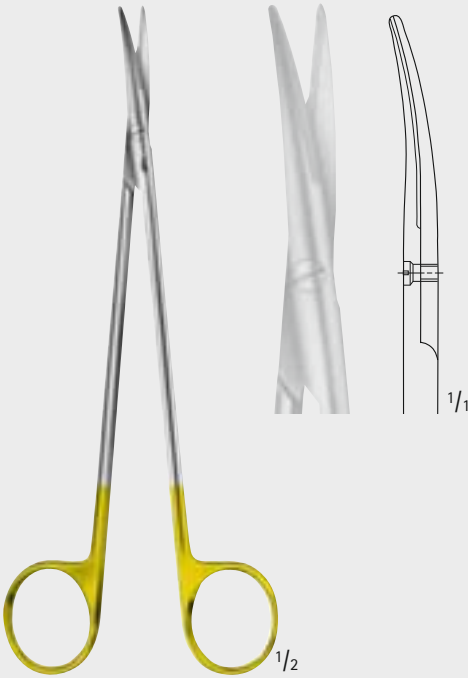

1/2

TÖNNIS-ADSON
BC273W
175 mm, 6 7/8"

Detailed description: This panel shows the Tönnis-Adson scissors (BC273W). It includes a full view of the scissors with yellow handles, a side view of the blades, and a technical drawing of the blade tip. The blades are long and straight with a slight curve at the tip. The handles are large and oval-shaped. The word 'grazil' is written above the side view.

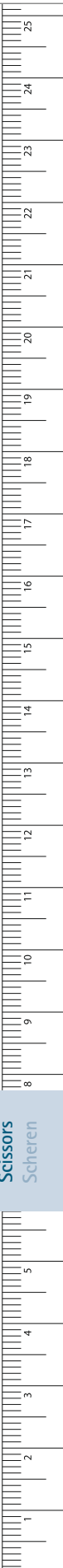

Scissors – Scheren

DUROTIP® Wavecut Dissecting Scissors

DUROTIP® Präparierscheren mit Wellenschliff



grazil

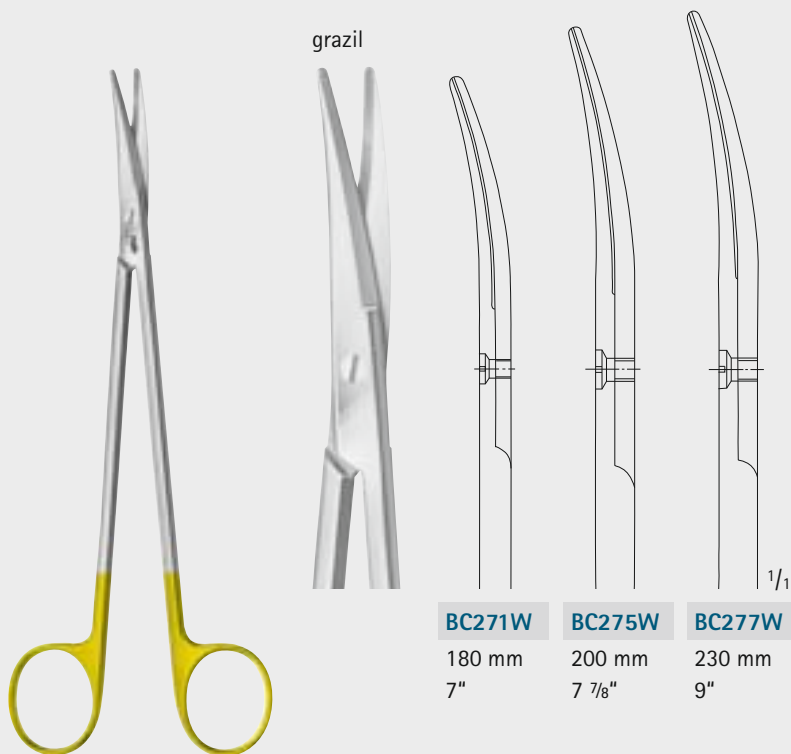

BC271W

180 mm
7"

BC275W

200 mm
7 7/8"

BC277W

230 mm
9"

METZENBAUM

BC271W-BC277W



BC261W

145 mm
5 3/4"

BC263W

180 mm
7"

BC265W

200 mm
7 7/8"

METZENBAUM

BC261W-BC265W

Scissors
Scheren

INCHES

Scissors – Scheren

DUROTIP® Wavecut Dissecting Scissors

DUROTIP® Präparierscheren mit Wellenschliff

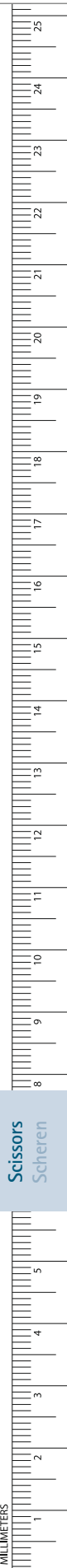
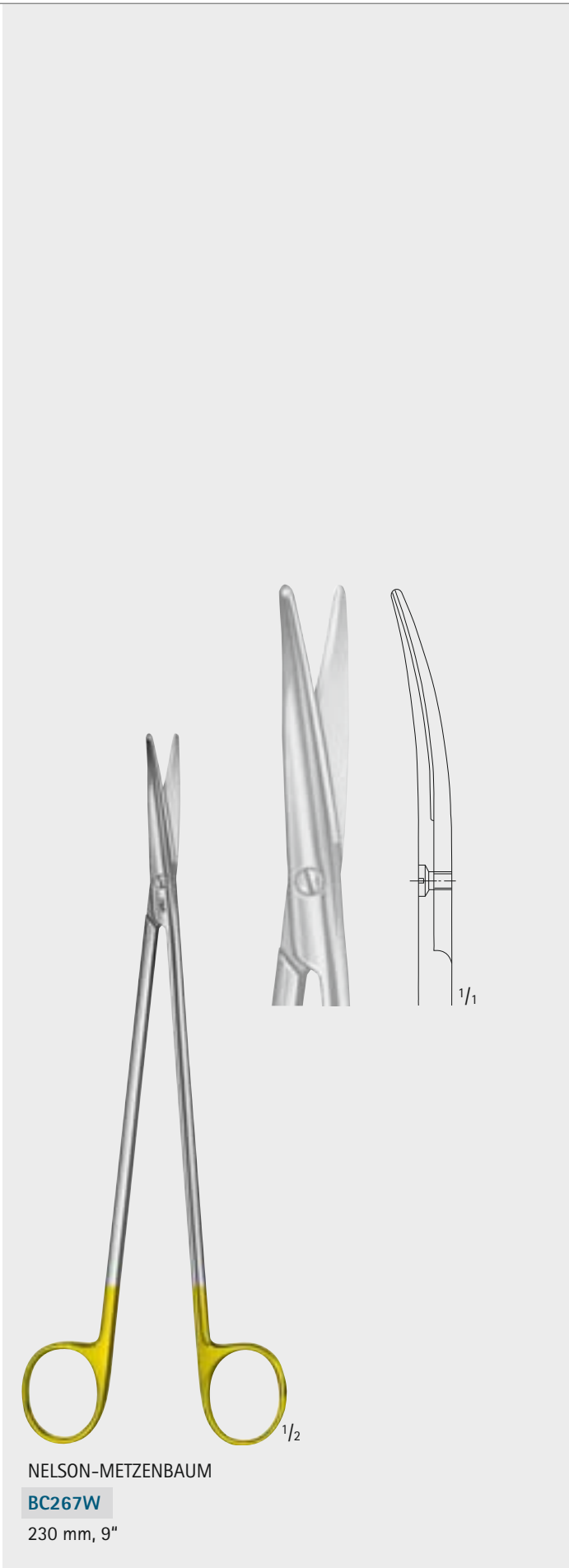

Scissors – Scheren

DUROTIP® Wavecut Ligature Scissors

DUROTIP® Fadenscheren mit Wellenschliff

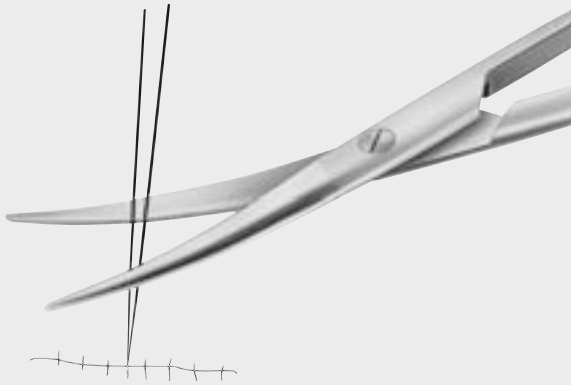

- Especially for cutting suture materials
 - Tungsten carbide inserts ensure permanent sharp cutting edge (also in the distal area of the blades)
 - Wavecut prevents suture materials from slipping out
 - DUROTIP® ligature scissors are identified by 1 goldplated ring
- Speziell zum Schneiden von Nahtmaterial
 - Hartmetalleinlagen gewähren dauerhafte Schnittschärfe (auch im distalen Bereich der Scherenblätter)
 - der Spezial-Wellenschliff verhindert das Abgleiten des Nahtmaterials
 - DUROTIP® Ligaturscheren sind gekennzeichnet mit 1 vergoldeten Ring



BC294W

145 mm, 5 3/4"

BC295W

180 mm, 7"

BC294W-BC295W

Scissors
Scheren

INCHES

Scissors – Scheren

Supercut Scissors

Supercut Scheren

- 1 Cutting blade with sharp Microtome edge
- 1 Cutting blade with Wavecut
 - Identification:
Black marked rings, shiny instrument surface



- 1 Schneideblatt mit Mikrotomschliff
- 1 Schneideblatt mit Wellenschliff
 - Kennzeichnung:
Schwarze Ringe, glänzende Oberfläche



Microtome edge

- The extremely sharp cutting edge of the scissors blade facilitates gentle cutting of tissue with minimal use of force



Microtome edge

- Besonders scharfer Anschlag des Scherenblattes für sanftes Durchtrennen des Gewebes bei minimalem Kraftaufwand



- Wavecut prevents tissue from slipping out during the cutting process



- Wellenschliff verhindert das Herausgleiten des Gewebes während des Schneidens

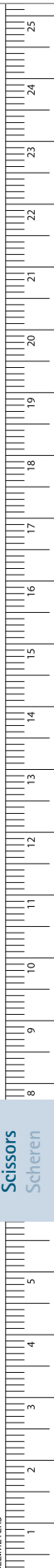

Scissors
Scheren

MILLIMETERS

Scissors – Scheren

Supercut Scissors

Supercut Scheren

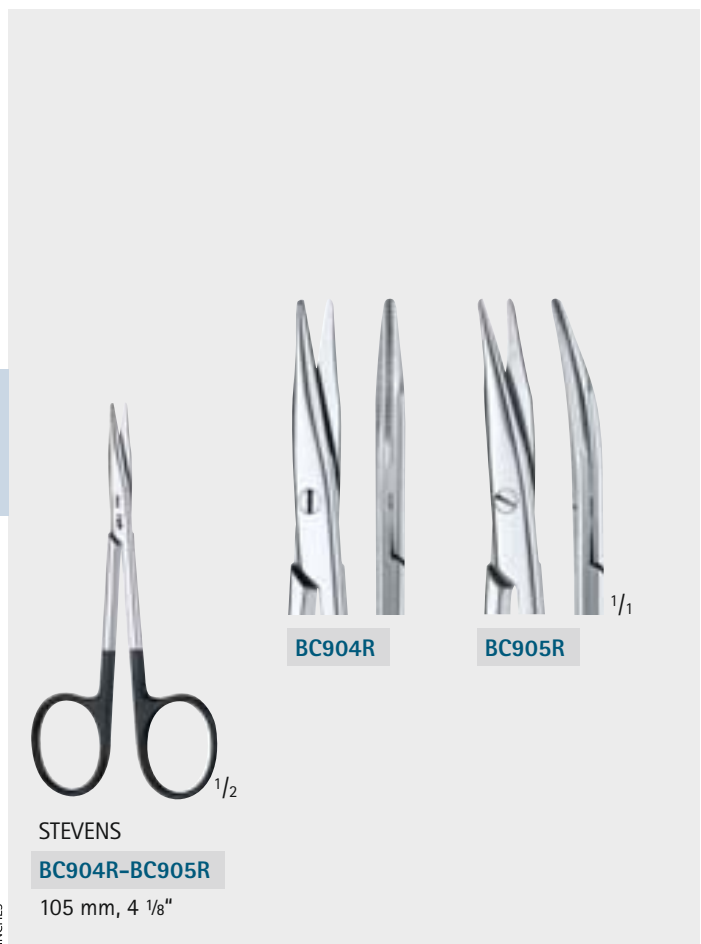

Scissors
Scheren

Scissors – Scheren

Supercut Scissors

Supercut Scheren

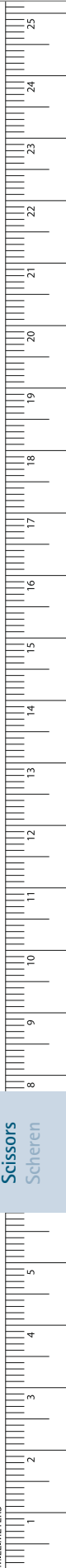

Scissors – Scheren

Supercut Scissors

Supercut Scheren



BC916R

BC917R

JOSEPH

BC916R-BC917R

150 mm, 6"



BC926R

BC927R

MAYO

BC926R-BC927R

145 mm, 5 3/4"



BC924R

BC925R

MAYO

BC924R-BC925R

165 mm, 6 1/2"

Scissors – Scheren

Supercut Scissors

Supercut Scheren

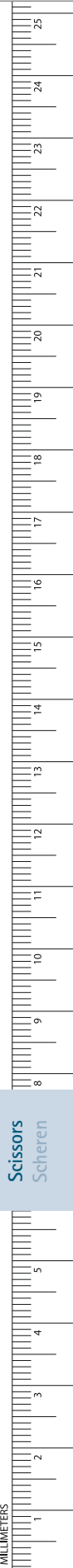
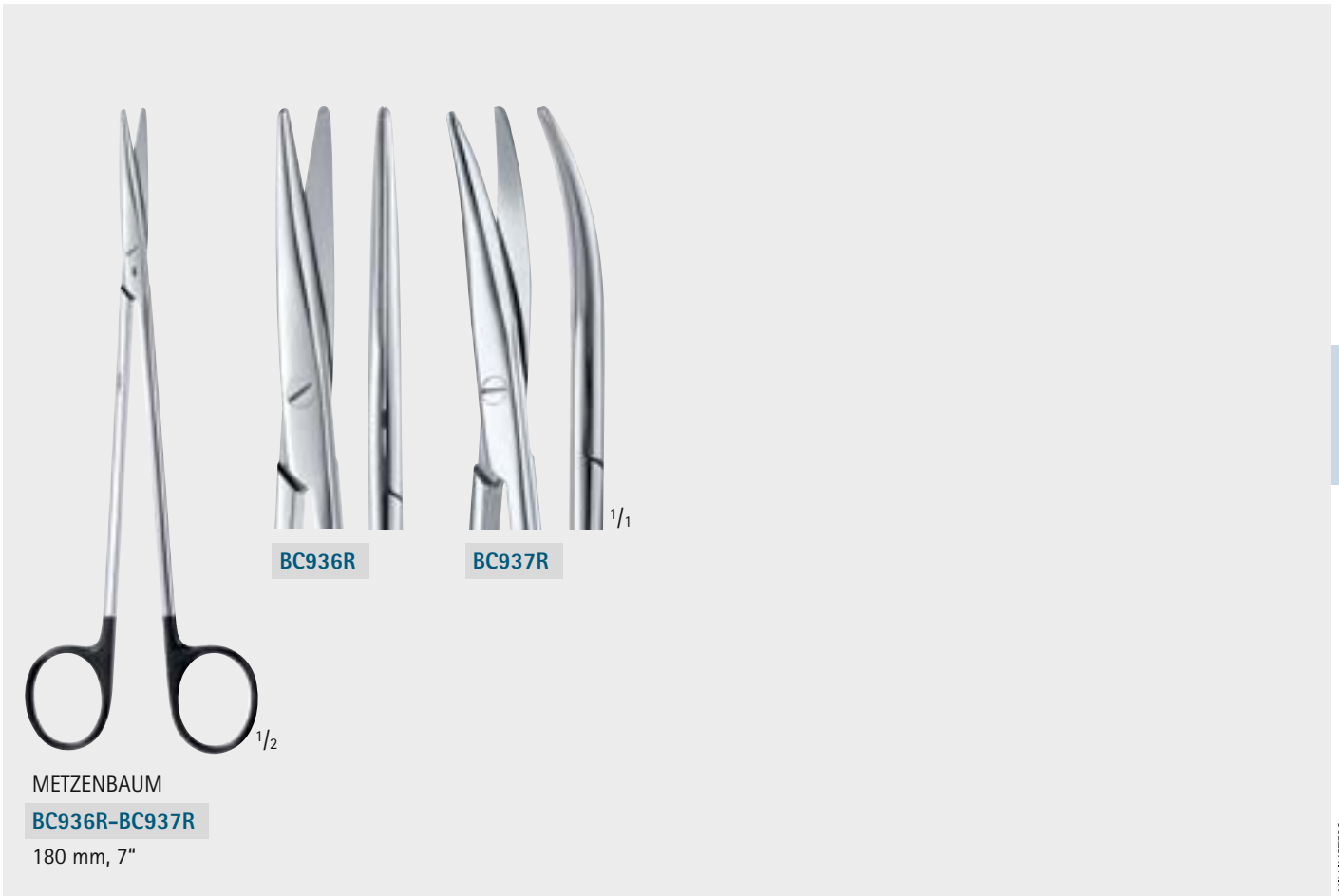

Scissors – Scheren

Supercut Scissors

Supercut Scheren



GORNEY

BC920R

195 mm, 7 3/4"



GORNEY

BC921R

195 mm, 7 3/4"

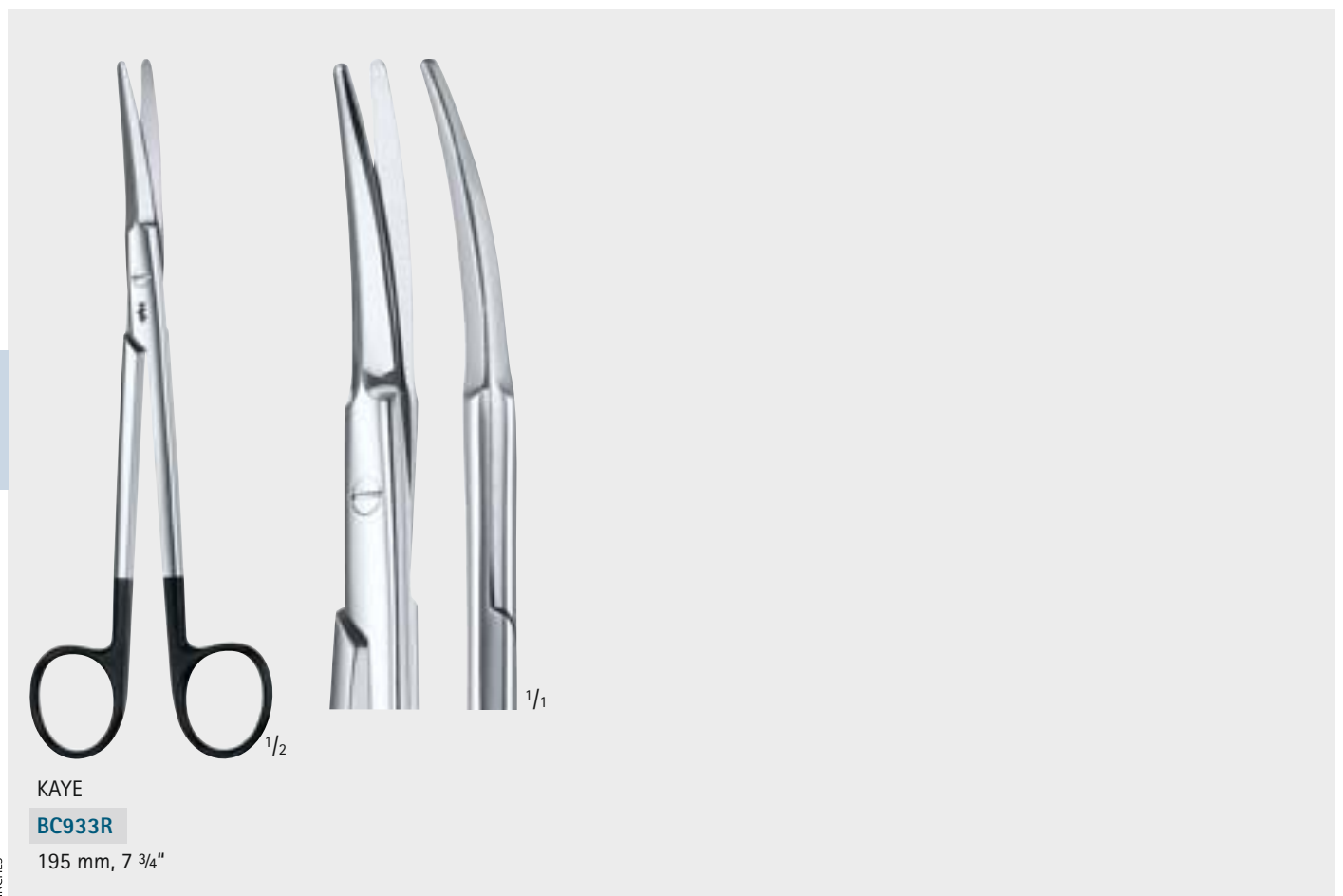

KAYE

BC933R

195 mm, 7 3/4"

Scissors
Scheren

INCHES

Scissors – Scheren

Delicate Scissors

Feine Scheren



BC004R

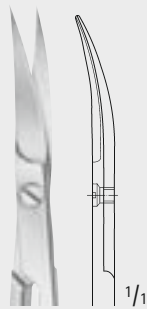

BC005R

BC004R-BC005R

115 mm, 4 1/2"



BC006R

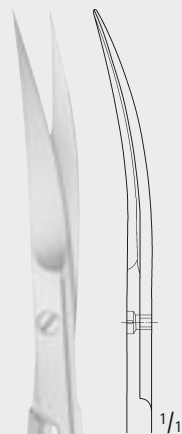

BC007R

JOSEPH

BC006R-BC007R

150 mm, 6"

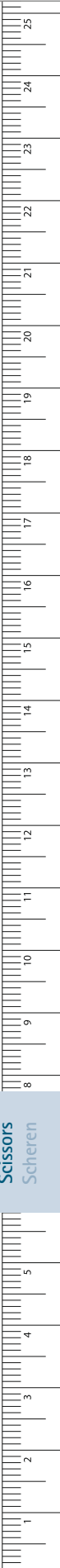

Scissors – Scheren

Delicate Scissors

Feine Scheren

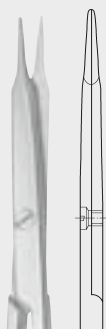

BC008R
sharp
spitz



BC009R
sharp
spitz

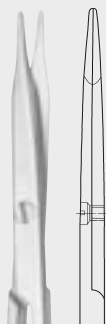

BC010R
blunt
stumpf

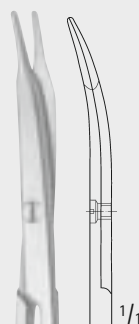

BC011R
blunt
stumpf

STEVENS

BC008R-BC011R

Dissecting scissors

Präparierscheren

115 mm, 4 1/2"

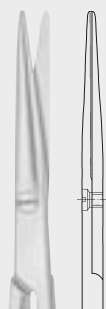

BC020R

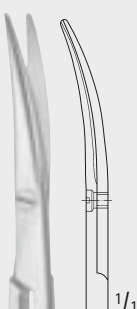

BC021R

BC020R-BC021R

Dissecting- and strabismus scissors

Präparier- und Strabismusscheren

115 mm, 4 1/2"



BC022R

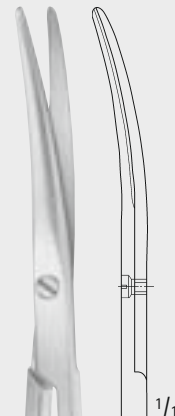

BC023R

METZENBAUM

BC022R-BC023R

Dissecting scissors

Präparierscheren

145 mm, 5 3/4"

Scissors – Scheren

Delicate Scissors

Feine Scheren

REYNOLDS-JAMESON
BC015R
 Vascular scissors
 Gefäßschere
 140 mm, 5 1/2"

BC017R
 Nerve dissecting scissors
 Nerv-Präparierschere
 140 mm, 5 1/2"

blades outside semi-sharp
 Außenkanten der Blätter halbscharf

RAGNELL
BC026R-BC029R
 special flat tips for dissecting
 and undermining the skin
 besonders flache Spitzen zum
 Präparieren und Unterminieren
 der Haut

BC026R
 135 mm
 5 1/4"

BC027R
 135 mm
 5 1/4"

BC029R
 150 mm
 6"

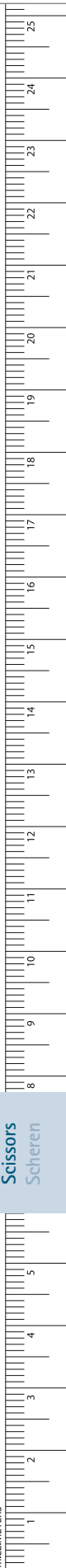

Scissors – Scheren

Delicate Scissors

Feine Scheren



BC100R **BC101R**

BC100R-BC101R
90 mm, 3 1/2"

1/2 1/1

BC056R **BC057R**

BC056R-BC057R
95 mm, 3 3/4"

1/2 1/1

BC060R **BC061R**

BC060R-BC061R
105 mm, 4 1/8"

1/2 1/1

BC064R **BC065R**

BC064R-BC065R
120 mm, 4 3/4"

1/2 1/1

Scissors
Scheren

Scissors – Scheren

Delicate Scissors

Feine Scheren

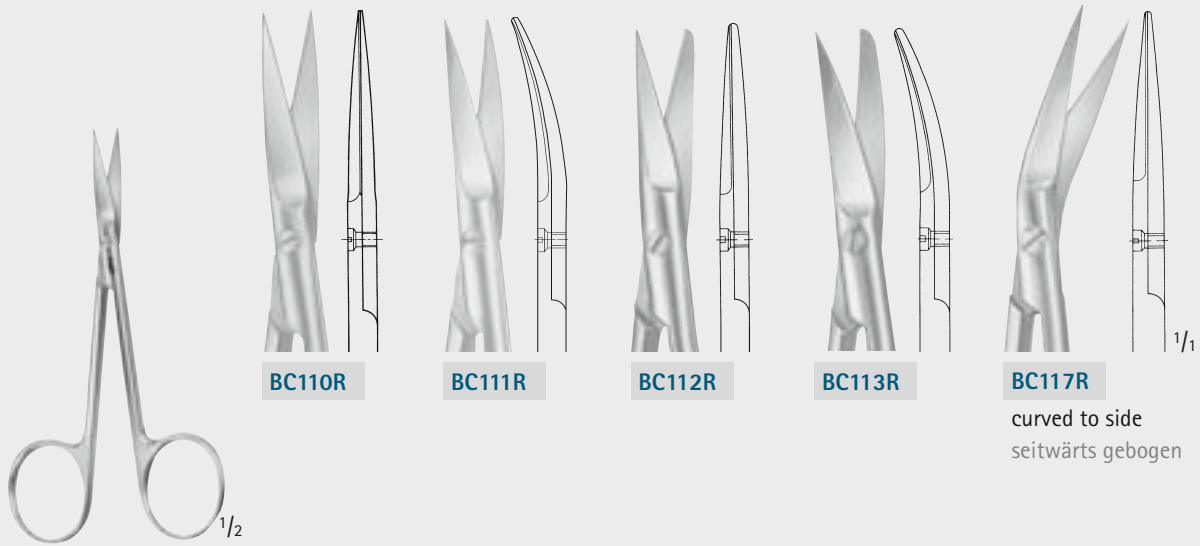

BC110R

BC111R

BC112R

BC113R

BC117R

curved to side
seitwärts gebogen

BC110R–BC117R

110 mm, 4 1/4"

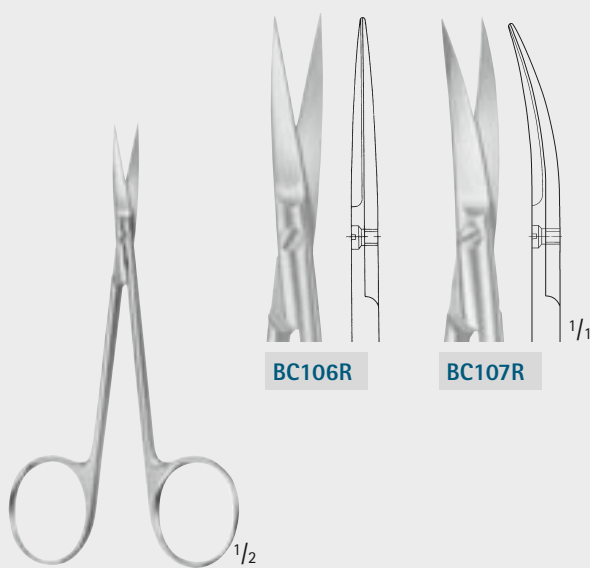

BC106R

BC107R

BC106R–BC107R

115 mm, 4 1/2"

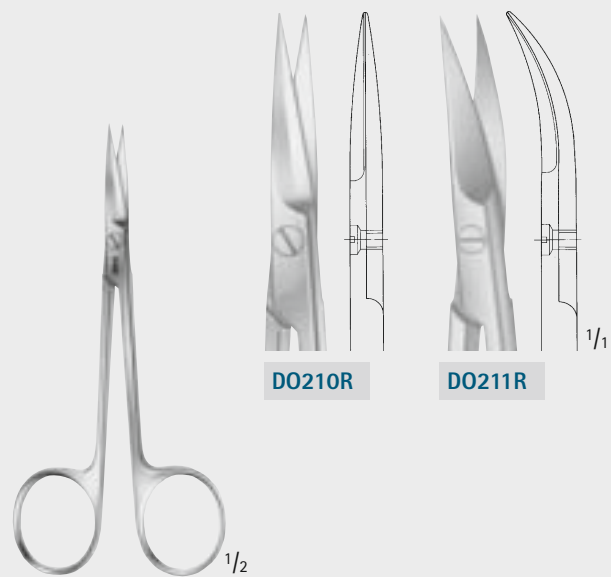

DO210R

DO211R

DO210R–DO211R

120 mm, 4 3/4"

Scissors
Scheren

MILLIMETERS

Scissors - Scheren

Delicate Scissors

Feine Scheren

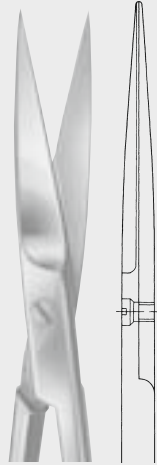

BC130R

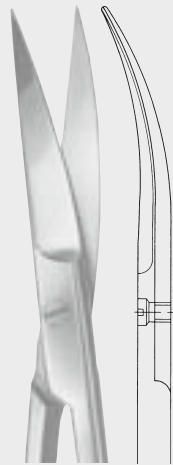

BC131R

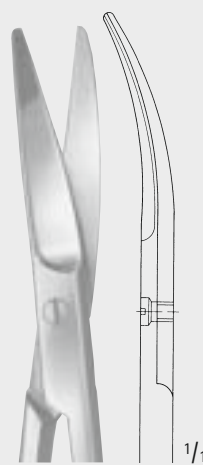

BC135R

BC130R-BC135R

120 mm, 4 3/4"

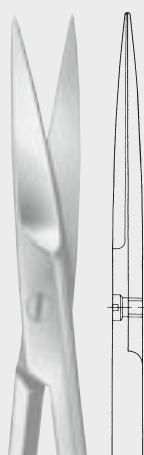

BC140R

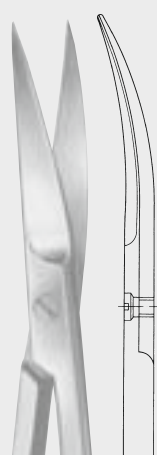

BC141R

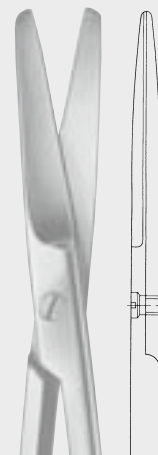

BC144R

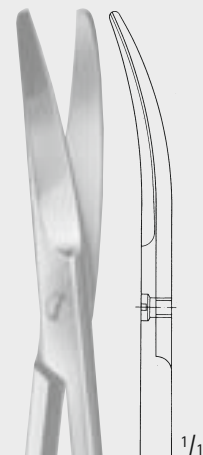

BC145R

BC140R-BC145R

130 mm, 5 1/8"

Scissors
Scheren

INCHES

Scissors – Scheren

Delicate Scissors

Feine Scheren

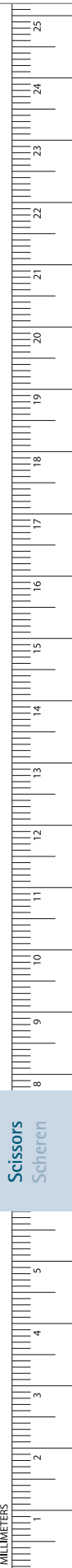
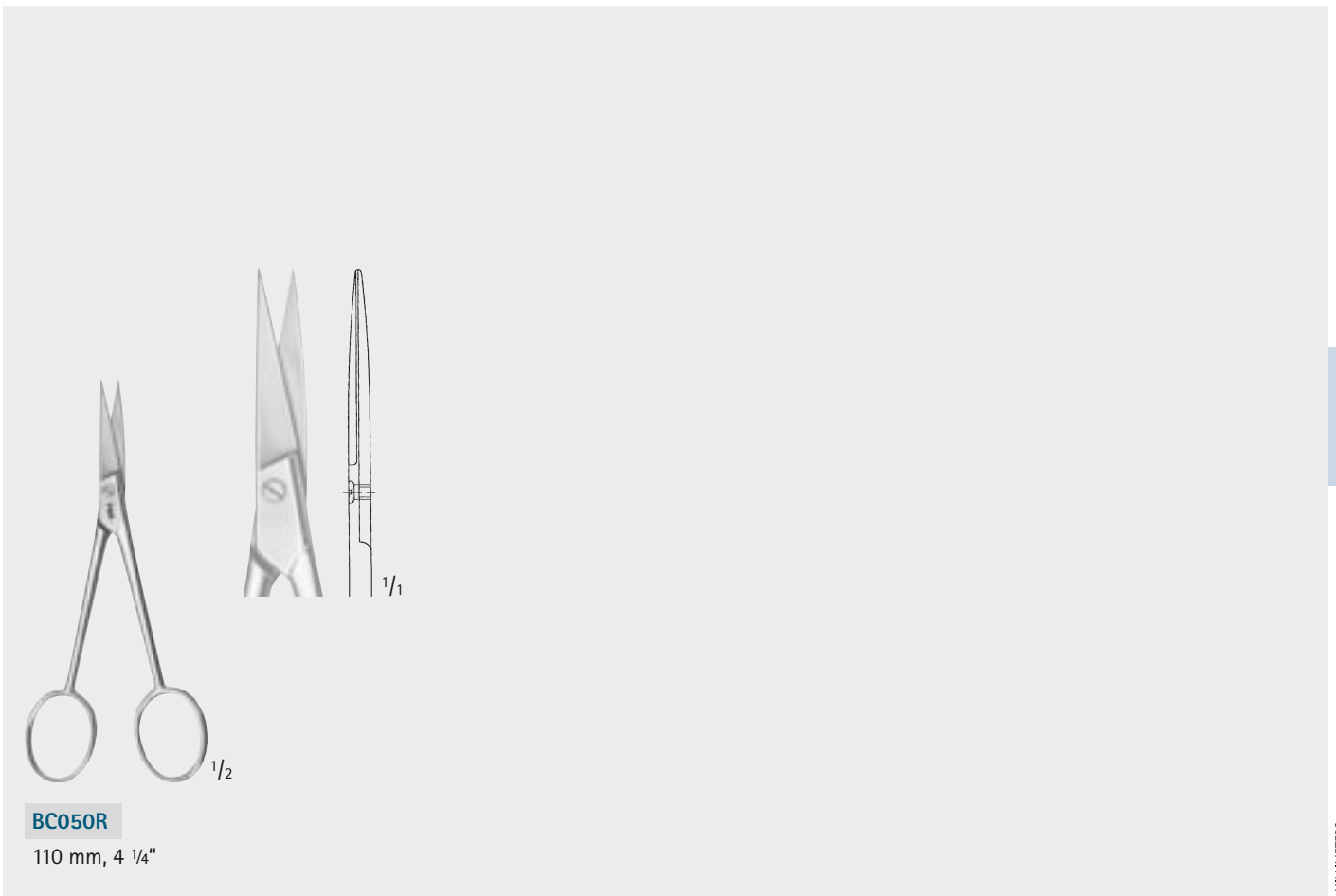
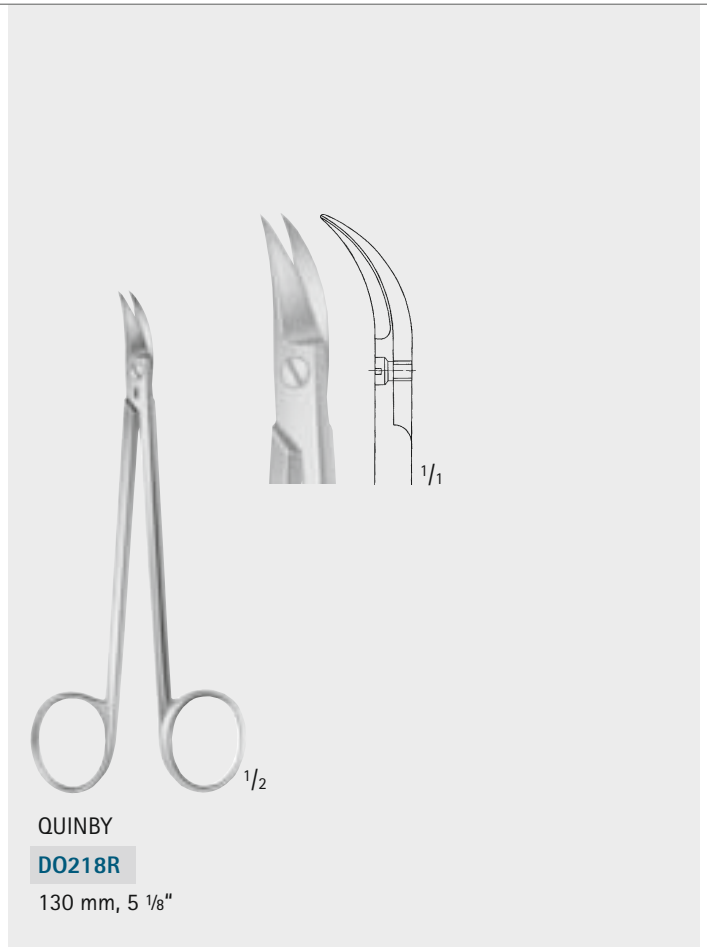

Scissors – Scheren

Delicate Scissors

Feine Scheren



curved to side
seitwärts gebogen

PERWITZSCHKY

OM489R

Salival scissors
Speichelgangschere
100 mm, 4"

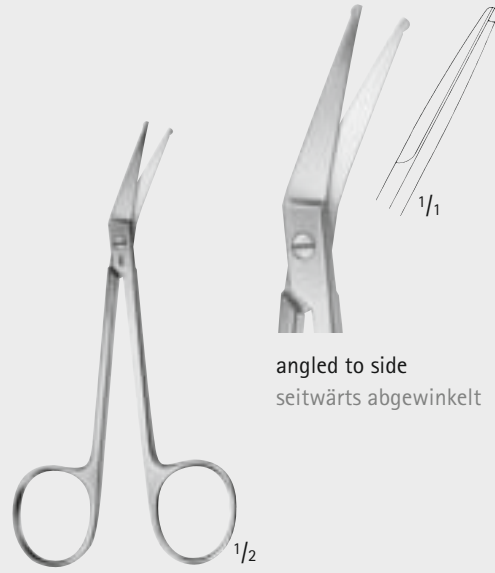

angled to side
seitwärts abgewinkelt

BC033R

115 mm, 4 1/2"

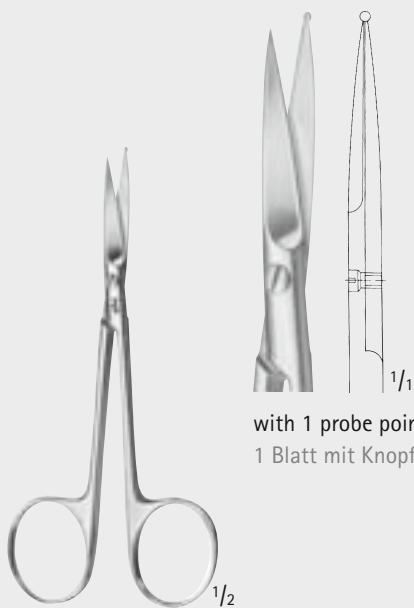

with 1 probe pointed blade
1 Blatt mit Knopf

BC030R

120 mm, 4 3/4"

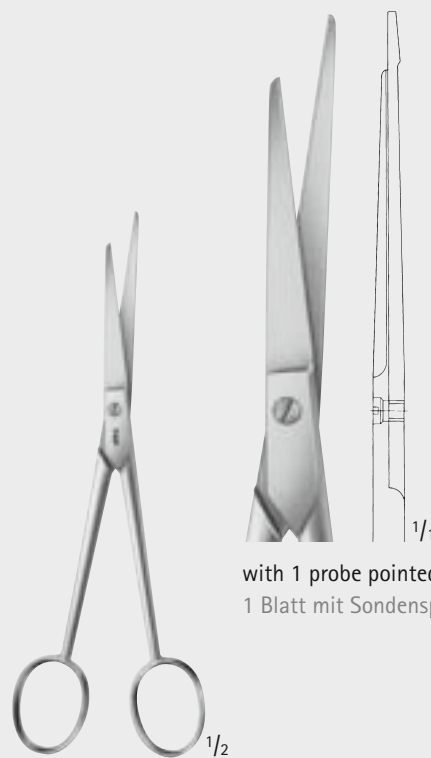

with 1 probe pointed blade
1 Blatt mit Sondenspitze

BC034R

145 mm, 5 3/4"

Scissors – Scheren

Delicate Scissors

Feine Scheren



1 blade serrated
1 Schneide gezahnt

LA GRANGE
BC154R
110 mm, 4 1/4"

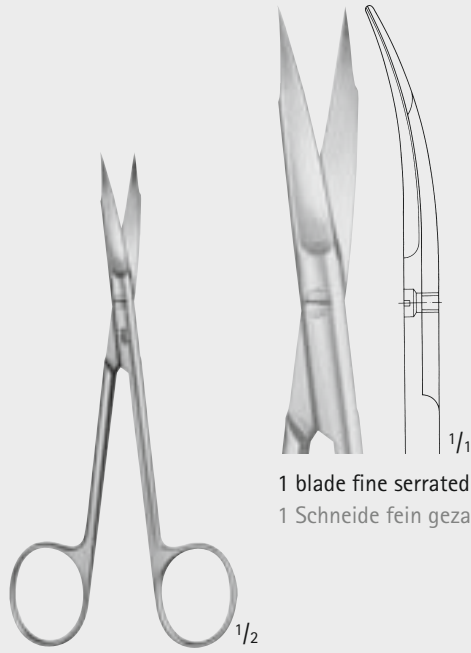

1 blade fine serrated
1 Schneide fein gezahnt

DO251R
130 mm, 5 1/8"



angled to side,
1 blade serrated
seitwärts abgewinkelt,
1 Schneide gezahnt

LOCKLIN
DO219R
155 mm, 6 1/8"

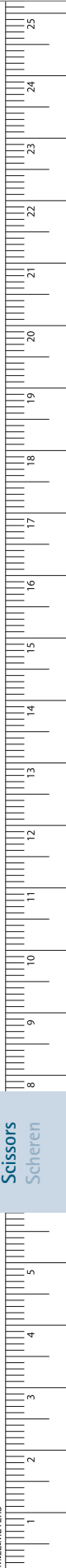

Scissors - Scheren

Delicate Scissors

Feine Scheren

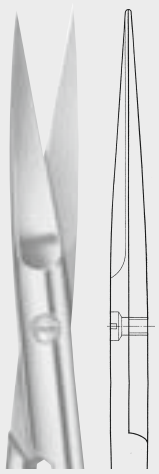

BC156R

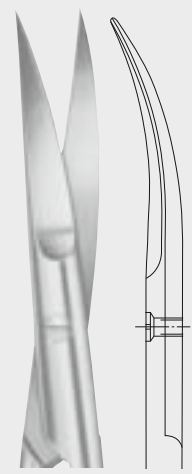

BC157R

1/1

1/2

JOSEPH

BC156R-BC157R

150 mm, 6"

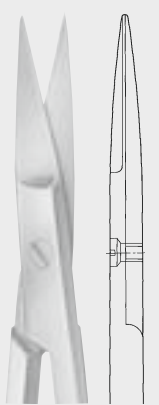

BC160R

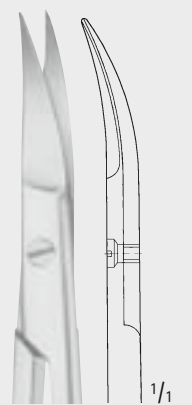

BC161R

1/1

1/2

KELLY

BC160R-BC161R

175 mm, 6 7/8"



1 blade serrated
1 Schneide gezahnt

1/1

1/2

MORSE

BC196R

175 mm, 6 7/8"

Scissors
Scheren

INCHES

Scissors – Scheren

Surgical Scissors

Chirurgische Scheren

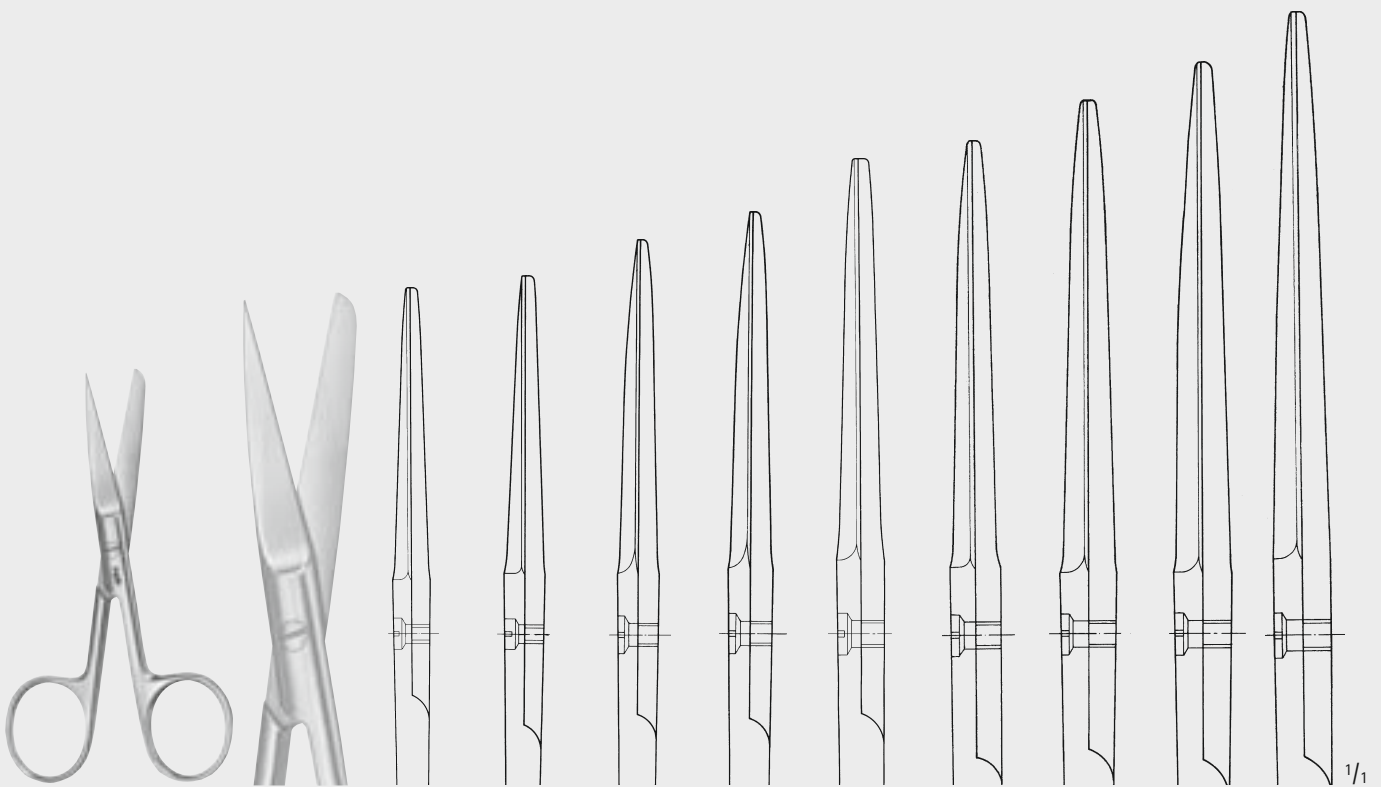

BC320R-BC330R
Standard patterns
Standard-Modelle

BC320R	BC321R	BC323R	BC324R	BC325R	BC326R	BC327R	BC328R	BC330R
105 mm	115 mm	130 mm	145 mm	150 mm	165 mm	175 mm	185 mm	200 mm
4 1/8"	4 1/2"	5 1/8"	5 3/4"	6"	6 1/2"	6 7/8"	7 1/4"	7 7/8"

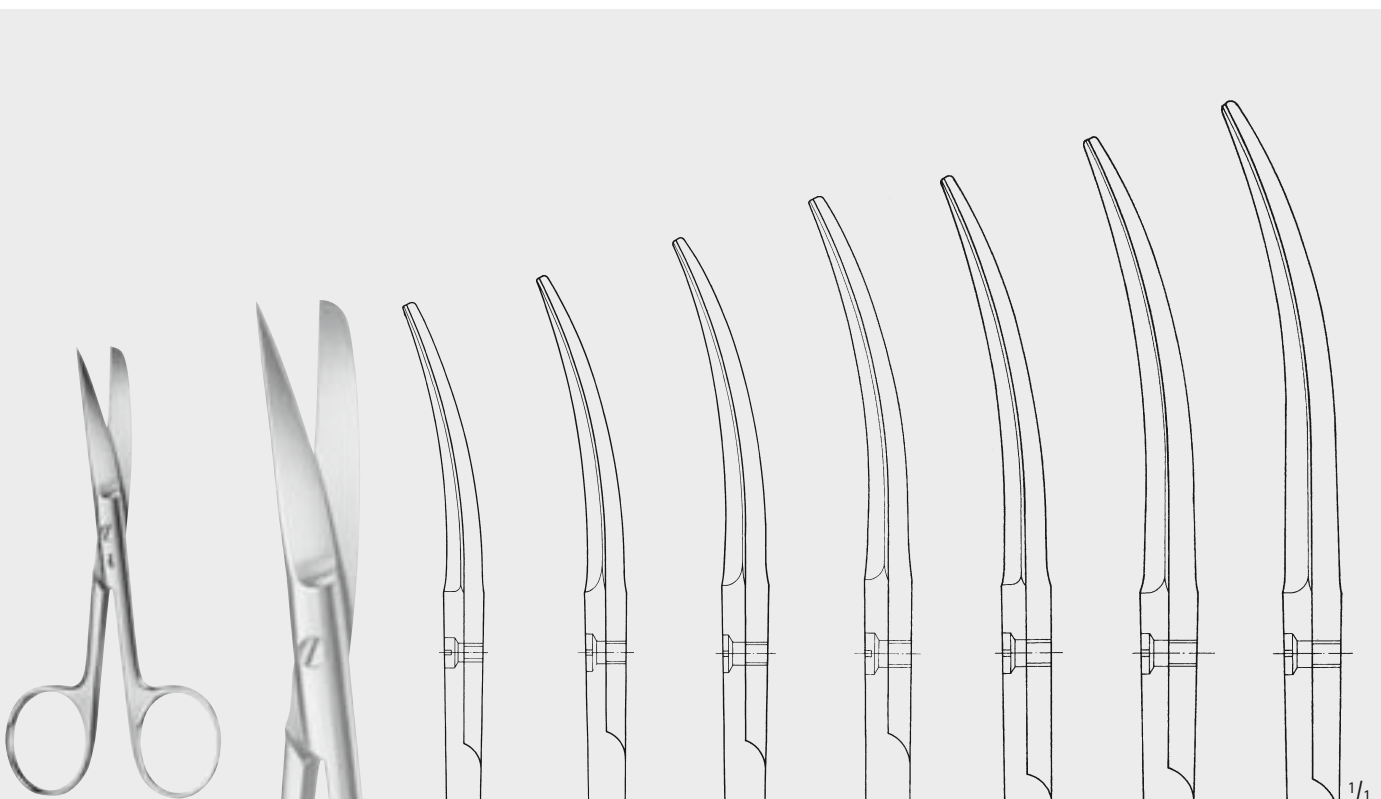

BC421R-BC428R
Standard patterns
Standard-Modelle

BC421R	BC423R	BC424R	BC425R	BC426R	BC427R	BC428R
115 mm	130 mm	145 mm	150 mm	165 mm	175 mm	185 mm
4 1/2"	5 1/8"	5 3/4"	6"	6 1/2"	6 7/8"	7 1/4"

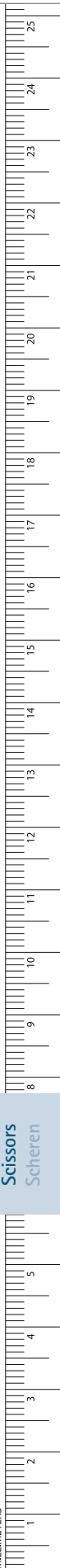

Scissors - Scheren

Surgical Scissors

Chirurgische Scheren



BC303R-BC304R
slender patterns
schlanke Modelle

BC303R	BC304R
130 mm	145 mm
5 1/8"	5 3/4"

BC496R
Scissors for wound edges
Wundrandschere
130 mm, 5 1/8"

1 blade serrated
1 Blatt gezahnt

BC403R-BC404R
slender patterns
schlanke Modelle

BC403R	BC404R
130 mm	145 mm
5 1/8"	5 3/4"

BC497R
130 mm, 5 1/8"

1 blade serrated
1 Blatt gezahnt

Scissors – Scheren

Surgical Scissors

Chirurgische Scheren



COOPER

BC313R-BC317R

Standard patterns
Standard-Modelle



BC313R

130 mm
5 1/8"

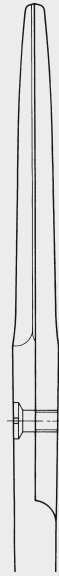

BC314R

145 mm
5 3/4"

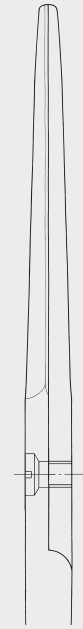

BC315R

150 mm
6"



BC316R

165 mm
6 1/2"



BC317R

175 mm
6 7/8"



COOPER

BC411R-BC417R

Standard patterns
Standard-Modelle



BC411R

115 mm
4 1/2"



BC413R

130 mm
5 1/8"



BC414R

145 mm
5 3/4"



BC415R

150 mm
6"



BC416R

165 mm
6 1/2"

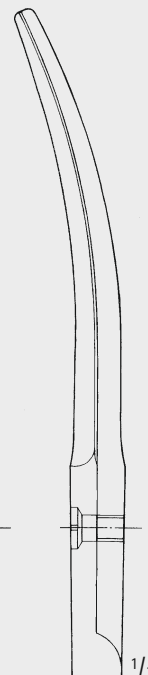

BC417R

175 mm
6 7/8"

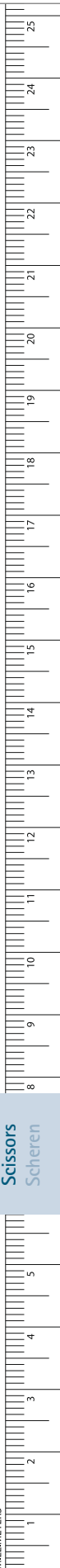

Scissors
Scheren

Scissors – Scheren

Surgical Scissors

Chirurgische Scheren

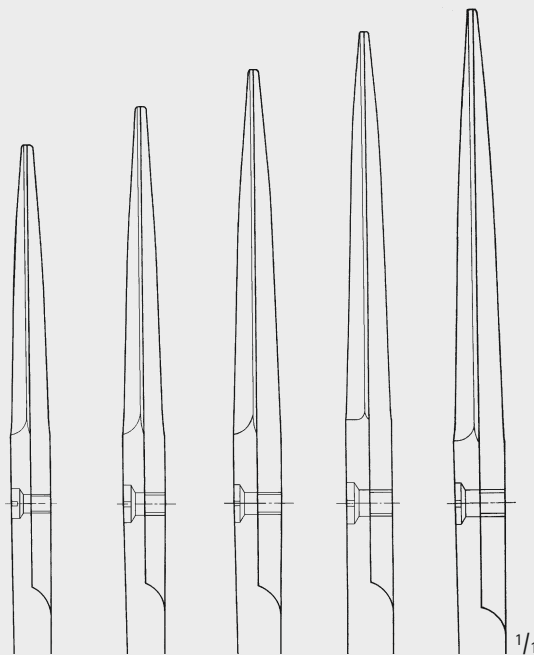

BC341R-BC346R

Standard patterns
Standard-Modelle

BC341R	BC343R	BC344R	BC345R	BC346R
115 mm	130 mm	145 mm	150 mm	165 mm
4 1/2"	5 1/8"	5 3/4"	6"	6 1/2"

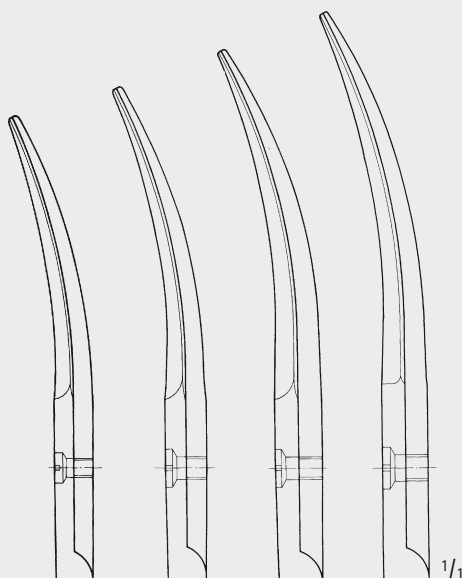

BC441R-BC445R

Standard patterns
Standard-Modelle

BC441R	BC443R	BC444R	BC445R
115 mm	130 mm	145 mm	150 mm
4 1/2"	5 1/8"	5 3/4"	6"

Scissors – Scheren

Surgical Scissors

Chirurgische Scheren



DEAVER

BC374R-BC464R

145 mm, 5 3/4"

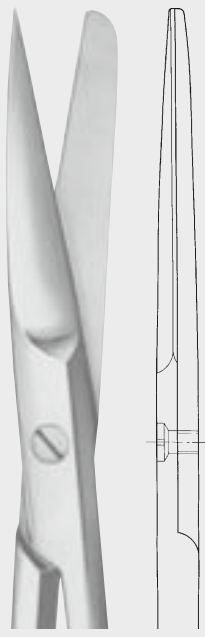

BC374R

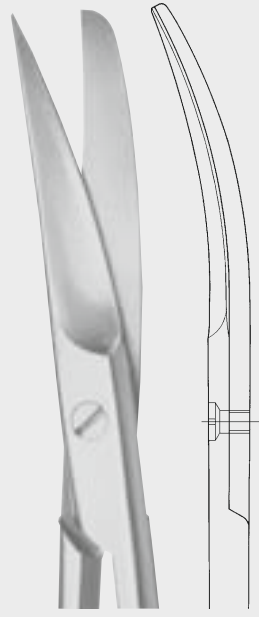

BC474R

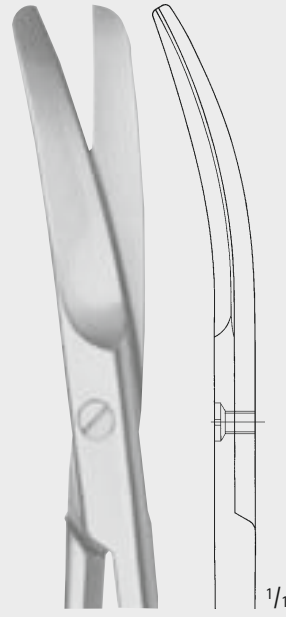

BC464R



BC503R-BC506R

Incision scissors
Inzisions-Scheren

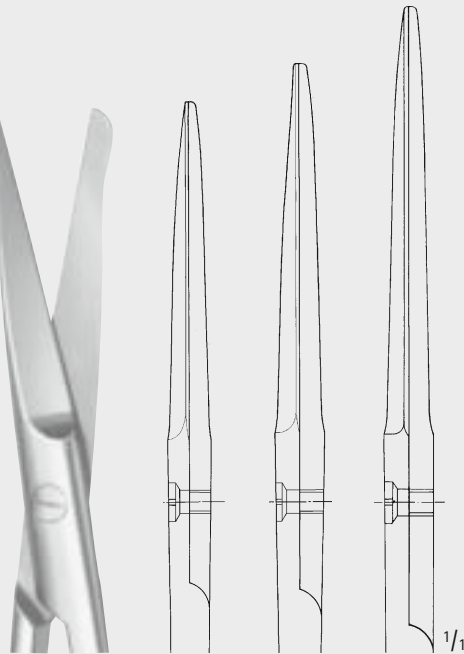

BC503R

130 mm
5 1/8"

BC504R

145 mm
5 3/4"

BC506R

165 mm
6 1/2"

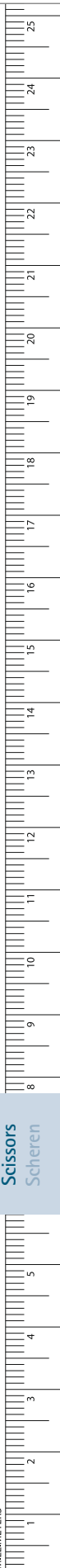

Scissors
Scheren

MILLIMETERS

Scissors – Scheren

Dissecting Scissors, Delicate Patterns

Präparierscheren, feine Modelle



GRAEFE
OC415R
100 mm, 4"

BC058R
105 mm, 4 1/8"

BC164R **BC165R**

BC164R-BC165R
115 mm, 4 1/2"

tips with eye for suture
mit Fadenbohrung in der Spitze

LITTLER
BC163R
115 mm, 4 1/2"

COTTLE
OK374R
115 mm, 4 1/2"

KILNER
BC162R
115 mm, 4 1/2"

Scissors – Scheren

Dissecting Scissors, Delicate Patterns

Präparierscheren, feine Modelle

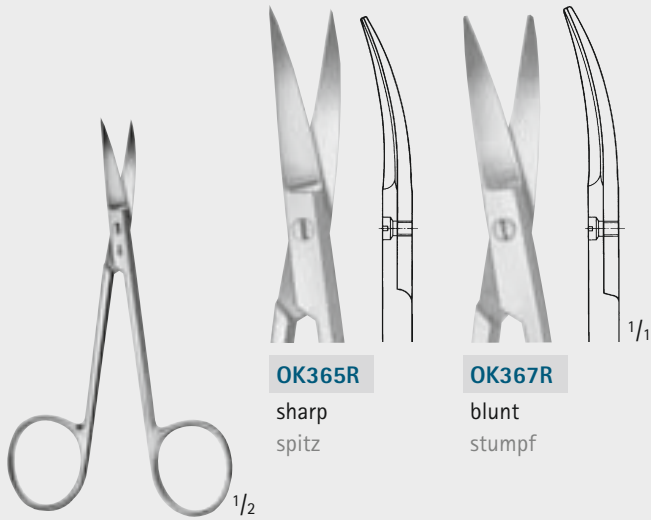

OK365R

sharp
spitz

OK367R

blunt
stumpf

COTTLE-MASING

OK365R-OK367R

Scissors for plastic surgery

Scheren für die plastische Chirurgie

105 mm, 4 1/8"

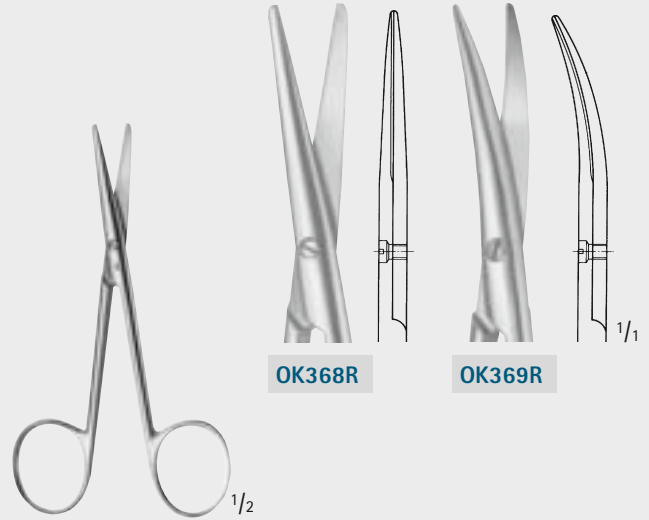

OK368R

OK369R

COTTLE-KNAPP

OK368R-OK369R

Scissors for plastic surgery

Scheren für die plastische Chirurgie

105 mm, 4 1/8"



OK372R

135 mm
5 1/4"

OK373R

115 mm
4 1/2"

FOMON

OK372R-OK373R

Lower lateral scissors

Nasenflügelscheren

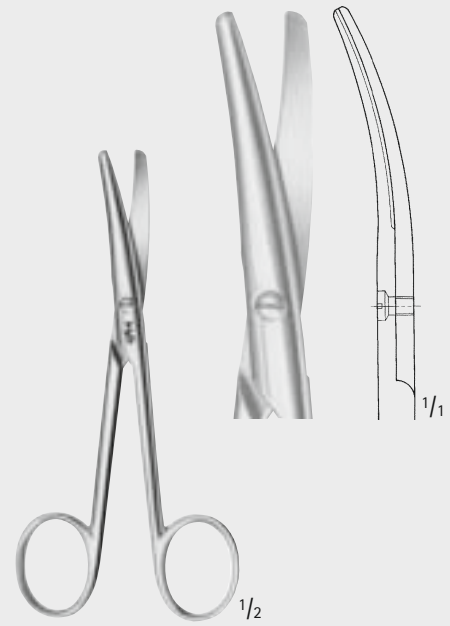

LANDOLT

OC430R

Enucleation scissors

Enukleationsschere

125 mm, 5"

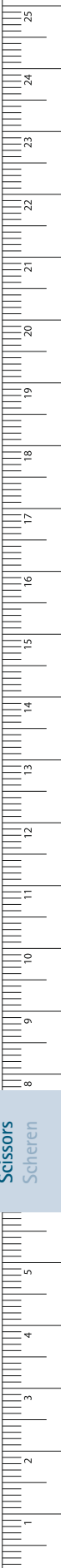

MILLIMETERS

Scissors – Scheren

Dissecting Scissors, Delicate Patterns

Präparierscheren, feine Modelle



1/2

STEVENS
BC186R-BC187R
100 mm, 4"

BC186R

BC187R

1/1

1/2

STEVENS
OK366R
110 mm, 4 1/4"

grazil

1/1

1/1

STEVENS
BC170R-BC195R

BC170R sharp spitz 110 mm 4 1/4"	BC171R sharp spitz 110 mm 4 1/4"	BC172R blunt stumpf 110 mm 4 1/4"	BC173R blunt stumpf 110 mm 4 1/4"	BC194R blunt stumpf 125 mm 5"	BC195R blunt stumpf 125 mm 5"
---	---	--	--	--	--

Scissors – Scheren

Dissecting Scissors, Delicate Patterns

Präparierscheren, feine Modelle

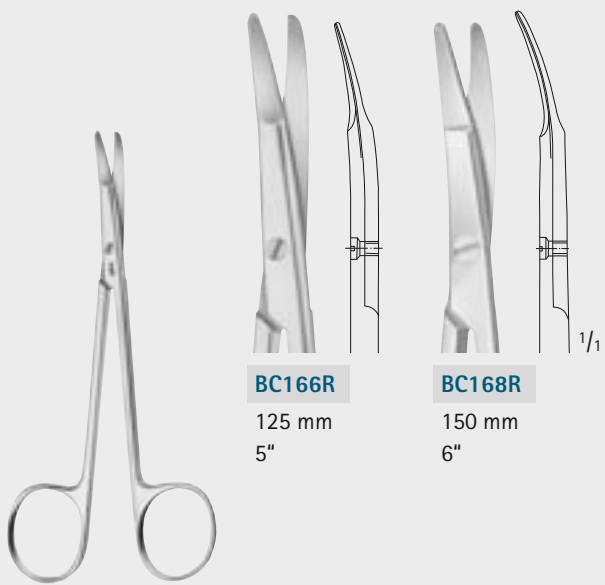

BC166R
125 mm
5"

BC168R
150 mm
6"

KILNER
BC166R-BC168R
special flat points for dissecting and undermining the skin
besonders flache Spitzen zum Präparieren und Unterminieren der Haut

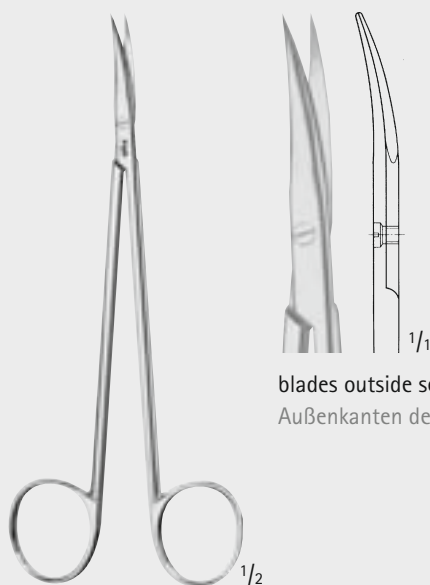

blades outside semi-sharp
Außenkanten der Blätter halbscharf

BC628R
Nerve dissecting scissors
Nerv-Präparierschere
150 mm, 6"

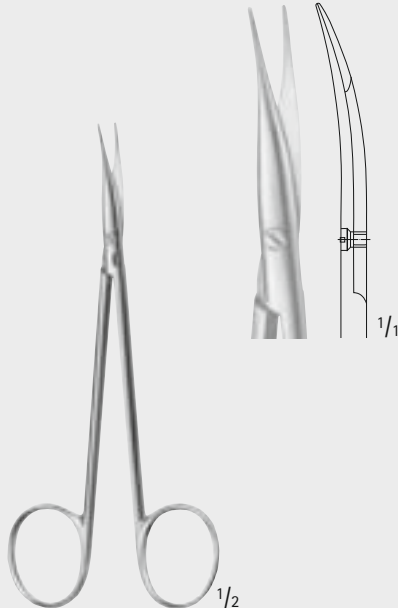

BC175R
130 mm, 5 1/8"

JAMESON-WERBER

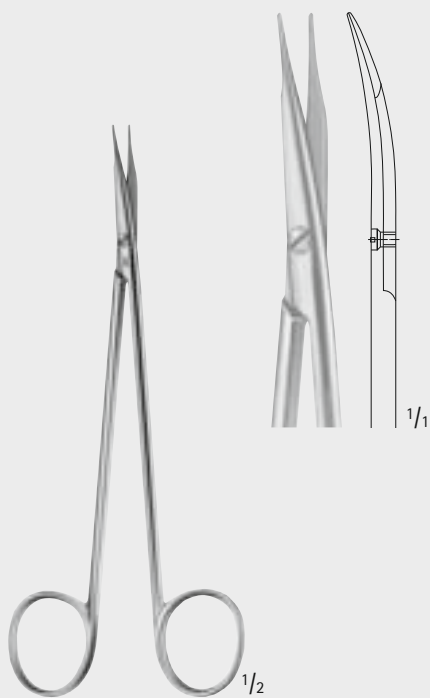

BC177R
150 mm, 6"

JAMESON

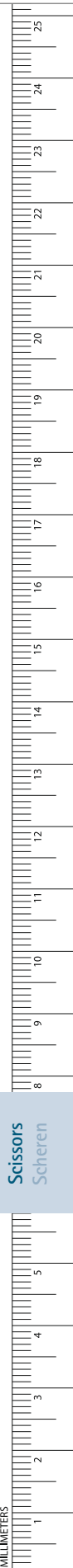

Scissors – Scheren

Dissecting Scissors, Delicate Patterns

Präparierscheren, feine Modelle

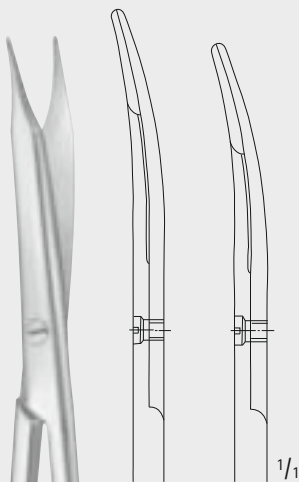

BC180R 145 mm 5 3/4"
BC181R 175 mm 6 7/8"

REYNOLDS

BC180R-BC181R

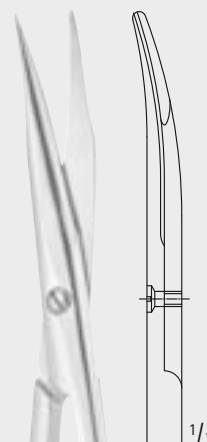

POTTS

BC178R

175 mm, 6 7/8"

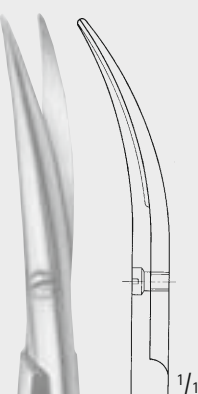

DE BAKEY

BC629R

175 mm, 6 7/8"

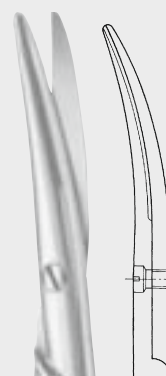

BC630R

very delicate
sehr fein

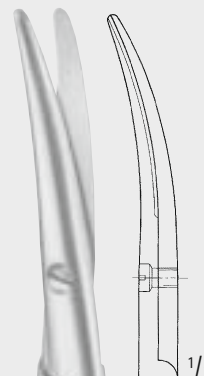

BC631R

delicate
fein

TÖNNIS-ADSON

BC630R-BC631R

175 mm, 6 7/8"

Scissors
Scheren

INCHES

Scissors – Scheren
 Dissecting Scissors
 Präparierscheren



TÖNNIS

BC633R-BC635R

180 mm, 7"



BC633R

very delicate
sehr fein

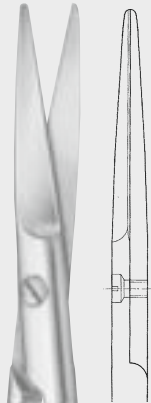

BC634R

delicate
fein

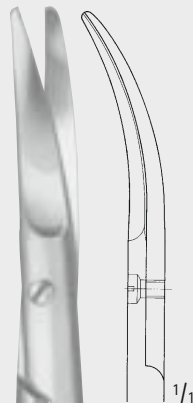

BC635R

delicate
fein



GORNEY

BC184R-BC189R

for plastic surgery

Blades: outside semi-sharp, inside fine serrated

für plastische Chirurgie

Schneiden: außen halbscharf, innen fein gezahnt

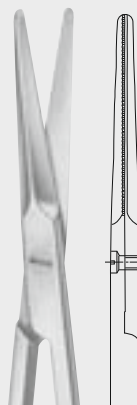

BC184R

125 mm
5"

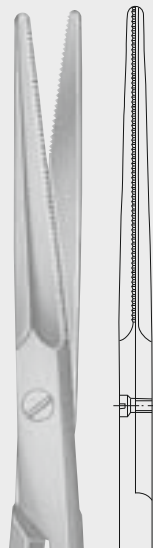

BC188R

195 mm
7 3/4"

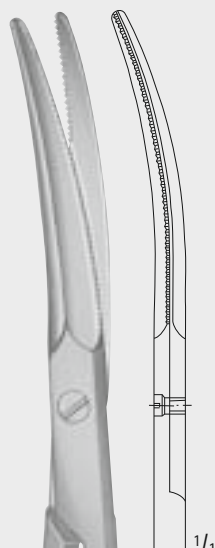

BC189R

195 mm
7 3/4"

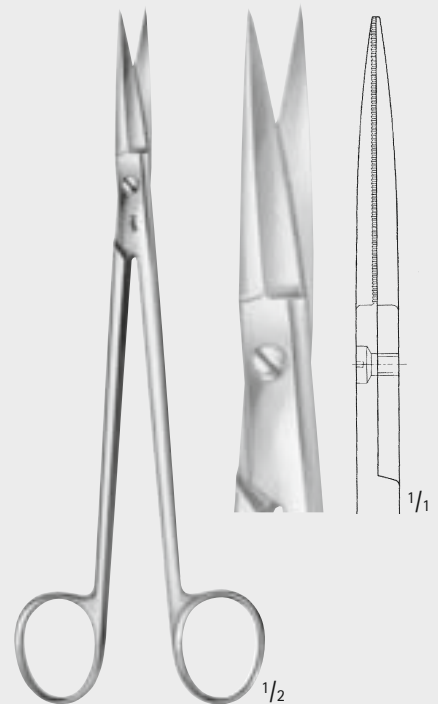

BC672R

Cartilage scissors,

blades cutting on both sides

Knorpelschere,

Blätter außen und innen schneidend

185 mm, 7 1/4"

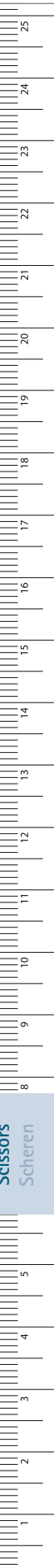

Scissors
Scheren

MILLIMETERS

Scissors - Scheren

Dissecting Scissors

Präparierscheren



MAYO

BC544R-BC557R



BC544R

140 mm
5 1/2"



BC545R

155 mm
6 1/8"



BC547R

170 mm
6 3/4"



BC554R

140 mm
5 1/2"



BC555R

155 mm
6 1/8"



BC557R

170 mm
6 3/4"



1/1



MAYO-STILLE

BC570R-BC575R



BC570R

140 mm
5 1/2"



BC572R

170 mm
6 3/4"



BC573R

140 mm
5 1/2"



BC575R

170 mm
6 3/4"



1/1

Scissors
Scheren

INCHES

Scissors – Scheren
 Dissecting Scissors
 Präparierscheren



MAYO-STILLE

BC576R-BC579R

with chamfered blades
 mit abgeschrägten Schneiden

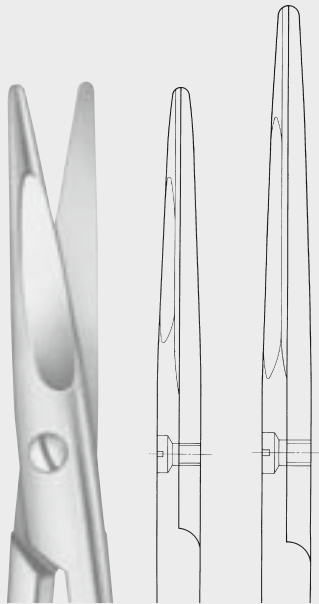

BC576R

BC578R

140 mm

165 mm

5 1/2"

6 1/2"

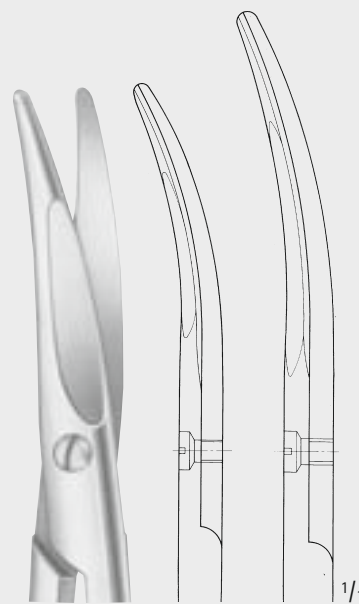

BC577R

BC579R

140 mm

165 mm

5 1/2"

6 1/2"



MAYO

BC562R-BC565R

with chamfered blades
 mit abgeschrägten Schneiden



BC562R

BC564R

190 mm

215 mm

7 1/2"

8 1/2"

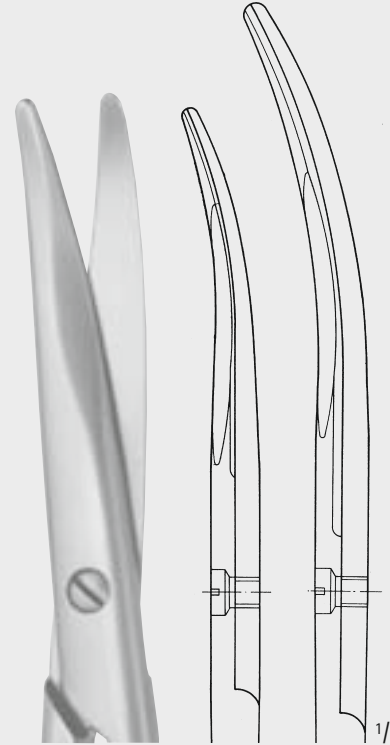

BC563R

BC565R

190 mm

215 mm

7 1/2"

8 1/2"

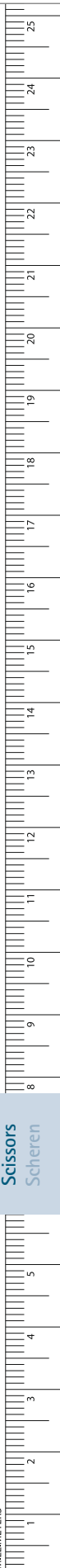

Scissors
 Scheren

MILLIMETERS

Scissors - Scheren

Dissecting Scissors

Präparierscheren

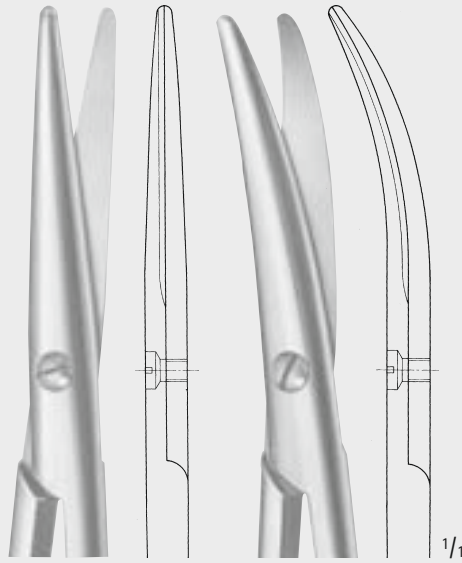

BC580R

BC581R

STILLE

BC580R-BC581R

150 mm, 6"

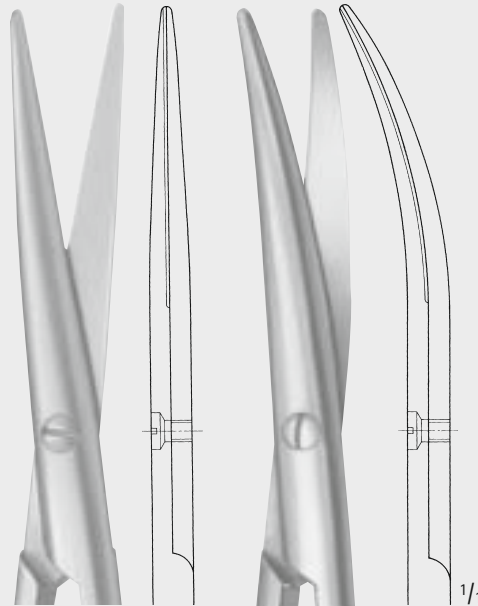

BC590R

BC591R

LEXER

BC590R-BC591R

narrow
schmal
165 mm, 6 1/2"

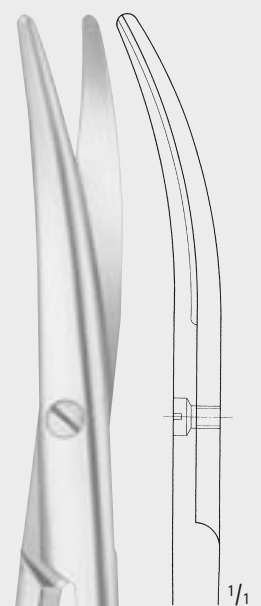
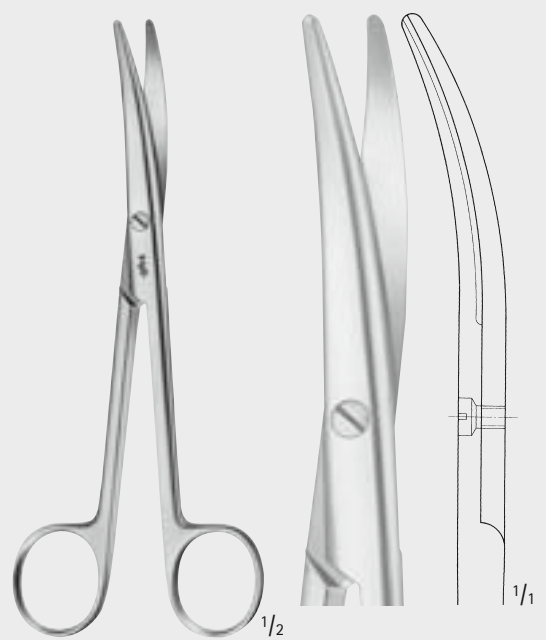

MAYO-LEXER

BC592R

Standard pattern
Standard-Modell
165 mm, 6 1/2"

Scissors – Scheren
 Dissecting Scissors
 Präparierscheren

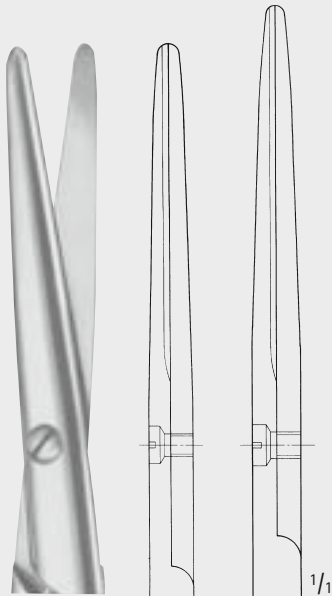

BC584R	BC585R
165 mm	200 mm
6 1/2"	7 7/8"

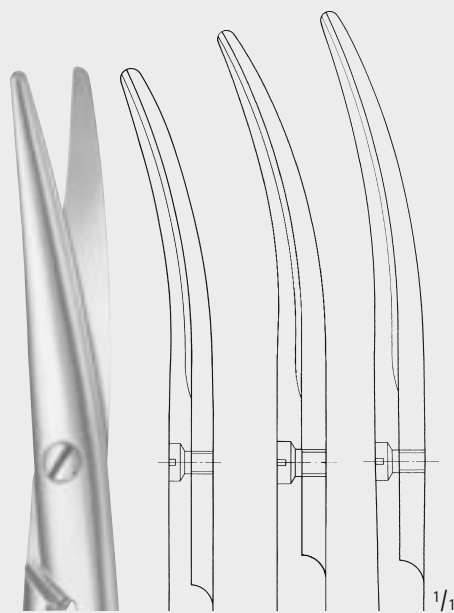

BC587R	BC588R	BC589R
165 mm	200 mm	210 mm
6 1/2"	7 7/8"	8 1/4"



MAYO
BC584R-BC589R

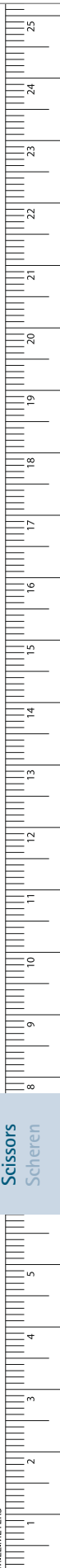

Scissors – Scheren

Dissecting Scissors

Präparierscheren

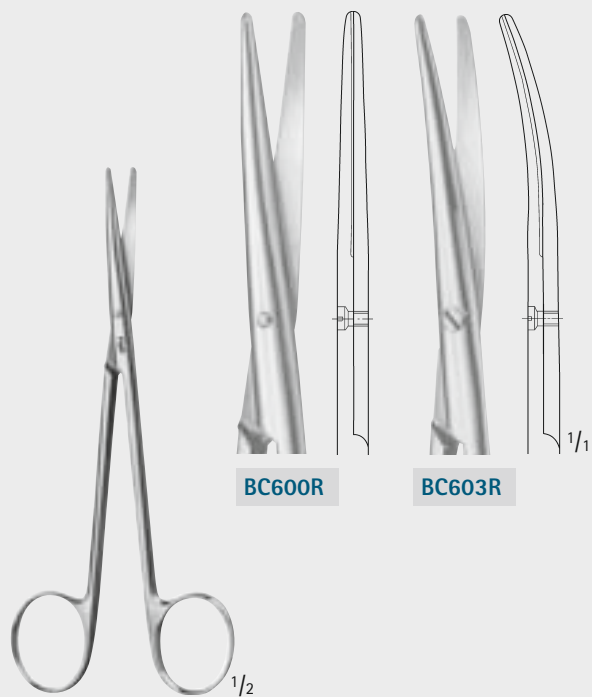

BC600R

BC603R

BABY-METZENBAUM

BC600R-BC603R

145 mm, 5 3/4"

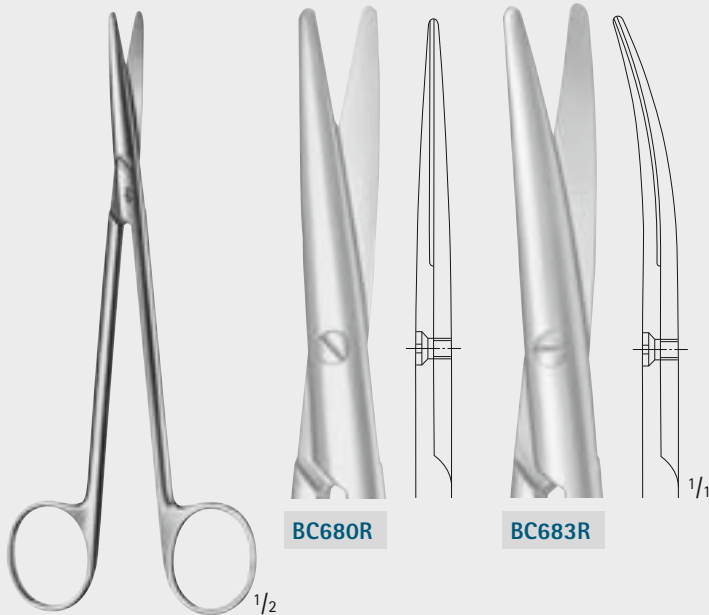

BC680R

BC683R

METZENBAUM

BC680R-BC683R

160 mm, 6 1/4"

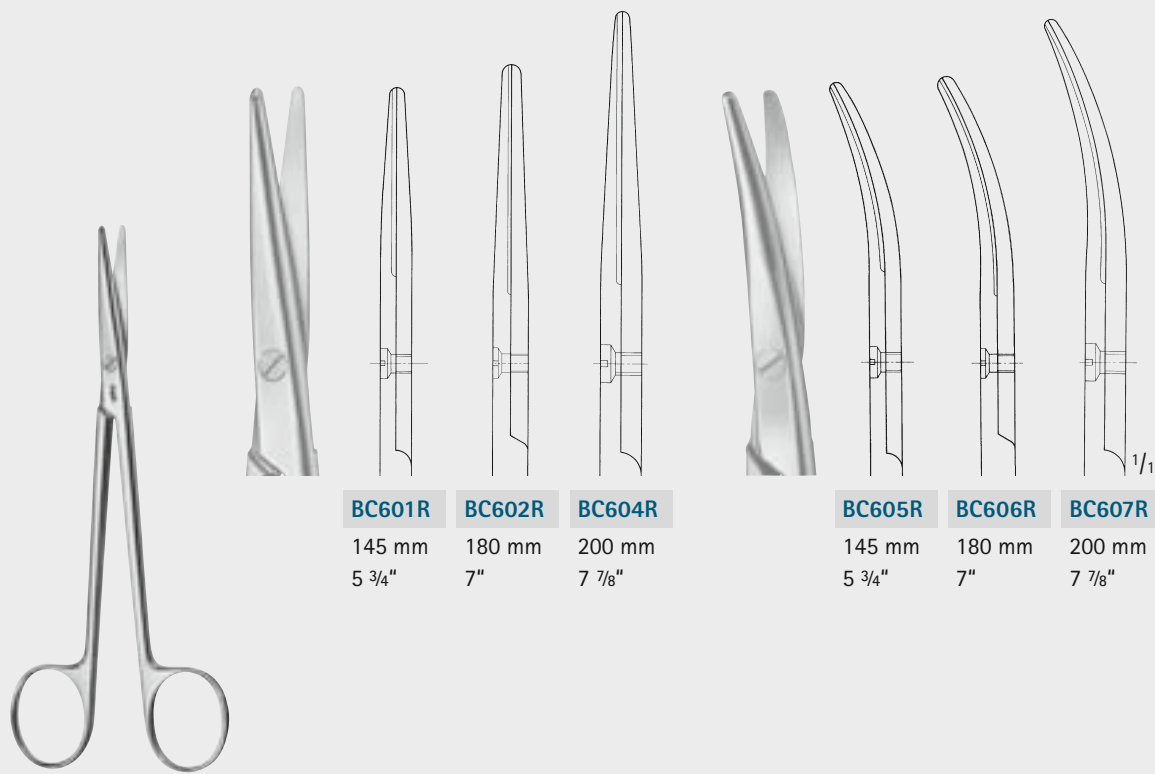

BC601R

BC602R

BC604R

145 mm
5 3/4"

180 mm
7"

200 mm
7 7/8"

BC605R

BC606R

BC607R

145 mm
5 3/4"

180 mm
7"

200 mm
7 7/8"

METZENBAUM

BC601R-BC607R

Scissors
Scheren

INCHES

Scissors – Scheren

Dissecting Scissors

Präparierscheren

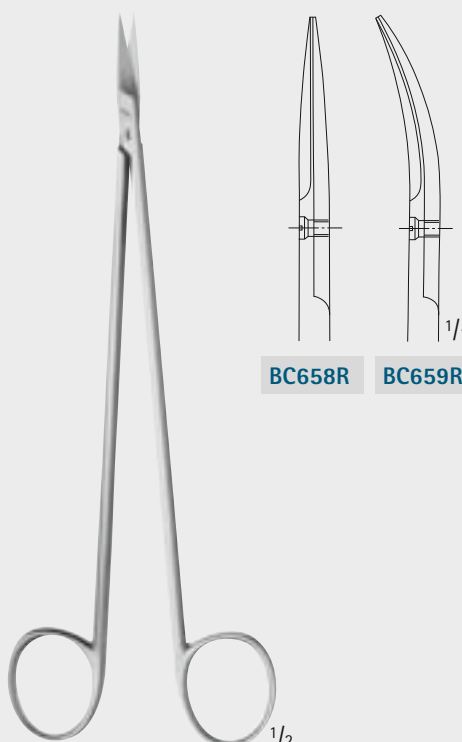

BC658R BC659R

BC658R-BC659R
 very delicate
 sehr fein
 195 mm, 7 3/4"

1/2 1/1

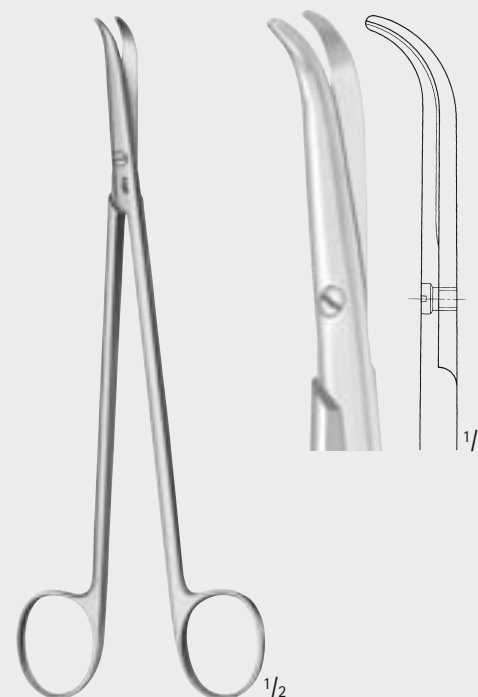

THOREK
 BC636R
 180 mm, 7"

1/2 1/1

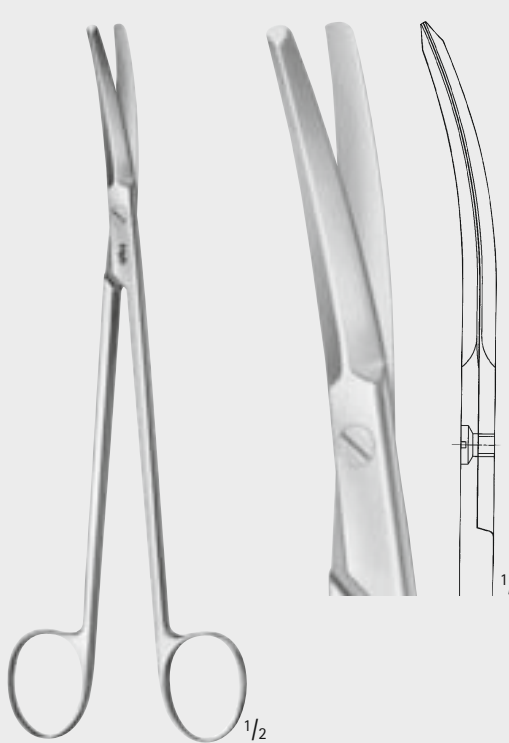

POTTS-SMITH
 BC643R
 190 mm, 7 1/2"

1/2 1/1



COOLEY
 BC597R
 190 mm, 7 1/2"

1/2 1/1

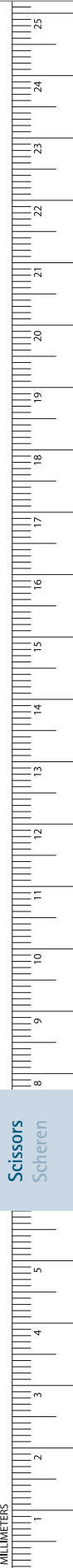

Scissors – Scheren

Ligature Scissors

Ligaturscheren



SPENCER

BC801R-BC803R



BC801R

90 mm
3 1/2"



BC802R

115 mm
4 1/2"



LITTAUER

BC803R

135 mm, 5 1/4"



NORTHBENT

BC805R

120 mm, 4 3/4"

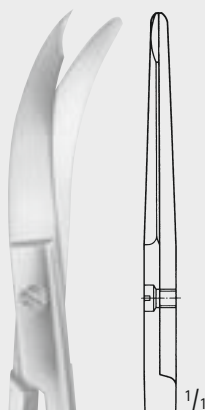

Scissors
Scheren

INCHES

Scissors – Scheren

Bandage- and Cloth Scissors

Verband- und Kleiderscheren



LISTER

Art. No. Art. Nr.	Handle color Grifffarbe
BC885R	black schwarz
BC970R	red rot
BC971R	blue blau
BC973R	yellow gelb
BC975R	orange orange
BC977R	pink pink
BC978R	light green hellgrün
BC979R	violet violett

Universal bandage and cloth scissors,
with toothed edges,
autoclavable up to 143 °C (3 bar)
Universal Verband- und Kleiderstoffschere,
mit gezahnten Schneiden,
autoklavierbar bis 143 °C (3 bar)
145 mm, 5 3/4"



Art. No. Art. Nr.	Handle color Grifffarbe
BC881R	black schwarz
BC980R	red rot
BC981R	blue blau
BC983R	yellow gelb
BC985R	orange orange
BC987R	pink pink
BC988R	light green hellgrün
BC989R	violet violett

Universal bandage and cloth scissors,
with toothed edges,
autoclavable up to 143 °C (3 bar)
Universal Verband- und Kleiderstoffschere,
mit gezahnten Schneiden,
autoklavierbar bis 143 °C (3 bar)
180 mm, 7"

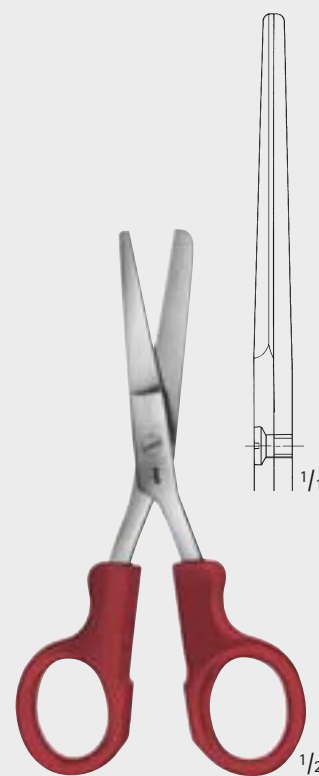

BC890R

Nurse's scissors,
autoclavable up to 143 °C (3 bar)
Schwesternschere,
autoklavierbar bis 143 °C (3 bar)
145 mm, 5 3/4"

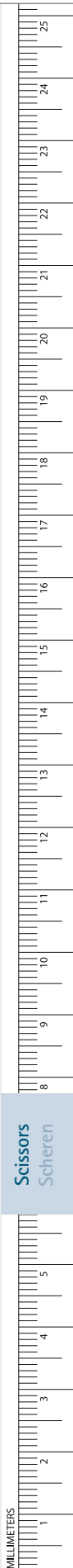

Scissors – Scheren

Bandage- and Cloth Scissors

Verband- und Kleiderscheren

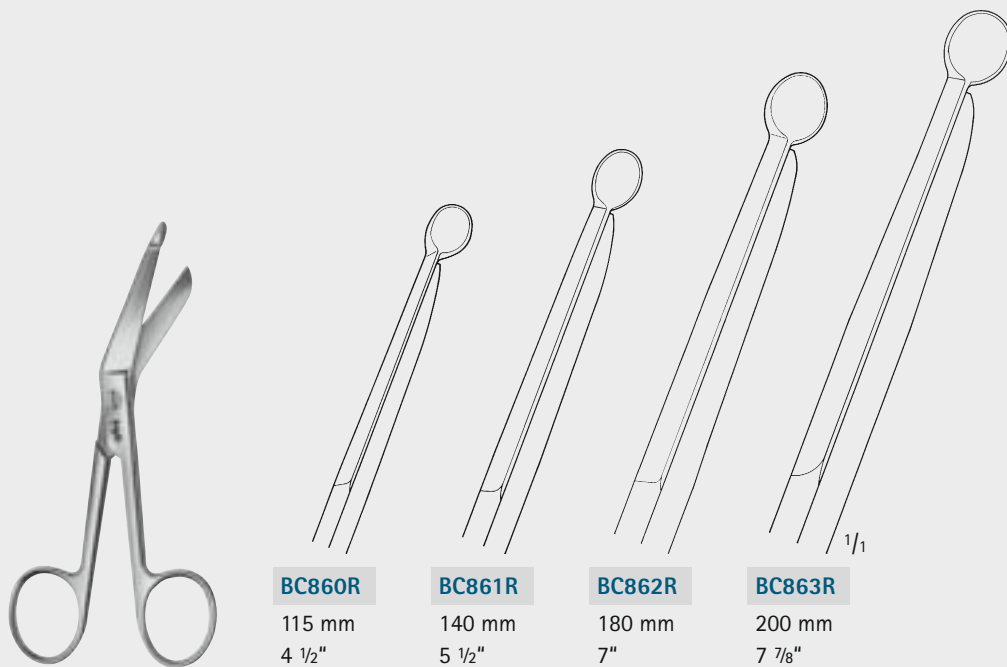

BC860R

115 mm
4 1/2"

BC861R

140 mm
5 1/2"

BC862R

180 mm
7"

BC863R

200 mm
7 7/8"

LISTER

BC860R-BC863R

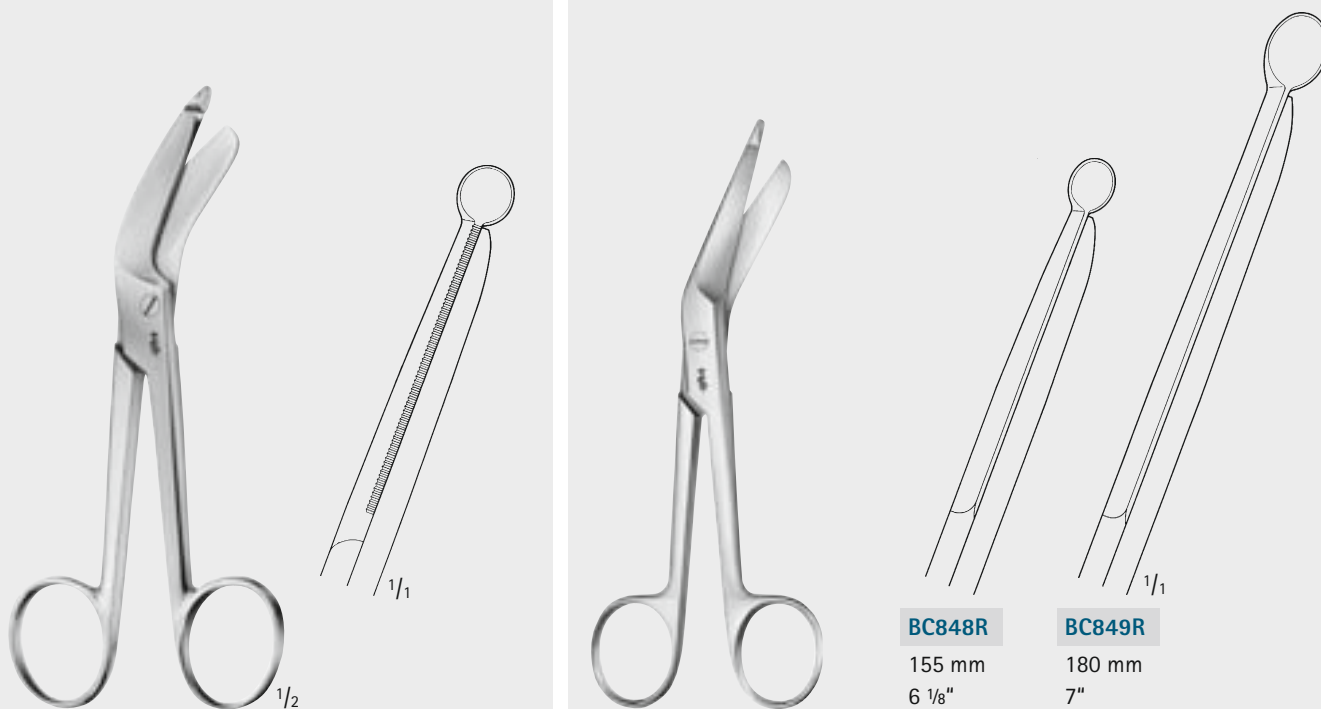

LISTER

BC876R

160 mm, 6 1/4"

LISTER

BC848R-BC849R

BC848R

155 mm
6 1/8"

BC849R

180 mm
7"

General Surgical Instruments Chirurgische Instrumente

- Dissecting- and Tissue Forceps
- Pinzetten

Forceps – Pinzetten

Delicate Forceps

Feine Pinzetten



- Titanium
- Titan

1 mm

1/1

1/2

MICRO-ADSON
BD221T
Dissecting forceps
Anatomische Pinzette
120 mm, 4 3/4"

- Titanium
- Titan

1 mm

1/1

1/2

MICRO-ADSON
BD514T
Tissue forceps
Chirurgische Pinzette
120 mm, 4 3/4"

- Titanium
- Titan

1.5 mm

1/1

1/2

MICRO-ADSON
BD516T
Tissue forceps
Chirurgische Pinzette
120 mm, 4 3/4"

- ERGOPLANT

1/1

1/2

DX050R
Tissue forceps
Chirurgische Pinzette
120 mm, 4 3/4"

- ERGOPLANT

1/1

with plateau
mit Plateau

1/2

DX051R
Tissue forceps
Chirurgische Pinzette
120 mm, 4 3/4"

- ERGOPLANT

- DUROGRIP®
with tungsten carbide inserts
mit Hartmetalleinlagen

1/1

1/2

DX052R
Atraumatic forceps
Atraumatische Pinzette
120 mm, 4 3/4"

- ERGOPLANT

1/1

1/2

DX055R
Soft tissue forceps
Weichgewebepinzette
140 mm, 5 1/2"

Forceps – Pinzetten

Delicate Dissecting Forceps Feine anatomische Pinzetten

1/2

THORPE
OC069R
120 mm, 4 3/4"

1/2

MICRO-ADSON
BD220R
120 mm, 4 3/4"
with plateau
mit Plateau

1/2

ADSON
BD222R
120 mm, 4 3/4"

1/2

HUDSON
BD225R
125 mm, 5"

1/2

MICRO-ADSON
BD223R
150 mm, 6"

1/2

ADSON
BD224R
180 mm, 7"

1/2

JEFFERSON
BD226R
180 mm, 7"

1/2

OC020R **OC021R** **OC022R**
OC020R-OC022R
Iris forceps
Iris Pinzette
100 mm, 4"

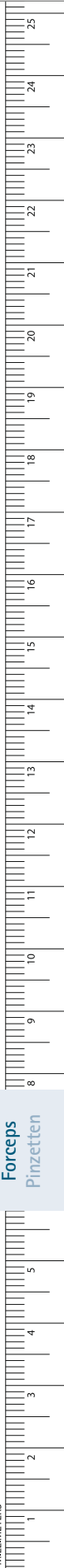

Forceps – Pinzetten

Delicate Dissecting Forceps

Feine anatomische Pinzetten

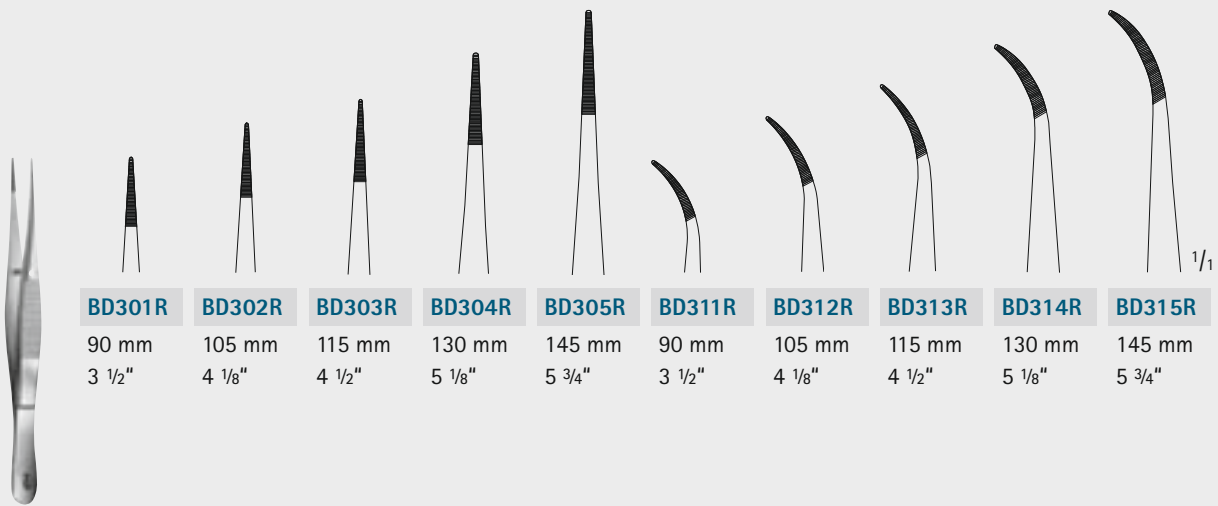

BD301R–BD315R

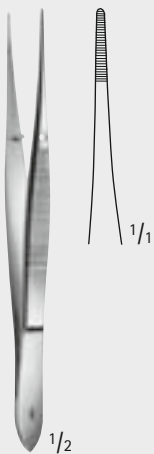

BD210R

115 mm, 4 1/2"



BD320R

100 mm, 4"

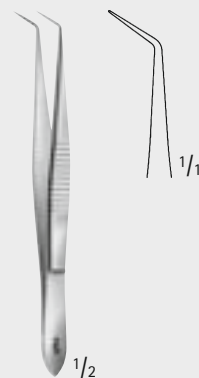

BD321R

100 mm, 4"

Forceps
Pinzetten

INCHES

Forceps – Pinzetten

Dissecting Forceps

Anatomische Pinzetten

BD215R 125 mm 5"
BD216R 150 mm 6"
SEMKEN
BD215R-BD216R

BD217R
 155 mm, 6 1/8"

GILLIES
BD213R
 150 mm, 6"

MC INDOE
BD236R
 150 mm, 6"

BD228R 175 mm 6 7/8"
BD229R 175 mm 6 7/8"
BD230R 230 mm 9"
GERALD
BD228R-BD230R

■ Titanium
 ■ Titan
 1.5 mm
GERALD
BD227T
 170 mm, 6 3/4"

■ Titanium
 ■ Titan
 1.5 mm
GERALD
BD657T
 170 mm, 6 3/4"

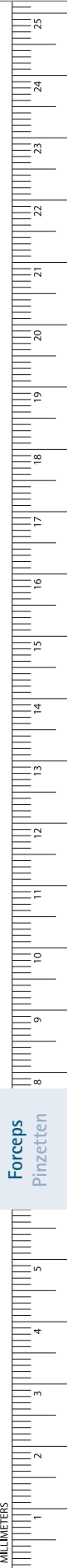

Forceps – Pinzetten

Dissecting Forceps

Anatomische Pinzetten



BD268R
175 mm
6 7/8"

BD269R
215 mm
8 1/2"

CAIRNS-DOTT
BD268R-BD269R

BD238R
180 mm
7"

BD239R
200 mm
7 7/8"

BD243R
200 mm
7 7/8"

CUSHING
BD238R-BD243R

BD246R

BD247R

BROPHY
BD246R-BD247R
200 mm, 7 7/8"

Forceps
Pinzetten

Forceps – Pinzetten

Dissecting Forceps

Anatomische Pinzetten

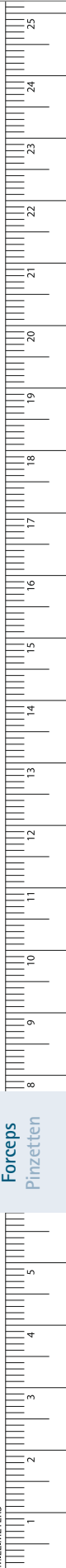
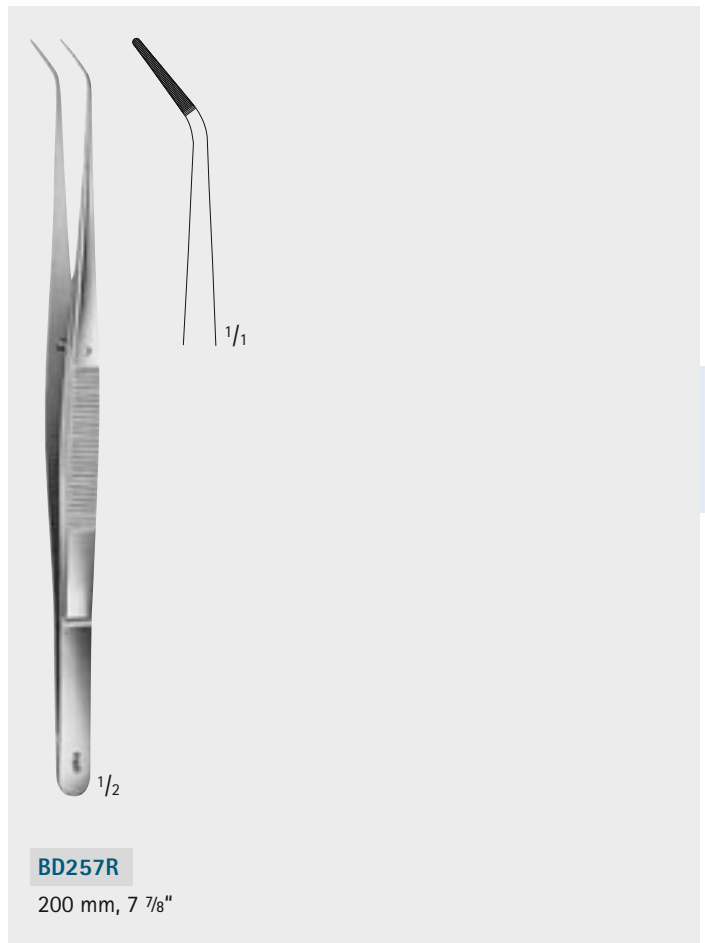
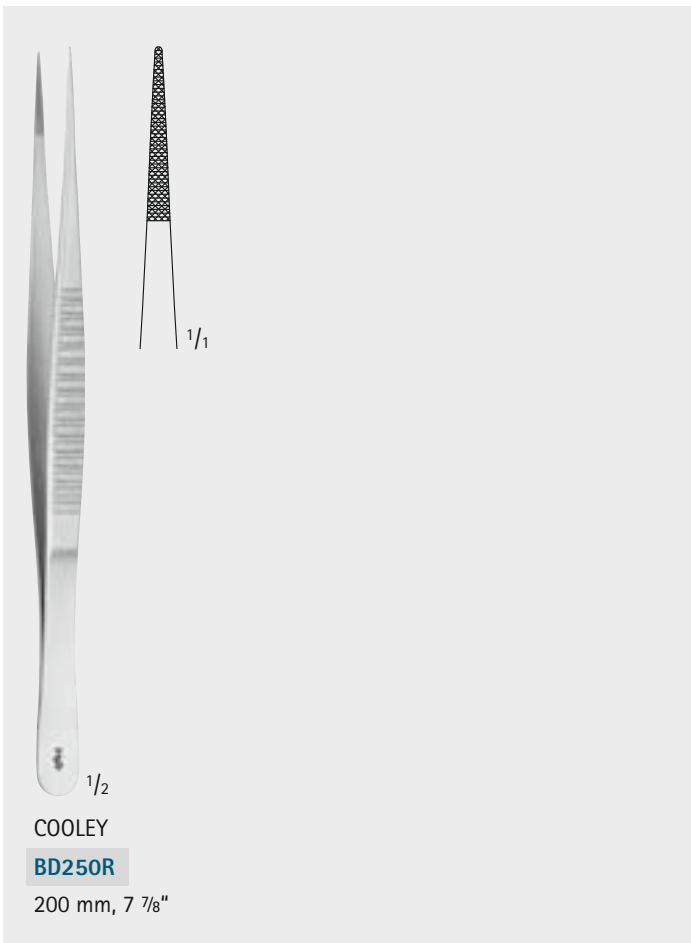
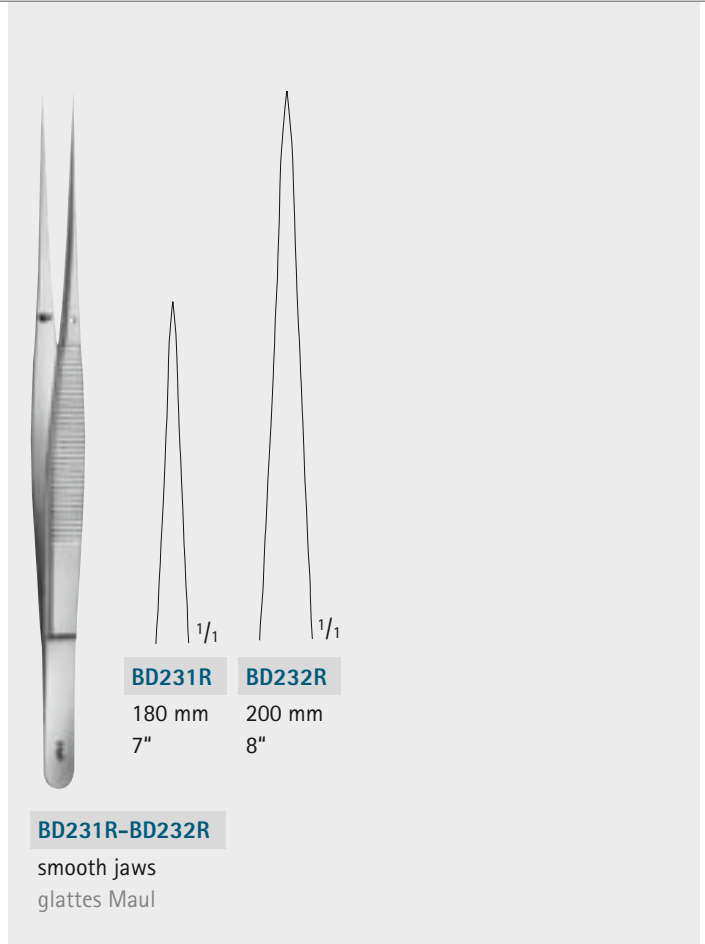
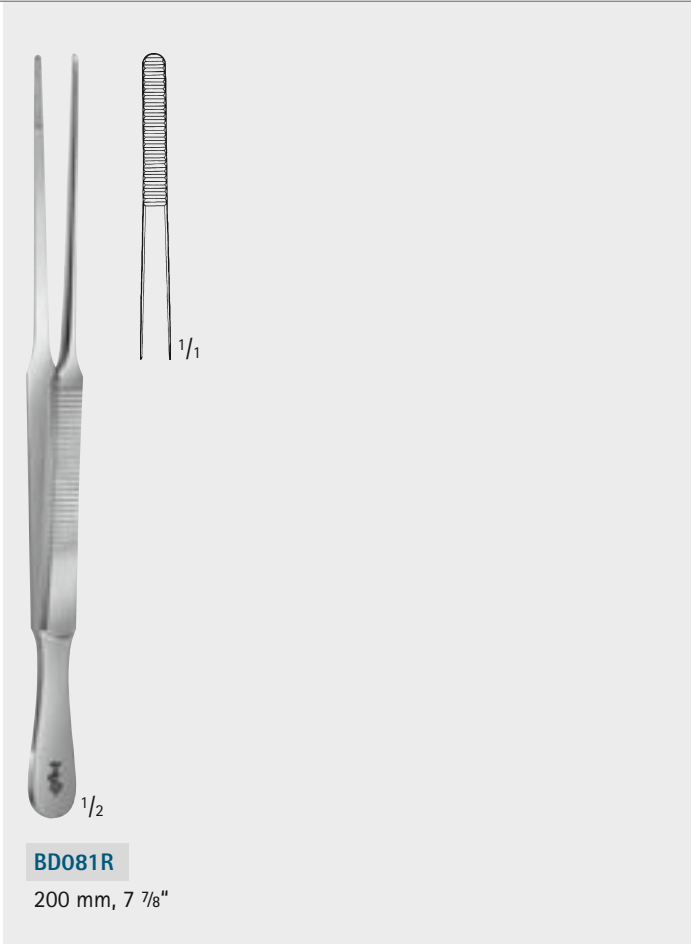

Forceps – Pinzetten

Dissecting Forceps

Anatomische Pinzetten

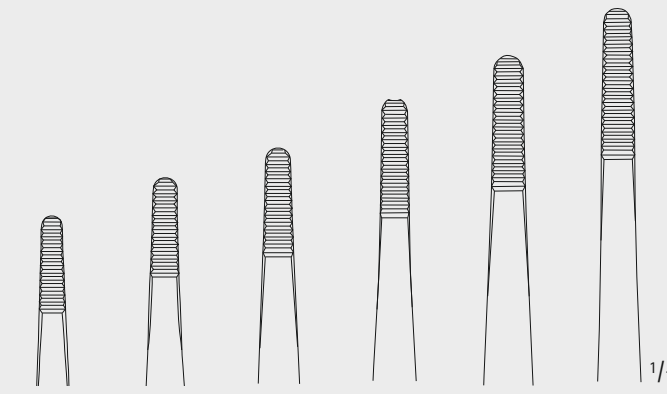

BD043R	BD045R	BD047R	BD049R	BD050R	BD051R
115 mm 4 1/2"	130 mm 5 1/8"	145 mm 5 3/4"	160 mm 6 1/4"	180 mm 7"	200 mm 7 7/8"

BD043R-BD051R

Standard patterns
Standard-Modelle

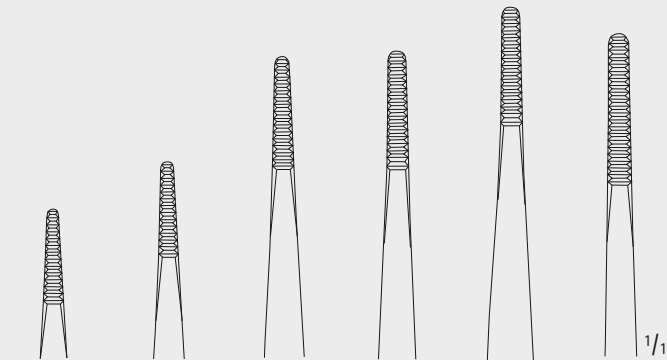

BD023R	BD025R	BD027R	BD029R	BD030R	BD031R
115 mm 4 1/2"	130 mm 5 1/8"	145 mm 5 3/4"	160 mm 6 1/4"	180 mm 7"	200 mm 7 7/8"

BD023R-BD031R

medium
mittelbreit

Forceps – Pinzetten

Dissecting Forceps

Anatomische Pinzetten

BD035R
130 mm
5 1/8"

BD037R
140 mm
5 3/4"

BD035R-BD037R
medium
mittelbreit

BD077R
extra large
extra breit
145 mm, 5 3/4"

BD065R 130 mm 5 1/8"	BD067R 150 mm 6"	BD068R 170 mm 6 3/4"	BD069R 200 mm 7 7/8"
-----------------------------------	-------------------------------	-----------------------------------	-----------------------------------

BD065R-BD069R
SWEDISH PATTERN
SCHWEDISCHES MODELL

BD130R
Ligature forceps
Fadenpinzette
145 mm, 5 3/4"

BD078R
175 mm, 6 7/8"

BD083R
180 mm, 7"

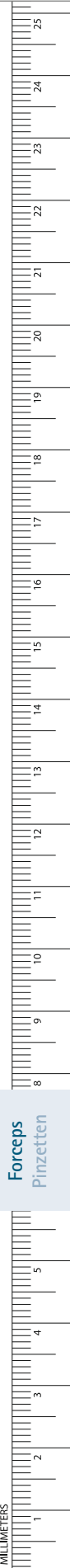

Forceps – Pinzetten

Atraumatic Forceps

Atraumatische Pinzetten

■ ATRAUMATA®

Toothing DE BAKEY



DE BAKEY Zahnung

■ ATRAUMATA®

Toothing COOLEY



COOLEY Zahnung



1.5 mm

1.2 mm



FC411R

150 mm, 6"



FC412R

200 mm, 7 7/8"

■ ERGOPLANT



DX303R

Micro forceps
Mikro-Pinzette
180 mm, 7"



1/1

1/2

Forceps
Pinzetten

INCHES

Forceps – Pinzetten

Atraumatic Forceps

Atraumatische Pinzetten

- Titanium
- Titan
- ATRAUMATA®
- Toothing DE BAKEY
- 
- DE BAKEY Zahnung



DE BAKEY
FB387T
145 mm, 5 3/4"



DE BAKEY
FB388T
195 mm, 7 3/4"



DE BAKEY
FB390T
145 mm, 5 3/4"



DE BAKEY
FB391T
195 mm, 7 3/4"

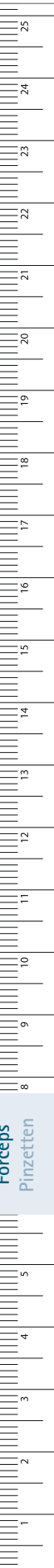

Forceps – Pinzetten

Atraumatic Forceps

Atraumatische Pinzetten

■ ATRAUMATA®

Toothing DE BAKEY



DE BAKEY Zahnung

1 mm 1 mm

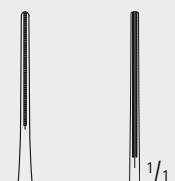

FB394R **FB395R**

150 mm 195 mm
6" 7 3/4"

DE BAKEY
FB394R-FB395R



1.5 mm 1.5 mm

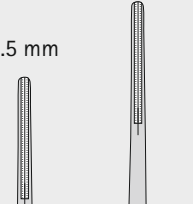

FB411R **FB412R**

150 mm 200 mm
6" 7 7/8"

DE BAKEY
FB411R-FB412R



2 mm 2 mm

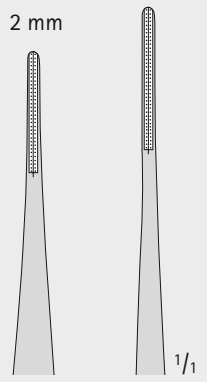

FB400R **FB402R**

150 mm 200 mm
6" 7 7/8"

DE BAKEY
FB400R-FB402R



2.8 mm 2.8 mm

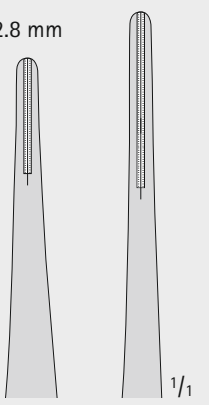

FB414R **FB415R**

150 mm 200 mm
6" 7 7/8"

DE BAKEY
FB414R-FB415R

Forceps
Pinzetten

INCHES

Forceps – Pinzetten

Atraumatic Forceps

Atraumatische Pinzetten

■ ATRAUMATA®

Toothing DE BAKEY



DE BAKEY Zahnung

■ ATRAUMATA®

Toothing COOLEY



COOLEY Zahnung

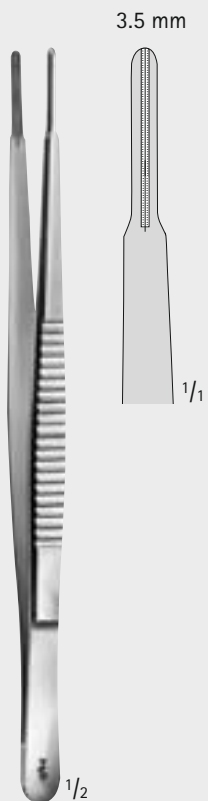

DE BAKEY

FB406R

200 mm, 7 7/8"

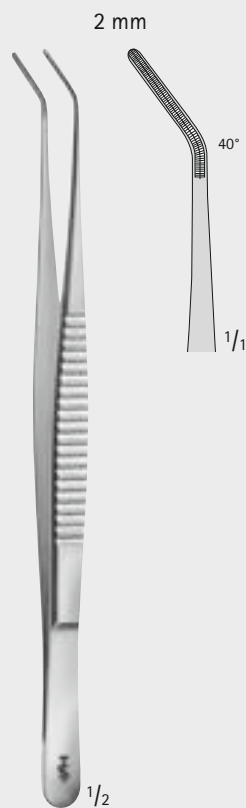

DE BAKEY

FB403R

200 mm, 7 7/8"

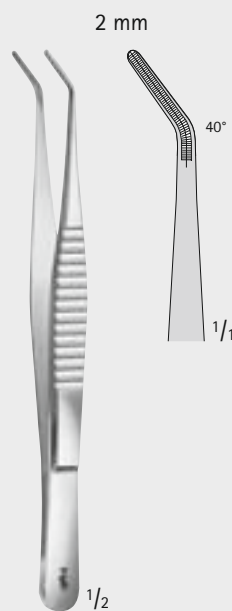

DE BAKEY

FB401R

150 mm, 6"

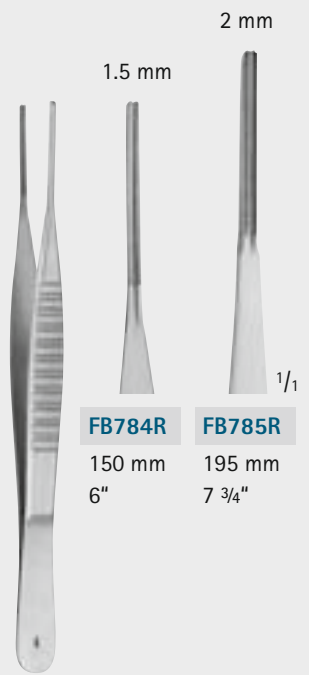

COOLEY

FB784R-FB785R

FB784R

150 mm
6"

FB785R

195 mm
7 3/4"

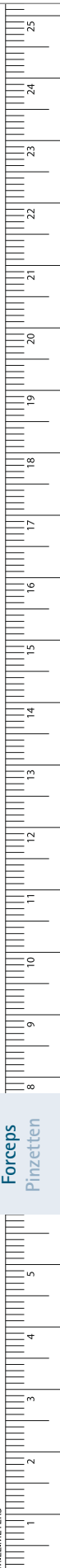

Forceps
Pinzetten

MILLIMETERS

Forceps – Pinzetten

DUROGRIP® Dissecting forceps

DUROGRIP® Pinzetten

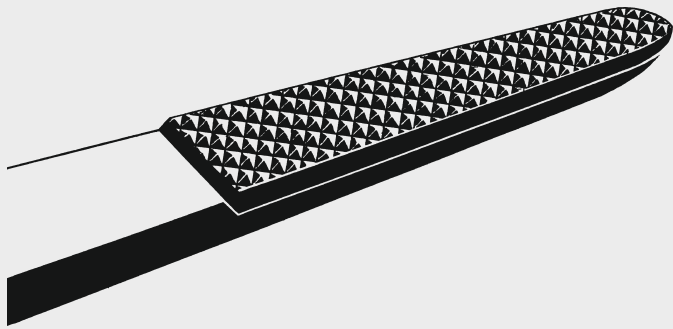

- Precisely worked out fine structure of carbide inserts
- Thus firm and non-traumatic gripping of tissue
- Universal in use – long working life
- Fein strukturiertes und präzise gearbeitetes Haftprofil
- Sicheres und zugleich schonendes Fassen
- Universell verwendbar – unverwüsthlich im Gebrauch



- DUROGRIP® Dissecting forceps with tungsten carbide inserts
 - Identification: gold-plated end
- DUROGRIP® Pinzetten mit Hartmetall-Plättchen
 - Kennzeichnung: vergoldete Feder

Forceps
Pinzetten

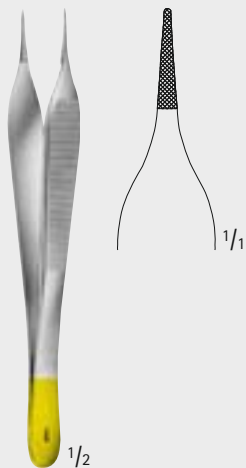

ADSON

BD151R

120 mm, 4 3/4"

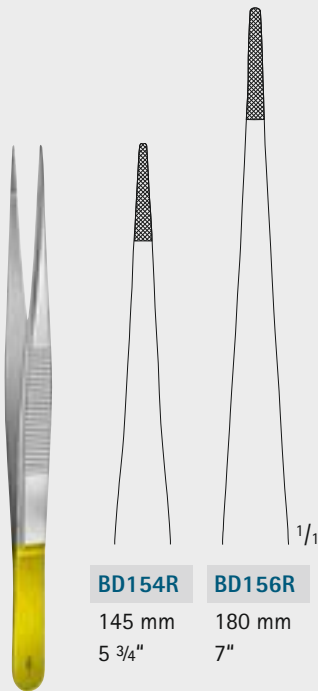

BD154R

145 mm
5 3/4"

BD156R

180 mm
7"

BD154R-BD156R

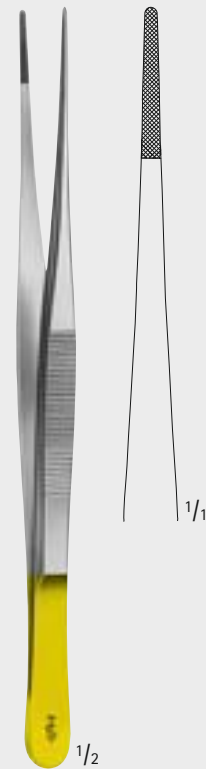

BD157R

200 mm, 7 7/8"

Forceps – Pinzetten

DUROGRIP® Dissecting forceps

DUROGRIP® Pinzetten



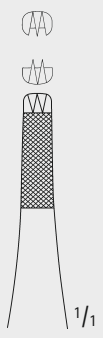

Cushion shaped tip ensures a safe and gentle grasping of the thread
 Besonders sicheres und schonendes Fassen des Fadens durch kissenförmige Maulform

BD180R
 200 mm, 7 7/8"

FERRIS-SMITH
BD181R
 175 mm, 6 7/8"

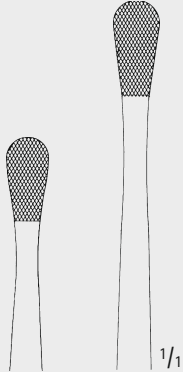
BD171R 150 mm, 6"
BD173R 230 mm, 9"

WANGENSTEEN
BD171R-BD173R





BD164R 145 mm, 5 3/4"
BD165R 200 mm, 7 7/8"

STANDARD
BD164R-BD165R





BD160R 180 mm, 7"
BD198R 250 mm, 9 3/4"

CUSHING
BD160R-BD198R
 with scraper end
 mit Schaber

BD168R 185 mm, 7 1/4"

GRUENWALD
BD168R

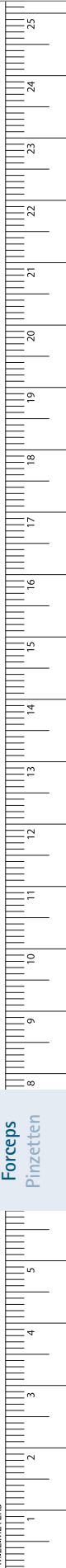

Forceps
 Pinzetten

MILLIMETERS

Forceps – Pinzetten

Forceps, Bayonet-Shaped

Pinzetten, bajonettförmig gebogen



LUCAE
BD878R
140 mm, 5 1/2"

LUCAE
BD879R
140 mm, 5 1/2"

COTTLE
OL011R
140 mm, 5 1/2"

JANSEN
BD880R
160 mm, 6 1/4"

ADSON
BD870R
175 mm, 6 7/8"

Forceps
Pinzetten

Forceps - Pinzetten

Forceps, Bayonet-Shaped

Pinzetten, bajonettförmig gebogen

1/2

1/1

GRUENWALD

BD883R

200 mm, 7 7/8"

1/2

1/1

smooth jaw
glattes Maul

BD887R

160 mm, 6 1/4"

1/2

1/1

1 x 2 teeth
1 x 2 Zähne

BD888R

160 mm, 6 1/4"

1/2

1/1

smooth jaw
glattes Maul

BD885R

185 mm, 7 1/4"

1/2

1/1

1 x 2 teeth
1 x 2 Zähne

BD886R

200 mm, 7 7/8"

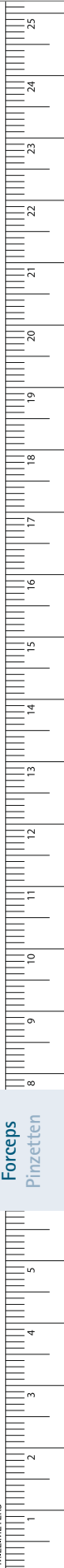

Forceps – Pinzetten

Forceps, Angular

Pinzetten, kniegebogen



TROELTSCH
BD900R
100 mm, 4"

TROELTSCH
BD902R
115 mm, 4 1/2"

1 x 2 teeth
1 x 2 Zähne

TROELTSCH
BD903R
115 mm, 4 1/2"

WILDE
BD904R
115 mm, 4 1/2"

TROELTSCH
BD905R
cross action
selbstschließend
120 mm, 4 3/4"

TROELTSCH
BD910R
140 mm, 5 1/2"

TROELTSCH
BD911R
170 mm, 6 3/4"

Forceps – Pinzetten

Delicate Tissue Forceps

Feine chirurgische Pinzetten

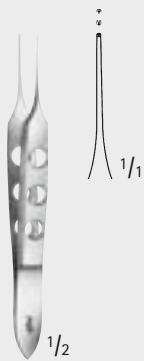

1/2 1/1

BISHOP-HARMON
OC051R
85 mm, 3 1/2"

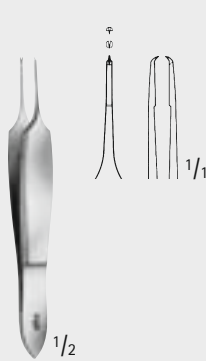

1/2 1/1

ST. MARTIN
OC091R
80 mm, 3 1/8"

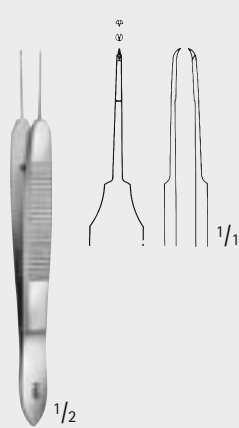

1/2 1/1

CASTROVIEJO
OC094R
100 mm, 4"

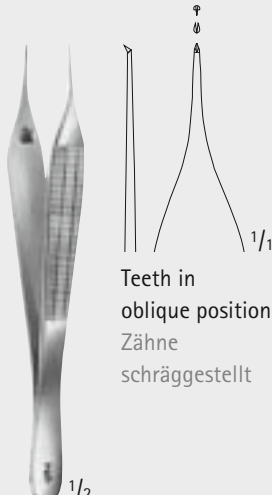

1/2 1/1

Teeth in oblique position
Zähne schräggestellt

MICRO-ADSON-BIEMER
BD509R
120 mm, 4 3/4"

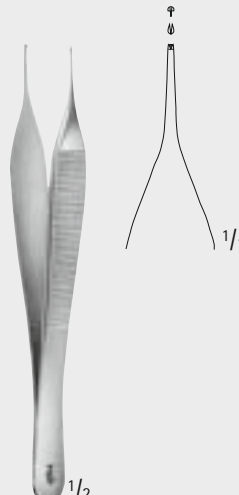

1/2 1/1

MICRO-ADSON
BD510R
120 mm, 4 3/4"

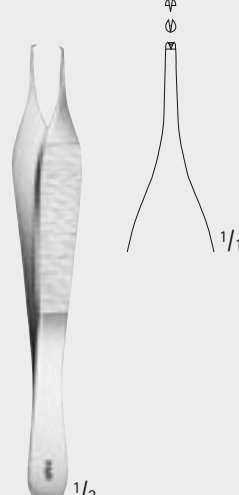

1/2 1/1

ADSON
BD511R
120 mm, 4 3/4"



1/2 1/1

with plateau
mit Plateau

ADSON
BD512R
120 mm, 4 3/4"



Forceps – Pinzetten

Delicate Tissue Forceps

Feine chirurgische Pinzetten



MICRO-ADSON
BD520R
150 mm, 6"

ADSON
BD522R
180 mm, 7"

JEFFERSON
BD523R
180 mm, 7"

ADSON
BD508R
120 mm, 4 3/4"

ADSON
BD513R
120 mm, 4 3/4"

with plateau
mit Plateau

ADSON
BD506R
120 mm, 4 3/4"

ADSON
BD507R
120 mm, 4 3/4"

ADSON
BD521R
150 mm, 6"

Forceps – Pinzetten

Delicate Tissue Forceps

Feine chirurgische Pinzetten

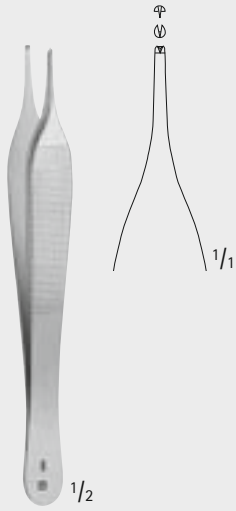

HUDSON
MB291R
125 mm, 5"

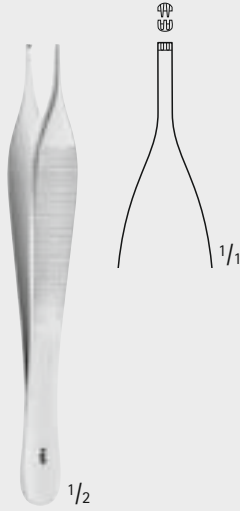

ADSON
MB454R
120 mm, 4 3/4"

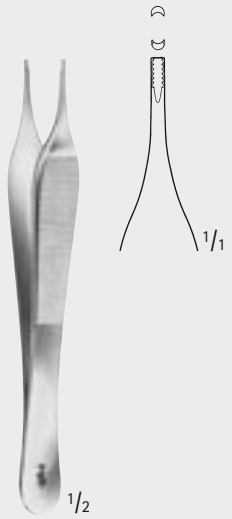

ADSON-BROWN
BD700R
Tissue forceps, sharp
Hautpinzette, scharf
120 mm, 4 3/4"



BROWN
BD701R 150 mm 6"
BD702R 200 mm 7 7/8"



GRAEFFE
OC100R
110 mm, 4 1/2"

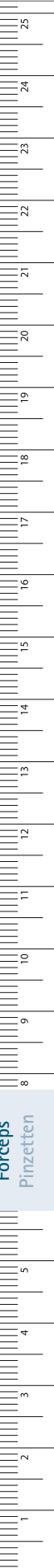

Forceps
Pinzetten

MILLIMETERS

Forceps – Pinzetten

Delicate Tissue Forceps

Feine chirurgische Pinzetten



OC024R **OC025R** **OC026R**

OC024R-OC026R
 very delicate
 sehr fein
 100 mm, 4"

BD500R
 100 mm, 4"

BD501R
 110 mm, 5 1/4"

BD502R
 110 mm, 5 1/4"

SEMKEN
BD665R-BD667R

BD665R 125 mm 5"
BD666R 125 mm 5"
BD667R 150 mm 6"

2 x 3 teeth
 2 x 3 Zähne

SEMKEN
BD668R-BD669R

BD668R 125 mm 5"
BD669R 145 mm 5 3/4"

Forceps
Pinzetten

Forceps – Pinzetten

Delicate Tissue Forceps

Feine chirurgische Pinzetten

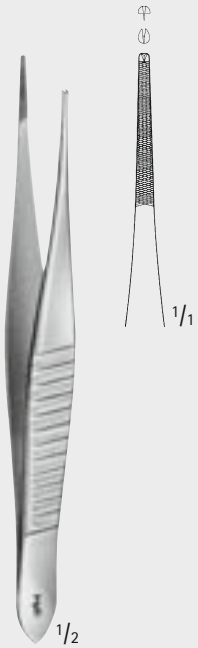

GILLIES

BD660R

155 mm, 6 1/8"



MC INDOE

BD661R

150 mm, 6"

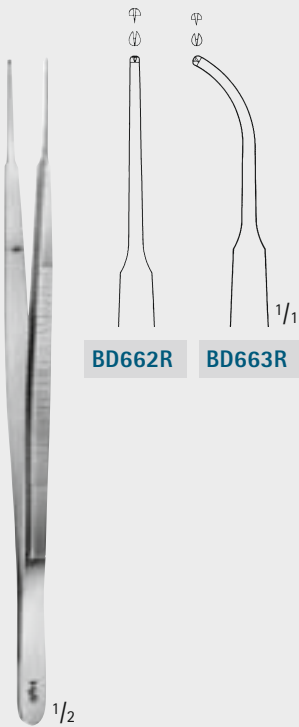

BD662R

BD663R

GERALD

BD662R-BD663R

175 mm, 6 7/8"

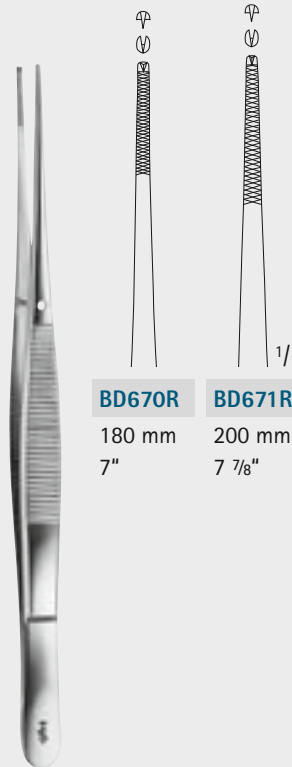

BD670R

180 mm
7"

BD671R

200 mm
7 7/8"

WAUGH

BD670R-BD671R

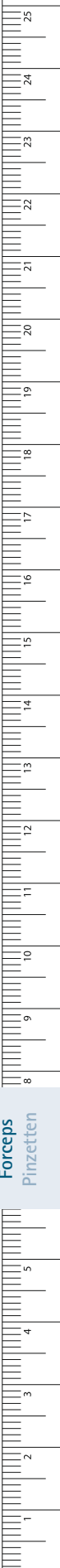

Forceps – Pinzetten

Tissue Forceps

Chirurgische Pinzetten



Forceps
Pinzetten

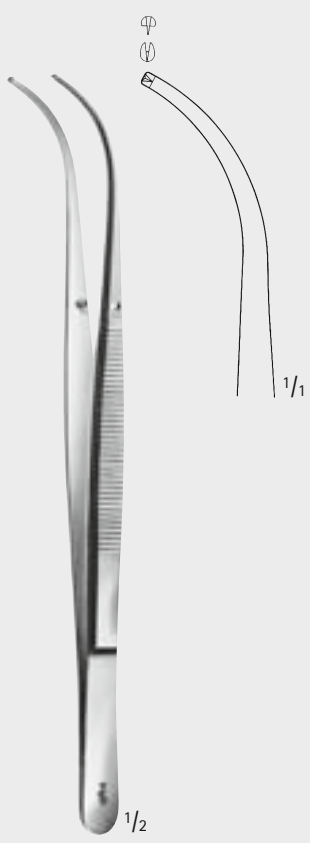

BROPHY
BD678R
200 mm, 7 7/8"

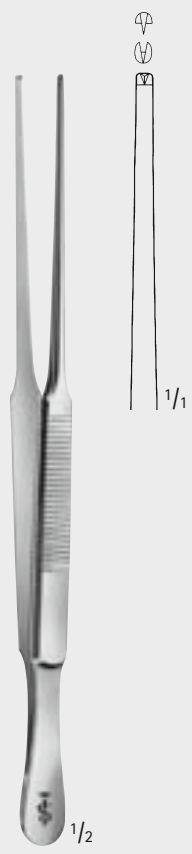

BD651R
200 mm, 7 7/8"



CUSHING
MD463
180 mm, 7"

Forceps – Pinzetten

Tissue Forceps

Chirurgische Pinzetten

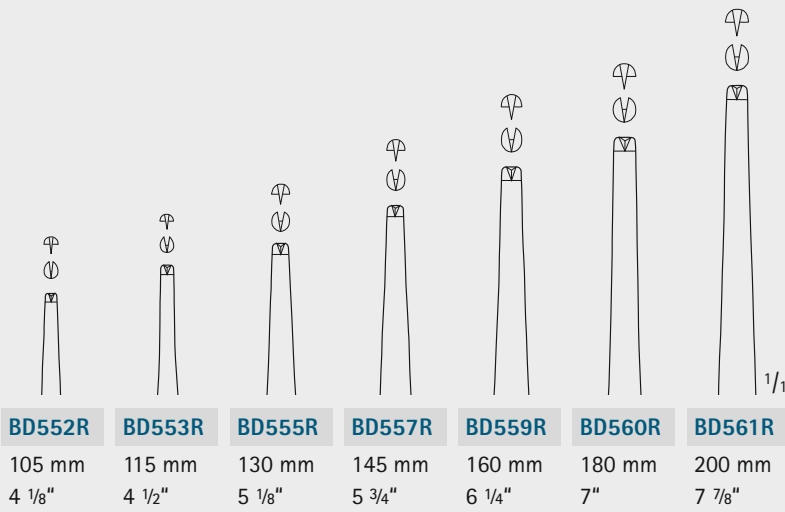

BD552R-BD561R

Standard patterns
Standard-Modelle

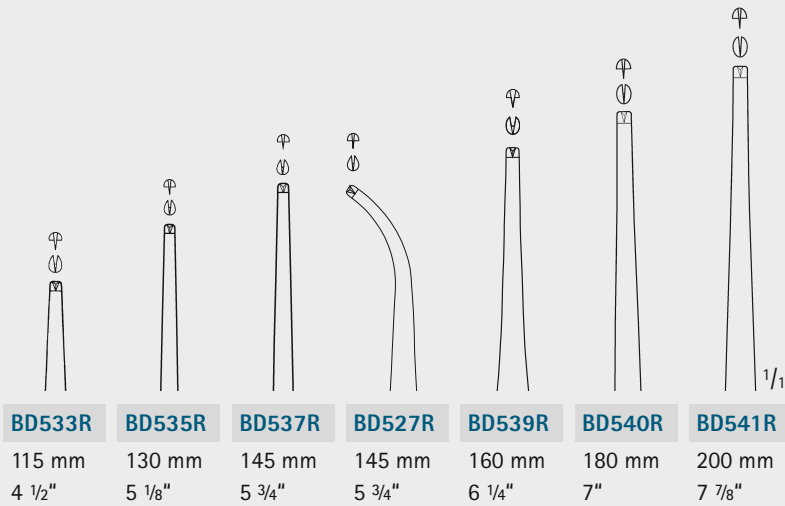

BD533R-BD541R

medium
mittelbreit

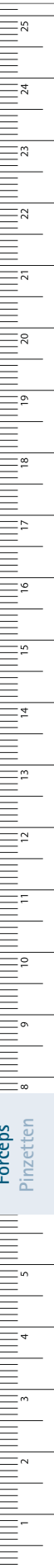

Forceps
Pinzetten

MILLIMETERS

Forceps – Pinzetten

Tissue Forceps

Chirurgische Pinzetten

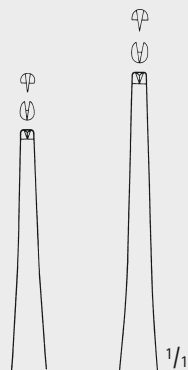

BD547R 145 mm 5 3/4"
BD549R 160 mm 6 1/4"

BD547R-BD549R



1/2

BD600R

145 mm, 5 3/4"

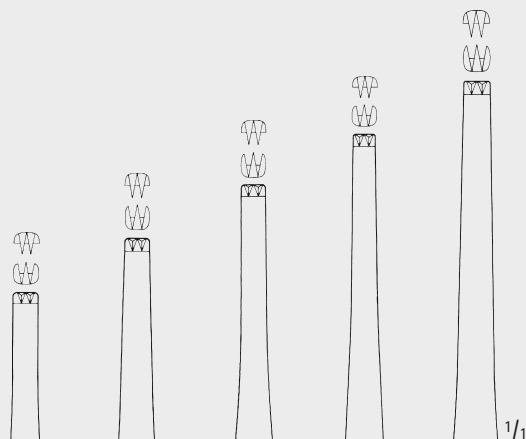

BD575R 130 mm 5 1/8"
BD577R 145 mm 5 3/4"
BD579R 160 mm 6 1/4"
BD580R 180 mm 7"
BD581R 200 mm 7 7/8"

BD575R-BD581R

2 x 3 teeth
 2 x 3 Zähne

Forceps – Pinzetten

Tissue Forceps

Chirurgische Pinzetten

Model	Length (mm)	Length (inches)	Teeth
BD587R	145 mm	5 3/4"	3 x 4 teeth
BD589R	160 mm	6 1/4"	3 x 4 teeth
BD591R	200 mm	7 7/8"	3 x 4 teeth

BD587R-BD591R
3 x 4 teeth
3 x 4 Zähne

Model	Length (mm)	Length (inches)	Teeth
BD597R	145 mm	5 3/4"	4 x 5 teeth

BD597R
145 mm, 5 3/4"
4 x 5 teeth
4 x 5 Zähne

Model	Length (mm)	Length (inches)	Teeth
BD598R	150 mm	6"	4 x 5 teeth

BD598R
150 mm, 6"
4 x 5 teeth
4 x 5 Zähne

OFFICER

Model	Length (mm)	Length (inches)	Teeth
BD602R	125 mm	5"	2 x 3 teeth
BD603R	145 mm	5 3/4"	2 x 3 teeth
BD604R	145 mm	5 3/4"	2 x 3 teeth
BD606R	175 mm	6 7/8"	2 x 3 teeth
BD607R	180 mm	7"	2 x 3 teeth

BD602R-BD607R
2 x 3 teeth
2 x 3 Zähne

LANE

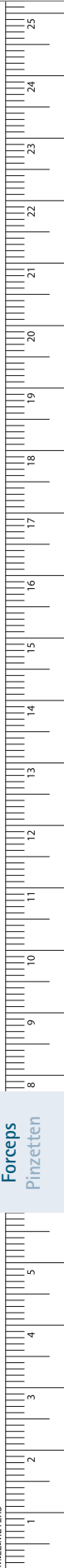

Forceps – Pinzetten

Tissue Forceps

Chirurgische Pinzetten



BD690R **BD692R**
 150 mm 200 mm
 6" 7 7/8"

STRASSBURGER MODELL
BD690R–BD692R

BD735R **BD736R**
 4 x 5 teeth 4 x 5 teeth
 4 x 5 Zähne 4 x 5 Zähne
 145 mm 200 mm
 5 3/4" 7 7/8"

ADLERKREUZ
BD735R–BD736R
 Vascular and tumor forceps
 Gefäß- und Tumorpinzette

BD725R **BD726R**
 3 x 4 teeth 3 x 4 teeth
 3 x 4 Zähne 3 x 4 Zähne
 180 mm 200 mm
 7" 7 7/8"

STILLE-BARRAYA
BD725R–BD726R

RUSS. MODELL
BD755R
 150 mm, 6"

RUSS. MODELL
BD760R
 200 mm, 7 7/8"

SELMAN
BD750R
 155 mm, 6 1/8"

Forceps
Pinzetten

Forceps – Pinzetten

Splinter Forceps

Splitterpinzetten



BD952R

Splinter forceps
Splitterpinzette
80 mm, 3 1/8"



BD963R

75 mm
3"



BD964R

95 mm
3 3/4"



BD965R

115 mm
4 1/2"



FEILCHENFELD

BD963R–BD965R

Splinter forceps
Splitterpinzetten

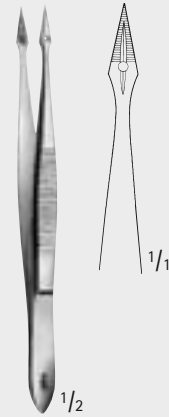

HUNTER

BD980R

105 mm, 4 1/8"

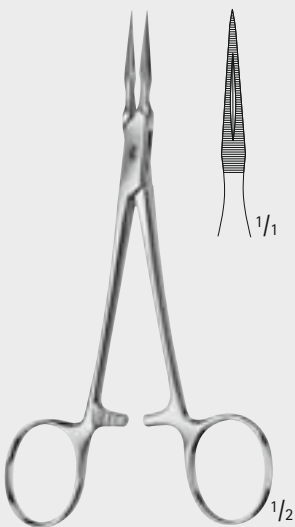

STIEGLITZ

BD992R

Splinter forceps
Splitterzange
140 mm, 5 1/2"

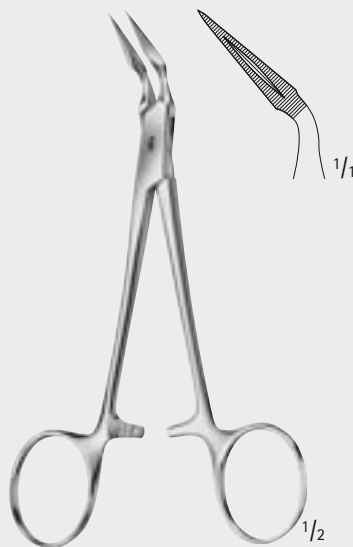

STIEGLITZ

BD993R

Splinter forceps
Splitterzange
140 mm, 5 1/2"



PEET

BD995R

Splinter forceps
Splitterzange
120 mm, 4 3/4"

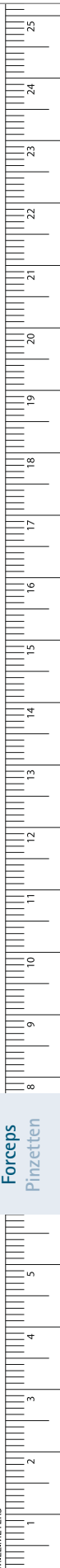

Forceps - Pinzetten

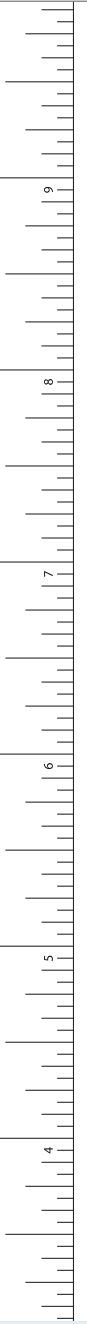

Forceps
Pinzetten

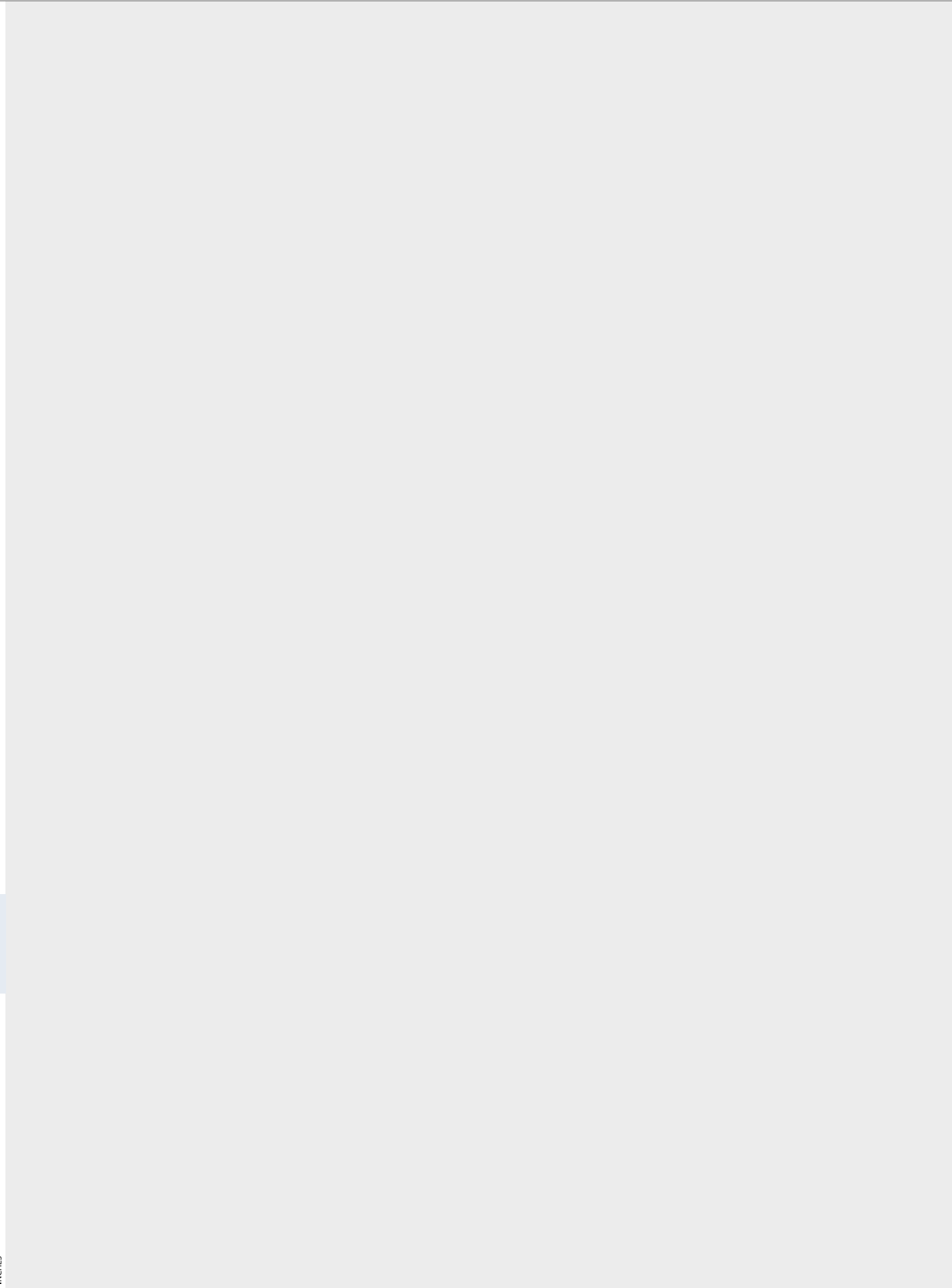

General Surgical Instruments Chirurgische Instrumente

- Clamps
- Klemmen

Clips, Clamps – Clips, Klemmen

Vessel Clips

Gefäßclips

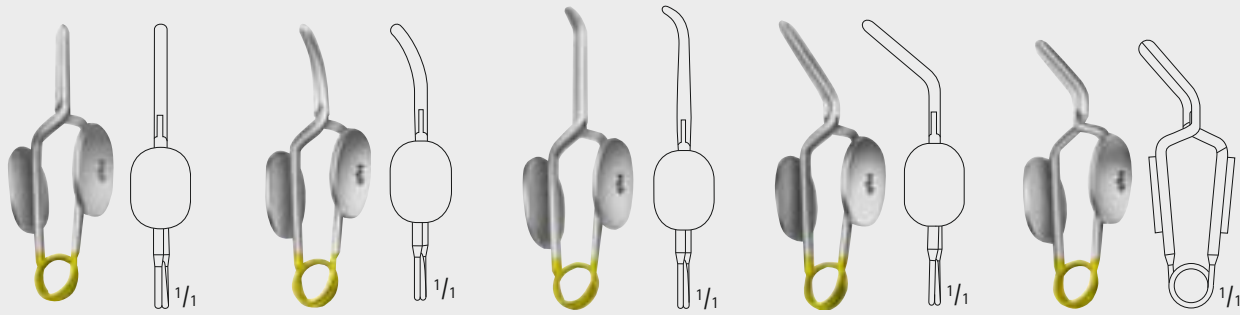

FE010K, FE020K

FE011K, FE021K

FE012K, FE022K

FE013K, FE023K

FE014K, FE024K

MÜLLER

Art. No. Art. Nr.	Jaw Maulteil	Closing force Schließkraft
FE010K	straight gerade	50 g
FE011K	curved gebogen	50 g
FE012K	curved tips Spitze gebogen	50 g
FE013K	angled to side zur Seite abgewinkelt	50 g
FE014K	angled kniegebogen	50 g
FE020K	straight gerade	80 g
FE021K	curved gebogen	80 g
FE022K	curved tips Spitze gebogen	80 g
FE023K	angled to side zur Seite abgewinkelt	80 g
FE024K	angled kniegebogen	80 g

Atraumatic vessel clips, temporary

Temporäre Gefäßclips mit atraumatischem Maulprofil



jaw profiles, cross-serrated
Maulprofil fein kariert

MÜLLER

FE005K

Ligature forceps
Fadenklemme

- For further vessel clips see chapter micro vascular surgery, starting on page 192
- Weitere Gefäßclips siehe Kapitel Mikro-Gefäßchirurgie, ab Seite 192

Clips, Clamps – Clips, Klemmen

Bulldog Clamps

Bulldogklemmen

- Forceps for applying and removing bulldog clamps BH011R–BH031R and FB420R–FB427R
- Zange zum Anlegen und Abnehmen der Bulldogklemmen BH011R–BH031R und FB420R–FB427R



JOHNS-HOPKINS

BH018R

240 mm, 9 1/2"

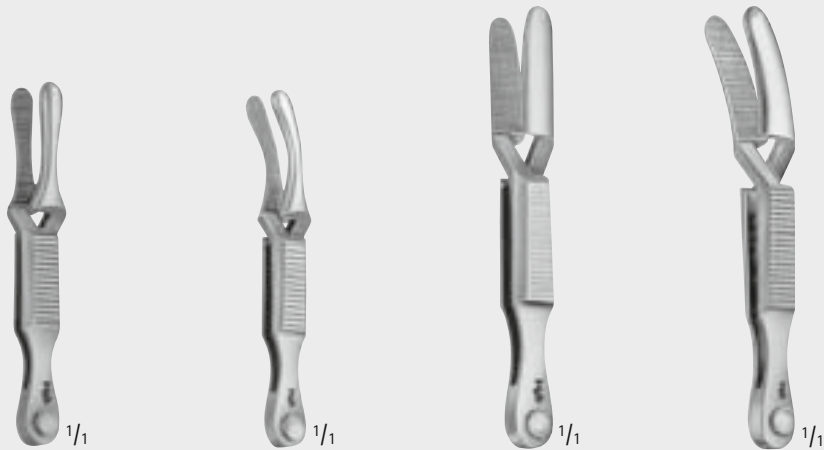

BH020R, BH022R

BH021R, BH023R

BH026R

BH027R

DIEFFENBACH

Art. No.	Jaw	Length of jaw serration	Length
Art. Nr.	Maulteil	Länge der Zahnung	Länge
BH020R	straight gerade	12 mm, 1/2"	38 mm, 1 1/2"
BH021R	curved gebogen	12 mm, 1/2"	38 mm, 1 1/2"
BH022R	straight gerade	16 mm, 5/8"	48 mm, 1 7/8"
BH023R	straight gerade	16 mm, 5/8"	48 mm, 1 7/8"
BH026R	straight gerade	16 mm, 5/8"	56 mm, 2 1/8"
BH027R	curved gebogen	16 mm, 5/8"	56 mm, 2 1/8"



BH011R–BH017R

JOHNS-HOPKINS

Art. No.	Jaw	Length of jaw serration	Length
Art. Nr.	Maulteil	Länge der Zahnung	Länge
BH011R	curved gebogen	12 mm, 1/2"	38 mm, 1 1/2"
BH012R	curved gebogen	17 mm, 5/8"	48 mm, 1 7/8"
BH013R	curved gebogen	25 mm, 1"	56 mm, 2 1/8"
BH014R	curved gebogen	30 mm, 1 1/4"	63 mm, 2 1/2"
BH015R	curved gebogen	33 mm, 1 1/4"	70 mm, 2 3/4"
BH016R	curved gebogen	42 mm, 1 1/2"	80 mm, 3 1/8"
BH017R	curved gebogen	52 mm, 2"	91 mm, 3 1/2"

Clamps
Klemmen

MILLIMETERS

Clips, Clamps – Clips, Klemmen

Bulldog Clamps

Bulldogklemmen



BH030R

DE BAKEY-HESS

Art. No. Art. Nr.	Jaw Maulteil	Jaw length Maullänge	Total Length Gesamtlänge
BH030R	angled abgewinkelt	20 mm, 3/4"	35 mm, 1 3/8"



FB328R

FB329R

FB330R

FB331R

Art. No. Art. Nr.	Jaw Maulteil	Length of jaw serration Länge der Zahnung	Total length Gesamtlänge
FB328R	straight gerade	14 mm, 1/2"	35 mm, 1 3/8"
FB329R	curved gebogen	14 mm, 1/2"	35 mm, 1 3/8"
FB330R	straight gerade	19 mm, 3/4"	45 mm, 1 3/4"
FB331R	curved gebogen	19 mm, 3/4"	45 mm, 1 3/4"



BH031R

DE BAKEY-HESS

Art. No. Art. Nr.	Jaw Maulteil	Jaw length Maullänge	Total length Gesamtlänge
BH031R	angled abgewinkelt	30 mm, 1 1/4"	40 mm, 1 1/2"

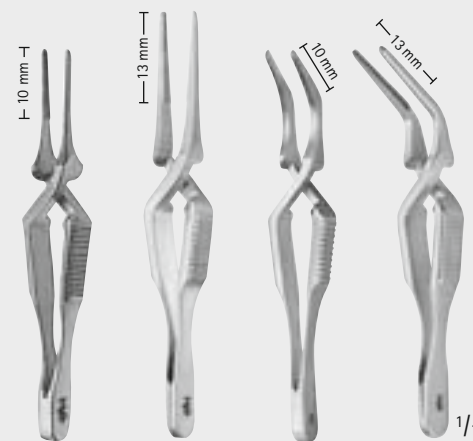

MB741R

MB285R

BH032R

BH034R

DIETRICH

Art. No. Art. Nr.	Jaw Maulteil	Jaw length Maullänge	Total length Gesamtlänge
MB741R	straight gerade	16 mm, 5/8"	52 mm, 2"
MB285R	straight gerade	20 mm, 3/4"	55 mm, 2 1/4"
BH032R	angled abgewinkelt	10 mm, 3/8"	48 mm, 1 7/8"
BH034R	angled abgewinkelt	13 mm, 1/2"	48 mm, 1 7/8"

Clamps
Klemmen

Clips, Clamps – Clips, Klemmen

Bulldog Clamps

Bulldogklemmen

- ATRAUMATA® Toothing DE BAKEY



DE BAKEY Zahnung

- Mini-bulldog clamps
Closing force 180 g
- Mini-Bulldogklemmen
Schließdruck 180 g

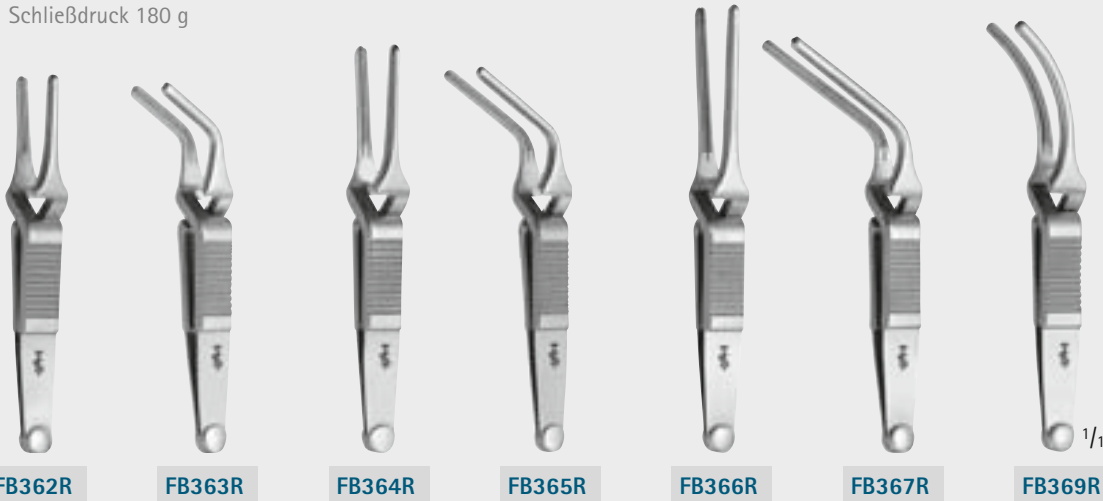

Art. No. Art. Nr.	Jaw Maulteil	Length of serration Länge der Zahnung	Total length Gesamtlänge
FB362R	straight gerade	10 mm, 3/8"	50 mm, 2"
FB363R	angled, 55° gewinkelt, 55°	10 mm, 3/8"	45 mm, 1 3/4"
FB364R	straight gerade	14 mm, 1/2"	55 mm, 2 1/4"
FB365R	angled, 55° gewinkelt, 55°	14 mm, 1/2"	50 mm, 2"
FB366R	straight gerade	20 mm, 3/4"	60 mm, 2 3/8"
FB367R	angled, 55° gewinkelt, 55°	20 mm, 3/4"	55 mm, 2 1/4"
FB369R	curved gebogen	20 mm, 3/4"	55 mm, 2 1/4"

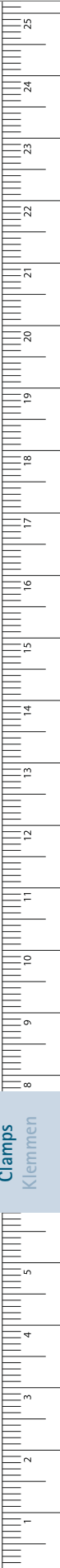

Clips, Clamps – Clips, Klemmen

Bulldog Clamps

Bulldogklemmen

■ ATRAUMATA® Toothing DE BAKEY



DE BAKEY Zahnung



DE BAKEY

Art. No. Art. Nr.	Jaw Maulteil	Length of serration Länge der Zahnung	Total length Gesamtlänge
FB420R	straight gerade	20 mm, 3/4"	80 mm, 3 1/8"
FB422R	straight gerade	30 mm, 1 1/4"	90 mm, 3 1/2"
FB424R	straight gerade	45 mm, 1 3/4"	105 mm, 4 1/8"
FB426R	straight gerade	65 mm, 2 1/2"	125 mm, 5"



DE BAKEY

Art. No. Art. Nr.	Jaw Maulteil	Length of serration Länge der Zahnung	Total length Gesamtlänge
FB421R	curved gebogen	20 mm, 3/4"	80 mm, 3 1/8"
FB423R	curved gebogen	30 mm, 1 1/4"	85 mm, 3 1/4"
FB425R	curved gebogen	45 mm, 1 3/4"	95 mm, 3 3/4"
FB427R	curved gebogen	65 mm, 2 1/2"	115 mm, 4 1/2"



GLOVER

Art. No. Art. Nr.	Jaw Maulteil	Length of serration Länge der Zahnung	Total length Gesamtlänge
FB432R	straight gerade	25 mm, 1"	70 mm, 2 3/4"
FB434R	straight gerade	40 mm, 1 1/2"	95 mm, 3 3/4"
FB436R	straight gerade	60 mm, 2 3/8"	115 mm, 4 1/2"



GLOVER

Art. No. Art. Nr.	Jaw Maulteil	Length of serration Länge der Zahnung	Total length Gesamtlänge
FB433R	curved gebogen	25 mm, 1"	65 mm, 2 1/2"
FB435R	curved gebogen	40 mm, 1 1/2"	90 mm, 3 1/2"
FB437R	curved gebogen	60 mm, 2 3/8"	110 mm, 4 1/4"

Clamps
Klemmen

INCHES

Clips, Clamps – Clips, Klemmen

Bulldog Clamps

Bulldogklemmen

■ ATRAUMATA® Toothing DE BAKEY



DE BAKEY Zahnung



FB382R

FB383R

GREGORY

Art. No. Art. Nr.	Jaw Maulteil	Length of jaw serration Länge der Zahnung	Total length Gesamtlänge
FB382R	angled abgewinkelt	50 mm, 2"	105 mm, 4 1/8"
FB383R	angled abgewinkelt	65 mm, 2 1/2"	120 mm, 4 3/4"

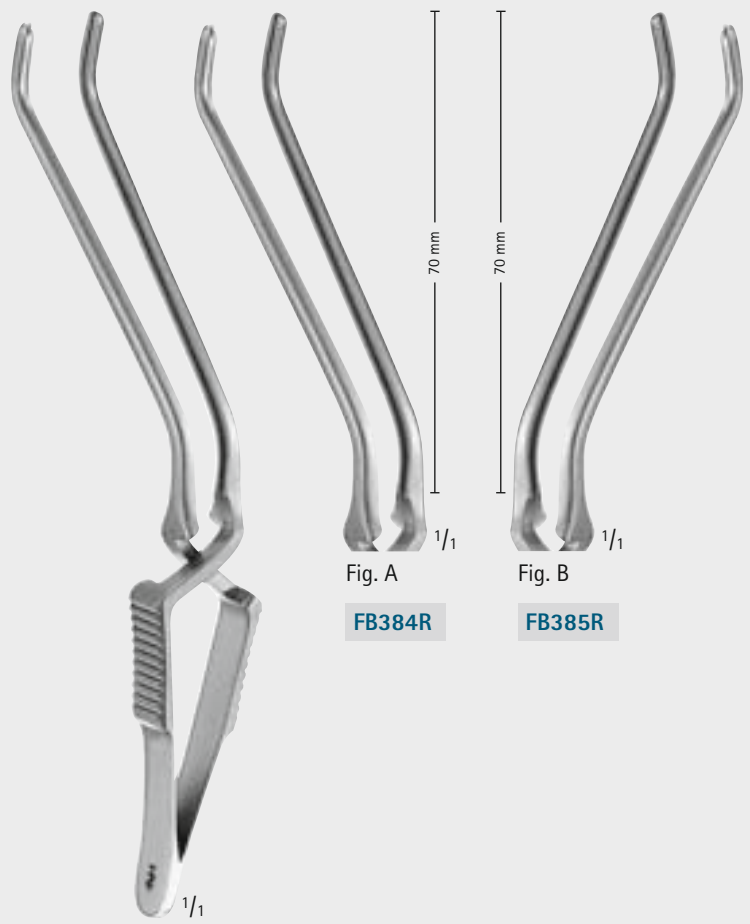

Fig. A

FB384R

Fig. B

FB385R

FB384R-FB385R

GREGORY

Art. No. Art. Nr.	Jaw Maulteil	Length of jaw serration Länge der Zahnung	Total length Gesamtlänge
FB384R	left curved links gebogen	70 mm, 2 3/4"	120 mm, 4 3/4"
FB385R	right curved rechts gebogen	70 mm, 2 3/4"	120 mm, 4 3/4"

Clamps
Klemmen

MILLIMETERS

Clips, Clamps – Clips, Klemmen

Atraumatic Clamps

Atraumatische Klemmen

■ ATRAUMATA® Toothing DE BAKEY



DE BAKEY Zahnung



DERRA

FB559R-FB561R



FB559R

170 mm
6 3/4"



FB560R

170 mm
6 3/4"

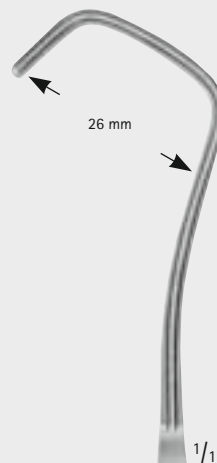

FB561R

175 mm
6 7/8"

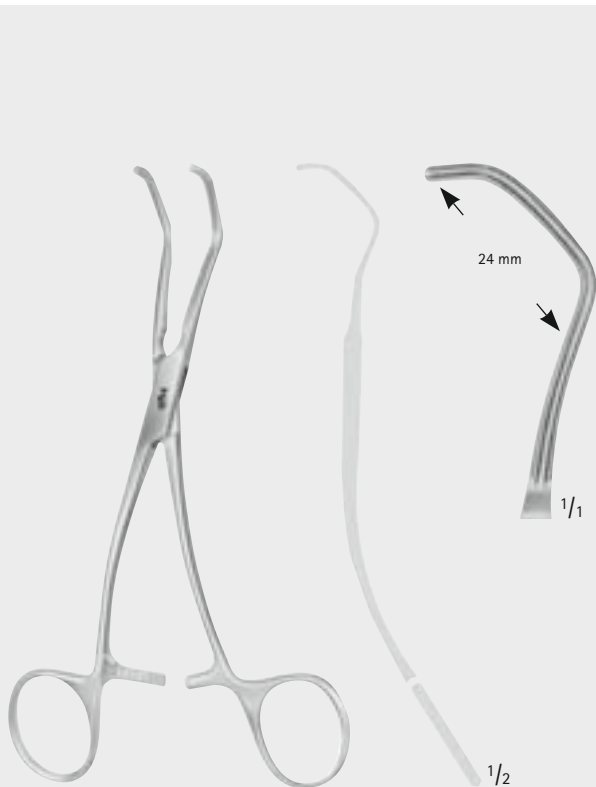

COOLEY

FB563R

160 mm, 6 1/4"

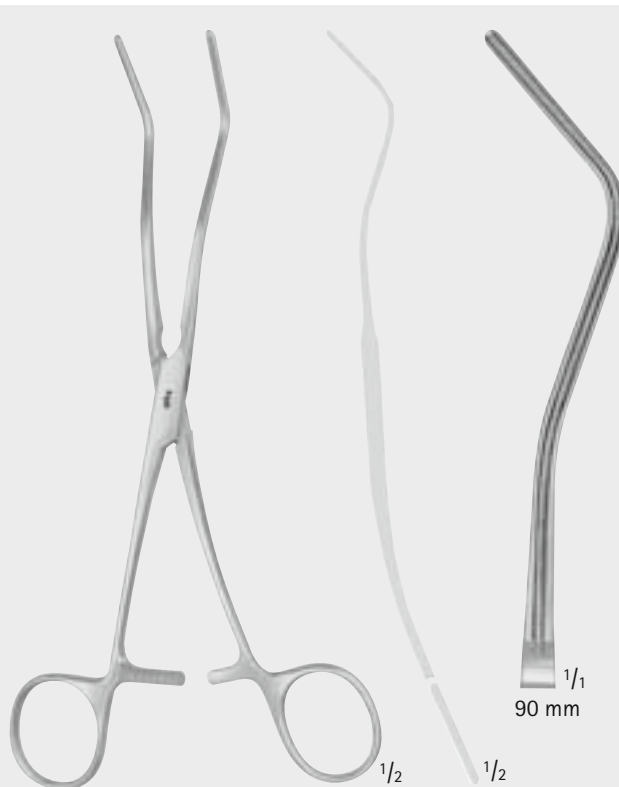

COOLEY

FB570R

200 mm, 7 7/8"



Clamps
Klemmen

Clips, Clamps – Clips, Klemmen

Dissecting and Ligature Clamps

Präparier-, Ligaturklemmen

■ ATRAUMATA®

Toothing DE BAKEY



DE BAKEY Zahnung

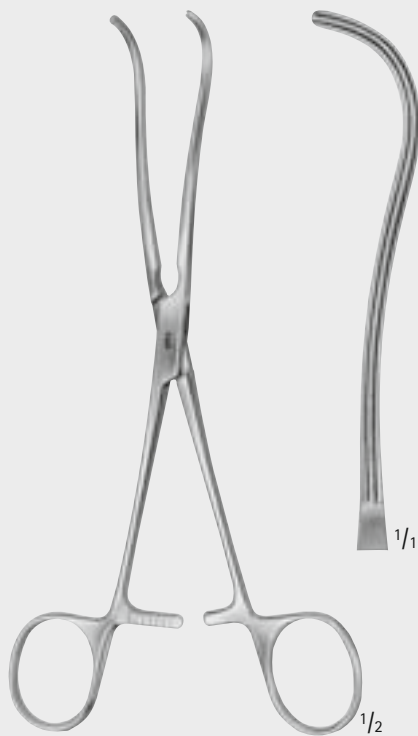

DE BAKEY

FB484R

190 mm, 7 1/2"



DE BAKEY

FB498R

210 mm, 8 1/4"

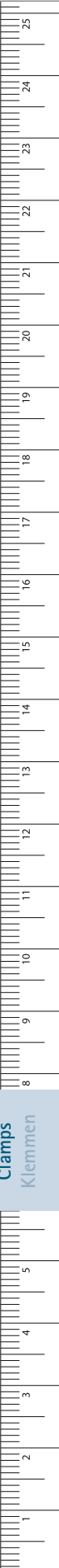

Clips, Clamps – Clips, Klemmen

Atraumatic Clamps

Atraumatische Klemmen

■ ATRAUMATA® Toothing DE BAKEY



DE BAKEY Zahnung

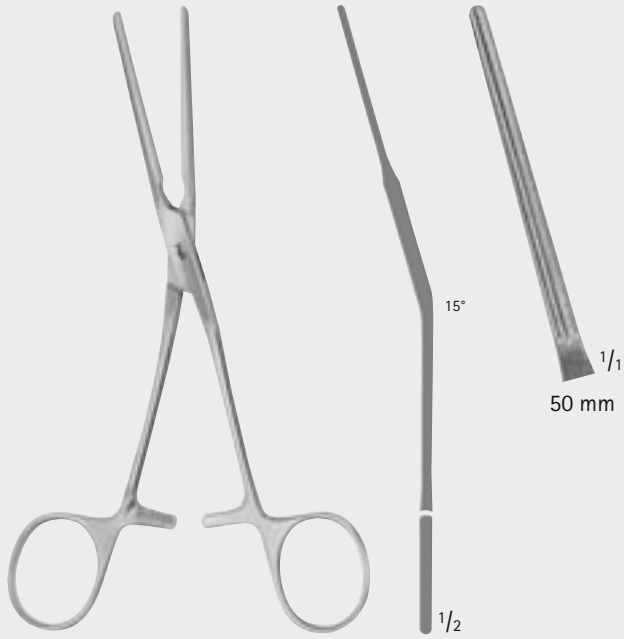

DE BAKEY

FB553R

165 mm, 6 1/2"

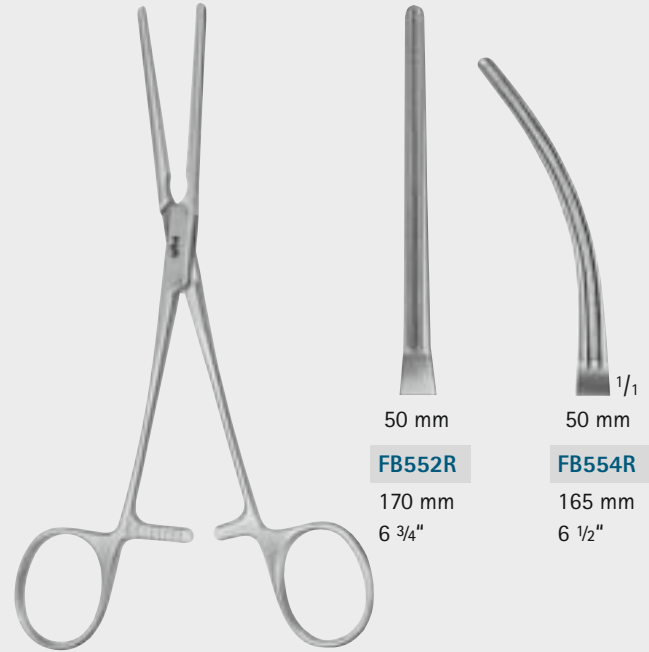

DE BAKEY

FB552R-FB554R

50 mm

FB552R

170 mm

6 3/4"

50 mm

FB554R

165 mm

6 1/2"



DE BAKEY

FB452R

205 mm, 8"



FB453R

200 mm

7 7/8"

FB455R

225 mm

8 7/8"

DE BAKEY

FB453R-FB455R

Clamps
Klemmen

INCHES

Clips, Clamps – Clips, Klemmen

Atraumatic Clamps

Atraumatische Klemmen

■ ATRAUMATA® Toothing DE BAKEY



DE BAKEY Zahnung

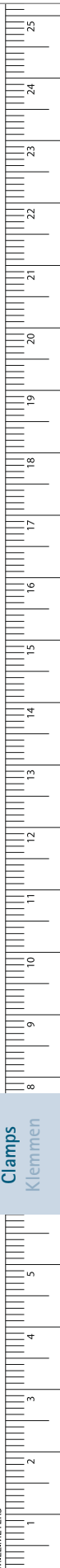
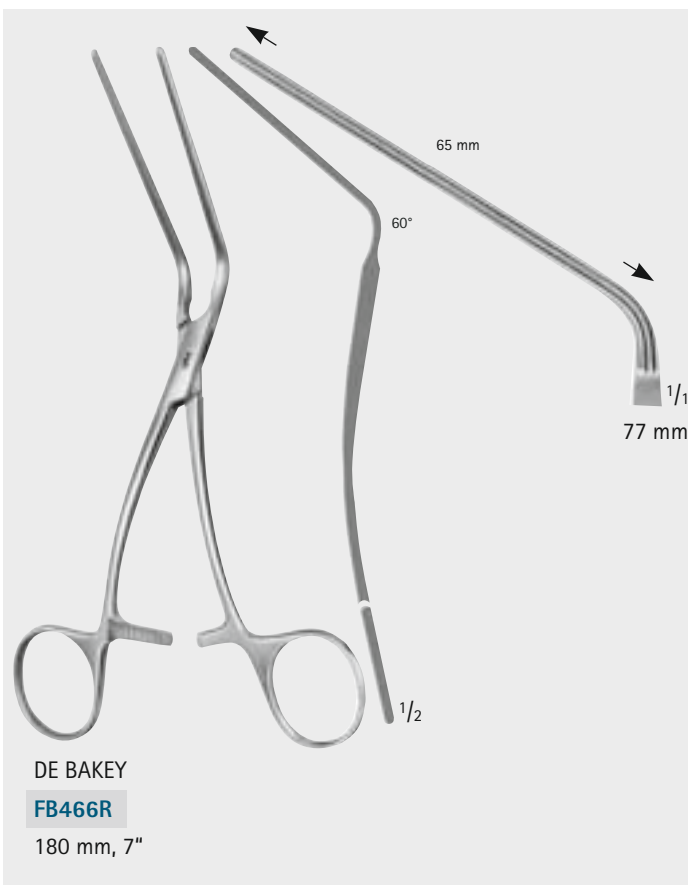
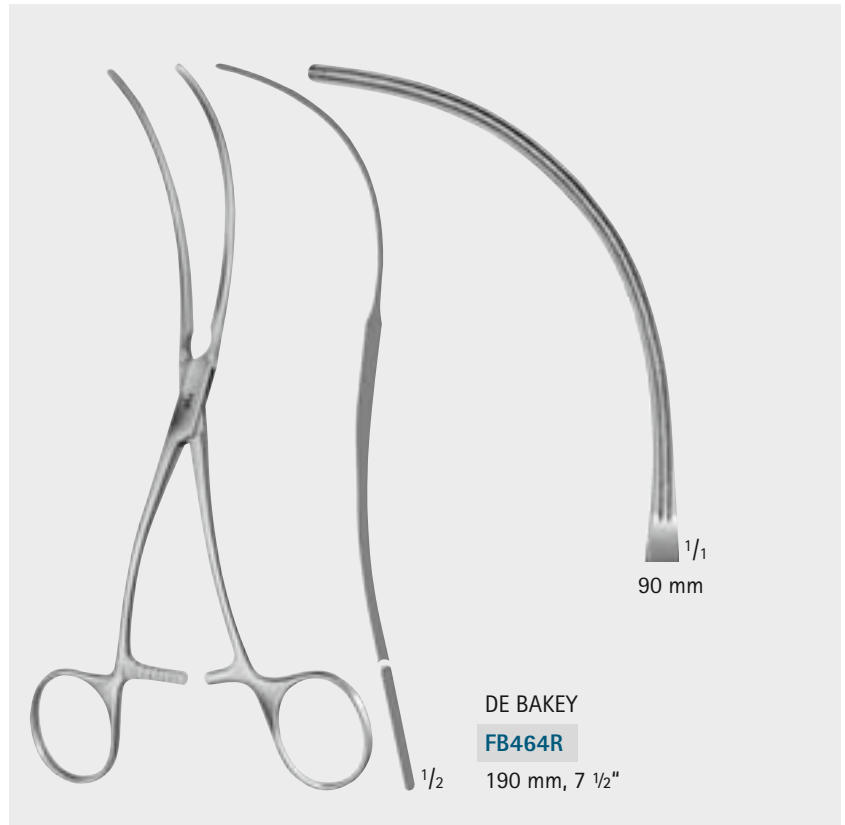
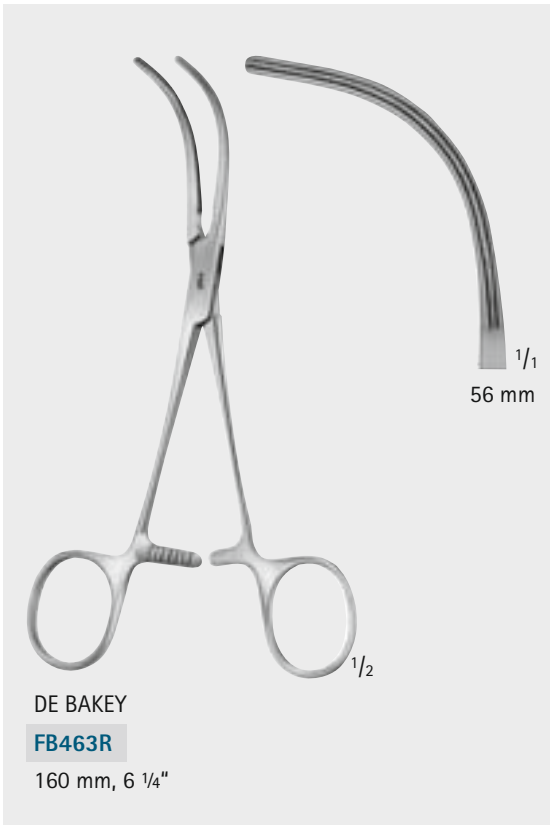

Clips, Clamps – Clips, Klemmen

Atraumatic Clamps

Atraumatische Klemmen

■ ATRAUMATA® Toothing DE BAKEY



DE BAKEY Zahnung

■ Titanium
■ Titan

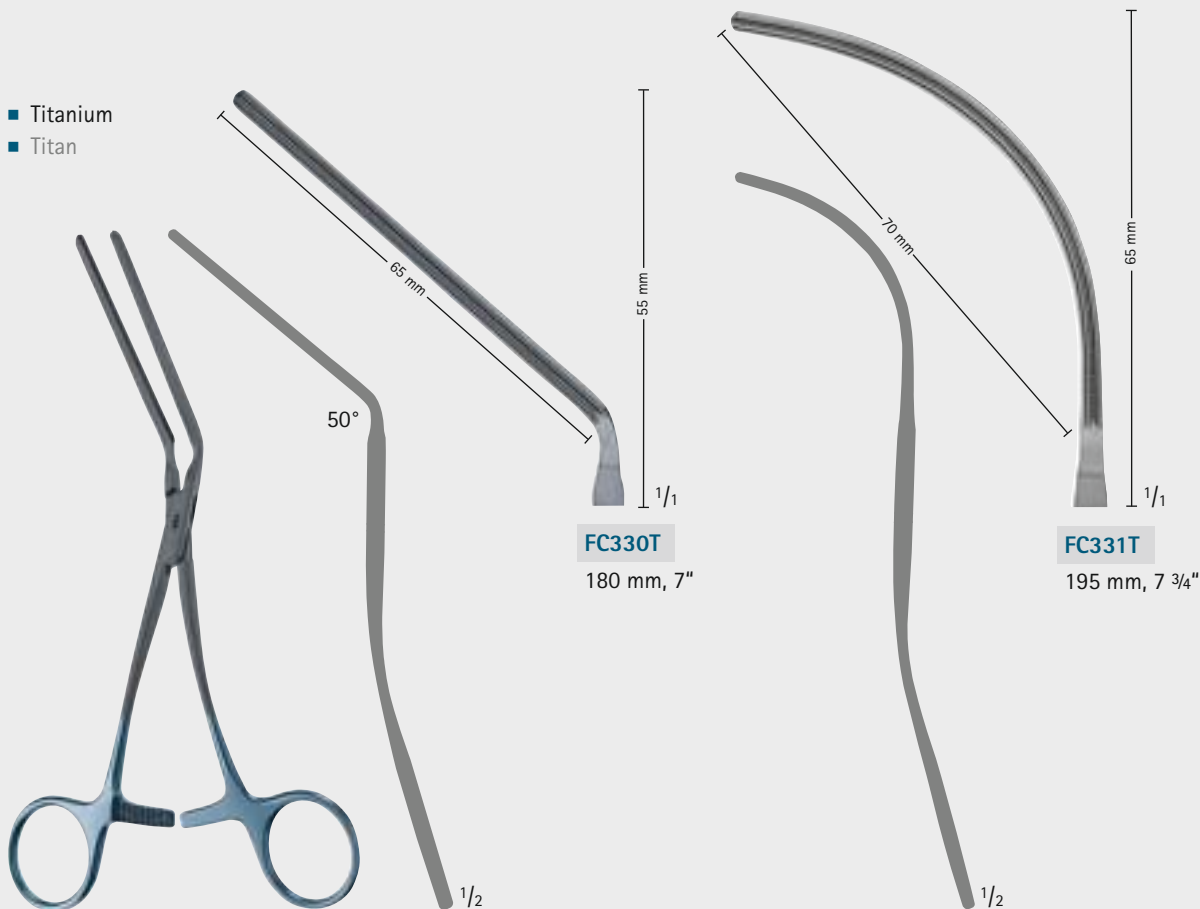

DE BAKEY
FC330T-FC331T

- Please find further atraumatic clamps in our main catalog for cardiovascular and thoracic surgery C05321.
- Weitere Atraumatische Klemmen, siehe Hauptkatalog Kardiovaskular C05321.

Clamps
Klemmen

INCHES

Clips, Clamps – Clips, Klemmen

Atraumatic Clamps

Atraumatische Klemmen

■ ATRAUMATA® Toothing DE BAKEY



DE BAKEY Zahnung



FC337T

110 mm
4 1/4"

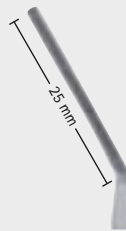

FC338T

110 mm
4 1/4"

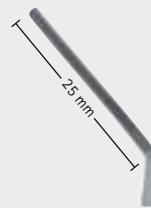

FC339T

110 mm
4 1/4"

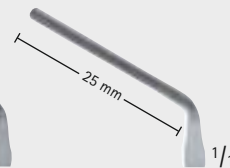

FC340T

110 mm
4 1/4"

■ Titanium

■ Titan



FC341T

95 mm
3 3/4"



FC342T

100 mm
4"



FC343T

100 mm
4"



DE BAKEY

FC337T-FC343T

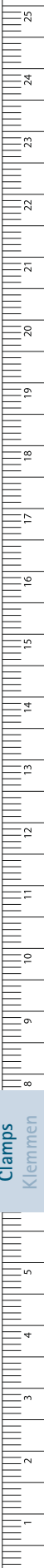

Clamps
Klemmen

MILLIMETERS

Clips, Clamps – Clips, Klemmen

Delicate Hemostatic Forceps

Feine Arterienklemmen



CARREL
BH100R
85 mm, 3 1/4"

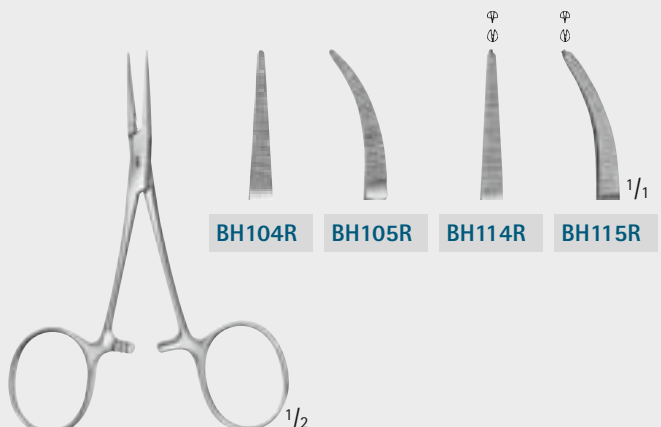

BH104R **BH105R** **BH114R** **BH115R**

BABY-MOSQUITO (HARTMANN)
BH104R-BH115R
100 mm, 4"

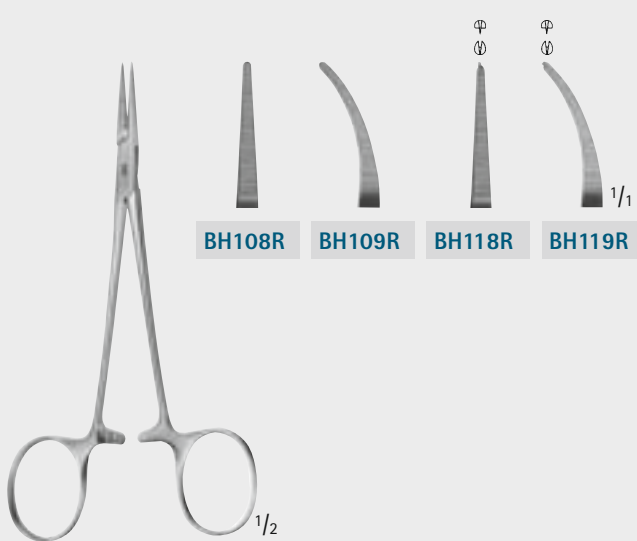

BH108R **BH109R** **BH118R** **BH119R**

MICRO-HALSTED
BH108R-BH119R
125 mm, 5"

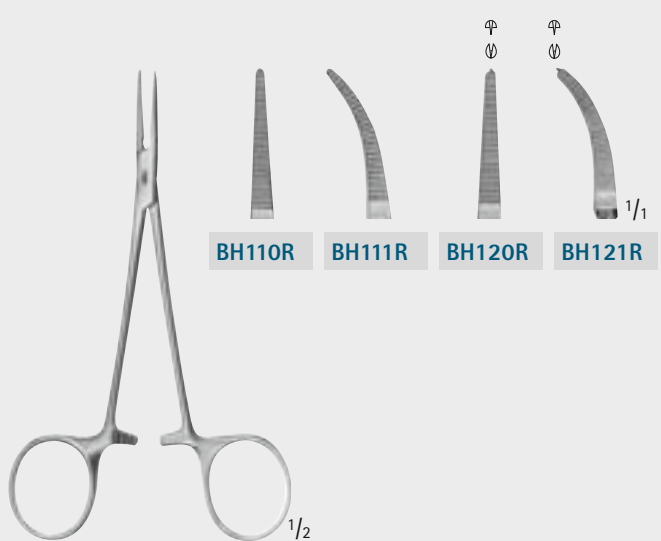

BH110R **BH111R** **BH120R** **BH121R**

HALSTED-MOSQUITO
BH110R-BH121R
125 mm, 5"

Clamps
Klemmen

Clips, Clamps – Clips, Klemmen

Delicate Hemostatic Forceps

Feine Arterienklemmen

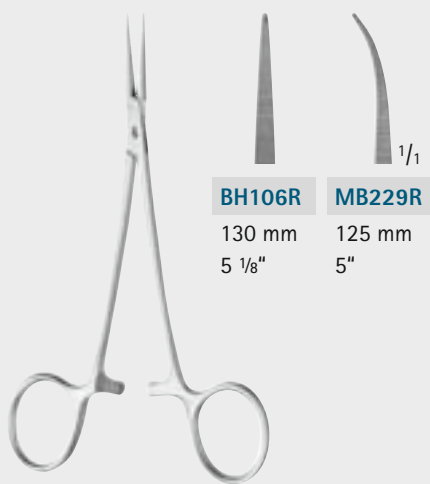

BH106R **MB229R**
 130 mm 125 mm
 5 1/8" 5"

JACOBSON
BH106R-MB229R



BH130R **BH131R**

PROVIDENCE-HOSPITAL
BH130R-BH131R
 140 mm, 5 1/2"

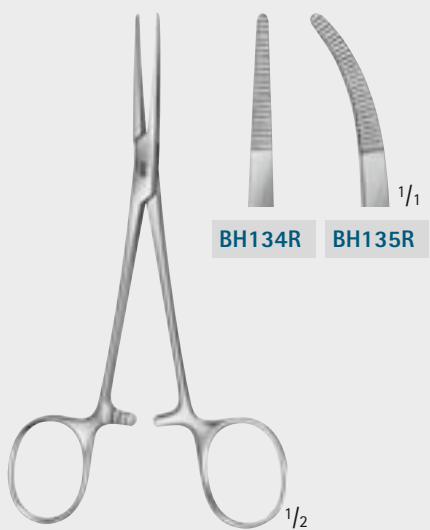

BH134R **BH135R**

KELLY
BH134R-BH135R
 140 mm, 5 1/2"



BH139R **BH143R**

DANDY
BH139R-BH143R
 140 mm, 5 1/2"

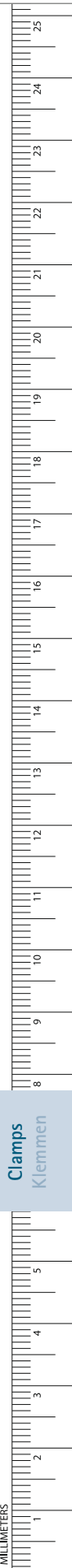

Clips, Clamps – Clips, Klemmen

Delicate Hemostatic Forceps

Feine Arterienklemmen

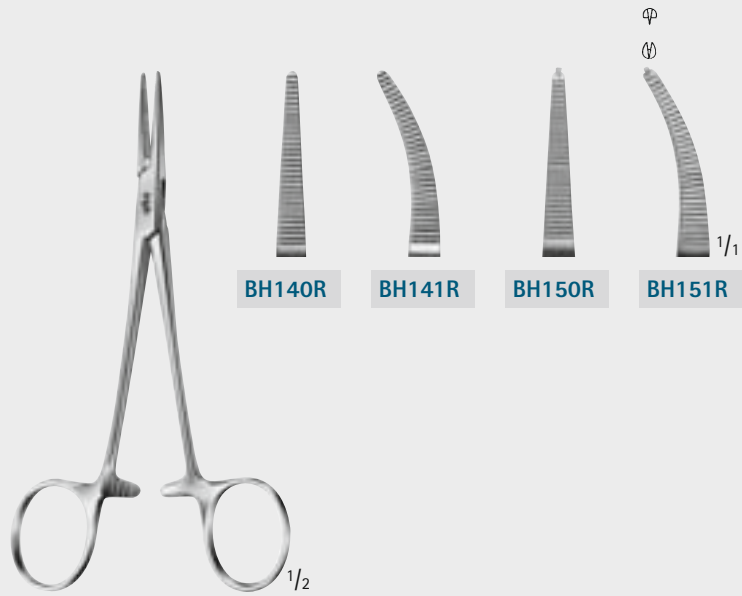

BH140R

BH141R

BH150R

BH151R

BABY-CRILE

BH140R-BH151R

140 mm, 5 1/2"

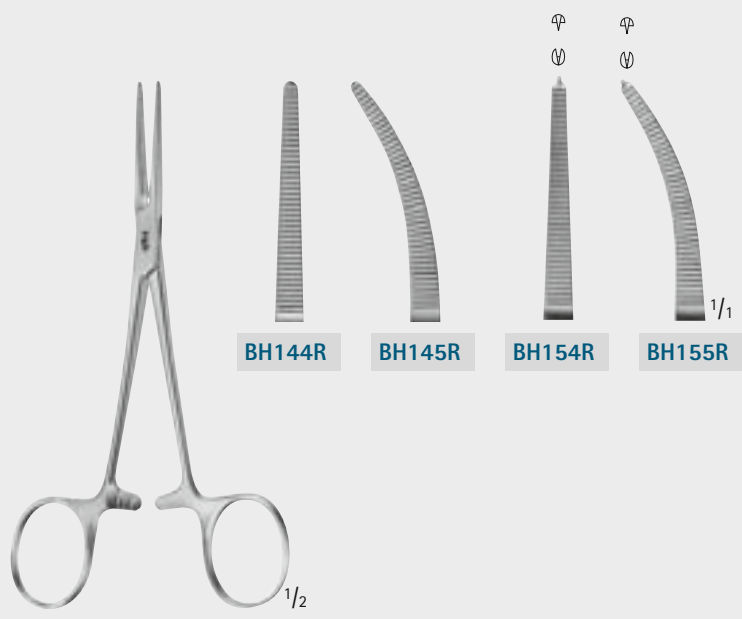

BH144R

BH145R

BH154R

BH155R

CRILE

BH144R-BH155R

140 mm, 5 1/2"



DUNHILL

BH123R

125 mm, 5"

Clamps
Klemmen

Clips, Clamps – Clips, Klemmen

Hemostatic Forceps

Arterienklemmen

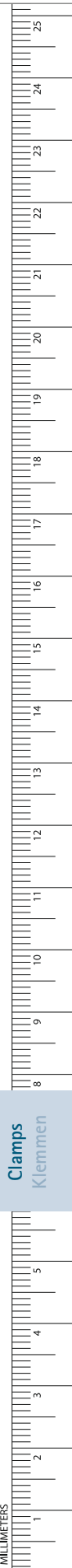
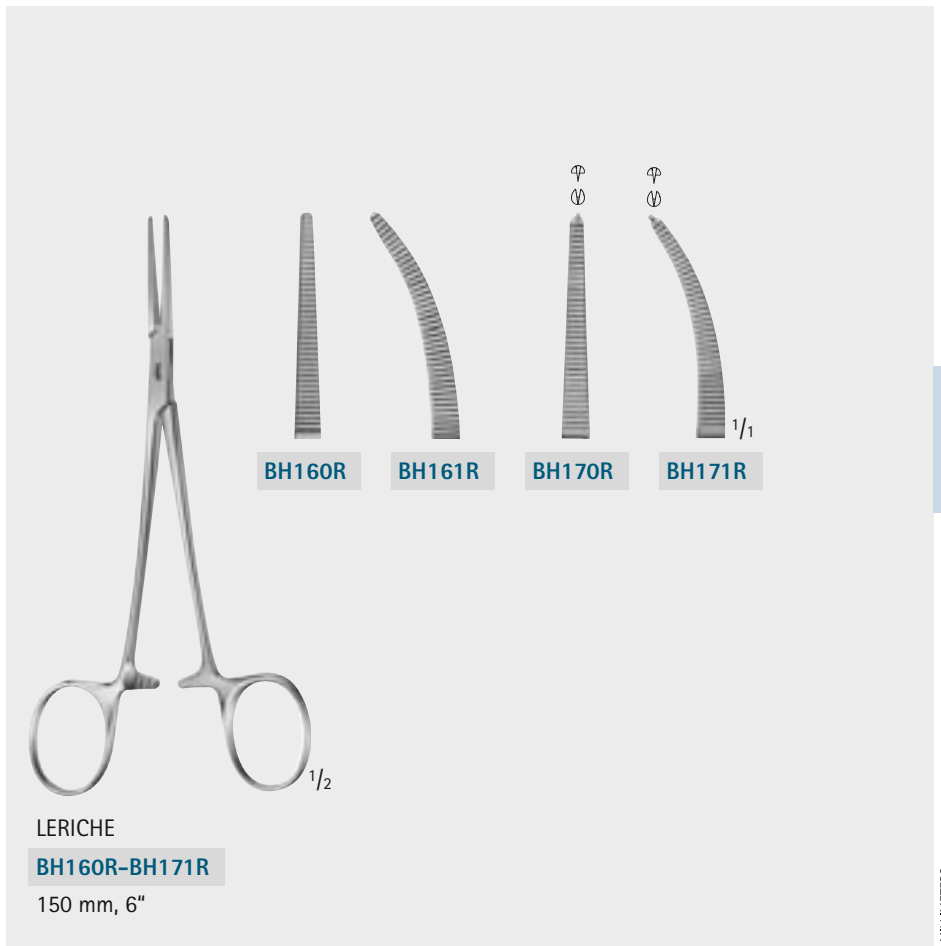
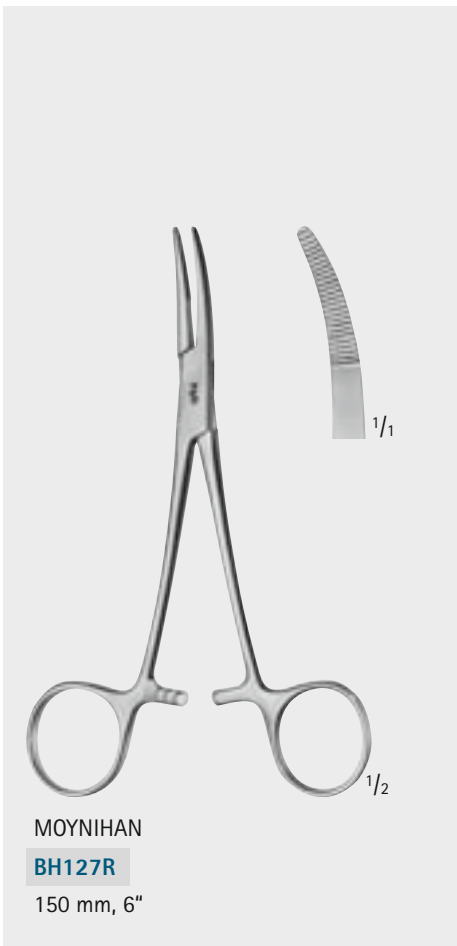
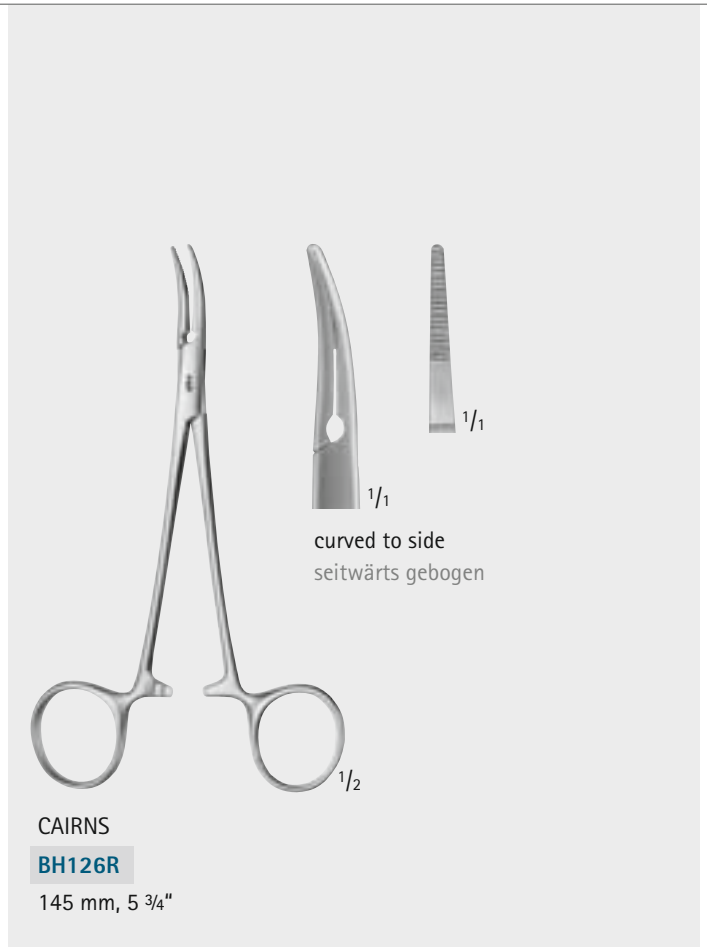
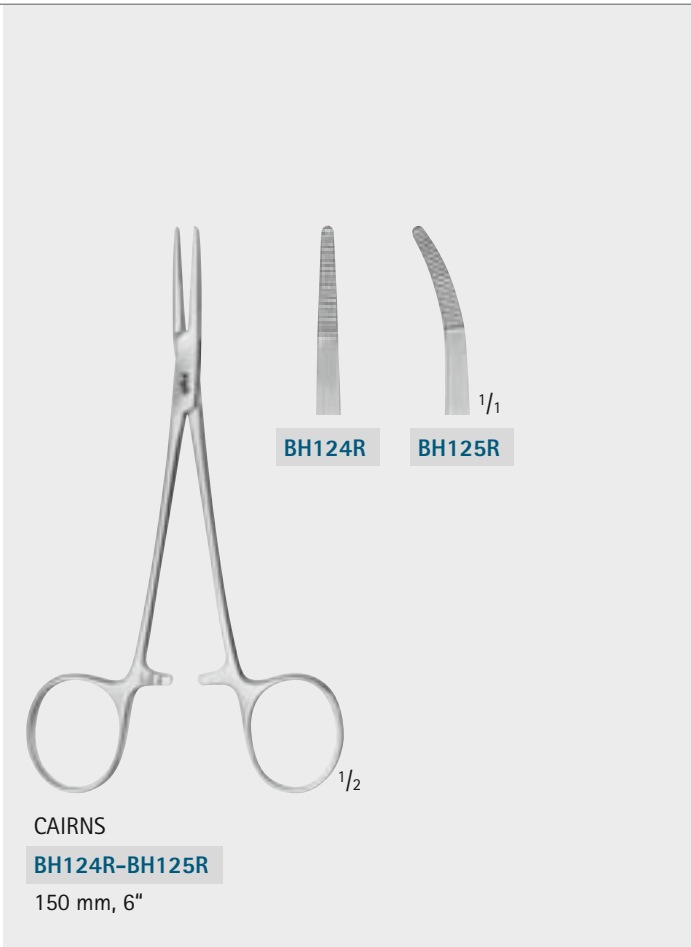





Clips, Clamps – Clips, Klemmen

Delicate Hemostatic Forceps

Feine Arterienklemmen

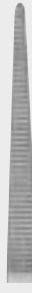

COLLER
MD464-MD469

					
MD464	MD466R	MD468	MD465R	MD467R	MD469
145 mm 5 3/4"	165 mm 6 1/2"	180 mm 7"	145 mm 5 3/4"	165 mm 6 1/2"	180 mm 7"





RANKIN
BH164R-BH165R
160 mm, 6 1/4"

	
BH164R	BH165R

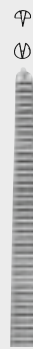
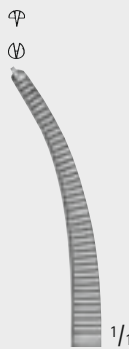

CRILE
BH166R-BH177R
160 mm, 6 1/4"

			
BH166R	BH167R	BH176R	BH177R

Clips, Clamps – Clips, Klemmen

Delicate Hemostatic Forceps

Feine Arterienklemmen

BH168R **BH178R**

DIXON-LOVELACE
BH168R-BH178R
160 mm, 6 1/4"

BH198R

FUCHSIG
BH198R
195 mm, 7 3/4"

BH199R

NISSEN
BH199R
185 mm, 7 1/4"

BH200R **BH201R**

ADSON
BH200R-BH201R
185 mm, 7 1/4"

BH202R **BH203R** **BH212R** **BH213R**

HALSTED
BH202R-BH213R
185 mm, 7 1/4"

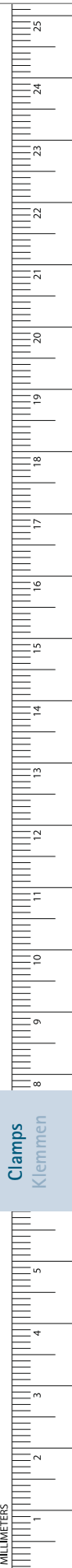

Clips, Clamps – Clips, Klemmen

Delicate Hemostatic Forceps

Feine Arterienklemmen



HALSTED-MOSQUITO
BH210R–BH215R
200 mm, 7 7/8"

BH210R **BH211R** **BH214R** **BH215R**

JACOBSON
BH187R
190 mm, 7 1/2"

ADSON
BH205R
215 mm, 8 1/2"

FRASER-KELLY (CRILE)
BH183R
180 mm, 7"

Clamps
Klemmen

Clips, Clamps – Clips, Klemmen

Delicate Hemostatic Forceps

Feine Arterienklemmen

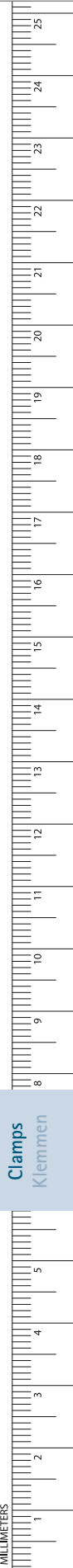
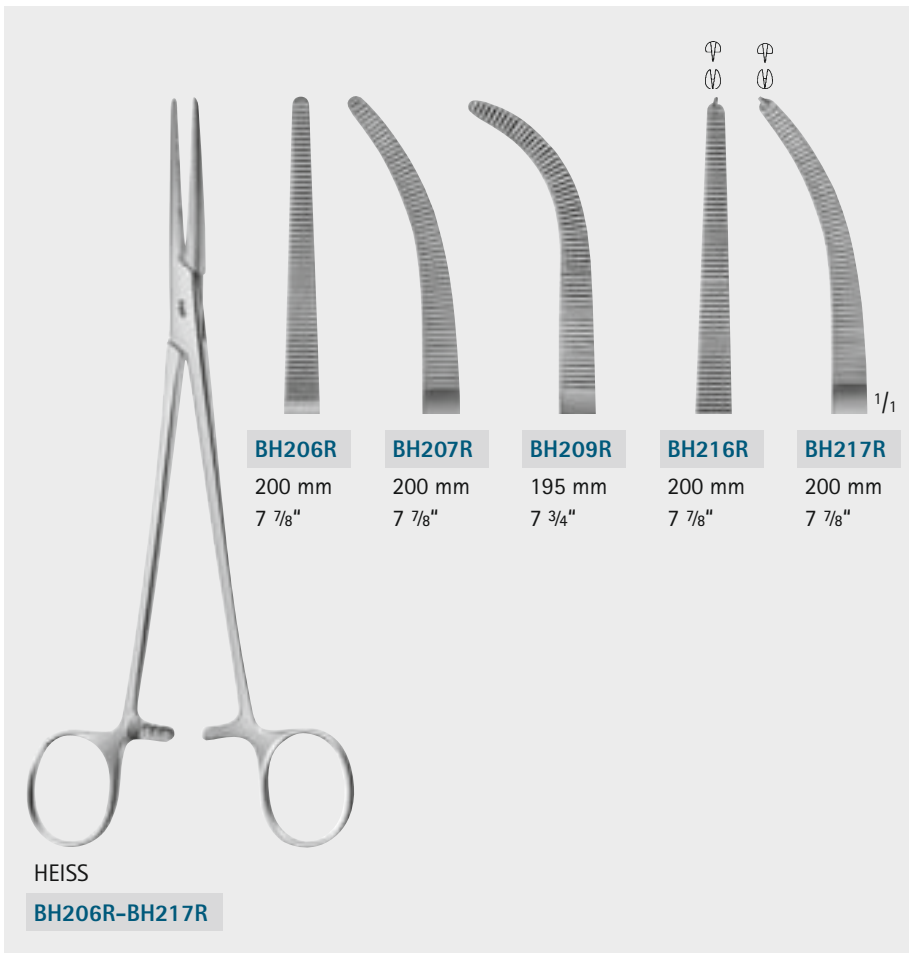
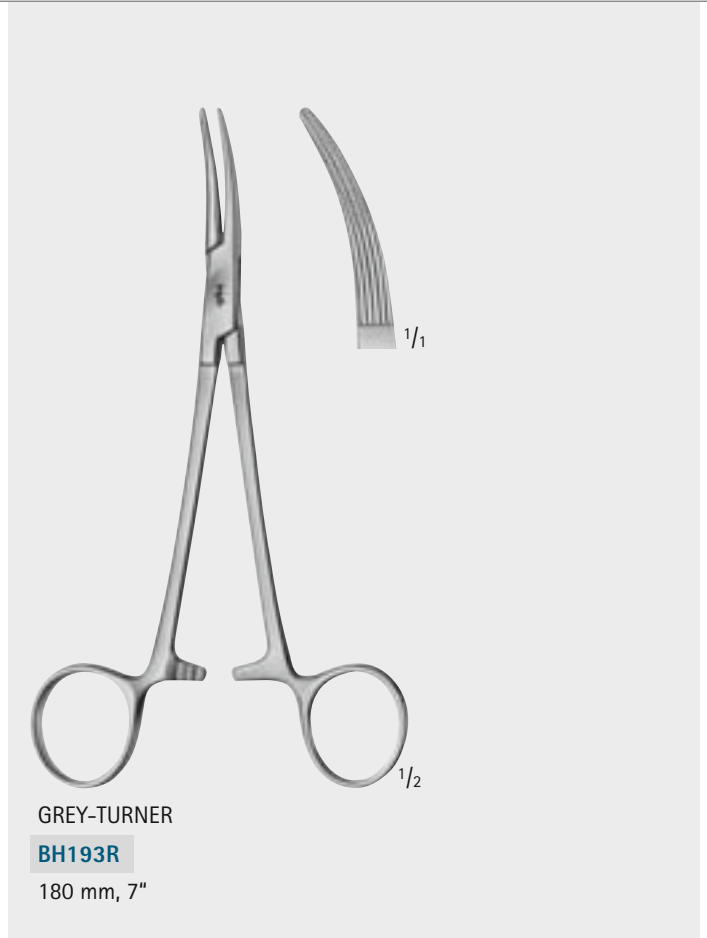
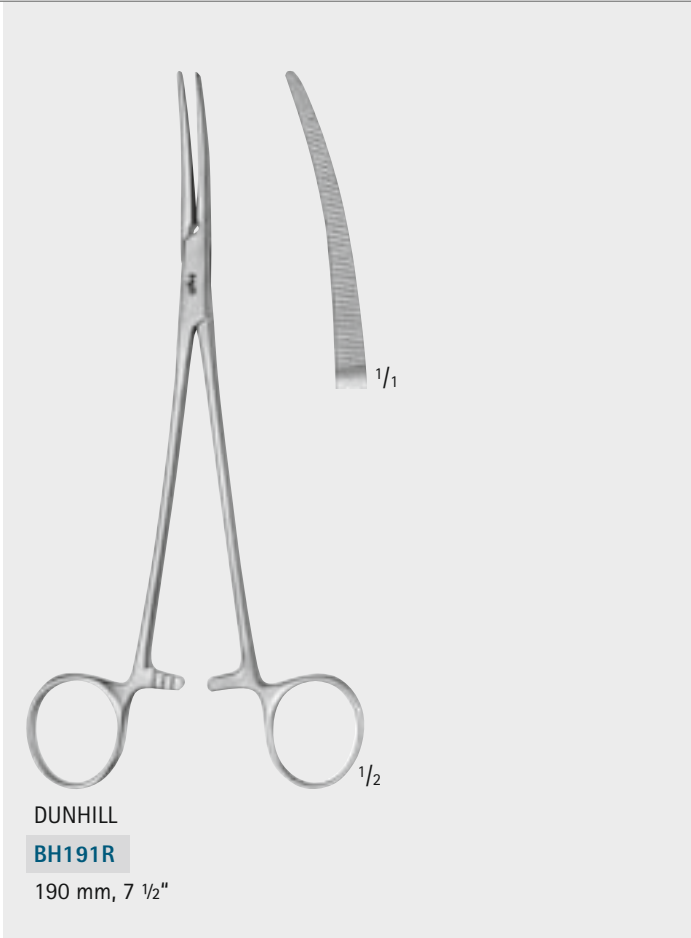

Clips, Clamps – Clips, Klemmen

Hemostatic Forceps

Arterienklemmen

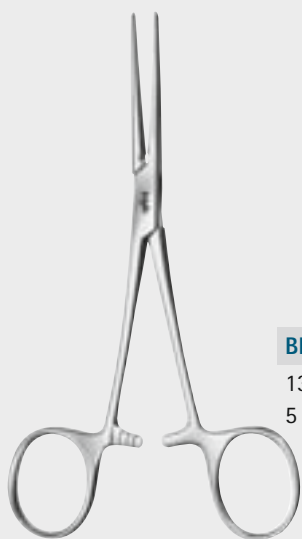
PEAN
BH412R-BH415R

BH412R	BH414R	BH413R	BH415R
130 mm	140 mm	130 mm	140 mm
5 1/8"	5 1/2"	5 1/8"	5 1/2"



PEAN
BH422R-BH425R

BH422R	BH424R	BH425R
130 mm	140 mm	140 mm
5 1/8"	5 1/2"	5 1/2"

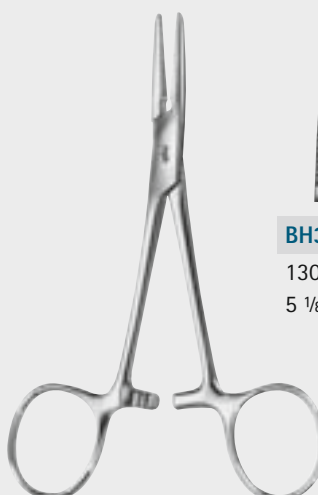

SPENCER-WELLS
BH332R-BH361R

BH332R	BH334R	BH336R	BH338R	BH333R	BH335R	BH337R	BH339R	BH361R
130 mm	150 mm	175 mm	200 mm	130 mm	150 mm	175 mm	200 mm	230 mm
5 1/8"	6"	6 7/8"	7 7/8"	5 1/8"	6"	6 7/8"	7 7/8"	9"

Clips, Clamps – Clips, Klemmen

Hemostatic Forceps

Arterienklemmen

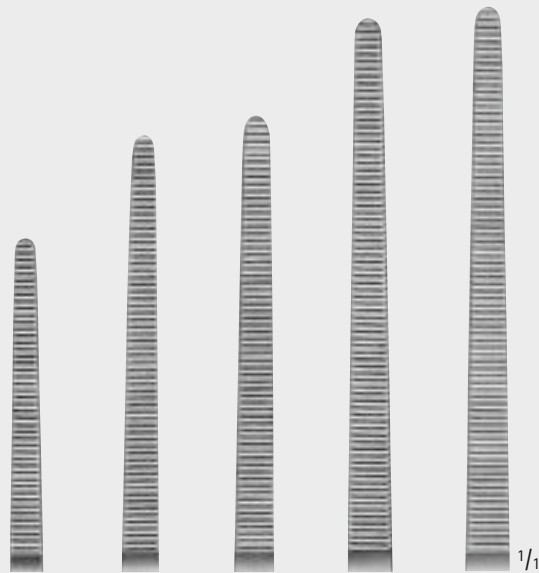

BH442R	BH444R	BH446R	BH448R	BH450R
160 mm 6 1/4"	185 mm 7 1/4"	200 mm 7 7/8"	225 mm 8 7/8"	240 mm 9 1/2"

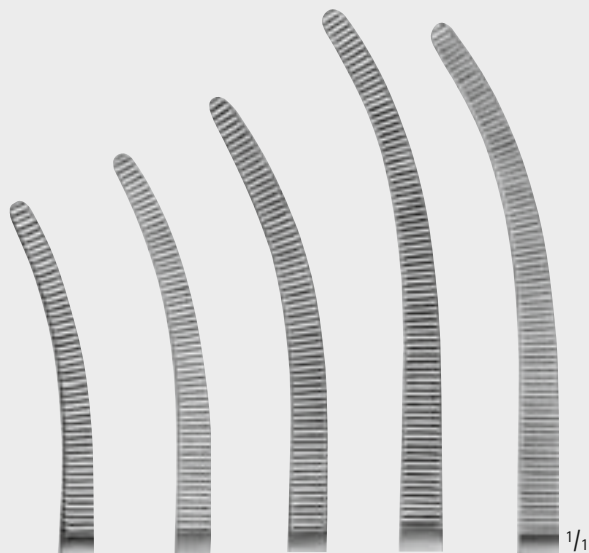

BH443R	BH445R	BH447R	BH449R	BH451R
160 mm 6 1/4"	185 mm 7 1/4"	200 mm 7 7/8"	225 mm 8 7/8"	240 mm 9 1/2"

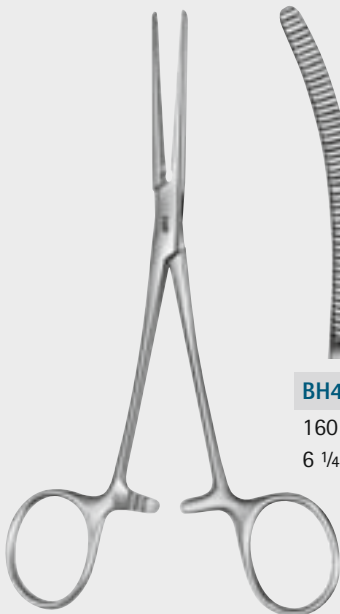

ROCHESTER-PEAN

BH442R-BH451R

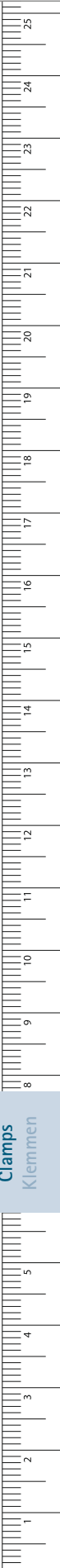

Clips, Clamps – Clips, Klemmen

Hemostatic Forceps

Arterienklemmen

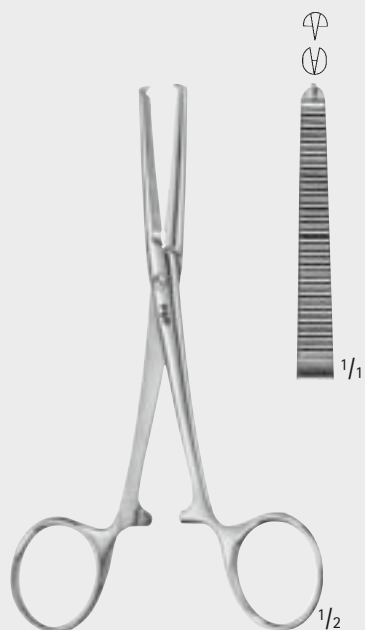

KOCHER
BH610R
 strong pattern
 kräftiges Modell
 145 mm, 5 3/4"

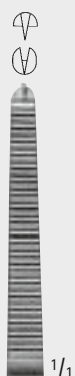

KOCHER
BH612R-BH615R

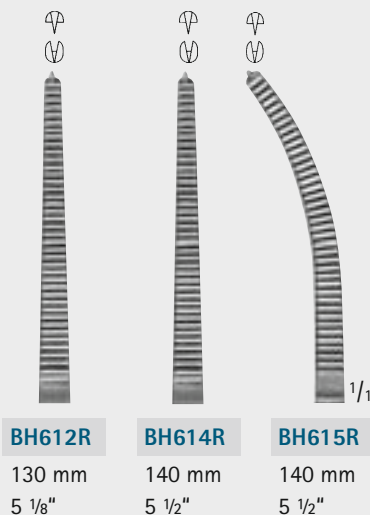

ROCHESTER-OCHSNER
BH618R-BH619R
 140 mm, 5 1/2"

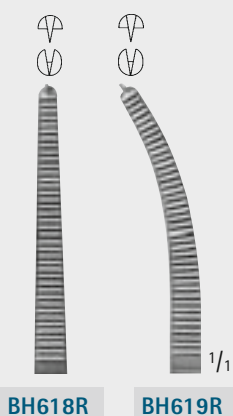

KOCHER
BH630R-BH631R
 150 mm, 6"

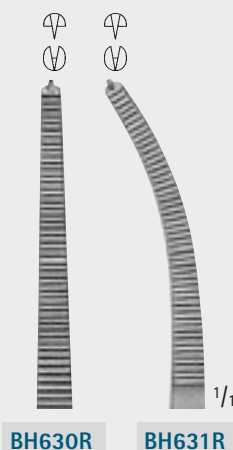

Clamps
Klemmen

Clips, Clamps – Clips, Klemmen

Hemostatic Forceps

Arterienklemmen



BH642R	BH644R	BH646R	BH648R	BH650R
160 mm	185 mm	200 mm	225 mm	240 mm
6 1/4"	7 1/4"	7 7/8"	8 7/8"	9 1/2"

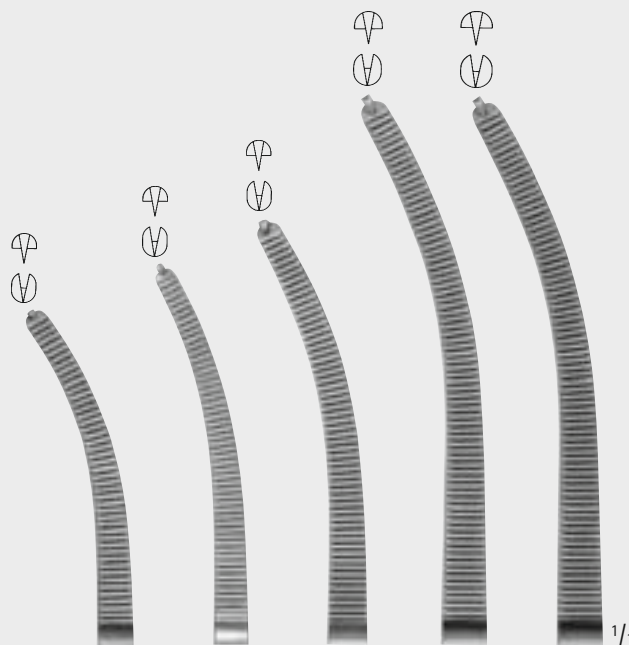

BH643R	BH645R	BH647R	BH649R	BH651R
160 mm	185 mm	200 mm	225 mm	240 mm
6 1/4"	7 1/4"	7 7/8"	8 7/8"	9 1/2"



KOCHER-OCHSNER
BH642R-BH651R

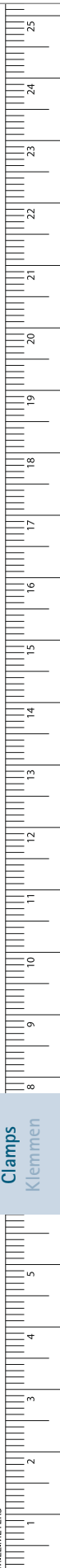

Clamps
Klemmen

Clips, Clamps – Clips, Klemmen

Hemostatic Forceps, Special Patterns

Arterienklemmen, Spezial-Modelle

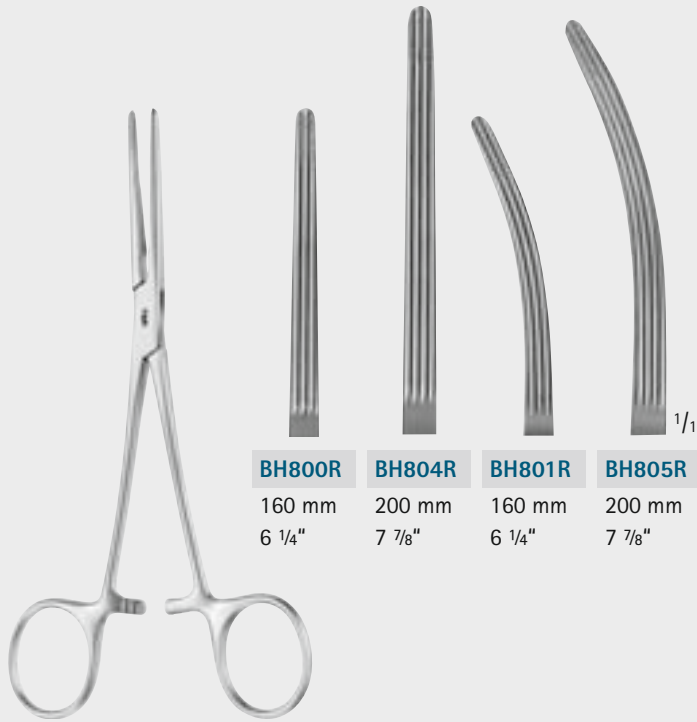

BH800R	BH804R	BH801R	BH805R
160 mm	200 mm	160 mm	200 mm
6 1/4"	7 7/8"	6 1/4"	7 7/8"

ROCHESTER-CARMALT

BH800R-BH805R



BH807R	BH808R

FICKLING

BH807R-BH808R

180 mm, 7"

Clamps
Klemmen

INCHES

Clips, Clamps – Clips, Klemmen
 Hemostatic Forceps, Tonsil Forceps
 Arterienklemmen, Tonsillenklemmen

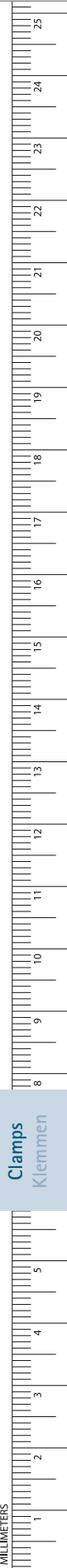
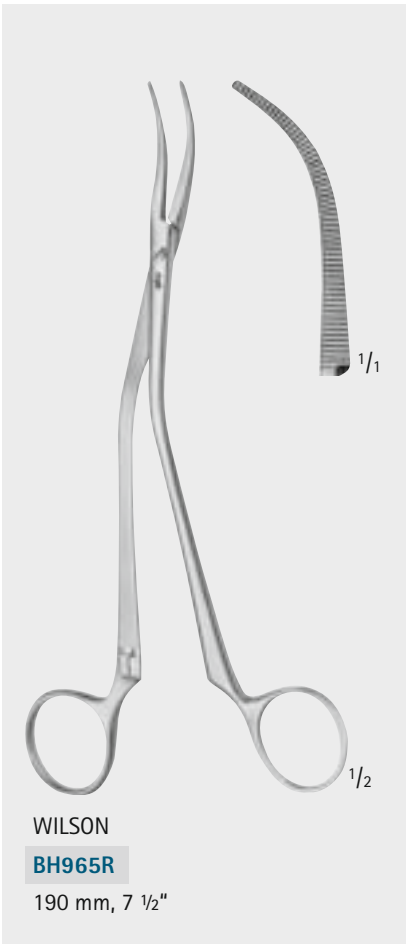
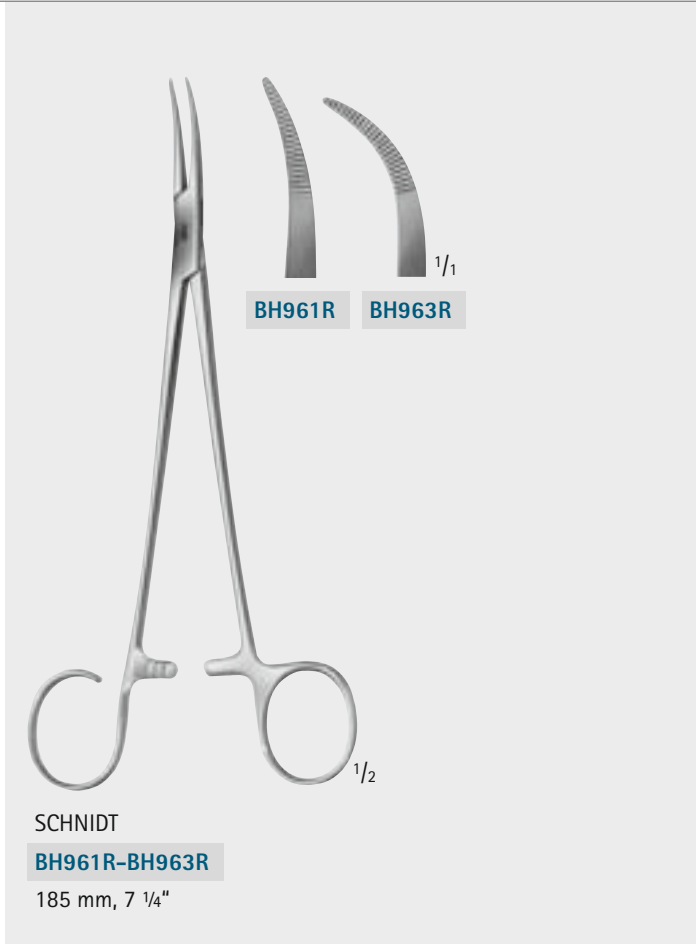
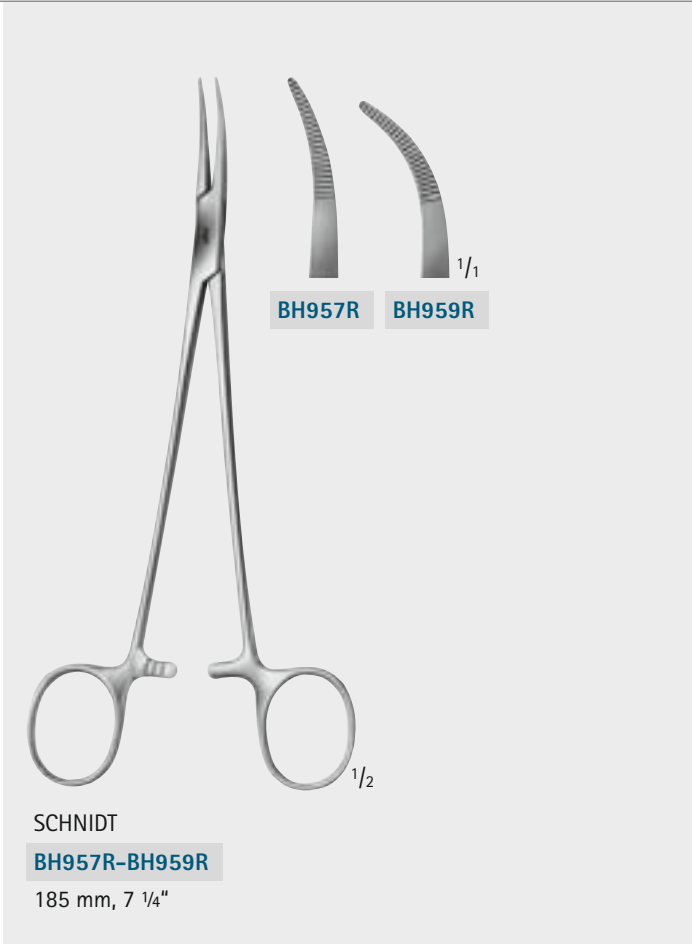

Clips, Clamps – Clips, Klemmen

Dissecting and Ligature Forceps

Präparier- und Ligaturklemmen



1/1
smooth jaw
glattes Maul

BJ002R
95 mm, 3 3/4"



1/1

MICRO-ADSON
BJ008R
140 mm, 5 1/2"



1/1

BABY-OVERHOLT
BJ009R
135 mm, 5 1/4"



BJ011R 140 mm 5 1/2"
BJ012R 180 mm 7"

BABY-MIXTER
BJ011R-BJ012R



BJ097R slightly curved leicht gebogen
BJ098R strong curved stark gebogen

BJ097R-BJ098R
without ratchet
ohne Sperre
140 mm, 5 1/2"

Clips, Clamps – Clips, Klemmen

Dissecting and Ligature Forceps

Präparier- und Ligaturklemmen

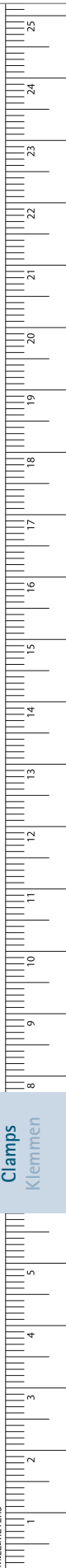
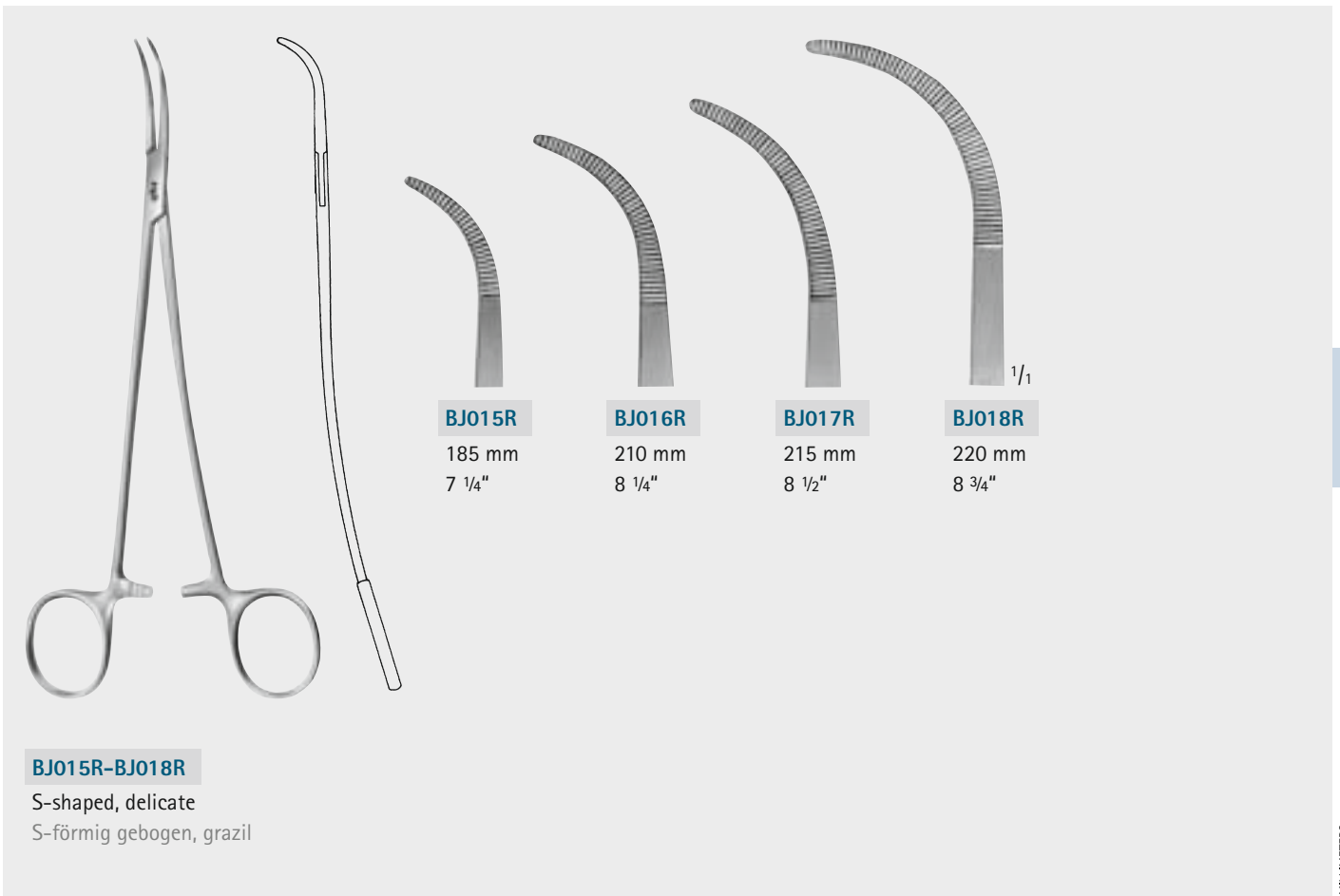
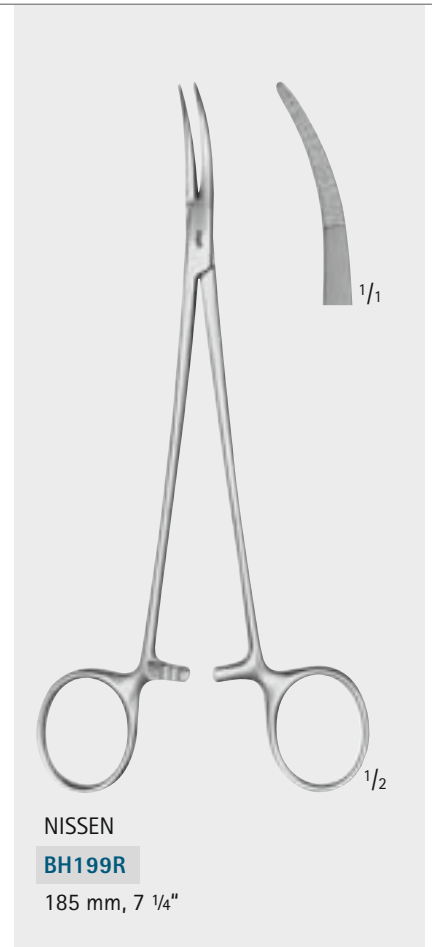

Clips, Clamps – Clips, Klemmen

Dissecting and Ligature Forceps

Präparier- und Ligaturklemmen



OVERHOLT-MIXTER
BJ019R
 205 mm, 8"

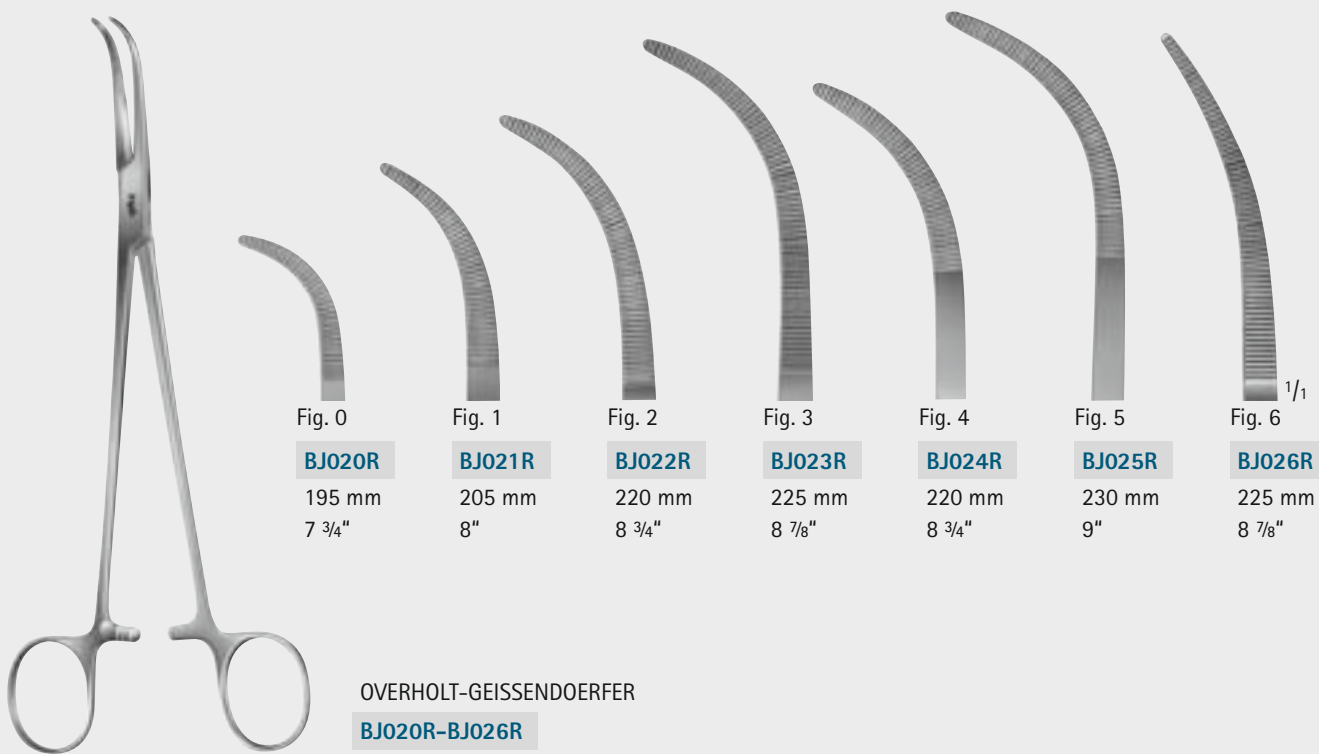

Fig. 0	Fig. 1	Fig. 2	Fig. 3	Fig. 4	Fig. 5	Fig. 6
BJ020R	BJ021R	BJ022R	BJ023R	BJ024R	BJ025R	BJ026R
195 mm 7 3/4"	205 mm 8"	220 mm 8 3/4"	225 mm 8 7/8"	220 mm 8 3/4"	230 mm 9"	225 mm 8 7/8"

OVERHOLT-GEISSENDOERFER
BJ020R-BJ026R

Clips, Clamps – Clips, Klemmen

Dissecting and Ligature Forceps

Präparier- und Ligaturklemmen

OVERHOLT
BJ080R–BJ086R
 delicate pattern
 feine Ausführung

Fig.	Model	Length (mm)	Length (in)
Fig. 0	BJ080R	215 mm	8 1/2"
Fig. 1	BJ081R	210 mm	8 1/4"
Fig. 2	BJ082R	220 mm	8 3/4"
Fig. 3	BJ083R	225 mm	8 7/8"
Fig. 6	BJ086R	225 mm	8 7/8"

GEMINI
BJ100R–BJ103R

Model	Length (mm)	Length (in)
BJ100R	140 mm	5 1/2"
BJ102R	180 mm	7"
BJ103R	200 mm	7 7/8"

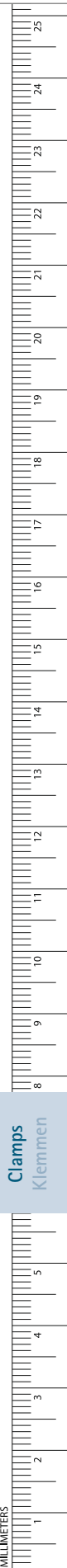

Clamps
Klemmen

MILLIMETERS

Clips, Clamps – Clips, Klemmen

Dissecting and Ligature Forceps

Präparier- und Ligaturklemmen

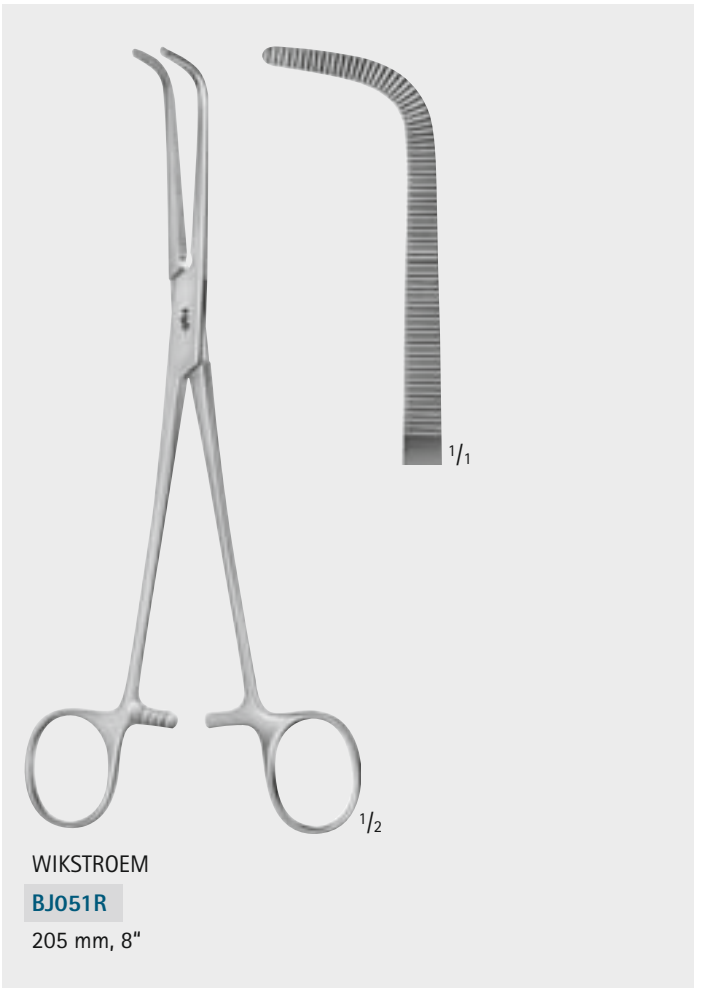
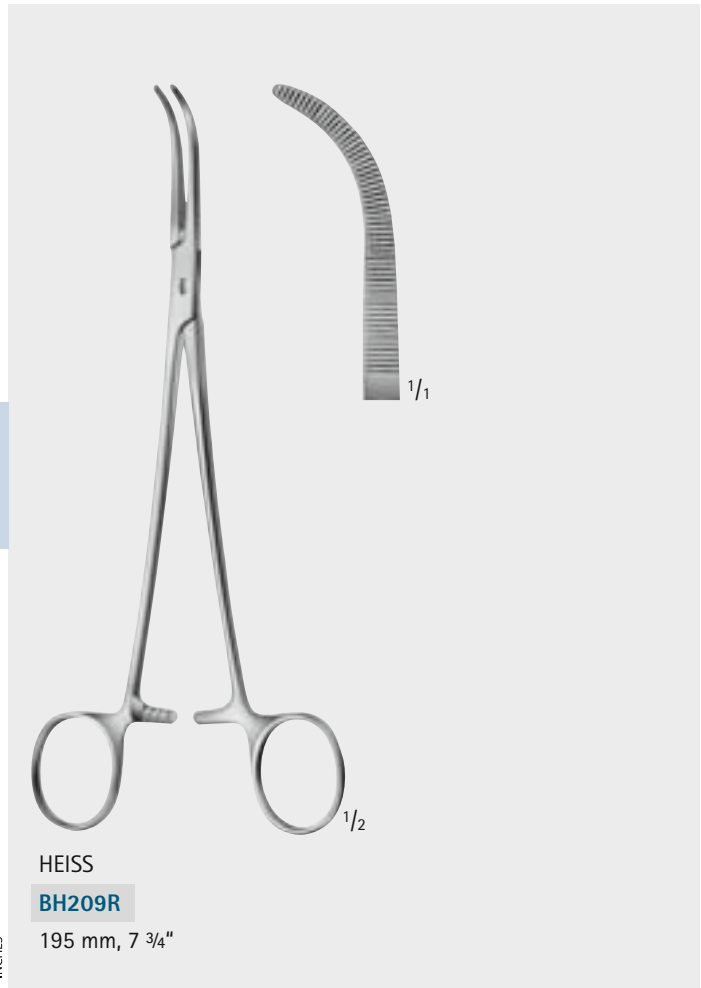
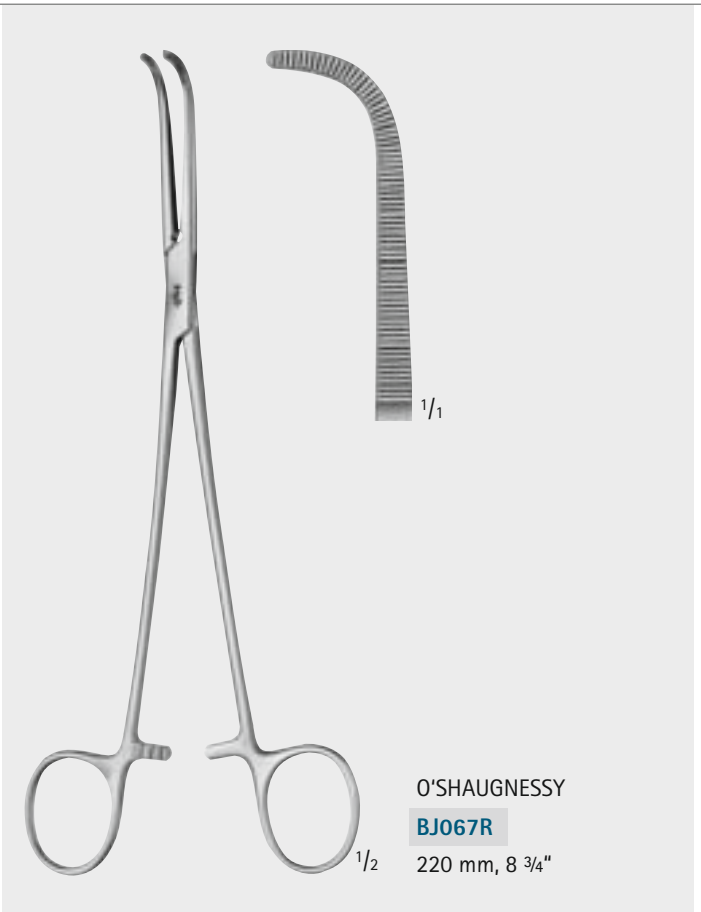
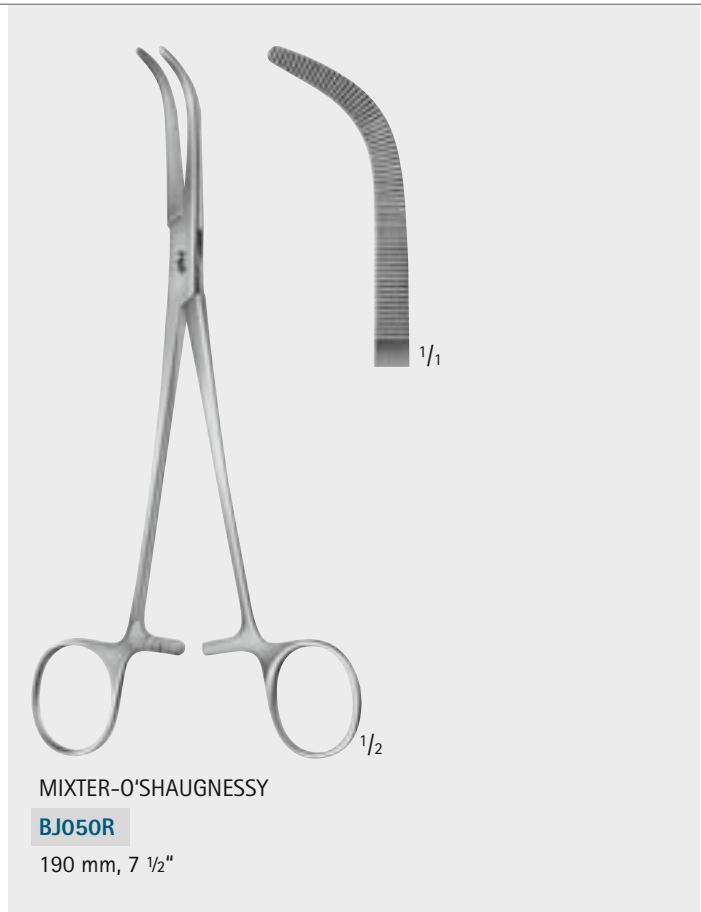

Clamps
Klemmen

Clips, Clamps – Clips, Klemmen

Dissecting and Ligature Forceps

Präparier- und Ligaturklemmen

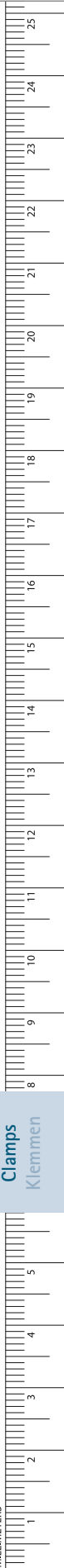
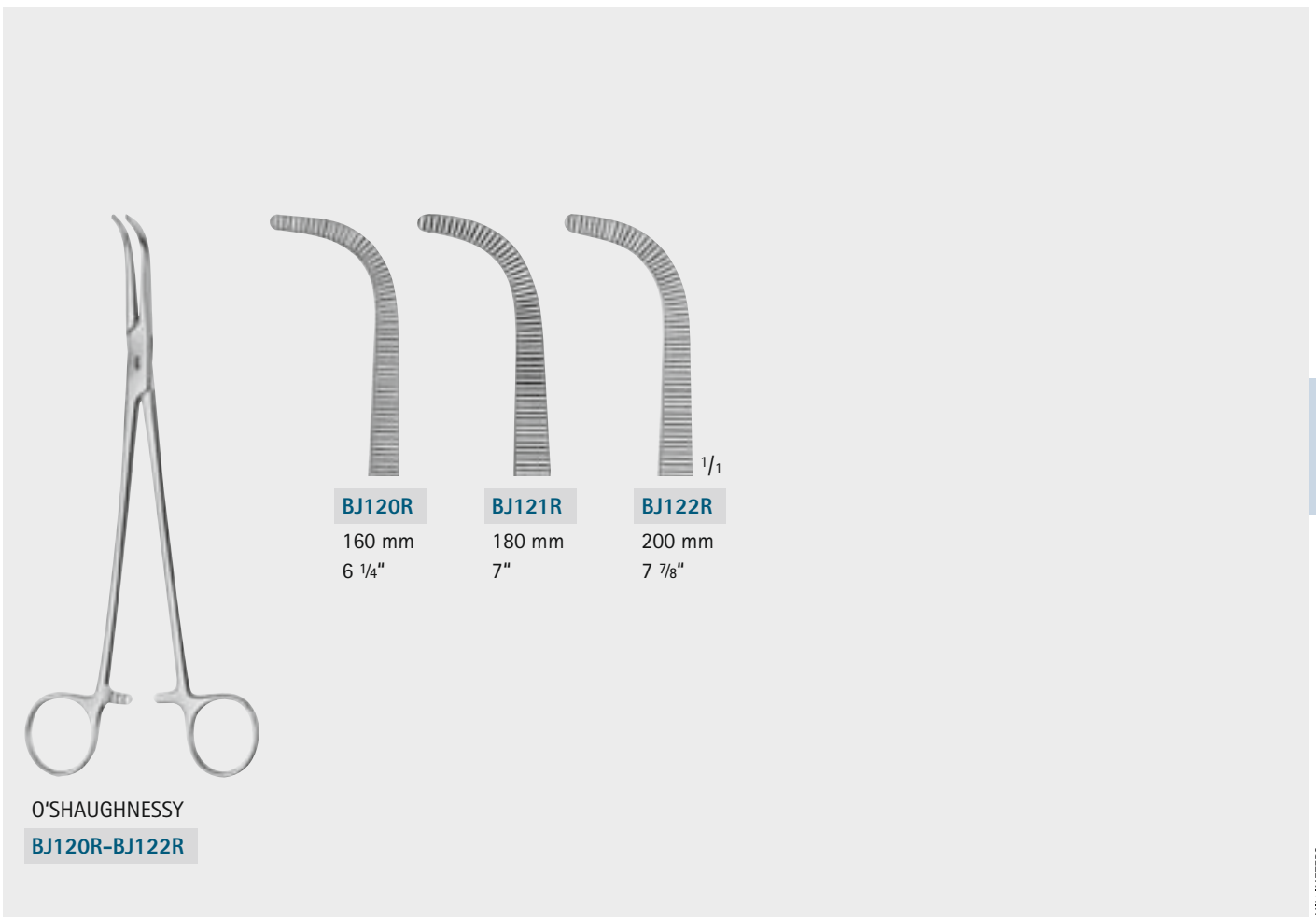
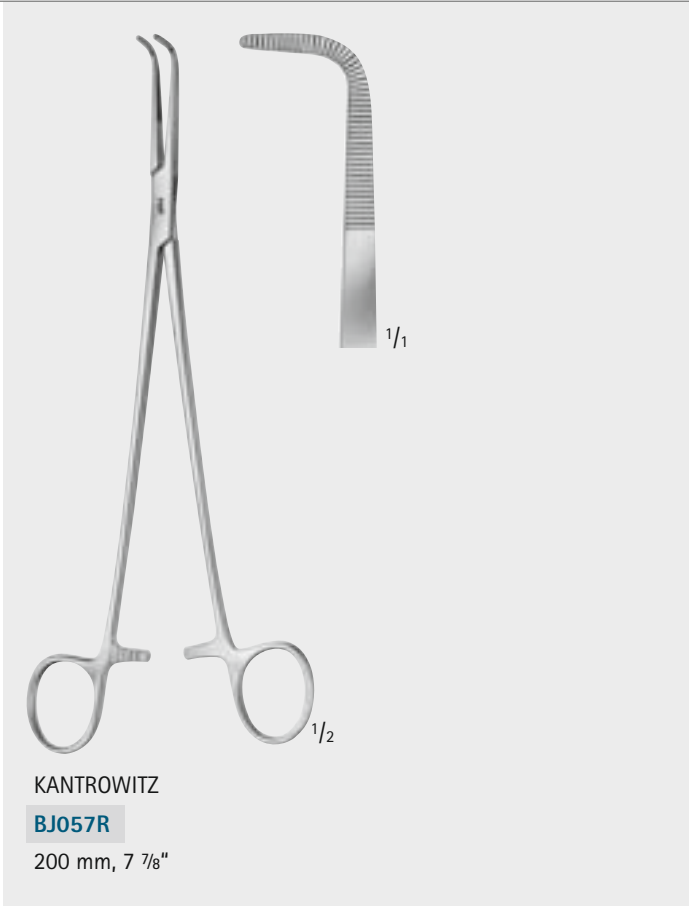

Clips, Clamps – Clips, Klemmen

Dissecting and Ligature Forceps

Präparier- und Ligaturklemmen

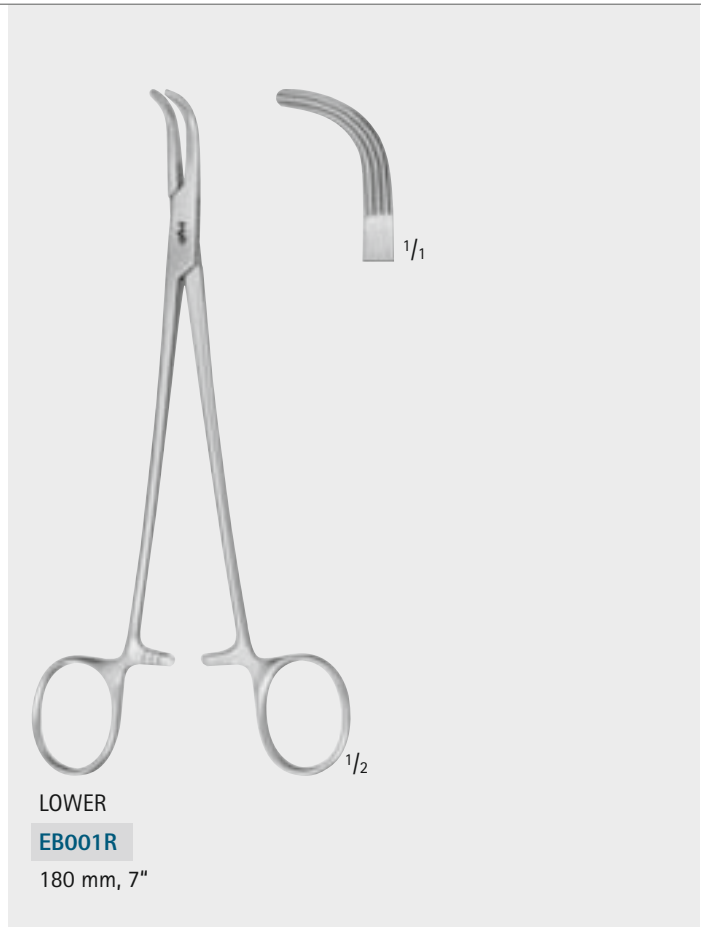

LOWER
EB001R
180 mm, 7"



LAHEY (SWEET)
EB003R
200 mm
7 7/8"

LAHEY
BJ060R
225 mm
8 7/8"

BJ060R, EB003R



MIXTER
BJ061R
220 mm, 8 3/4"

Clamps
Klemmen

Clips, Clamps – Clips, Klemmen

Organ and Tissue Grasping Forceps

Organ- und Gewebefasszangen

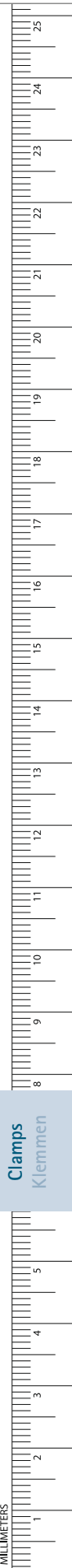
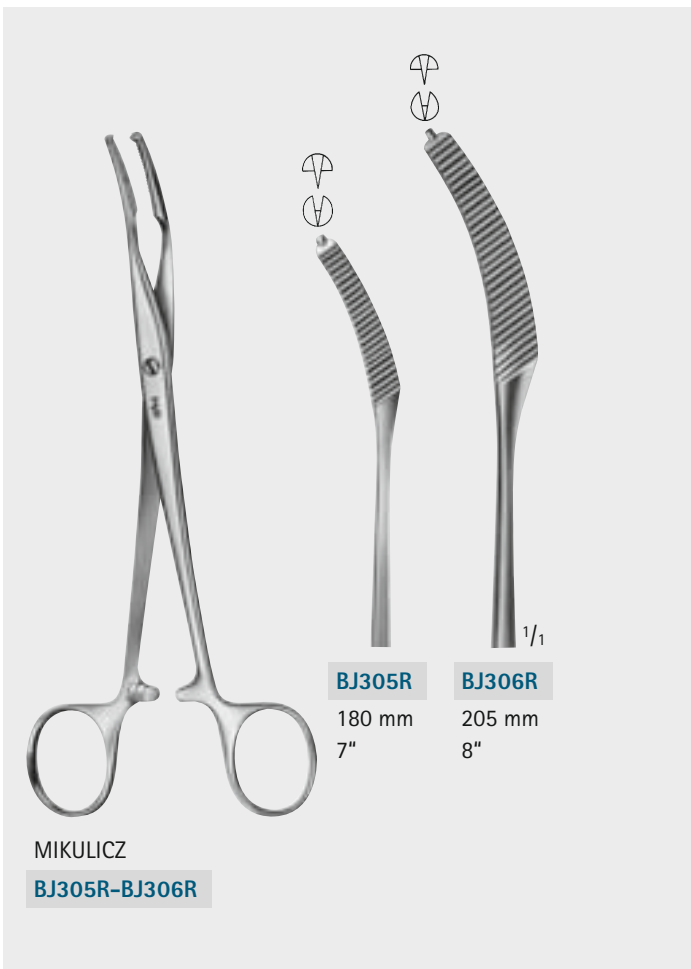
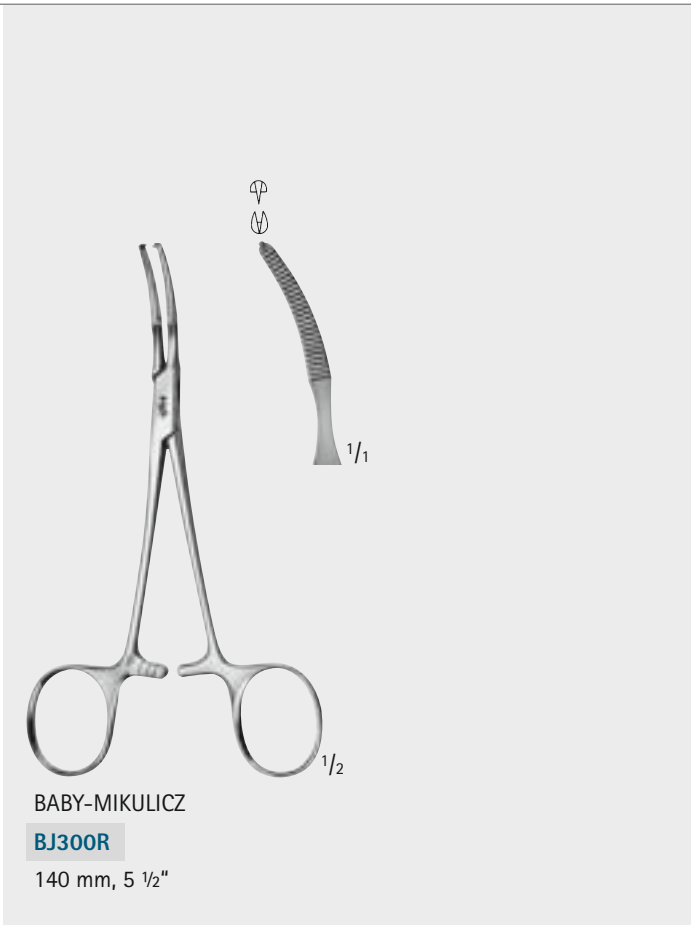

Clips, Clamps – Clips, Klemmen

Organ and Tissue Grasping Forceps

Organ- und Gewebefasszangen



1/1
2 x 3 teeth,
sharp
2 x 3 Zähne,
scharf

1/2

CHAPUT
BF300R
125 mm, 5"

1/1
5 x 6 teeth,
sharp
5 x 6 Zähne,
scharf

1/2

TUFFIER
BF301R
125 mm, 5"

1/1
4 x 5 teeth
4 x 5 Zähne

1/2

BABY-ALLIS
EA012R
130 mm, 5 1/8"

1/1
5 x 6 teeth
5 x 6 Zähne

1/2

BOYS-ALLIS
EA010R
155 mm, 6 1/8"

1/1
9 x 10 teeth
9 x 10 Zähne

1/2

ALLIS-ADAIR
MD568
160 mm, 6 1/4"

Clamps
Klemmen

INCHES

Clips, Clamps – Clips, Klemmen

Organ and Tissue Grasping Forceps

Organ- und Gewebefasszangen

EA013R
2 x 3 teeth
2 x 3 Zähne

EA014R
3 x 4 teeth
3 x 4 Zähne

EA015R
4 x 5 teeth
4 x 5 Zähne

ALLIS
EA013R-EA015R
155 mm, 6 1/8"

EA016R
5 x 6 teeth
5 x 6 Zähne

ALLIS
EA016R
155 mm, 6 1/8"

EA017R
5 x 6 teeth
5 x 6 Zähne

ALLIS
EA017R
190 mm, 7 1/2"

FB938R
5 x 6 teeth
5 x 6 Zähne

ALLIS
FB938R
220 mm, 8 3/4"

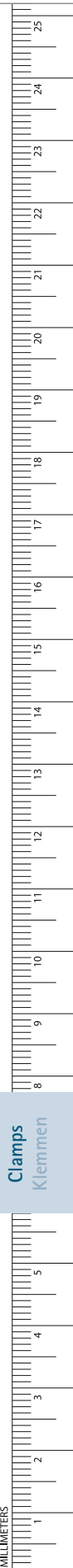

Clips, Clamps – Clips, Klemmen

Organ and Tissue Grasping Forceps

Organ- und Gewebefasszangen



3 x 4 teeth
3 x 4 Zähne

1/1

1/2

JUDD-ALLIS
EA025R
155 mm, 6 1/8"

3 x 4 teeth
3 x 4 Zähne

1/1

1/2

JUDD-ALLIS
EA026R
200 mm, 7 7/8"

6 x 7 teeth
6 x 7 Zähne

1/1

1/2

ALLIS-THOMS
EA020R
200 mm, 7 7/8"

8 mm

1/1

1/2

BABCOCK
EA030R
155 mm, 6 1/8"

8 mm 10 mm 9 mm

1/1

EA031R **EA032R** **EA033R**
175 mm 215 mm 200 mm
6 7/8" 8 1/2" 7 7/8"

BABCOCK
EA031R-EA033R

14 mm

1/1

1/2

BABCOCK
FB934R
220 mm, 8 3/4"

Clamps
Klemmen

Clips, Clamps – Clips, Klemmen

Organ and Tissue Grasping Forceps

Organ- und Gewebefasszangen

■ ATRAUMATA®

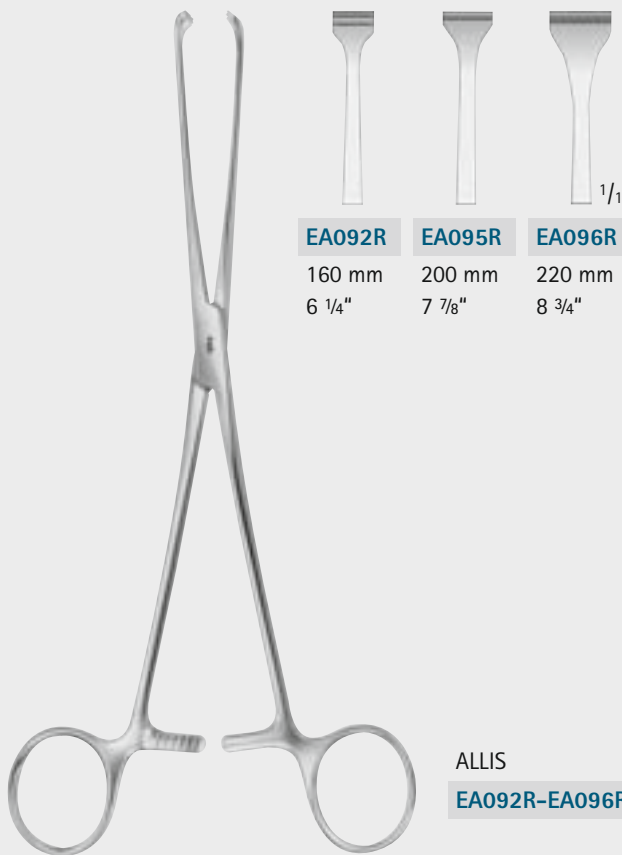

EA092R	EA095R	EA096R
160 mm	200 mm	220 mm
6 1/4"	7 7/8"	8 3/4"

ALLIS
EA092R-EA096R

■ ATRAUMATA®

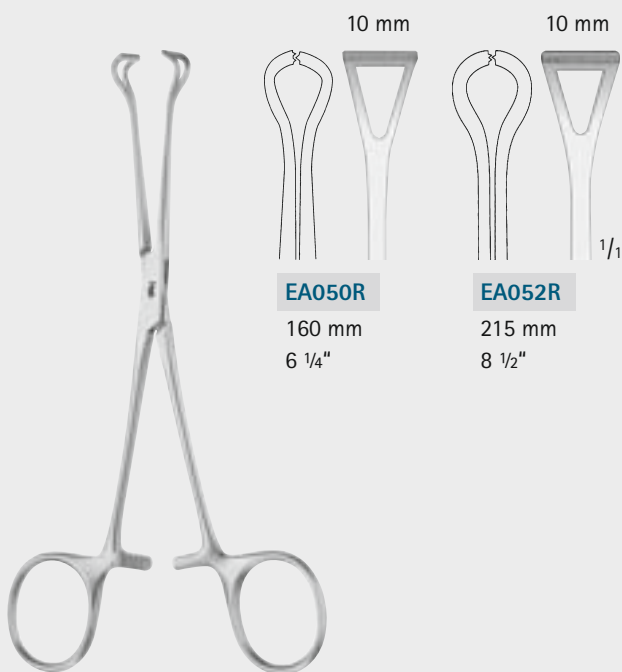

EA050R	EA052R
160 mm	215 mm
6 1/4"	8 1/2"

BABCOCK
EA050R-EA052R

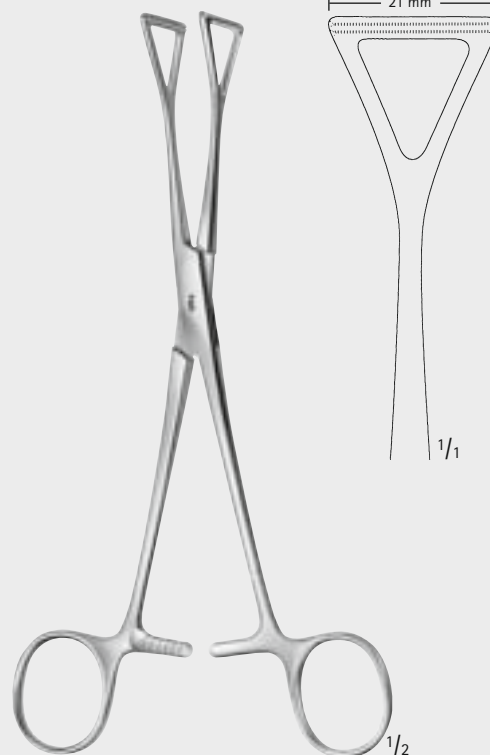

COLLIN
EA061R
195 mm, 7 3/4"

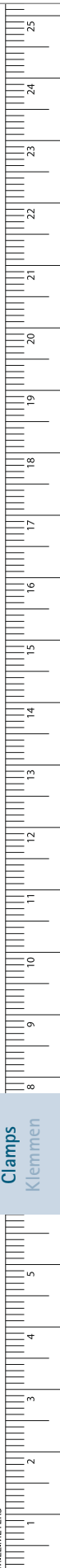

Clips, Clamps – Clips, Klemmen

Organ and Tissue Grasping Forceps

Organ- und Gewebefasszangen



COLLIN
EA039R
140 mm, 5 1/2"

COLLIN
EA040R
180 mm, 7"

LOCKWOOD
EA036R
200 mm, 7 7/8"

EA041R
195 mm
7 3/4"

EA042R
200 mm
7 7/8"

DUVAL-COLLIN
EA041R-EA042R

PENNINGTON
BH902R
155 mm, 6 1/8"

PENNINGTON
EA037R
200 mm, 7 7/8"

Clamps
Klemmen

Clips, Clamps – Clips, Klemmen

Organ and Tissue Grasping Forceps

Organ- und Gewebefasszangen

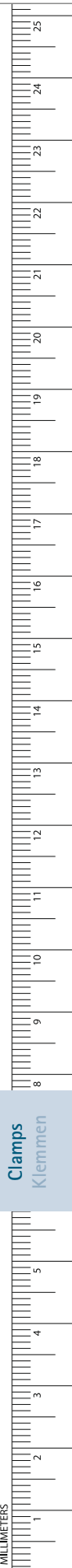
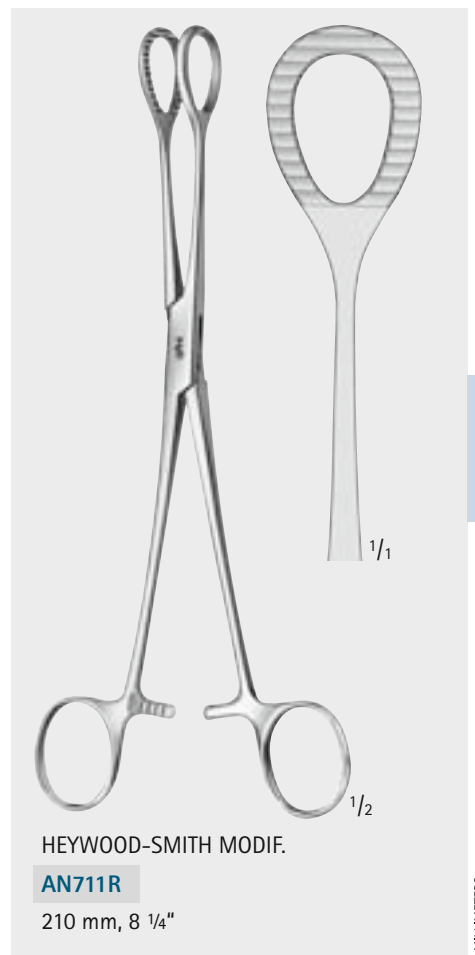
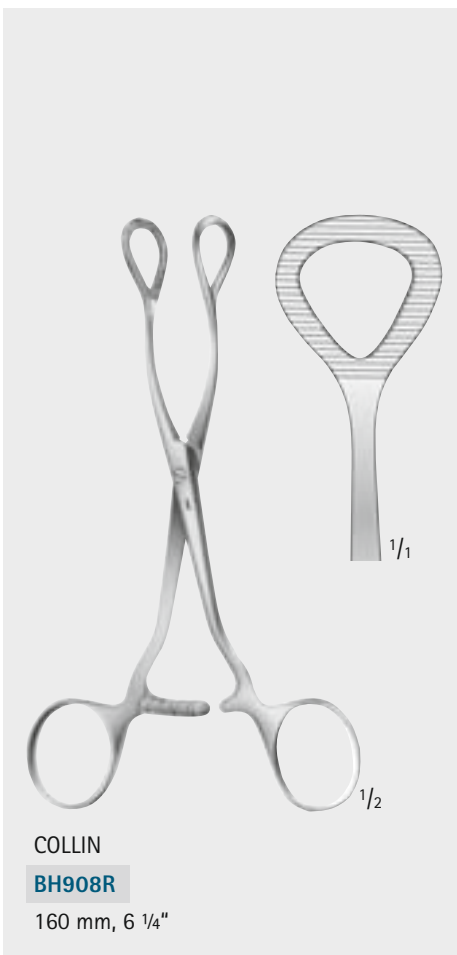
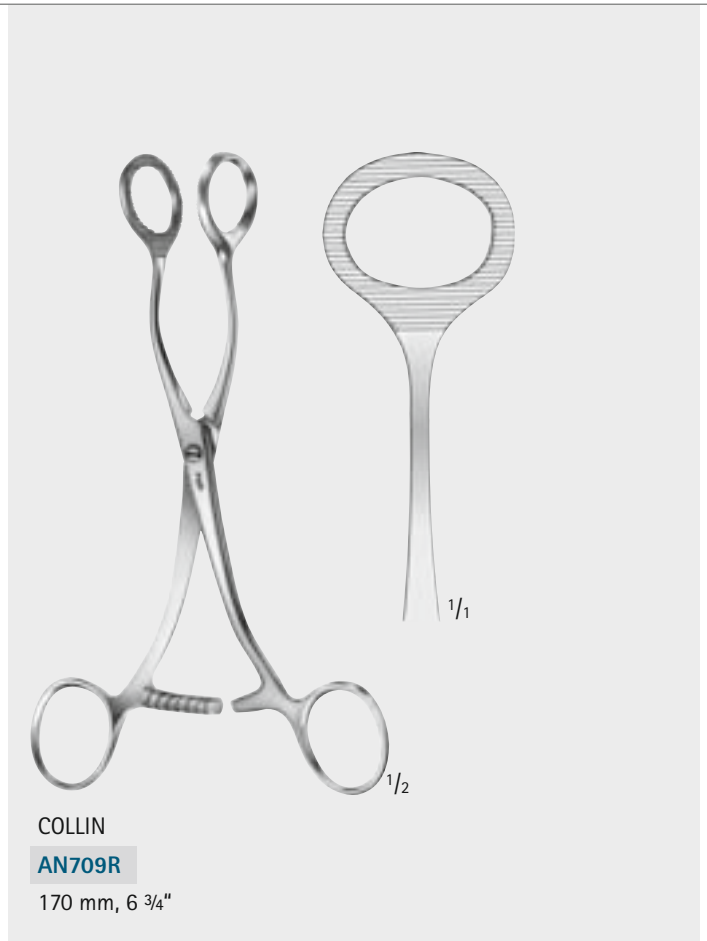
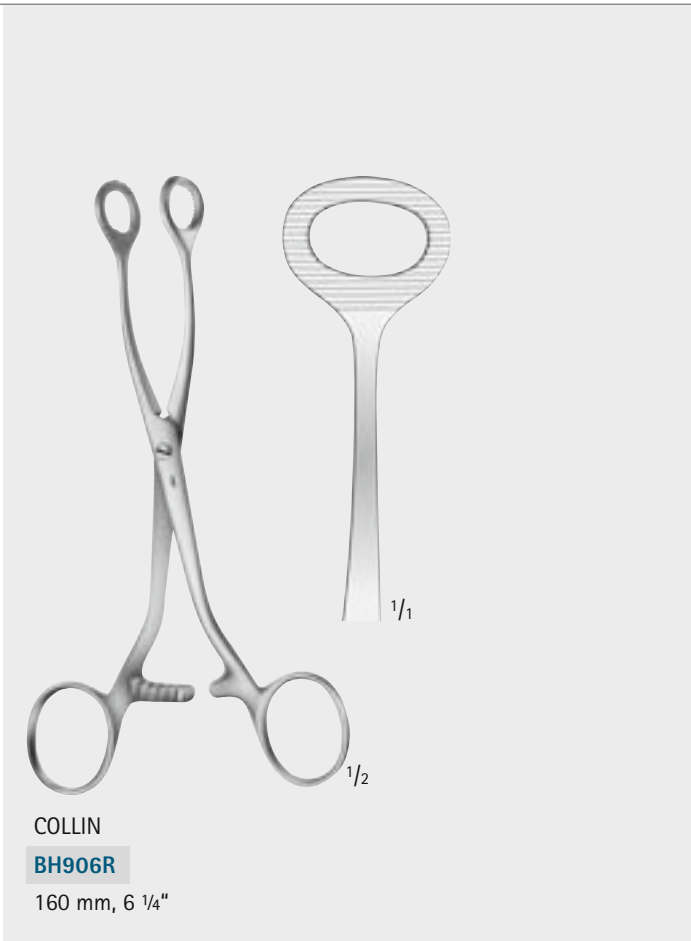

Clips, Clamps – Clips, Klemmen

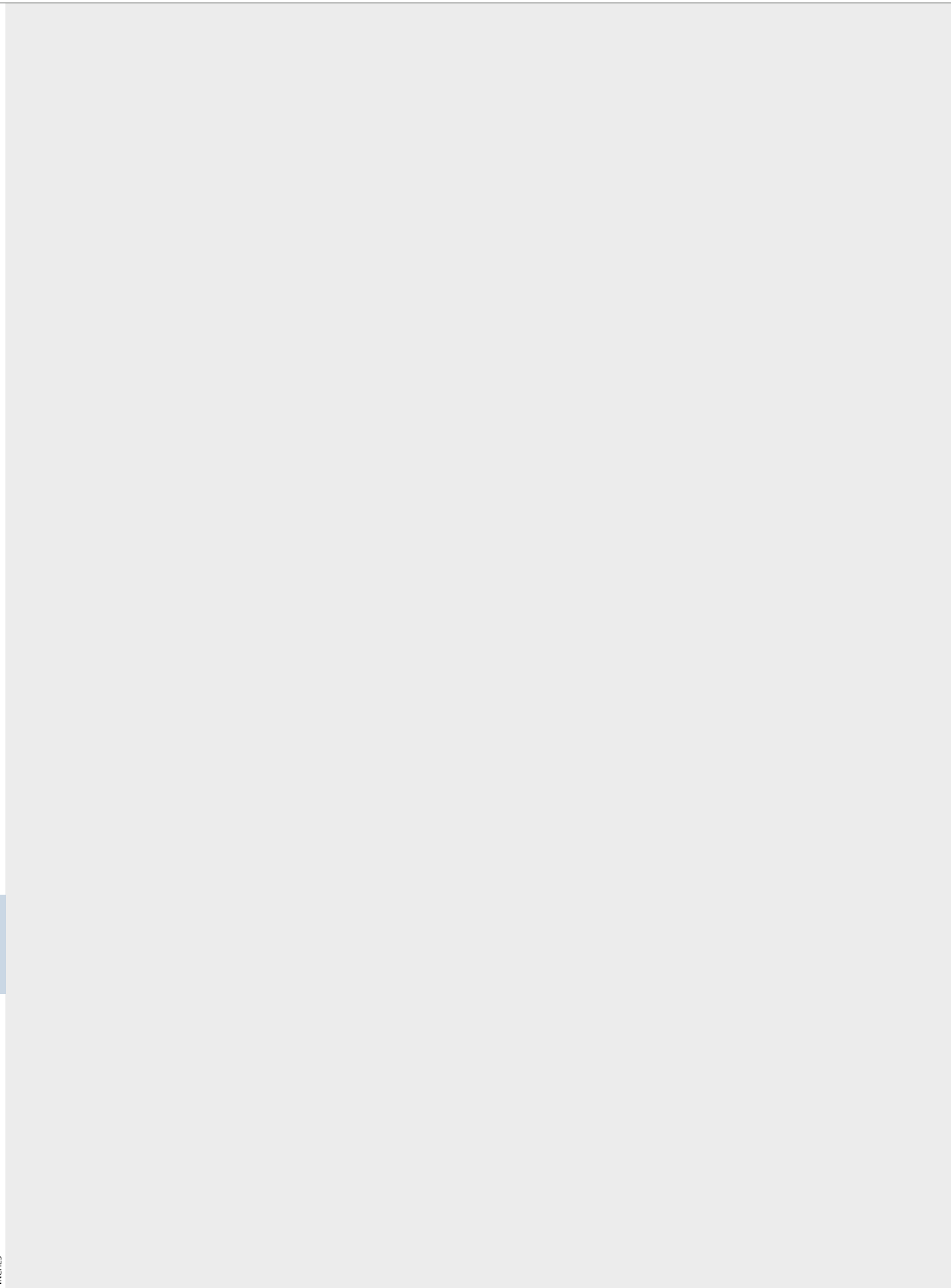

General Surgical Instruments Chirurgische Instrumente

- Needle Holders
- Nadelhalter

Needle Holders, Ligature Instruments – Nadelhalter, Ligatur-Instrumente

DUROGRIP® Needle Holders

DUROGRIP® Nadelhalter

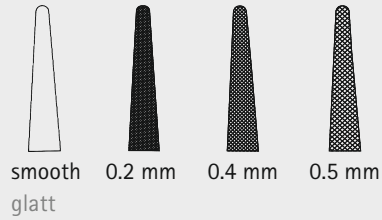
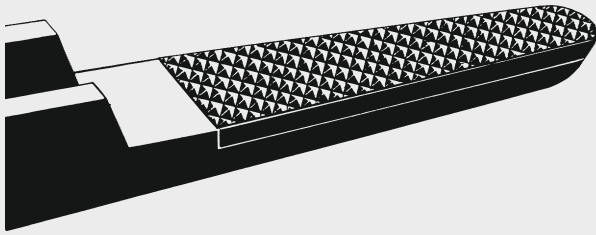

smooth 0.2 mm 0.4 mm 0.5 mm
glatt

- Aesculap needle holders have jaws with tungsten carbide inserts and according to the use required the resp. structure can be chosen. A smooth jaw surface as well as 3 different serrations ensure a sure „grip“ of the resp. needle.
- Aesculap Nadelhalter sind durch die Struktur der Hartmetall-Maulteile auf das jeweilige, indikationsbezogene Nahtmaterial abgestimmt. Eine glatte Maulfläche sowie 3 verschiedene Haftprofile garantieren den sicheren „Grip“ der jeweiligen Nadel.

- We recommend tungsten carbide inserts
 - with smooth jaw surface for suture material 9/0 - 11/0
 - with 0.2 mm pitch of serration for suture material 6/0 - 10/0
 - 0.4 mm 4/0 - 6/0
 - 0.5 mm up to 3/0
- Wir empfehlen Hartmetall-Maulteile
 - mit glatter Fläche für Nahtmaterial 9/0 - 11/0
 - mit Teilung 0,2 mm für Nahtmaterial 6/0 - 10/0
 - 0,4 mm 4/0 - 6/0
 - 0,5 mm bis 3/0

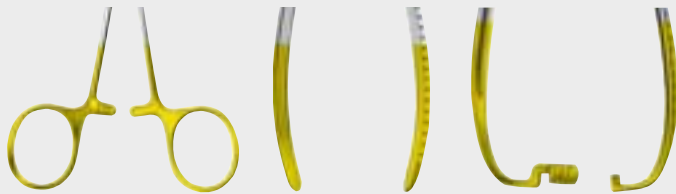

DUROGRIP® Needle holders with tungsten carbide inserts

- Identification:
 - gold-plated rings, handle ends and ratchets
- DUROGRIP® Nadelhalter mit Hartmetall-Plättchen
- Kennzeichnung:
 - Vergoldete Ringe, Branchenenden und Sperren

Needleholders
Nadelhalter

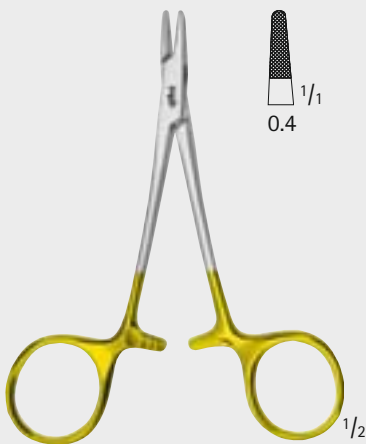

DERF
BM008R
115 mm, 4 1/2"



HALSEY
BM010R
120 mm, 4 3/4"

Needle Holders, Ligature Instruments – Nadelhalter, Ligatur-Instrumente

DUROGRIP® Needle Holders

DUROGRIP® Nadelhalter

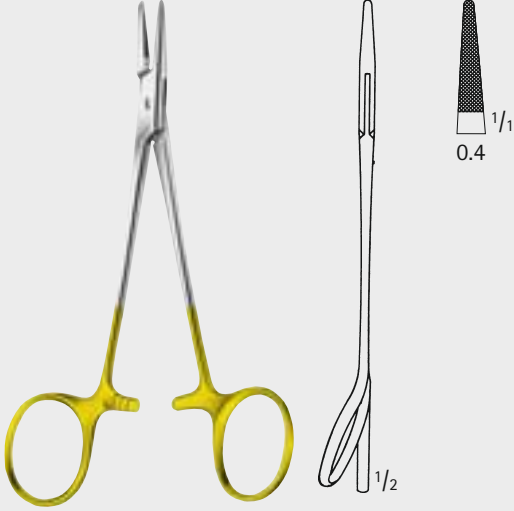

MASING
BM009R
130 mm, 5 1/8"

Technical drawing of the needle holder showing the jaws with a 0.4 mm opening and a 1/1 ratio. A side view of the needle holder is also shown with a 1/2 scale.

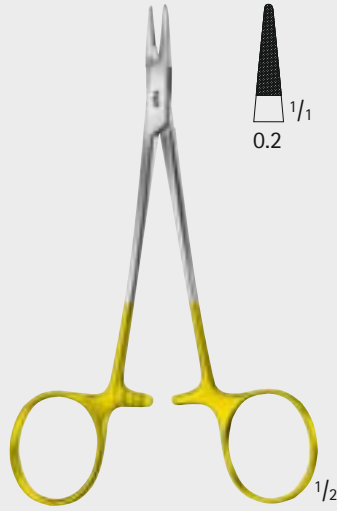

CONVERSE
BM011R
130 mm, 5 1/8"

Technical drawing of the needle holder showing the jaws with a 0.2 mm opening and a 1/1 ratio. A side view of the needle holder is also shown with a 1/2 scale.

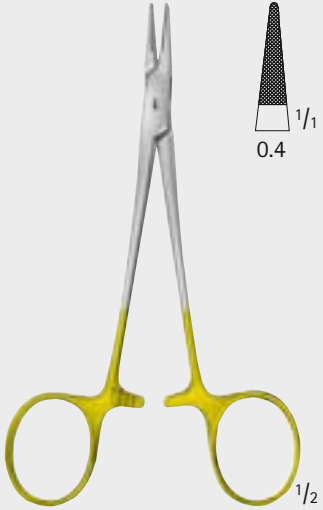

HALSEY
BM012R
130 mm, 5 1/8"

Technical drawing of the needle holder showing the jaws with a 0.4 mm opening and a 1/1 ratio. A side view of the needle holder is also shown with a 1/2 scale.



BM014R
with smooth jaws
mit glattem Maul

BM024R

WEBSTER
BM014R-BM024R
130 mm, 5 1/8"

Technical drawing of the needle holder showing the jaws with a 0.4 mm opening and a 1/1 ratio. A side view of the needle holder is also shown with a 1/2 scale.

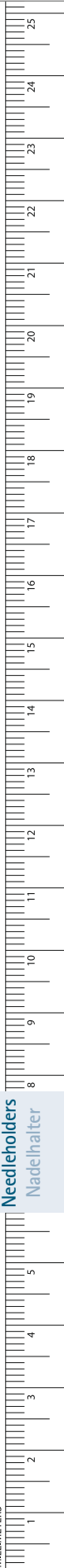

Needle Holders, Ligature Instruments – Nadelhalter, Ligatur-Instrumente

DUROGRIP® Needle Holders

DUROGRIP® Nadelhalter

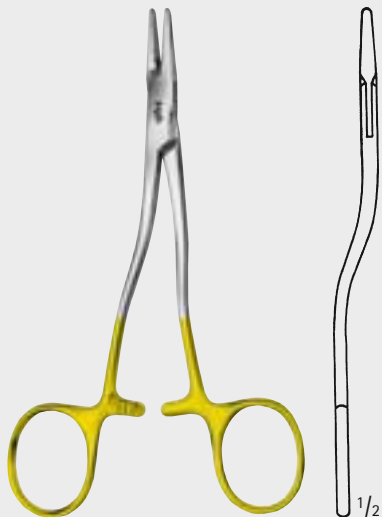
KILNER
BM018R
135 mm, 5 1/4"

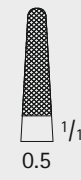

1/1
0.5



BAUMGARTNER
BM015R
145 mm, 5 3/4"



1/1
0.5

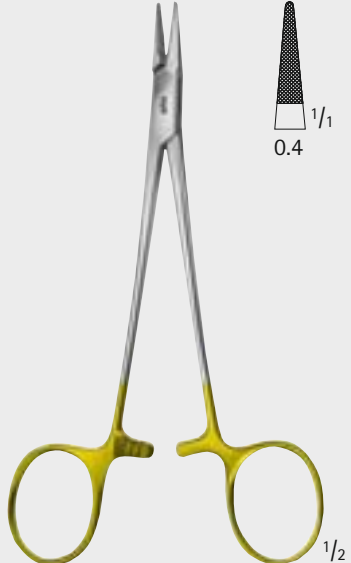

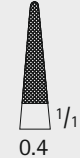

BABY-CRILE-WOOD
BM013R
150 mm, 6"



1/1
0.4



CRILE-WOOD
BM016R-BM019R

		
0.4	0.4	1/1 0.4
BM016R	BM017R	BM019R
145 mm 5 3/4"	185 mm 7 1/4"	200 mm 7 7/8"

Needleholders
Nadelhalter

Needle Holders, Ligature Instruments – Nadelhalter, Ligatur-Instrumente

DUROGRIP® Needle Holders

DUROGRIP® Nadelhalter



Diagram showing two needle holder tips with a 0.4 mm diameter and a 1/1 taper.

BM020R	BM023R
180 mm	260 mm
7"	10 1/4"

SAROT
BM020R-BM023R



Diagram showing a needle holder tip with a 0.4 mm diameter and a 1/1 taper.

HEGAR-MAYO-SEELEY
BM022R
205 mm, 8"

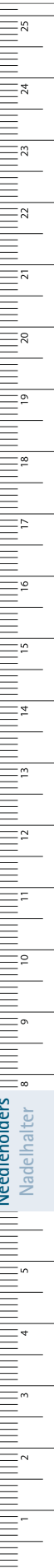

Diagram showing three needle holder tips with a 0.5 mm diameter and a 1/1 taper.

BM065R	BM066R	BM067R
150 mm	185 mm	205 mm
6"	7 1/4"	8"

HEGAR-MAYO
BM065R-BM067R





Needleholders
Nadelhalter

Needle Holders, Ligature Instruments – Nadelhalter, Ligatur-Instrumente

DUROGRIP® Needle Holders

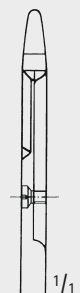
DUROGRIP® Nadelhalter





with smooth jaws
mit glattem Maul

BM127R
125 mm, 5"



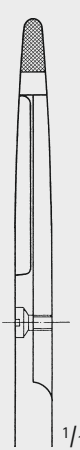

HEGAR-OLSEN MODIF. LANGE
BM128R
145 mm, 5 3/4"

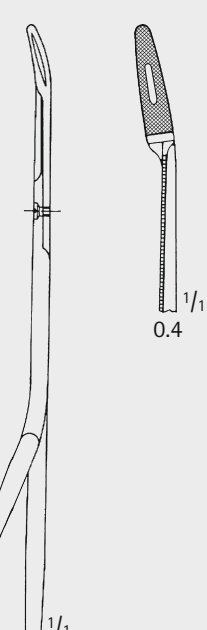

0.4
1 blade fine serrated
1 Blatt fein gezahnt

HEGAR-OLSEN
BM124R
165 mm, 6 1/2"



GILLIES
BM129R
160 mm, 6 1/4"

Needleholders
Nadelhalter

Needle Holders, Ligature Instruments – Nadelhalter, Ligatur-Instrumente

DUROGRIP® Needle Holders

DUROGRIP® Nadelhalter

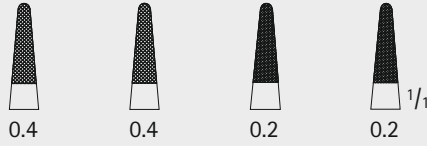

BM033R	BM034R	BM063R	BM064R
165 mm	210 mm	165 mm	210 mm
6 1/2"	8 1/4"	6 1/2"	8 1/4"

DE BAKEY

BM033R-BM064R

very delicate
sehr fein

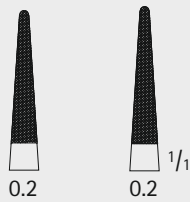

BM025R	BM026R
180 mm	200 mm
7"	7 7/8"

BM025R-BM026R

very delicate
sehr fein

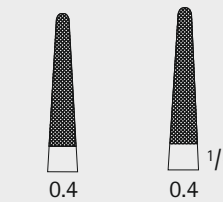

BM032R	BM035R
150 mm	180 mm
6"	7"

DE BAKEY

BM032R-BM035R

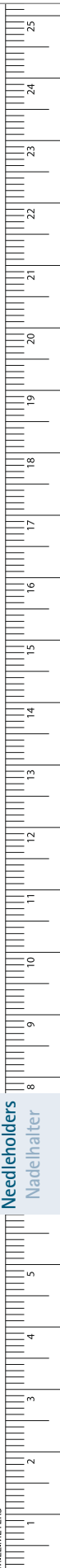

Needleholders
Nadelhalter

MILLIMETERS

Needle Holders, Ligature Instruments – Nadelhalter, Ligatur-Instrumente

DUROGRIP® Needle Holders

DUROGRIP® Nadelhalter

- These special patterns with extremely fine jaws are suitable for holding non-traumatic needles and fine vascular needles.
- Diese Spezialmodelle mit extra schmalen Mäulern eignen sich für atraumatische Nadeln und für feine Gefäßnadeln.



BM074R

150 mm
6"

BM075R

180 mm
7"

RYDER

BM074R-BM075R

with smooth jaws
mit glattem Maul



0.4

BM184R

200 mm, 7 ⁷/₈"

Needle Holders, Ligature Instruments – Nadelhalter, Ligatur-Instrumente

DUROGRIP® Needle Holders

DUROGRIP® Nadelhalter

- These special patterns with extremely fine jaws are suitable for holding non-traumatic needles and fine vascular needles.
- Diese Spezialmodelle mit extra schmalen Mäulern eignen sich für atraumatische Nadeln und für feine Gefäßnadeln.

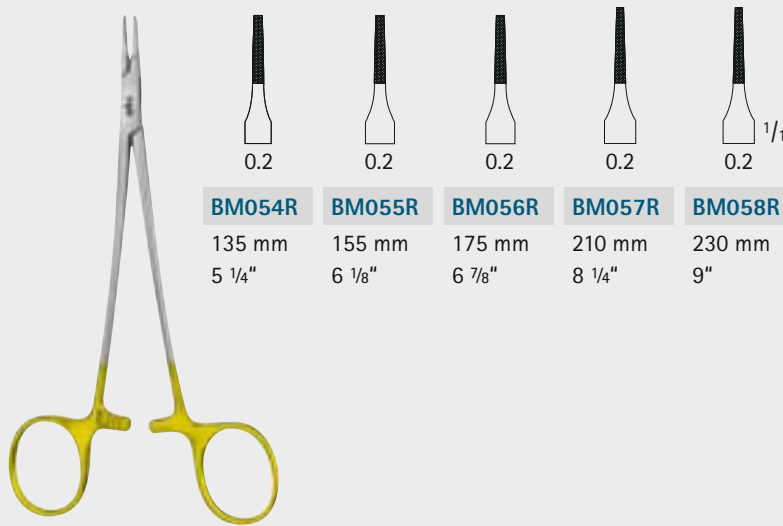

BM054R	BM055R	BM056R	BM057R	BM058R
135 mm	155 mm	175 mm	210 mm	230 mm
5 1/4"	6 1/8"	6 7/8"	8 1/4"	9"

RYDER

BM054R-BM058R

very delicate
sehr fein

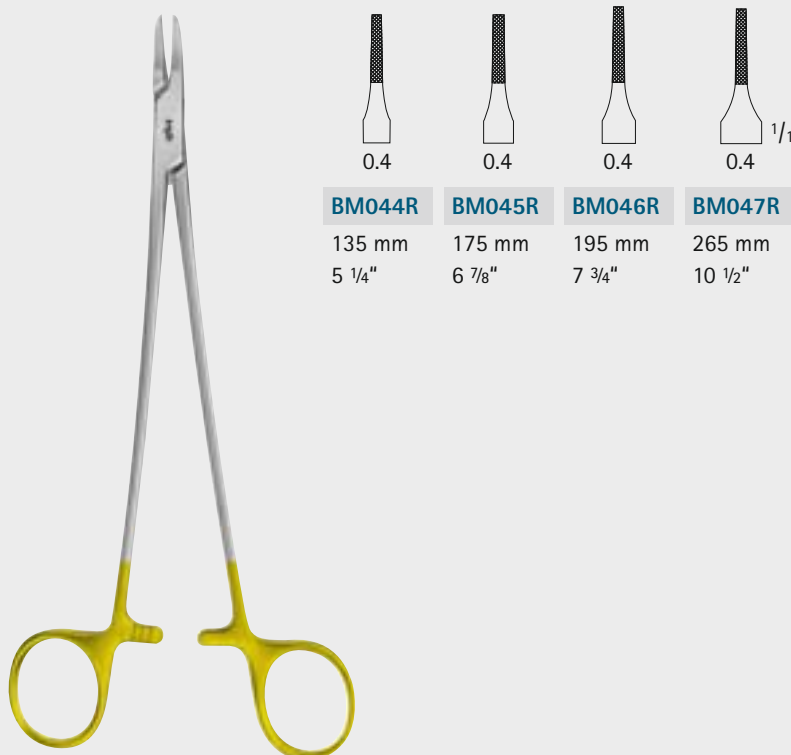

BM044R	BM045R	BM046R	BM047R
135 mm	175 mm	195 mm	265 mm
5 1/4"	6 7/8"	7 3/4"	10 1/2"

RYDER

BM044R-BM047R

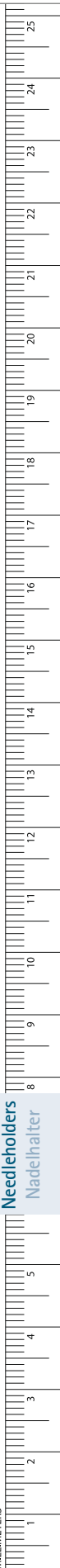

Needleholders
Nadelhalter

MILLIMETERS

Needle Holders, Ligature Instruments – Nadelhalter, Ligatur-Instrumente

Dia Dust® Nadelhalter

Dia Dust® Nadelhalter



■ All needle holder jaws are coated with Aesculap Dia Dust®. This coating ensures that the inner surfaces provide the best possible performance in hardness and wear resistance. The texture of the jaws greatly increases its surface area, allowing you to grasp fine needles safely and securely. The needle quickly aligns itself in an ideal position in the rough surface.

■ Die Dia Dust®-Beschichtung sorgt für eine noch härtere und verschleißfestere Maulinnenfläche. Darüberhinaus unterstützt die Struktur der Dia Dust®-Beschichtung ein zuverlässiges Fassen von feinen Nadeln.

- Titanium
- Titan

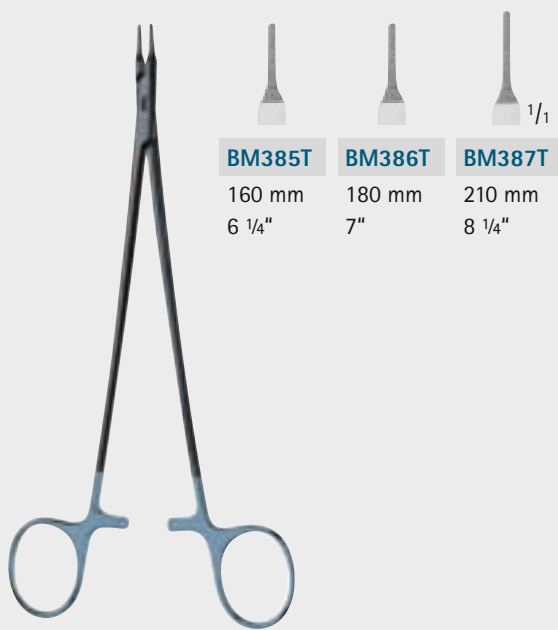

BM385T	BM386T	BM387T
160 mm 6 1/4"	180 mm 7"	210 mm 8 1/4"

RYDER
BM385T-BM387T

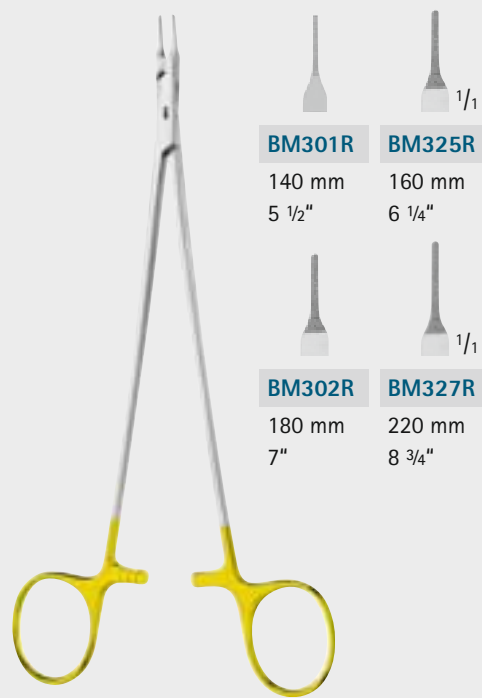

BM301R	BM325R
140 mm 5 1/2"	160 mm 6 1/4"
BM302R	BM327R
180 mm 7"	220 mm 8 3/4"

RYDER
BM301R-BM327R

Needleholders
Nadelhalter

INCHES

Needle Holders, Ligature Instruments – Nadelhalter, Ligatur-Instrumente

DUROGRIP® Needle Holders

DUROGRIP® Nadelhalter



Diagram of the needle holder tip showing a 1/1 ratio and a 0.5 mm thickness. The handle has a yellow elastic grip with a 1/2 inch section.

TÖNNIS
BM186R
 elastic pattern
 elastisches Modell
 180 mm, 7"



Diagram of the needle holder tip showing a 1/1 ratio and a 0.5 mm thickness. The handle has a yellow elastic grip with a 1/2 inch section.

TÖNNIS MODIF.
BM183R
 elastic pattern
 elastisches Modell
 180 mm, 7"



Diagram of the needle holder tip showing a 1/1 ratio and a 0.5 mm thickness. The handle has a yellow elastic grip with a 1/2 inch section.

LANGENBECK
BM191R-BM193R

BM191R	BM193R
180 mm	200 mm
7"	7 7/8"

■ grazil

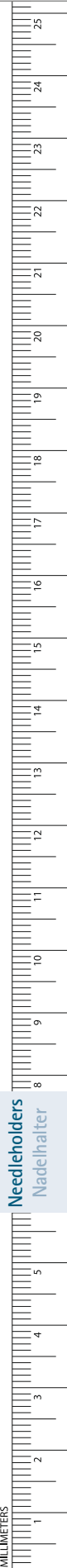

Diagram of the needle holder tip showing a 1/1 ratio and a 0.4 mm thickness. The handle has a yellow elastic grip with a 1/2 inch section.

LANGENBECK
BM196R
 200 mm, 7 7/8"



Needle Holders, Ligature Instruments – Nadelhalter, Ligatur-Instrumente

DUROGRIP® Needle Holders

DUROGRIP® Nadelhalter



Model	Length (mm)	Length (inches)
BM148R	140 mm	5 1/2"
BM150R	170 mm	6 1/2"
BM153R	200 mm	7 7/8"

MATHIEU
BM148R-BM153R
 delicate patterns
 feine Modelle

Model	Length (mm)	Length (inches)
BM149R	140 mm	5 1/2"
BM151R	170 mm	6 1/2"
BM154R	200 mm	7 7/8"

MATHIEU
BM149R-BM154R
 Standard patterns
 Standard-Modelle

■ grazil

LICHTENBERG
BM132R
 elastic pattern
 elastisches Modell
 195 mm, 7 3/4"

HÖSEL
BM165R
 with long neck
 mit langem Hals
 205 mm, 8"

Needle Holders, Ligature Instruments – Nadelhalter, Ligatur-Instrumente

Ligature Needles

Unterbindungsnadeln



KRONECKER

BM801R

for right hand
blunt
für rechte Hand
stumpf
155 mm, 6 1/8"



KRONECKER

BM802R

for left hand
blunt
für linke Hand
stumpf
155 mm, 6 1/8"



DESCHAMPS

BM810R

for right hand
blunt
für rechte Hand
stumpf
215 mm, 8 1/2"



DESCHAMPS

BM811R

for left hand
blunt
für linke Hand
stumpf
215 mm, 8 1/2"

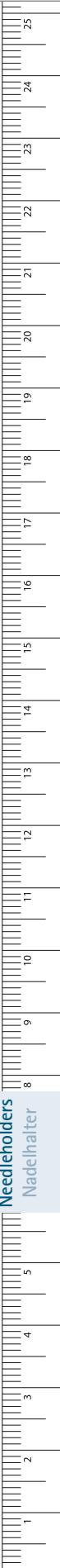

Needle Holders, Ligature Instruments – Nadelhalter, Ligatur-Instrumente

Ligature Needles

Unterbindungsnadeln



Needleholders
Nadelhalter



DESCHAMPS
BM806R
for right hand
blunt
für rechte Hand
stumpf
215 mm, 8 1/2"

DESCHAMPS
BM807R
for left hand
blunt
für linke Hand
stumpf
215 mm, 8 1/2"

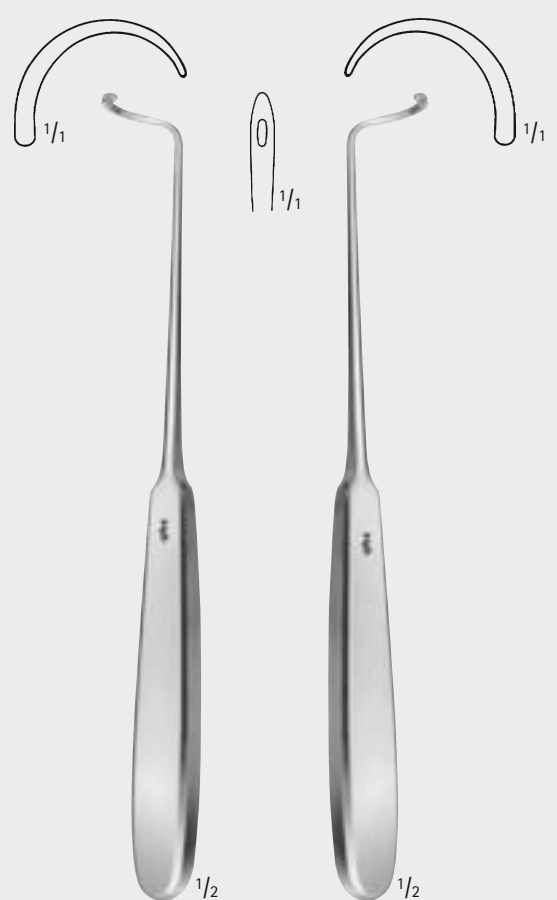

DESCHAMPS
BM808R
for right hand
blunt
für rechte Hand
stumpf
210 mm, 8 1/4"

DESCHAMPS
BM809R
for left hand
blunt
für linke Hand
stumpf
210 mm, 8 1/4"

Needle Holders, Ligature Instruments – Nadelhalter, Ligatur-Instrumente

Ligature Needles

Unterbindungsnadeln

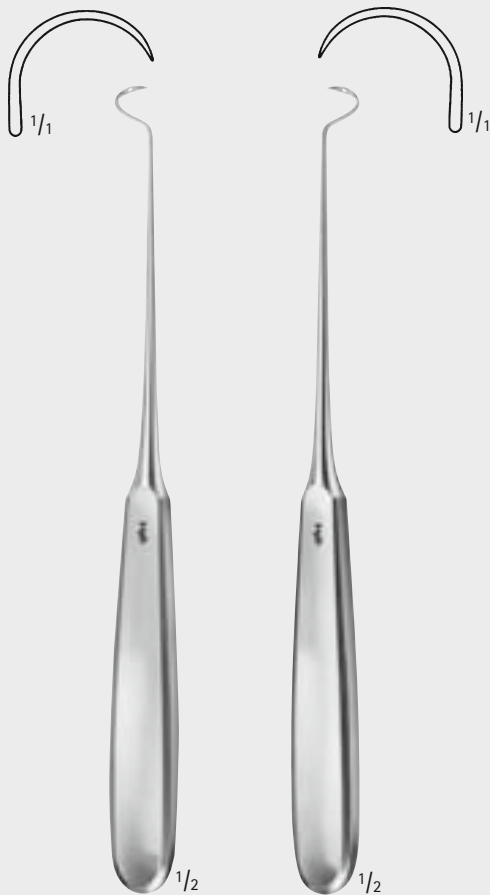

HURD
BM770R
 for right hand
 sharp
 für rechte Hand
 scharf
 210 mm, 8 1/4"

HURD
BM771R
 for left hand
 sharp
 für linke Hand
 scharf
 210 mm, 8 1/4"



DESCHAMPS
BM780R
 for right hand
 sharp
 für rechte Hand
 scharf
 210 mm, 8 1/4"

DESCHAMPS
BM781R
 for left hand
 sharp
 für linke Hand
 scharf
 210 mm, 8 1/4"

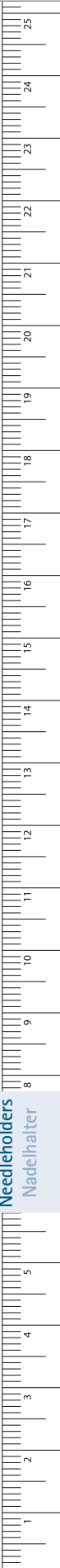

Needle Holders, Ligature Instruments – Nadelhalter, Ligatur-Instrumente

Guiding Probes

Führungshohlsonden

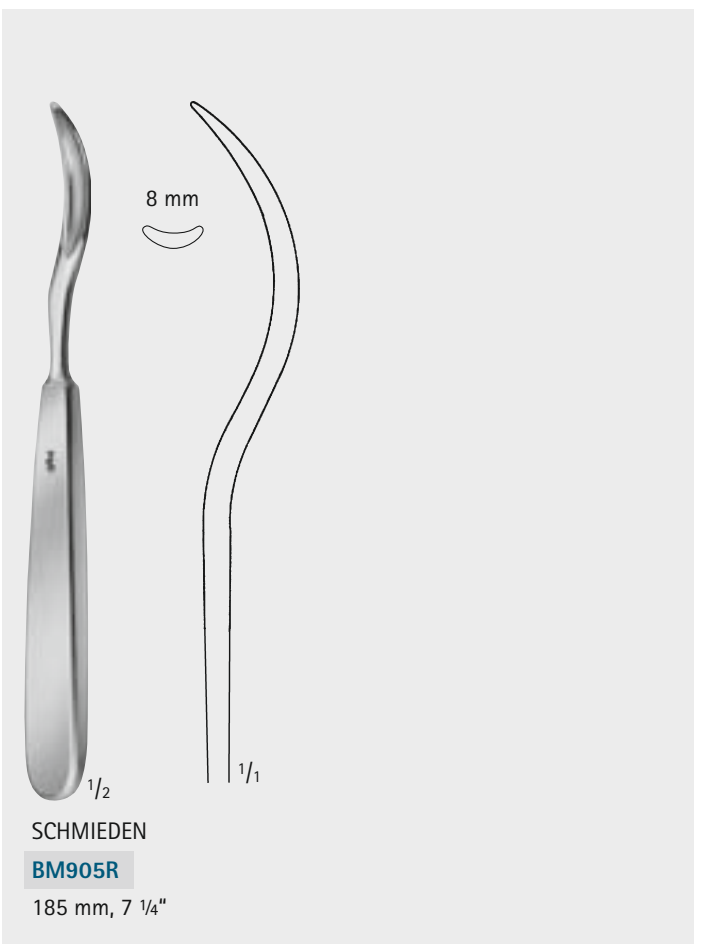
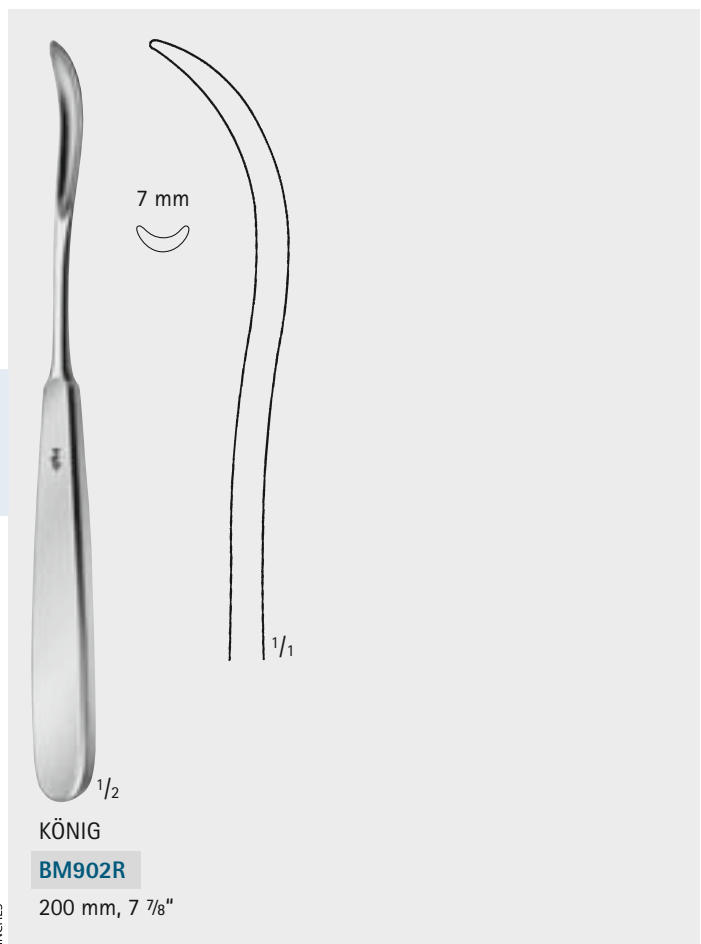
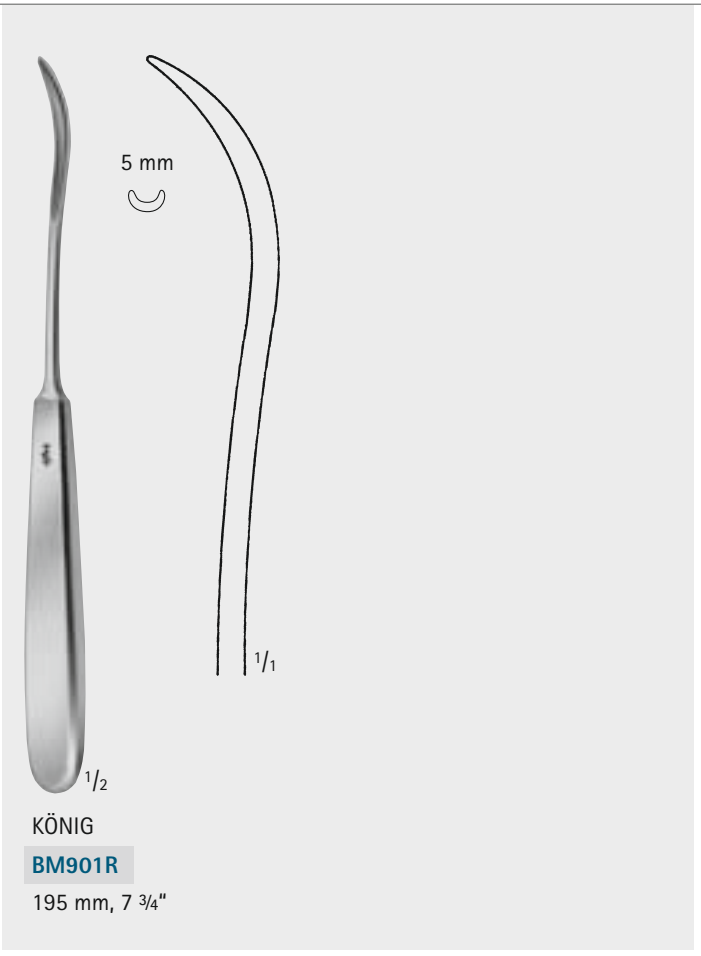
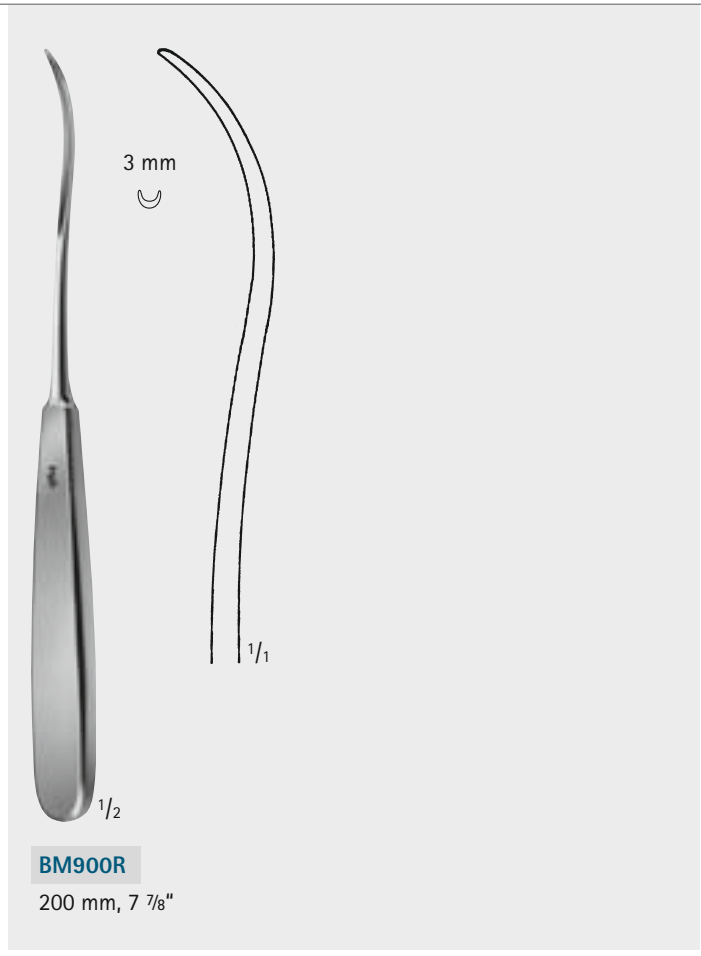

Needleholders
Nadelhalter

Needle Holders, Ligature Instruments – Nadelhalter, Ligatur-Instrumente

Guiding Probes

Führungshohlsonden

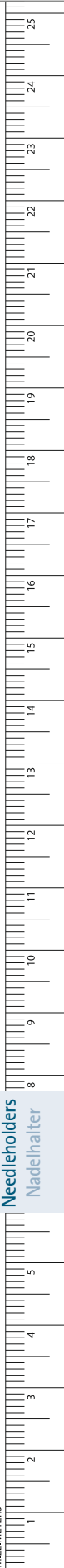
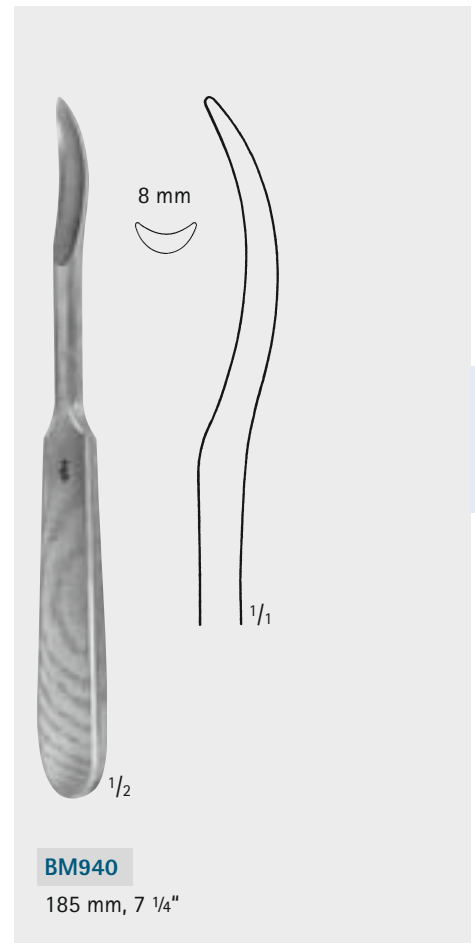
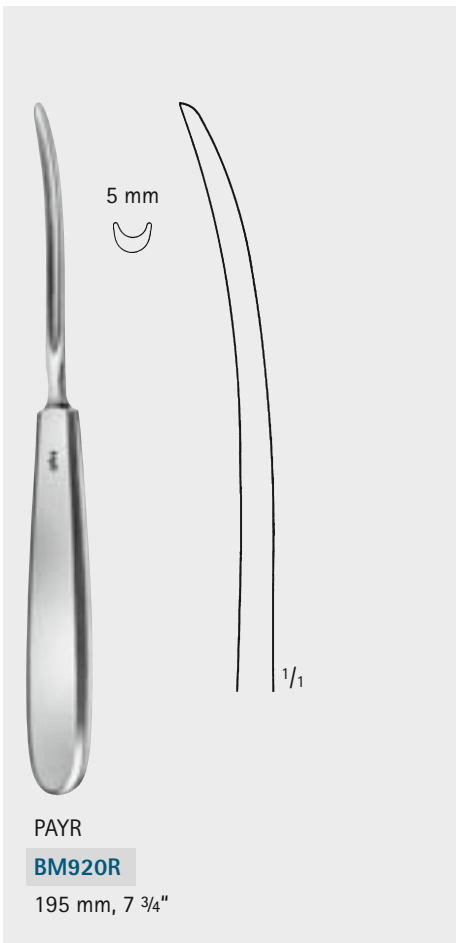
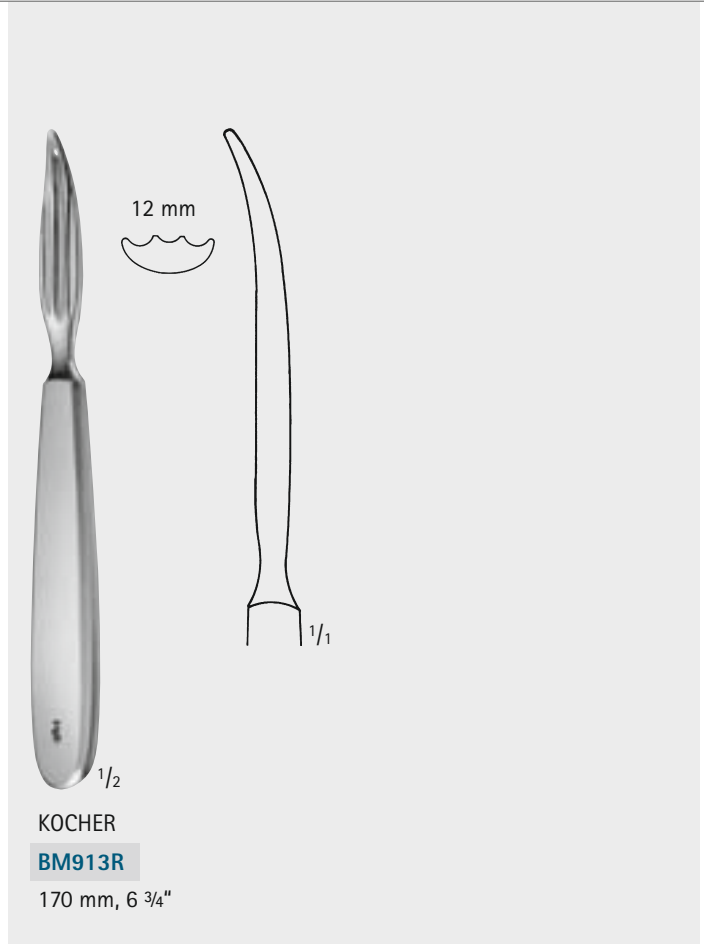
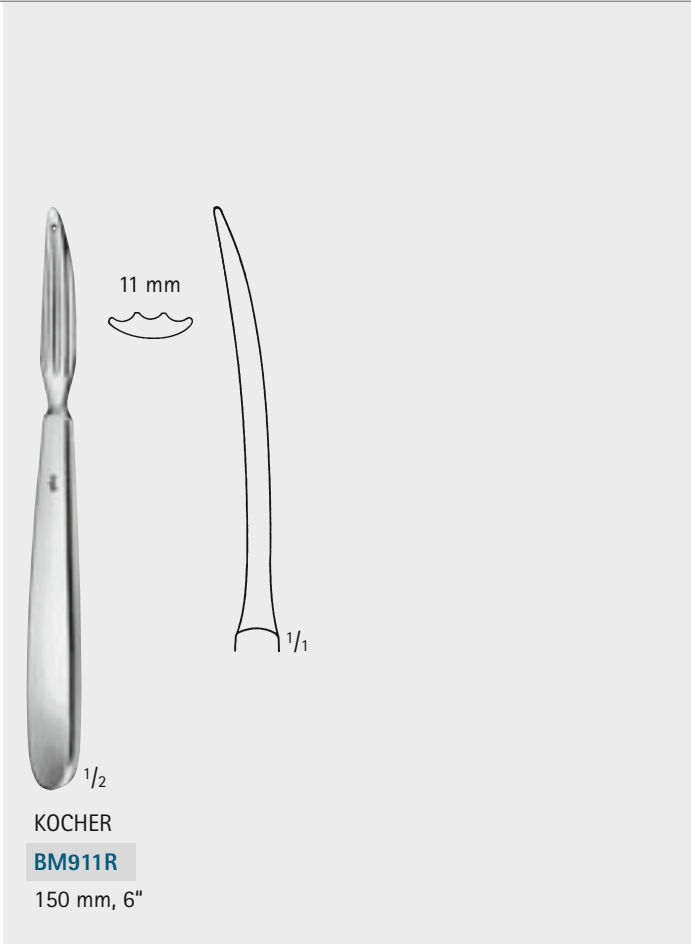

Needle Holders, Ligature Instruments – Nadelhalter, Ligatur-Instrumente

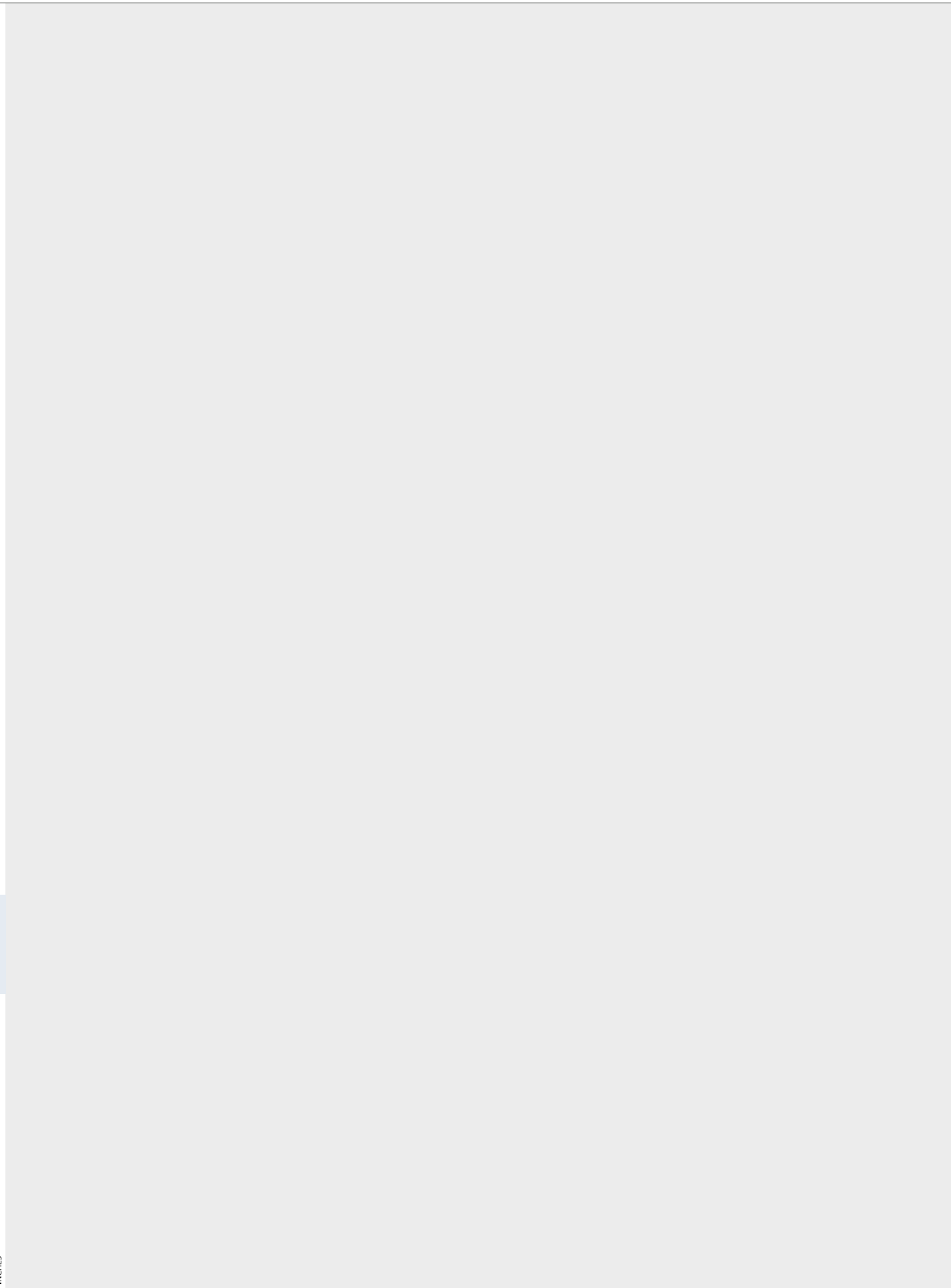

General Surgical Instruments Chirurgische Instrumente

- Probes
- Sonden

Probes, Cotton Carriers, Redon Spikes – Sonden, Watteträger, Redon Spieße

Directors

Hohlsonden



Probes
Sonden

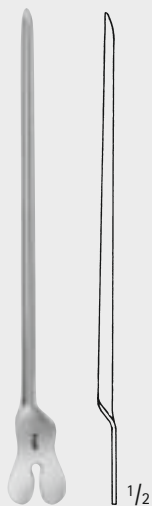

Art. No. Art. Nr.	Length Länge
BN003R	130 mm, 5 1/8"
BN004R	145 mm, 5 3/4"
BN006R	160 mm, 6 1/4"

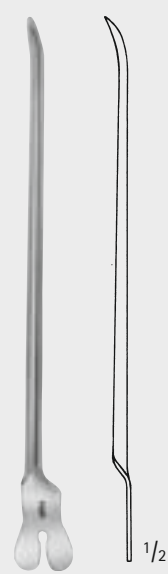

DOYEN
BN010R
145 mm, 5 3/4"

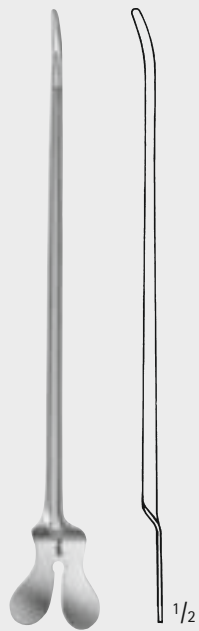

NELATON
BN012R
160 mm, 6 1/4"

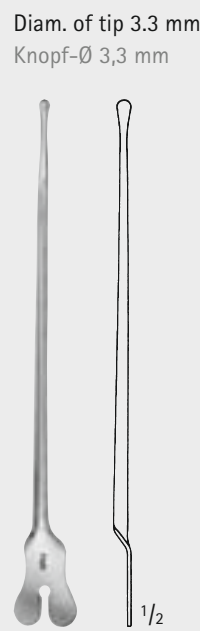

Diam. of tip 3.3 mm
Knopf-Ø 3,3 mm

BN015R
with tip
mit Knopf
140 mm, 5 1/2"

Diam. of tip 3.5 mm
Knopf-Ø 3,5 mm

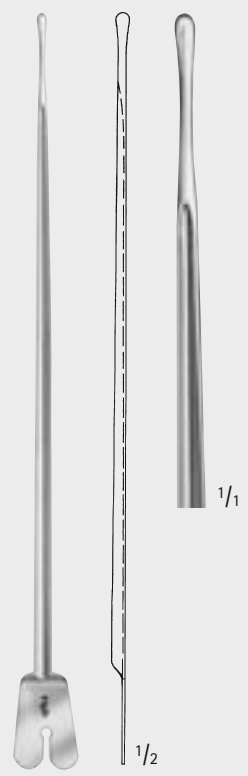

BRODIE
BN020R
with tip
mit Knopf
200 mm, 7 7/8"

Probes, Cotton Carriers, Redon Spikes – Sonden, Watteträger, Redon Spieße

Probes

Sonden



1/2

Art. No. Art. Nr.	Diam. of tip (mm) Knopf-Ø (mm)	Length Länge
BN034R	2.5	145 mm, 5 3/4"
BN036R	2.5	160 mm, 6 1/4"
BN040R	3.0	200 mm, 7 7/8"

Probes with eye
Öhrsonden



1/2

MB603R

125 mm, 5"

Diam. of tip 1.5 mm
Knopf-Ø 1,5 mm



1/2

BN054R

Myrtle leaf probe
Myrtenblattsonde
145 mm, 5 3/4"

Diam. of tip 2 mm
Knopf-Ø 2 mm



1/2

Art. No. Art. Nr.	Length Länge
BN063R	130 mm, 5 1/8"
BN064R	145 mm, 5 3/4"
BN066R	160 mm, 6 1/4"
BN068R	180 mm, 7"
BN070R	200 mm, 7 7/8"

Myrtle leaf probes
Myrtenblattsonden

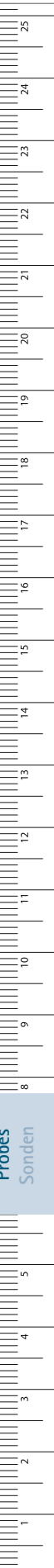

Probes
Sonden

MILLIMETERS

Probes, Cotton Carriers, Redon Spikes – Sonden, Watteträger, Redon Spieße

Probes

Sonden



Probes
Sonden



1/2

	Diam. of tip Kopf-Ø			Length Länge
	1 mm	1.5 mm	2.0 mm	
-		BN113R	-	130 mm, 5 1/8"
BN104R	BN114R	BN134R		145 mm, 5 3/4"
-	BN116R	BN136R		160 mm, 6 1/4"
-	BN118R	BN138R		180 mm, 7"
-	BN120R	BN140R		200 mm, 7 7/8"
-	BN125R	-		250 mm, 9 3/4"
-	-	BN150R		300 mm, 11 3/4"

Probes
Knopfsonden

Diam. of tip 1.2 mm
Knopf-Ø 1,2 mm



1/2

BN110
Sinus probe
Sinus-Knopfsonde
150 mm, 6"

Diam. of tip 3 mm
Knopf-Ø 3 mm



1/2

BN090R
Double ended probe,
malleable, with hole
Doppelknopfsonde,
biegsam, mit Loch
190 mm, 7 1/2"

Probes, Cotton Carriers, Redon Spikes – Sonden, Watteträger, Redon Spieße

Probes
Sonden

Diam. of tip 0.8 mm
Knopf-Ø 0,8 mm



STACKE

BN160

Ear probe
Ohrsonde
100 mm, 4"



CAWTHORNE

BN161

Ear probe, flattened end
Ohrsonde, flaches Ende
140 mm, 5 1/2"

Diam. of tip 1.5 mm
Knopf-Ø 1,5 mm



KILLIAN

BN172R

Nasal probe, slightly curved
Nasensonde, leicht gebogen
165 mm, 6 1/2"

Diam. of tip 1.4 mm
Knopf-Ø 1,4 mm



BN170R

Nasal probe, angled
Nasensonde, kniegebogen
160 mm, 6 1/4"

Diam. of tip 1 mm
Knopf-Ø 1 mm



SEIFFERT

OM488

Salivary Probe, Silver
Speichelgangsonde,
Silber
200 mm, 7 7/8"



BOWMAN

Art. No. Art. Nr.	Diam. Ø (mm)	Figure Figur	Length Länge
OB510	0.7 + 0.8	00/0	130 mm, 5 1/8"
OB511	0.9 + 1.1	1/2	130 mm, 5 1/8"
OB512	1.3 + 1.4	3/4	130 mm, 5 1/8"
OB513	1.5 + 1.6	5/6	130 mm, 5 1/8"
OB514	1.8 + 1.9	7/8	130 mm, 5 1/8"

Eye Probes, malleable
Stainless steel
Augensonden, biegsam
Edelstahl

WILDER

OM486R

Dilator for lacrymal duct
Tränenkanal-Dilatator
110 mm, 4 1/4"

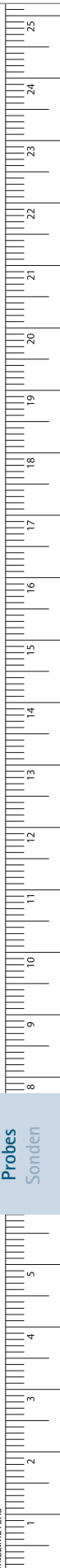

Probes
Sonden

MILLIMETERS

Probes, Cotton Carriers, Redon Spikes – Sonden, Watteträger, Redon Spieße

Tongue Spatulas, Cotton Carriers

Zungenspatel, Watteträger





BN184R
Tongue spatula
Zungenspatel
145 mm, 5 3/4"



16 mm
OM202R
Tongue spatula
Zungenspatel
145 mm, 5 3/4"

Diam. 0.7 mm
Ø 0,7 mm



1/1
1/2
MODELL PICCOLO
OF261R
Cotton carrier,
round serrated end
Watteträger,
rund gerieft
110 mm, 4 1/2"

Diam. 0.7 mm
Ø 0,7 mm



1/1
1/2
MODELL PICCOLO
OF262R
Cotton carrier,
triangular serrated end
Watteträger,
dreikant gerieft
110 mm, 4 1/2"

Diam. 1.2 mm
Ø 1,2 mm



1/1
1/2
FARRELL
OF257R
Cotton carrier,
round serrated end
Watteträger,
rund gerieft
110 mm, 4 1/2"

Diam. 1.4 mm
Ø 1,4 mm



1/1
1/2
LATHBURY-FARRELL
OF259R
Cotton carrier,
triangular serrated end
Watteträger,
dreikant gerieft
110 mm, 4 1/2"

Probes, Cotton Carriers, Redon Spikes – Sonden, Watteträger, Redon Spieße

Cotton Carriers

Watteträger

Diam. 0.9 mm
Ø 0,9 mm

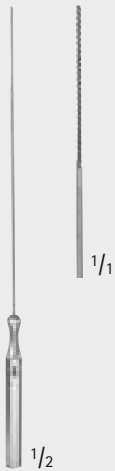

BUCK

BN400R

rough, spiral end
spiralförmig gerieft
120 mm, 4 3/4"

Diam. 0.9 mm
Ø 0,9 mm

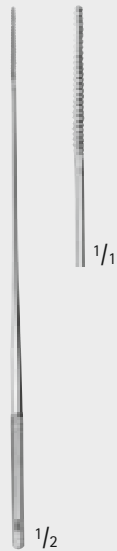

LATHBURY-FARRELL

BN467R

triangular serrated end
dreieckig gerieft
140 mm, 5 1/2"

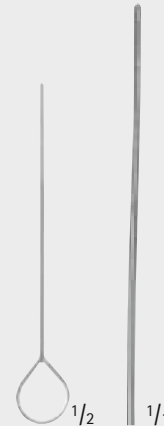

KINGS'S COLLEGE HOSPITAL

BN403

rough, spiral end
spiralförmig gerieft
90 mm, 3 1/2"



KINGS'S COLLEGE HOSPITAL

BN404

rough, spiral end
spiralförmig gerieft
135 mm, 5 1/4"

Diam. 1.0 mm
Ø 1,0 mm



BN440R

rough, spiral end
spiralförmig gerieft
140 mm, 5 1/2"

Diam. 1.2 mm
Ø 1,2 mm



BN445R

rough, spiral end
spiralförmig gerieft
140 mm, 5 1/2"

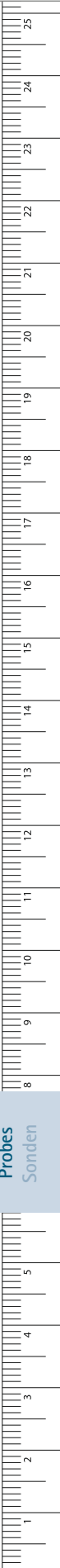

Probes, Cotton Carriers, Redon Spikes – Sonden, Watteträger, Redon Spieße

Cotton Carriers

Watteträger



Diam. 1.2 mm
Ø 1,2 mm

1/1

1/2

FARRELL
BN460R
round serrated end
rund gerieft
140 mm, 5 1/2"

Diam. 1.4 mm
Ø 1,4 mm

1/1

1/2

LATHBURY-FARRELL
BN465R
triangular serrated end
dreikant gerieft
140 mm, 5 1/2"

Diam. 1.2 mm
Ø 1,2 mm

1/1

1/2

FARRELL
BN461R
rough, spiral end
spiralförmig gerieft
160 mm, 6 1/4"

Diam. 1.2 mm
Ø 1,2 mm

1/1

1/2

LATHBURY-FARRELL
BN466R
triangular serrated end
dreikant gerieft
160 mm, 6 1/4"

Diam. 1.4 mm
Ø 1,4 mm

1/1

1/2

LATHBURY-FARRELL
BN468R
triangular serrated end
dreikant gerieft
160 mm, 6 1/4"

Diam. 1.5 mm
Ø 1,5 mm

1/1

1/2

FARRELL
BN452R
rough, spiral end
spiralförmig gerieft
180 mm, 7"

Diam. 1.8 mm
Ø 1,8 mm

1/1

1/2

FARRELL
BN457R
rough, spiral end
spiralförmig gerieft
180 mm, 7"

Probes
Sonden

Probes, Cotton Carriers, Redon Spikes – Sonden, Watteträger, Redon Spieße

Redon Spikes

Redon Spieße



Art. No. Art. Nr.	Charr. Charr.
BN902R	8
BN903R	10
BN904R	12
BN905R	14
BN906R	16
BN907R	18
with thread mit Gewindeanschluss 190 mm, 7 1/2"	



Art. No. Art. Nr.	Charr. Charr.
BN912R	8
BN913R	10
BN914R	12
BN915R	14
BN916R	16
BN917R	18
with thread mit Gewindeanschluss 190 mm, 7 1/2"	



Art. No. Art. Nr.	Charr. Charr.
BN922R	8
BN923R	10
BN924R	12
BN925R	14
BN926R	16
with thread mit Gewindeanschluss 190 mm, 7 1/2"	



Art. No. Art. Nr.	Charr. Charr.
BN942R	8
BN943R	10
BN944R	12
BN945R	14
BN946R	16
BN947R	18
with thread mit Gewindeanschluss 190 mm, 7 1/2"	

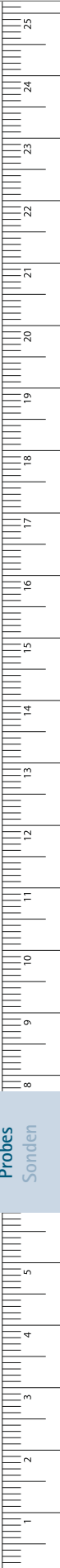

Probes, Cotton Carriers, Redon Spikes – Sonden, Watteträger, Redon Spieße

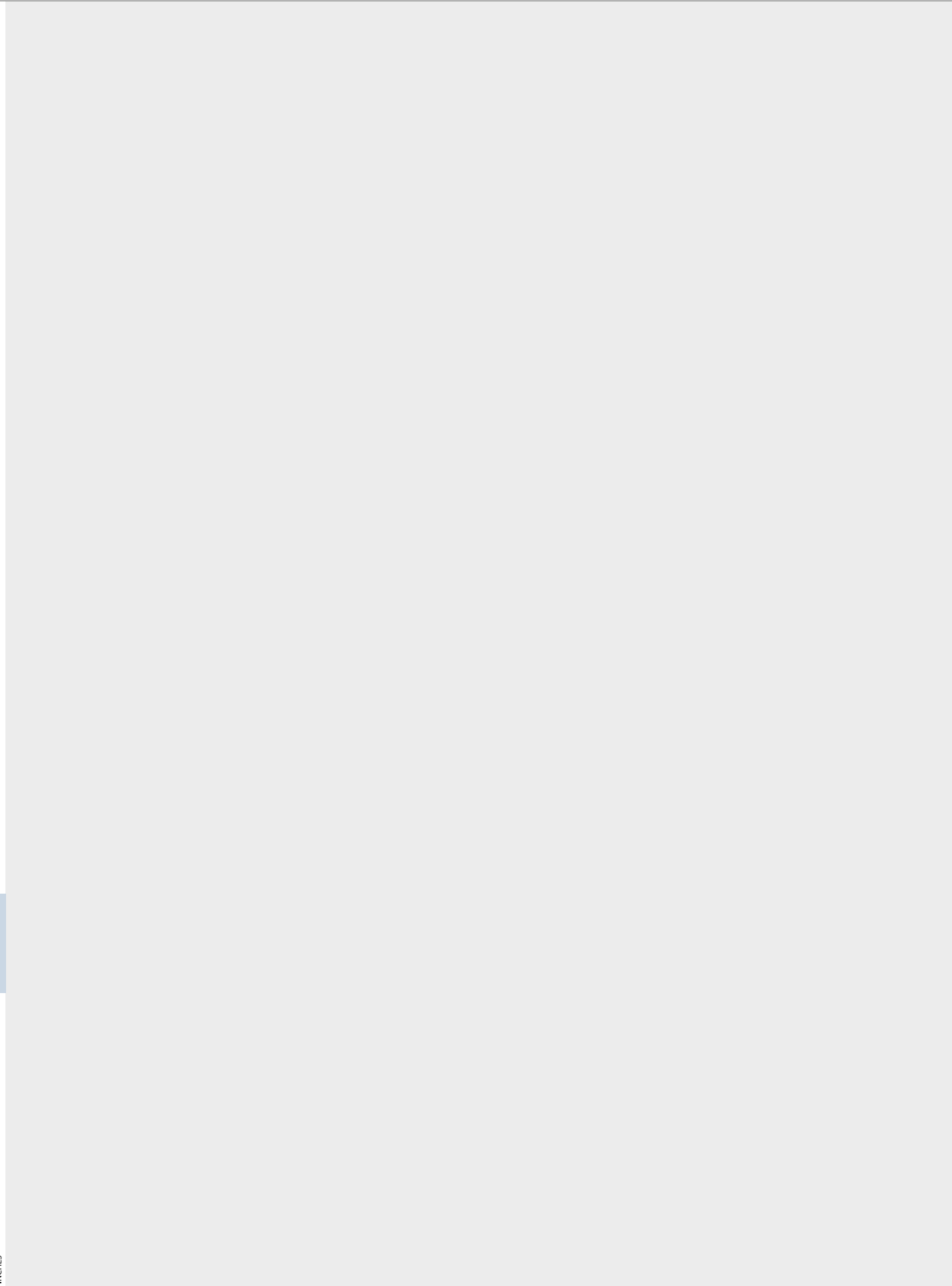

General Surgical Instruments Chirurgische Instrumente

- Suction Instruments
- Sauginstrumente

Suction Instruments, Syringes – Sauginstrumente, Spritzen

Suction Cannulas

Saugkanülen



Olive diam. 6 – 8 mm
Olive Ø 6 – 8 mm

PLESTER

OG970R

Suction set, complete, consisting of:

- OG971R Suction handle with finger cut-off, with LUER cone
- OG973R 2 Suction cannulas, diam. 0.7 mm, with LUER cone
- OG974R 2 Suction cannulas, diam. 1.0 mm, with LUER cone
- OG969R 2 Suction cannulas, diam. 1.3 mm, with LUER cone
- OG982R 2 Suction cannulas, diam. 1.5 mm, with LUER cone
- OG983R 2 Suction cannulas, diam. 2.0 mm, with LUER cone
- OG984R 2 Suction cannulas, diam. 2.5 mm, with LUER cone

Saugset komplett, bestehend aus:

- OG971R Saughandgriff mit Unterbrecher, mit LUER-Konus
- OG973R 2 Saugkanülen, Ø 0,7 mm, mit LUER-Konus
- OG974R 2 Saugkanülen, Ø 1,0 mm, mit LUER-Konus
- OG969R 2 Saugkanülen, Ø 1,3 mm, mit LUER-Konus
- OG982R 2 Saugkanülen, Ø 1,5 mm, mit LUER-Konus
- OG983R 2 Saugkanülen, Ø 2,0 mm, mit LUER-Konus
- OG984R 2 Saugkanülen, Ø 2,5 mm, mit LUER-Konus

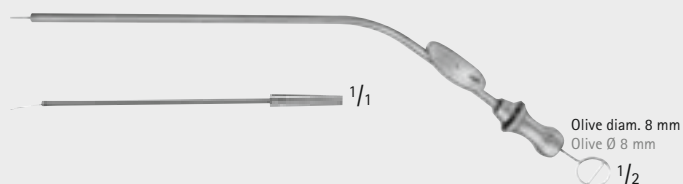

Olive diam. 8 mm
Olive Ø 8 mm

BELLUCCI

OG950R

Suction set, complete, consisting of:

- OG951R Suction tube with finger cut-off and stylet, 155 mm, 6"
- GF772R Detachable end, 20 swg. diam., 1.0 mm diam.
- GF773R Detachable end, 22 swg. diam., 0.7 mm diam.
- GF774R Detachable end, 24 swg. diam., 0.5 mm diam.

Saugset komplett, bestehend aus:

- OG951R Saugrohr, allein, mit Saugunterbrecher und Mandrin, 155 mm, 6"
- GF772R Saugkanüle, Ø 20 swg., Ø 1,0 mm
- GF773R Saugkanüle, Ø 22 swg., Ø 0,7 mm
- GF774R Saugkanüle, Ø 24 swg., Ø 0,5 mm

Suction Instruments, Syringes – Sauginstrumente, Spritzen

Suction Cannulas

Saugkanülen

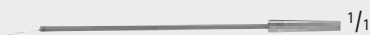

ZOELLNER

Art. No. Art. Nr.	Diam. (swg) Ø (swg)	Diam. (mm) Ø (mm)	Length Länge
GF771R	18	1.2	55 mm, 2 1/4"
GF772R	20	1.0	55 mm, 2 1/4"
GF773R	22	0.7	55 mm, 2 1/4"
GF774R	24	0.5	55 mm, 2 1/4"
GF775R	26	0.4	55 mm, 2 1/4"

detachable tips, fitting GF770R and OG951R

Sales unit:

PAK = Package of 10 pieces

auswechselbare Spitzen zu GF770R und OG951R

Bestelleinheit:

PAK = Packung à 10 Stück



VERHOEVEN

Art. No. Art. Nr.	Diam. (swg) Ø (swg)	Diam. (mm) Ø (mm)	Length Länge
GF763R	16	1.5	100 mm, 4"
GF764R	18	1.2	100 mm, 4"
GF765R	20	1.0	100 mm, 4"
GF766R	22	0.7	100 mm, 4"
GF767R	24	0.5	100 mm, 4"

Suction cannulas with LUER cone

Saugkanülen mit LUER-Konus



Suction
Sauger

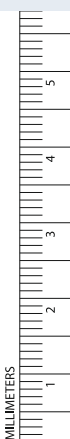

Suction Instruments, Syringes – Sauginstrumente, Spritzen

Suction Adapter, Suction Cannula

Saugadapter, Saugkanüle



Olive diam. 7 mm
Olive Ø 7 mm

HOUSE

GF768R

Suction adapter with finger cut-off,
LUER cone / LUER hub

Saugadapter mit Saugunterbrecher,
LUER-Konus / LUER-Bohrung
55 mm, 2 1/4"

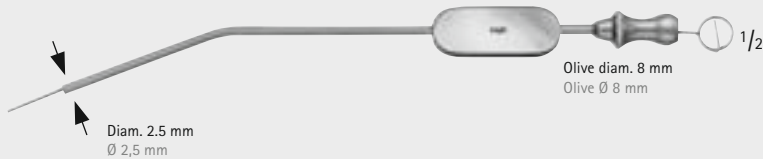

Diam. 2.5 mm
Ø 2,5 mm

Olive diam. 8 mm
Olive Ø 8 mm

ZOELLNER

GF770R

Suction cannula, only, with stylet
fitting to the detachable ends GF771R and GF775R

Saugkanüle allein, mit Mandrin,
passend zu den Saugkanülen GF771R und GF775R
180 mm, 7"

Suction Instruments, Syringes – Sauginstrumente, Spritzen

Suction Cannulas

Saugkanülen

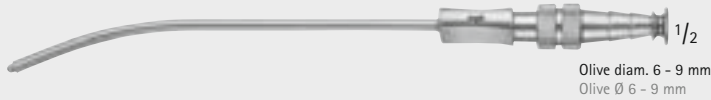

GILLIES

Art. No. Art. Nr.	Diam. (mm) Ø (mm)	Length Länge
----------------------	----------------------	-----------------

OL187R 3.0 170 mm, 6 3/4"

with finger cut-off and stylet
mit Saugunterbrecher und Mandrin

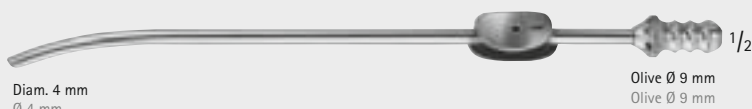

Diam. 4 mm
Ø 4 mm

ADSON

GF917R

with finger cut-off
mit Saugunterbrecher
190 mm, 7 1/2"



Diam. 3 mm
Ø 3 mm

ADSON

GF918R

with finger cut-off and stylet
mit Saugunterbrecher und Mandrin
165 mm, 6 1/2"

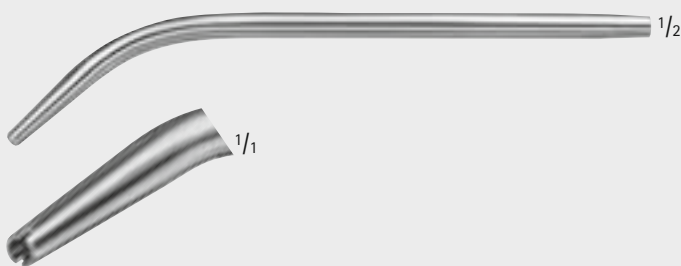

Art. No. Art. Nr.	Diam. (mm) Ø (mm)	Length Länge	Art. No. Art. Nr.	Diam. (mm) Ø (mm)	Length Länge
DF771R	2	140 mm, 5 1/2"	DF781R	2	170 mm, 6 3/4"
DF773R	3	140 mm, 5 1/2"	DF783R	3	170 mm, 6 3/4"
DF774R	4	140 mm, 5 1/2"	DF784R	4	170 mm, 6 3/4"
DF775R	5	140 mm, 5 1/2"	DF785R	5	170 mm, 6 3/4"

with notch at the working end to prevent premature suction
mit Einkerbung am Arbeitsende, zur Vermeidung des
vorschnellen Festsaugens

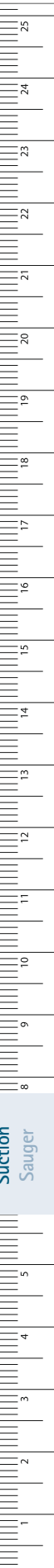

Suction
Sauger

MILLIMETERS

Suction Instruments, Syringes – Sauginstrumente, Spritzen

Suction Cannulas

Saugkanülen

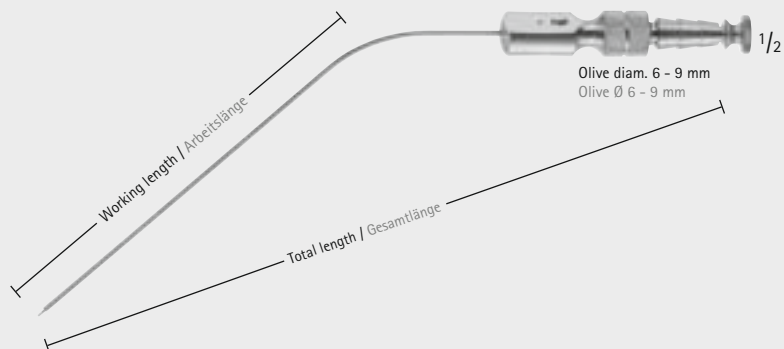

FERGUSSON

Working length Arbeitslänge	110 mm 4 1/2"	130 mm 5 1/8"	160 mm 6 1/4"	200 mm 7 7/8"
Total length Gesamtlänge	195 mm 7 3/4"	215 mm 8 1/2"	245 mm 9 5/8"	280 mm 11"
Diam. Ø				
1.5 mm	GF350R	GF360R	GF370R	GF380R
2.0 mm	GF351R	GF361R	GF371R	GF381R
2.5 mm	GF352R	GF362R	GF372R	GF382R
3.0 mm	GF353R	GF363R	GF373R	GF383R
4.0 mm	GF354R	GF364R	GF374R	GF384R
5.0 mm	GF355R	GF365R	GF375R	GF385R



PLESTER

Art. No. Art. Nr.	Diam. (mm) Ø (mm)	Length Länge
GF939R	1.5	195 mm, 7 3/4"
GF940R	2.0	195 mm, 7 3/4"
GF941R	2.5	195 mm, 7 3/4"
GF942R	3.0	195 mm, 7 3/4"

with finger cut-off and stylet, thumb piece parallel to curve,
with LUER hub
mit Saugunterbrecher und Mandrin, Griffplatte parallel zur Biegung,
LUER-Bohrung

Suction Instruments, Syringes – Sauginstrumente, Spritzen

Suction Cannulas

Saugkanülen

- Teardrop shaped thumb control for a very precise suction regulation
- Malleable material for individual forming of the suction hose
- Conical design of the tube prevents plugging
- Delivered with stylet

- Tropfenförmiger Saugunterbrecher für eine sehr feine Regulierung der Saugleistung
- Biegsames Material für individuelle Ausformung des Saugrohrs
- Konisches Design des Saugrohrs vermindert Verstopfung
- Saugkanüle wird mit Mandrin zur Reinigung geliefert

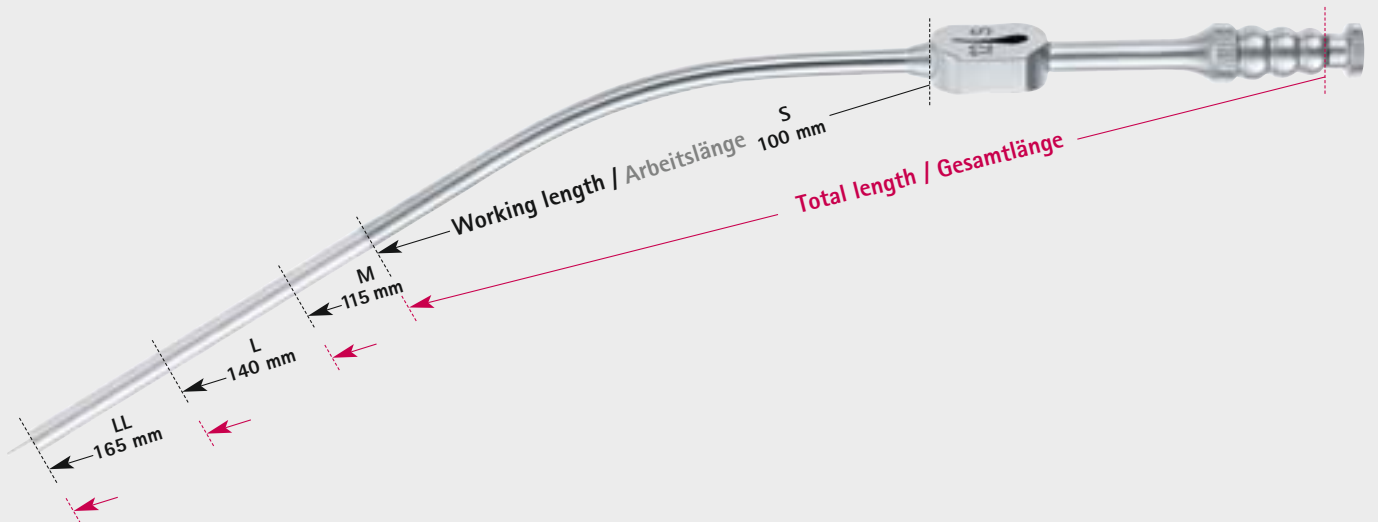

			S	M	L	LL
Working length Arbeitslänge			100 mm 4"	115 mm, 4 1/2"	140 mm 5 1/2"	165 mm 6 1/2"
Total length Gesamtlänge			165 mm 6 1/2"	180 mm 7"	205 mm 8"	230 mm 9"
Outer diam. Außen-Ø						
3 FR	◦	1.0 mm	GF401R	GF391R	GF411R	GF421R
4 FR	◦	1.4 mm	GF402R	GF392R	GF412R	GF422R
5 FR	◉	1.7 mm	GF403R	GF393R	GF413R	GF423R
6 FR	◉	2.0 mm	GF404R	GF394R	GF414R	GF424R
7 FR	◉	2.3 mm	GF405R	GF395R	GF415R	GF425R
8 FR	◉	2.7 mm	GF406R	GF396R	GF416R	GF427R
9 FR	◉	3.0 mm	GF407R	GF397R	GF417R	GF427R
10 FR	◉	3.3 mm	GF408R	GF398R	GF418R	GF428R
12 FR	◉	4.0 mm	GF409R	GF399R	GF419R	GF429R



Suction
Sauger



Suction Instruments, Syringes – Sauginstrumente, Spritzen

Suction Cannulas

Saugkanülen

RAABE micro suction

- Fine micro suction instruments
- Rigid instrument, ideal for precise preparations
- Atraumatic instrument tip
- Wider view of the operating site even for the narrowest of approaches
- Ring-coded length, available in:
 - 80 mm (1 ring)
 - 100 mm (2 rings)
 - 120 mm (3 rings)
 - 140 mm (4 rings)

Color-coded width, available in

- 4 FR (yellow)
- 6 FR (blue)
- 9 FR (green)

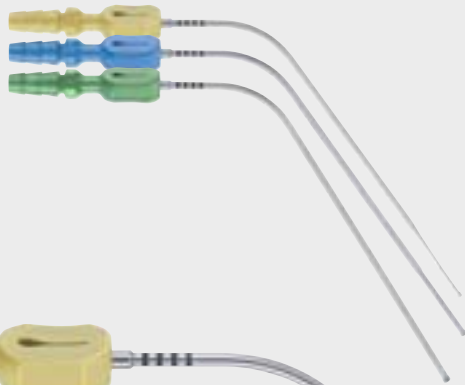
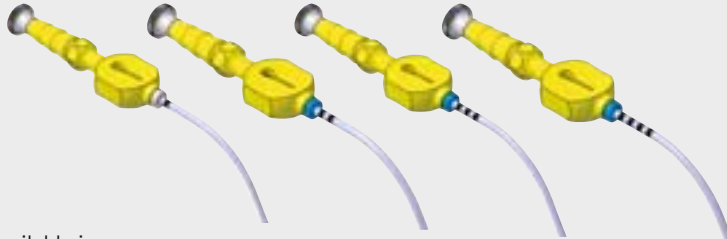

Mikro-Sauger nach RAABE

- Feine Mikro-Sauger
- Biegesteifes Instrument ideal für präzise Präparationen
- Atraumatische Instrumentenspitze
- Erweiterte Übersicht im OP-Gebiet auch bei kleinsten Zugängen
- Kodierte Längen über Strichcode, verfügbar in:
 - 80 mm (1 Ring)
 - 100 mm (2 Ringe)
 - 120 mm (3 Ringe)
 - 140 mm (4 Ringe)

Kodierte Breite, verfügbar in:

- 4 FR (gelb)
- 6 FR (blau)
- 9 FR (grün)

RAABE

Working length Arbeitslänge		80 mm 3 1/8"	100 mm 4"	120 mm 4 3/4"	140 mm 5 1/2"
Total length Gesamtlänge		130 mm 5 1/8"	150 mm, 6"	165 mm 6 1/2"	185 mm 7 1/4"
Color-coded width Kodierte Breite	Outside diam. Außen-Ø	1 ring 1 Ring	2 rings 2 Ringe	3 rings 3 Ringe	4 rings 4 Ringe
yellow/gelb	4 FR ◦ 1.4 mm	GF470R	GF473R	GF476R	GF479R
blue/blau	6 FR ⊙ 2.0 mm	GF471R	GF474R	GF477R	GF480R
green/grün	8 FR ⊚ 2.7 mm	GF472R	GF475R	GF478R	GF481R

Suction
Sauger

INCHES

Suction Instruments, Syringes – Sauginstrumente, Spritzen

Suction Cannulas

Saugkanülen

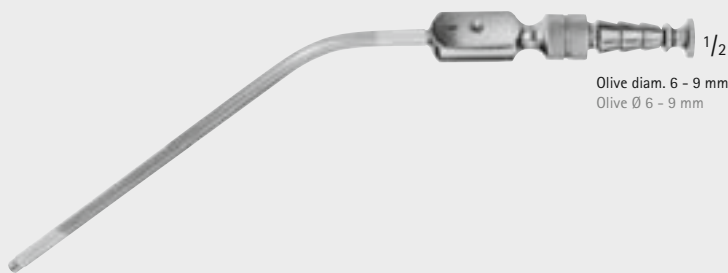

Olive diam. 6 - 9 mm
Olive Ø 6 - 9 mm

FERGUSSON

Art. No.	Diam. (mm)	Length
Art. Nr.	Ø (mm)	Länge
GF933R	4.0 mm	180 mm, 7"

insulated, with finger cut-off and stylet, thumb piece 90° to curve,
with LUER hub

isoliert, mit Saugunterbrecher und Mandrin, Griffplatte 90° zur Biegung,
LUER-Bohrung



Olive diam. 6 - 9 mm
Olive Ø 6 - 9 mm

FRAZIER

Art. No.	Diam. (mm)	Length
Art. Nr.	Ø (mm)	Länge
GF923R	3.0 mm	180 mm, 7"
GF925R	5.0 mm	180 mm, 7"

with finger cut-off and stylet, thumb piece 90° to curve,
with LUER hub

mit Saugunterbrecher und Mandrin, Griffplatte 90° zur Biegung,
LUER-Bohrung

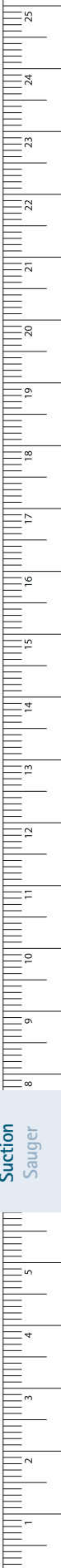

Suction
Sauger

MILLIMETERS

Suction Instruments, Syringes – Sauginstrumente, Spritzen

Suction Cannulas

Saugkanülen



FRAZIER

Art. No. Art. Nr.	Diam. (mm) Ø (mm)	Working length Arbeitslänge
MD124R	2.3	110 mm, 4 1/4"
MD125R	2.7	110 mm, 4 1/4"
MD127R	3.4	110 mm, 4 1/4"
MD129R	4.0	110 mm, 4 1/4"
MD130R	5.0	110 mm, 4 1/4"

Suction cannula with finger cut-off and stylet, thumb piece 90° to curve, with LUER hub
 Saugkanüle mit Saugunterbrecher und Mandrin, Griffplatte 90° zur Biegung, LUER-Bohrung

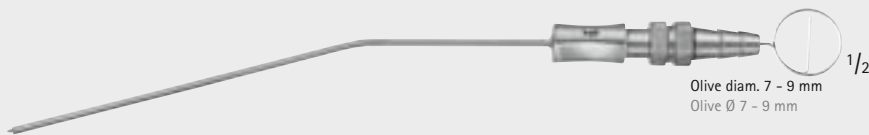

LEMPERT

Art. No. Art. Nr.	Diam. (mm) Ø (mm)	Length Länge
GF937R	2.0	200 mm, 7 7/8"
GF938R	3.0	200 mm, 7 7/8"

with finger cut-off and stylet
 mit Saugunterbrecher und Mandrin



FORMBY

Art. No. Art. Nr.	Diam. (mm) Ø (mm)	Length Länge
GF932R	3.3	210 mm, 8 1/4"

Suction
Sauger

INCHES

Suction Instruments, Syringes – Sauginstrumente, Spritzen

Suction Cannulas

Saugkanülen



BARRON

Art. No.	Diam. (mm)	Length
Art. Nr.	Ø (mm)	Länge

GF935R	1.3	160 mm, 6 1/4"
---------------	-----	----------------

GF936R	2.0	160 mm, 6 1/4"
---------------	-----	----------------

with finger cut-off and stylet

mit Saugunterbrecher und Mandrin



SCHUHKNECHT

Art. No.	Diam. (swg)	Diam. (mm)	Length
Art. Nr.	Ø (swg)	Ø (mm)	Länge

GF756R	20	1.0	130 mm, 5 1/8"
---------------	----	-----	----------------

GF757R	24	0.5	130 mm, 5 1/8"
---------------	----	-----	----------------

Suction cannulas

Saugkanülen



Art. No.	Diam. (mm)	Tip size (mm)	Length
Art. Nr.	Ø (mm)	Spitzenbreite (mm)	Länge

GF919R	5.0	6.5	180 mm, 7"
---------------	-----	-----	------------

Nasal suction tube, with LUER hub

Nasensaugrohr, LUER-Bohrung

Suction
Sauger

MILLIMETERS

Suction Instruments, Syringes – Sauginstrumente, Spritzen

Suction Cannulas

Saugkanülen

MAGILL

Art. No. Art. Nr.	Diam. (mm) Ø (mm)	Length Länge
GF906R	3.0	245 mm, 9 5/8"
GF907R	3.5	245 mm, 9 5/8"
GF908R	4.0	245 mm, 9 5/8"

GF909R
 Stylet for MAGILL suction tubes
 Reinigungsdraht zu MAGILL-Saugkanülen



ROWBOTHAM

OM672R
 with stylet
 mit Mandrin
 295 mm, 11 5/8"

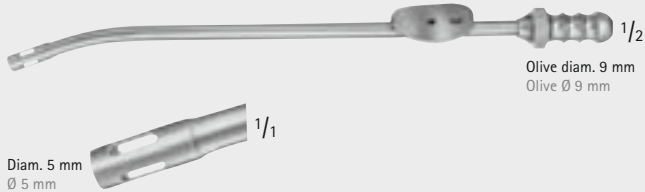

DE BAKEY

GF947R
 with finger cut-off and stylet
 mit Saugunterbrecher und Mandrin
 160 mm, 6 1/4"

Olive diam. 9 mm
 Olive Ø 9 mm

Diam. 5 mm
 Ø 5 mm

Suction Instruments, Syringes - Sauginstrumente, Spritzen

Suction Cannulas

Saugkanülen

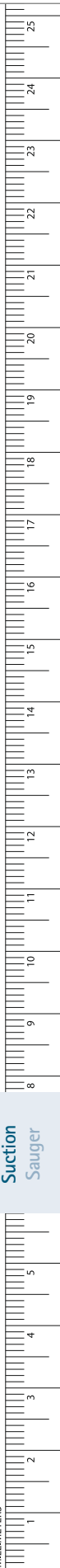
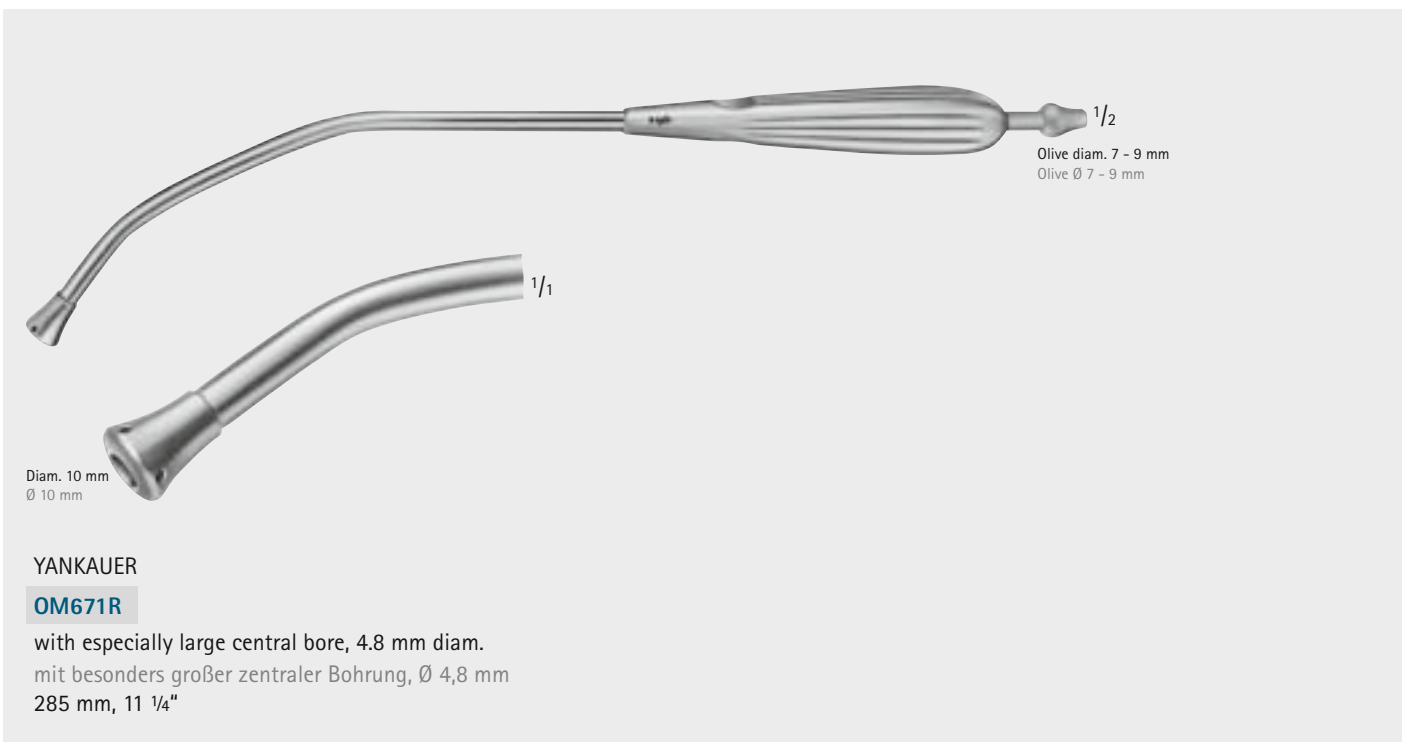
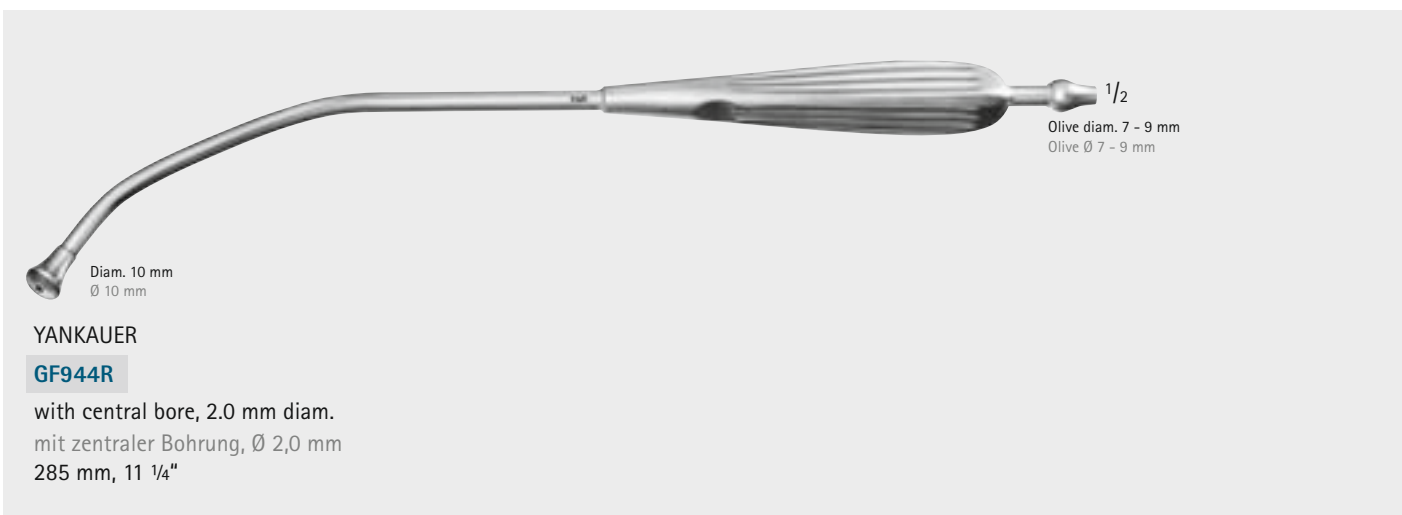

Suction
Sauger

Suction Instruments, Syringes – Sauginstrumente, Spritzen

Suction Cannulas

Saugkanülen



Diam. 3.5 mm
Ø 3,5 mm

Diam. 2.0 mm
Ø 2,0 mm

Olive
diam. 6 - 9 mm
Olive
Ø 6 - 9 mm

Art. No. Art. Nr.	Working length Arbeitslänge
----------------------	--------------------------------

OP030R	500 mm, 19 3/4"
---------------	-----------------

OP031R	350 mm, 13 3/4"
---------------	-----------------

with rubber tip, with LUER hub
mit Gummispitze, mit LUER-Bohrung

250 mm, 9 3/4"

Art. No. Art. Nr.	Diam. (mm) Ø (mm)	Working length Arbeitslänge
----------------------	----------------------	--------------------------------

OP360R	2.0	250 mm, 9 3/4"
---------------	-----	----------------

OP361R	2.5	250 mm, 9 3/4"
---------------	-----	----------------

OP362R	3.0	250 mm, 9 3/4"
---------------	-----	----------------

Olive
diam. 6 - 9 mm
Olive
Ø 6 - 9 mm



Olive diam. 6 mm
Olive Ø 6 mm

NEGUS

OL177R

Suction dissector

Saugdissektor

210 mm, 8 1/4"



Olive diam. 6 - 10 mm
Olive Ø 6 - 10 mm

GORNEY

OL168R

Suction dissector

Saugdissektor

180 mm, 7"

Suction Instruments, Syringes – Sauginstrumente, Spritzen

Suction Raspatories, Dissecting Suction Tube, Tonsil Dissector

Saugraspatorien, Präpariersauger, Tonsillendissektor



Art. No.	Diam. (mm)	Length
Art. Nr.	Ø (mm)	Länge

OL195R 4 200 mm, 7 7/8"

OL196R 5 200 mm, 7 7/8"

Suction raspatories, sharp, bayonet-shaped, with stylet

Saugraspatorium, scharf, bajonettförmig gebogen, mit Mandarin



LANDOLT

Art. No.	Diam. (mm)	Length
Art. Nr.	Ø (mm)	Länge

GF980R 3.2 200 mm, 7 7/8"

Dissecting suction tube for hypophysectomy and ENT,
sharp angled point

Präpariersauger für Hypophysektomie und HNO,
winklige Spitze, scharf



LOPEZ-REINKE

OM670R

Tonsil dissector with suction device

Tonsillendissektor mit Absaugvorrichtung
235 mm, 9 1/4"

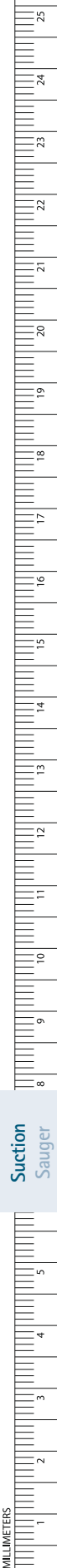

Suction
Sauger

MILLIMETERS

Suction Instruments, Syringes – Sauginstrumente, Spritzen

Suction Cannulas

Saugkanülen

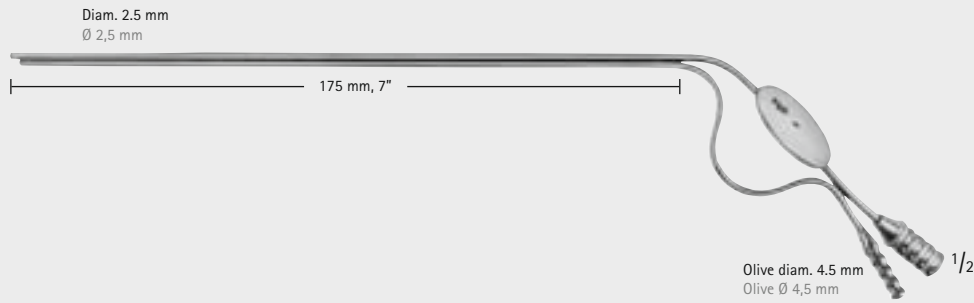

GF910R

with finger cut-off and stylet
mit Saugunterbrecher und Mandrin
175 mm, 6 7/8"



HOUSE

Art. No. Art. Nr.	Diam. (mm) suction tube Ø (mm) Saugrohr	Diam. (mm) irrigation tube Ø (mm) Spülrohr
GF911R	0.9	0.7
GF912R	1.2	0.9
GF913R	1.5	1.2

with finger cut-off and stylet, with LUER hub
mit Saugunterbrecher und Mandrin, LUER-Bohrung

Suction Instruments, Syringes – Sauginstrumente, Spritzen

Syringes, Tonsil and Septum Needles, Injection Needles

Spritzen, Tonsillen- und Septumnadeln, Injektionsnadel

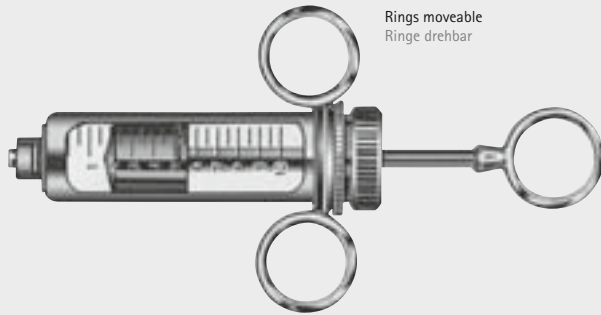

Art. No. Art. Nr.	Content Inhalt
SP330	2 ml
SP333	5 ml
SP336	10 ml

Syringe, complete
Spritze, komplett

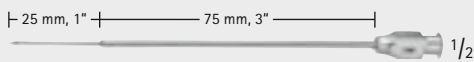

SF811R

Tonsil needle, straight
with LUER-LOCK attachment
Tonsillenkanüle, gerade
mit LUER-LOCK-Ansatz

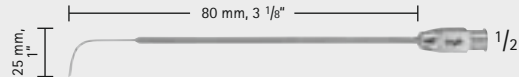

SF813R

Tonsil needle, strongly curved
with LUER-LOCK attachment
Tonsillenkanüle, stark gebogen
mit LUER-LOCK-Ansatz

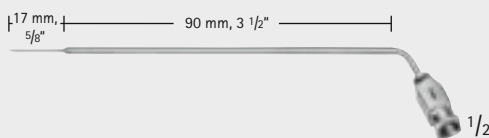

SF812R

Septum needle, angled
with LUER-LOCK attachment
Septumkanüle, abgewinkelt
mit LUER-LOCK-Ansatz

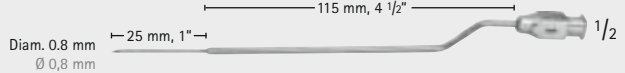

SF814R

Septum needle, bayonet-shaped
with LUER-LOCK attachment
Septumkanüle, bajonettförmig gebogen
mit LUER-LOCK-Ansatz

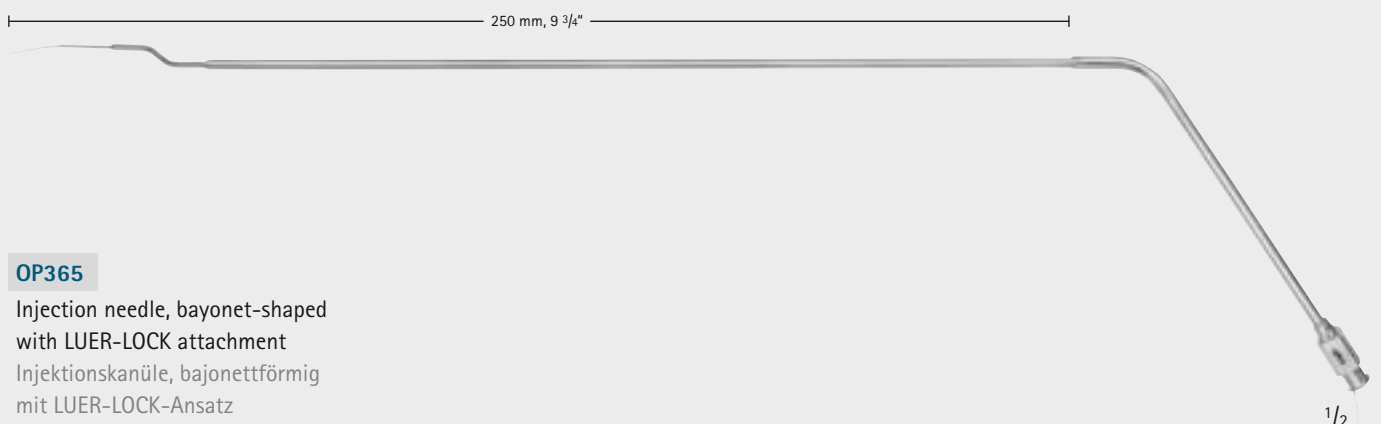

OP365

Injection needle, bayonet-shaped
with LUER-LOCK attachment
Injektionskanüle, bajonettförmig
mit LUER-LOCK-Ansatz

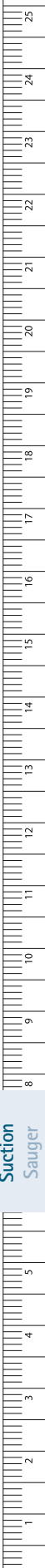

Suction
Sauger

MILLIMETERS

Suction Instruments, Syringes – Sauginstrumente, Spritzen

Syringes, Needle Attachment

Spritzen, Kanülenkopf

- Aesculap Cartridge Syringe "Aspira-plus II" made of stainless instrument-steel, with aspiration device. After having inserted the ampulla and the cannula the syringe is immediately ready for injection. By a slight twist of the piston rod to the right the double corkscrew tip will grasp the foam rubber of the ampulla. This enables a safe and controlled aspiration.



Advantages:

- Easy and safer processing by using corrosion- and acid resistant instrument steel instead of chrome material
- Easy cartridge insert and ejection by folding back the bush
- Enables controlled and safe aspiration



- Aesculap Zylinderampullenspritze "Aspira-plus II" aus rostfreiem Instrumentenstahl, mit Aspirationsvorrichtung. Nach Einschieben der Ampulle und Aufsetzen der Kanüle ist die Spritze injektionsbereit. Durch leichtes Rechtsdrehen der Kolbenstange erfasst die Doppelkorkenzieherspitze den Moosgummikolben der Ampulle. Dadurch wird eine sichere und zuverlässige Aspiration ermöglicht.

Vorteile:

- Einfache und sichere Aufbereitung durch Verwendung von rost- und säurebeständigem Instrumentenstahl anstelle von verchromten Material
- Umklappbare Hülse für leichtes Einführen und Auswerfen der Ampulle
- Kontrolliertes und sicheres Aspirieren



Art. No.	Content
Art. Nr.	Inhalt
SL018R	1.8 ml
SL022R	2.2 ml

Syringe with long needle (SL002R)
Spritze mit langem Kanülenkopf (SL002R)



Art. No.	Content
Art. Nr.	Inhalt
SL118R	1.8 ml
SL122R	2.2 ml

Syringe with crutch handle, with long needle attachment (SL002R)
Spritze mit Krückengriff, mit langem Kanülenkopf (SL002R)



SL002R

Needle attachment, long, suitable for all disposable needles with a thread diameter of 6 mm and long cartridge pick (e.g. Sterican®Z, B. Braun etc.)
Kanülenkopf, lang, geeignet für alle Einmalkanülen mit einem Gewinde-Ø von 6 mm und langer Ampullen-Einstichkanüle (z. B. Sterican®Z, B. Braun etc.)

Suction Sauger

INCHES

Suction Instruments, Syringes – Sauginstrumente, Spritzen

Syringes, Needle Attachment

Spritzen, Kanülenkopf



1/2

Art. No.	Content
Art. Nr.	Inhalt

SL028R	1.8 ml
---------------	--------

SL032R	2.2 ml
---------------	--------

Syringe with short needle attachment (SL033R)

Spritze mit kurzem Kanülenkopf (SL033R)



1/1

1/1

SL033R

Short needle attachment only, for American disposable needles with small thread (5.5 mm diam.) and short cartridge pick

Kurzer Kanülenkopf allein, für amerikanische Einmalkanülen mit kleinem Gewinde (Ø 5,5 mm) und kurzer Ampullen-Einstichkanüle

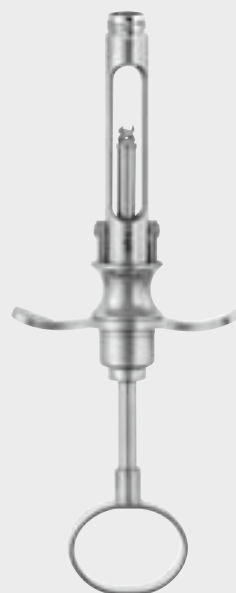

Art. No.	Content
Art. Nr.	Inhalt

SL017R	1.8 ml
---------------	--------

Syringe without needle attachment

Spritze ohne Kanülenkopf



1/1

1/1

SL034R

Short needle attachment only, for disposable needles, with large thread (6 mm diam.) and short cartridge pick

Kurzer Kanülenkopf allein, für Einmalkanülen, mit großem Gewinde (Ø 6 mm) und kurzer Ampullen-Einstichkanüle

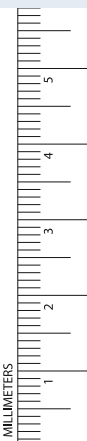
Suction
Sauger

MILLIMETERS



Please find further information about SUSI Single Use Surgical Instruments in our brochure C82002.

Weitere Information über SUSI Einmalinstrumente, siehe Prospekt C82001.



Please find further information about Electrosurgical Instruments in our brochure C30481.

Weitere Information über Elektrochirurgie Instrumente, siehe Prospekt C30481.



Please find further information about Power Systems in our brochure O22702.

Weitere Information über Motorensysteme, siehe Prospekt O22701.



Reprocessing
Aufbereitung



Aesculap Sterile Technology.

A worldwide leading manufacturer since decades

For more than 40 years, Aesculap is a leading manufacturer of sterile containers representing the sterile supplies packaging and the systematic organisation of the sterile supply cycle.

In 1971, when Aesculap invented and presented the first genuine sterile container – based on research and development in which Aesculap had played a crucial role since the beginning of the 20th century – this marked the arrival of a world first. The revolutionary packing and supply system quickly proved itself and soon was established in Germany, Europe and the USA. During all this change, the patient has always been the paramount consideration: from preservation of the sterility of surgical instruments through transport and storage periods right to the operating table. Through their innovative technology, Aesculap sterile containers became an established part of the sterile supply cycle. By using Aesculap sterile containers, the entire cycle of supply and disposal of sterile materials can be standardised, controlled and documented: from sterile storage and transport, through easy setup in the operating room, to protected disposal of the used instruments. At the disposal stage, Aesculap sterile containers reliably protect hospital staff against contamination and thereby support hospital quality management systems with regard to hygiene and infection prophylaxis.



Weltweit führender Anbieter seit Jahrzehnten

Seit mehr als 40 Jahren ist Aesculap führender Hersteller von Sterilcontainern für die Sterilgutverpackung zur systematischen Organisation des Sterilgutkreislaufes.

Mit der Erfindung und Bereitstellung des ersten echten Sterilcontainers schuf Aesculap 1971 ein weltweites Novum – basierend auf einer Forschungs- und Entwicklungsarbeit, die Aesculap bereits seit Anfang des 20. Jahrhunderts entscheidend mitgeprägt hat. Das damals revolutionäre Verpackungs- und Bereitstellungssystem bewährte sich schnell und setzte sich bald in Deutschland, Europa und den USA durch. Im Vordergrund der Bewertung stand dabei stets der Patient: Von der Sterilerhaltung der chirurgischen Instrumente während Transport und

Lagerdauer bis hin zum operativen Einsatz.

Ihre innovative Technologie sowie die komfortable Handhabung haben Aesculap Sterilcontainer zu einem festen Bestandteil der Sterilgutversorgung werden lassen. Durch die Verwendung der Sterilcontainer ist der gesamte Kreislauf der Sterilgutver- und entsorgung standardisierbar, kontrollierbar und dokumentierbar: dies gilt für die sterile Lagerung und den sterilen Transport ebenso wie für die einfache Bereitstellung im OP und die sichere Entsorgung der benutzten Instrumente. Bei der Entsorgung schützen Aesculap Sterilcontainer das Klinikpersonal zuverlässig vor Kontamination und unterstützen somit das Qualitätsmanagement der Klinik hinsichtlich Hygiene und Infektionsprophylaxe.

Reprocessing, Care & Maintenance – Aufbereitung, Pflege und Reinigung



Four good reasons to choose the Sterile Container System:

- Protection for patients and staff through preservation of instrument sterility and closed transport of used instruments
- Advantages due to reusable packaging, low costs of use and long service life
- Comfortable handling: simple, quick and reliable
- Transparency: standardised easy documentation of the supply cycle

Vier gute Gründe für das Sterilcontainer System:

- Schutz für Patient und Personal durch Sterilerhaltung der Instrumente und geschlossenen Transport benutzter Instrumente
- Vorteile durch die Wiederverwendbarkeit der Verpackung, niedrige Gebrauchskosten und eine hohe Lebensdauer
- Komfortable Handhabung: einfach, schnell und verlässlich
- Übersichtlichkeit: standardisierbar, einfache Dokumentation des Warenkreislaufes

Dedicated solutions for individual requirements

As a leading supplier of comprehensive sterile supply management systems worldwide, Aesculap can offer an extensive, clinically proven product portfolio for sterile packaging. The diversity of the Aesculap Sterile Container System offers packaging solutions for every instrument tray used in hospital practice. Containers in various variants and sizes and the comprehensive range of accessories make the Aesculap Sterile Container System a universal solution for the sterile supply of surgical instruments.

Training, development

Aesculap is involved in the continuous improvement of sterile supply everywhere in the world, through training events held by the Aesculap Academy, contributions by Aesculap staff and collaborators at national and international conferences, and extensive consulting activities on site with the user. At the same time, the Aesculap Sterile Container System benefits from continuous development to meet new demands on the processing and sterilization of surgical instruments, be it by using new materials or by introducing intelligent germ barrier systems.

Spezielle Lösungen für individuelle Ansprüche

Als ein weltweit führender Anbieter für das gesamte Sterilgutmanagement verfügt Aesculap über eine umfangreiche und praxisbewährte Produktpalette zur Sterilgutverpackung. Die Vielfalt des Aesculap Sterilcontainer Systems bietet Verpackungslösungen für alle in der Praxis verwendeten Instrumentensiebe des Krankenhauses. Container in verschiedenen Versionen und Größen sowie das umfangreiche Zubehör machen das Sterilcontainer System zu einer Universallösung für die Sterilgutversorgung mit chirurgischen Instrumenten.

Weiterbildung, Weiterentwicklung

Aesculap engagiert sich weltweit für die kontinuierliche Verbesserung der Sterilgutversorgung durch Weiterbildungsveranstaltungen der Aesculap Akademie, durch Referententätigkeit von Aesculap Mitarbeitern bei nationalen und internationalen Kongressen sowie durch umfangreiche Beratungstätigkeiten beim Anwender selbst. Parallel wird das Aesculap Sterilcontainersystem beständig weiterentwickelt, um neuen Anforderungen der Aufbereitung und Sterilisation chirurgischer Instrumente gerecht zu werden, sei es durch die Verwendung neuer Materialien oder den Einsatz intelligenter Keimrückhaltesysteme.

Think Competence. Think Aesculap.



Knowledge exchange – our conviction

As a competent partner for the sterile materials supply in hospitals, Aesculap supports the specialist training and qualification of staff in central sterile supplies departments and operating rooms. This is achieved for instance by offering training events held by the Aesculap Academy all over the world and by sending specialist speakers to national and international conferences.

Active participation in national and international standards committees, professional associations and working groups provides a solid basis for the development of high-quality and reliable products, always in dialogue with the user community. This lively knowledge exchange between all parties is the hallmark of our philosophy: sharing expertise.

Wissensaustausch aus Überzeugung

Als kompetenter Partner für die Sterilgutversorgung im Krankenhaus unterstützt Aesculap die Fachausbildung und Qualifizierung der Mitarbeiter in Zentralsterilisation und OP. Dies erfolgt unter anderem durch die weltweiten Schulungsangebote der Aesculap Akademie und eigene Fachreferenten bei nationalen und internationalen Kongressen. Die aktive Beteiligung an

nationalen und internationalen Normenausschüssen, Fachgesellschaften und Arbeitskreisen schafft eine solide Basis für die Entwicklung hochwertiger und sicherer Produkte im Dialog mit den Anwendern. Dieser rege Wissensaustausch zwischen allen Beteiligten steht ganz im Zeichen der Philosophie von Sharing Expertise.

Competence in demand planning and tray optimization

At the project planning stage, the Aesculap planning team cooperates with surgical staff and sterile supplies specialists to adapt the configuration of required sterile containers, trays and organization aids to the existing instrument trays.

Kompetenz in Bedarfsplanung und Sieboptimierung

Im Rahmen der Projektplanung durch das Aesculap Planungsteam wird in Zusammenarbeit mit dem Fachpersonal aus Operationsabteilung und Sterilgutversorgung die Zusammenstellung der benötigten Sterilcontainer, Siebkörbe und Organisationshilfen an bereits vorhandene Instrumentensiebe angepasst.

Think Economy. Think Aesculap.

Significant advantages over the entire system lifespan

All hospitals are obliged and challenged to apply process optimization to make hospital processes more efficient and cost-effective. At the same time, there remains the basic duty to consider quality standards to maintain legal security and patient safety.

With the Sterile Container System, Aesculap can provide a crucial contribution towards these objectives. In contrast to single-use packaging, sterile

containers are capital assets offering a long service life. We are convinced that in comparison to single-use packaging, despite of its higher acquisition costs, the Aesculap sterile container system offers the following advantages in the course of its long service life:

- No recurring costs for packaging materials
- Reduction or elimination of disposal costs for single-use materials
- Time savings during packaging process
- Time savings at the sterilization stage
- Reduced incidence of re-sterilization due to robust sterile packaging system
- Fast and easy aseptic presentation
- Easy transportation from and to the OR
- Long service life

Wesentliche Vorteile – ein Leben lang

Prozessoptimierung mit dem Ziel, Abläufe im Krankenhaus effizienter und kostengünstiger zu gestalten, sind Aufgabe und Herausforderung für jede Klinik. Grundlegende Verpflichtung ist dabei die gleichzeitige Berücksichtigung von Qualitätsstandards unter den Aspekten der Rechts- und Patientensicherheit. Hierzu leistet Aesculap mit dem Sterilcontainer System einen wesentlichen Beitrag.

Im Gegensatz zu den Einmalverpackungen sind Sterilcontainer langlebige Wirtschaftsgüter. Wir sind überzeugt, dass im Vergleich zur Einmalverpackung das Aesculap Sterilcontainer System während seines langjährigen Einsatzes trotz seiner höheren Anschaffungskosten folgende Vorteile aufweist:

- Keine wiederkehrenden Kosten für Verpackungsmaterial
- Geringere/keine Entsorgungskosten für Einmalmaterial
- Geringerer Zeitaufwand beim Packen der Siebe
- Aufgrund der stabilen Verpackung des Sterilguts geringere Re-Sterilisationsraten wegen beschädigter Verpackungen
- Schnelle Sterilbereitstellung
- Einfacher Transport im Sterilkreislauf
- Hohe Lebensdauer der Sterilcontainer

We will gladly provide a comparative calculation based on the specific conditions in your organization.

Gerne stellen wir Ihnen eine Vergleichsrechnung basierend auf Ihre individuellen Verhältnisse zur Verfügung.



Think Quality. Think Aesculap.

Quality without compromise

More than 40 years of experience in sterile supplies provision have resulted in practical and user-friendly solutions. However, maintaining the sterility of surgical instruments has always been of paramount importance.

All components of the Aesculap Sterile Container System meet the requirements of national and international standards for sterile packaging, in particular:

- DIN EN ISO 11607
- DIN 58953, Part 9
- MDD 93/42/EWG

The robust design and state-of-the-art manufacturing methods of Aesculap ensure a reliability and consistency of the shape, dimensions and integrity of the sterile containers, instrument trays and other system components. This, and the use of high-grade materials in all components, ensures a long and virtually maintenance-free service life of our sterile containers.

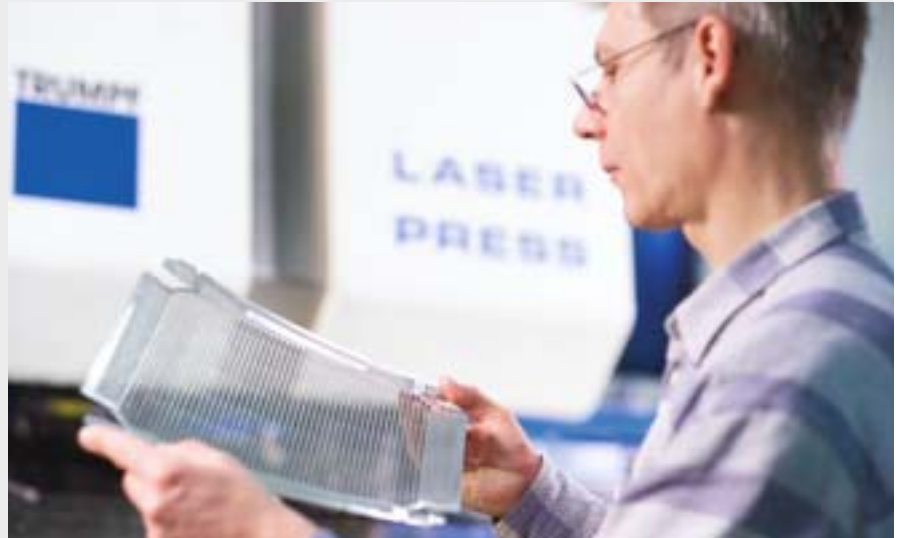

Qualität ohne Kompromisse

Mehr als 40 Jahre Erfahrung in der Sterilgutversorgung führen zu praxisnahen und anwenderfreundlichen Lösungen. Dabei steht die Sterilerhaltung der chirurgischen Instrumente an oberster Stelle.

Aesculap Sterilcontainer entsprechen in allen Komponenten den Anforderungen der nationalen und internationalen Standards zur Sterilverpackung, insbesondere:

- DIN EN ISO 11607
- DIN 58953, Teil 9
- MDD 93/42/EWG

Das solide, robuste Design und die von Aesculap eingesetzten Fertigungstechnologien garantieren ein Höchstmaß an Formgenauigkeit und Stabilität der Sterilcontainer, Instrumentensiebkörbe und anderer Systemkomponenten. In Verbindung mit hochwertigen Materialien wird eine langjährige, nahezu wartungsfreie Funktion der Sterilcontainer ermöglicht.

Reprocessing, Care & Maintenance – Aufbereitung, Pflege und Reinigung



Sterilit® – Oil spray

- Base: paraffin/white oil
- reduces friction and protects against friction corrosion
- ensures good gliding and lubrication characteristics
- suitable for steam sterilization procedures in accordance with ISO 17665-1 and for hot air sterilization up to max. 180°C

Sterilizability

Sterilit®'s special composition guarantees penetration of the oil film by the water vapour during the sterilization process, even in more inaccessible places.

Sterilit® – Pflegeöle

- Basis: Paraffin-/Weißöl
- verringert Reibung und schützt gegen Reibkorrosion
- gewährleistet gute Gleit- und Schmiereigenschaften
- geeignet für Dampfsterilisationsverfahren nach ISO 17665-1 und Heißluftsterilisation bis max. 180°C

Sterilisierbarkeit

Durch die spezielle Rezeptur ist gewährleistet, dass auch in schwer zugänglichen Stellen der Wasserdampf während des Sterilisiervorganges den Ölfilm durchdringt.

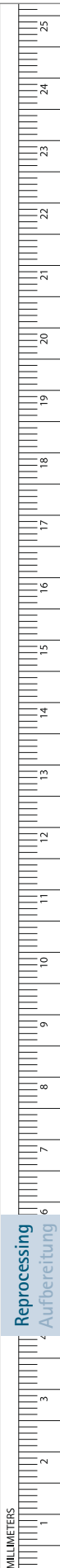

Reprocessing, Care & Maintenance – Aufbereitung, Pflege und Reinigung

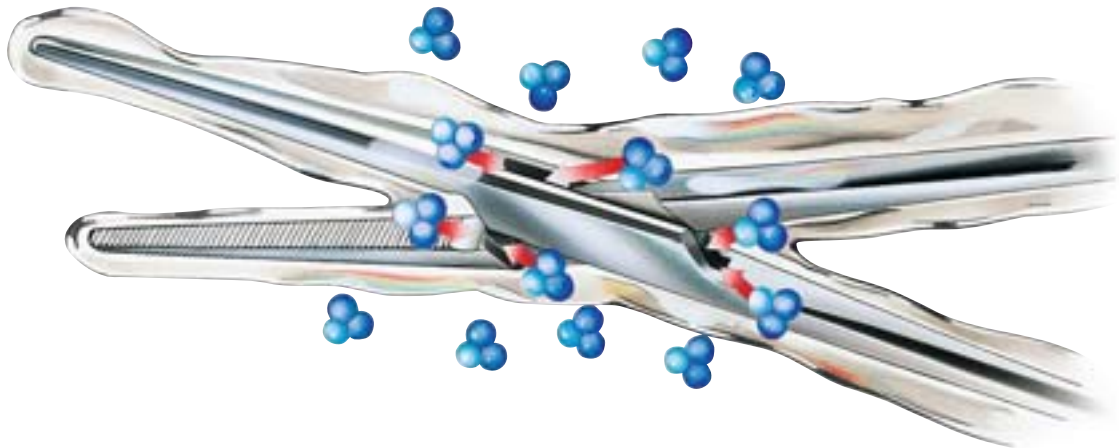

Aesculap maintenance oils Sterilit® I, Sterilit® Power Systems

Applications

All Sterilit® maintenance oils are validated for steam sterilization methods according to ISO 17665-1, as well as for dry heat (heated air) sterilization up to 180°C. They are applied prior to sterilization. (Caution! Motor systems are not suitable for hot air sterilization)

Sterilit®	Art. No.
Sterilit® I, spray	JG600
Sterilit® I, drip oiler	JG598
Sterilit® Power Systems, spray	GB600
Sterilit® Power Systems, drip oiler	GA059

Aesculap maintenance oils Sterilit® I, Sterilit® Power Systems

Einsatzgebiet

Alle Sterilit®-Pflegeöle sind für Dampfsterilisations-Verfahren validiert nach ISO 17665-1 und zur Heißluftsterilisation bis max. 180°C geeignet. Sie werden vor der Sterilisation angewendet. (Achtung: Motorensysteme sind nicht für die Heißluftsterilisation geeignet)

Sterilit®	Art. Nr.
Sterilit® I, Spray	JG600
Sterilit® I, Tropföler	JG598
Sterilit® Power Systems, Spray	GB600
Sterilit® Power Systems, Tropföler	GA059

Reprocessing, Care & Maintenance – Aufbereitung, Pflege und Reinigung

Registration

Sterilit® oils are registered as medical accessory class 1 in conformity with Annex 1 MDD 93/42/EEC CE marking according to directive 93/42/EEC.

Properties

- Steam-permeable oil film
- No adverse effect on the sterilization performance due to the oil film
- Lubricating effect and corrosion protection
- Silicon-free, no staining and incrustation on the instrument surfaces

Biological safety – toxicology

There is no evidence that hazards to the patient will arise during surgical application of Sterilit®-treated devices. This is only valid that the Sterilit® oil is properly and carefully used as described in the instructions for use. According to EN ISO 10993-1.

Safe handling

- Only apply prior to sterilization.
- Store in a cool and dry place protected from light.
- Take note of the use-by date.
- Medical devices must be prepared according to the instructions for use before Sterilit® is applied.

Warning

- Avoid release to the environment.
- Refer to special instructions/safety data sheets.

Registrierung

Sterilit® Öle sind registriert als medizinisches Zubehör der Klasse 1 gemäß Anhang 1 MDD 93/42/EWG; CE-Zeichen gemäß Richtlinie 93/42/EWG.

Eigenschaften

- Wasserdampfdurchlässiger Ölfilm
- Keine Beeinträchtigung der Sterilisationswirkung durch den Ölfilm
- Schmierwirkung und Korrosionsschutz
- Silikonfrei, keine Flecken- und Krustenbildung auf Instrumentoberflächen

Biologische Sicherheit – Toxikologie

Anzeichen für eine Gefährdung des Patienten durch die chirurgische Anwendung von mit Sterilit® behandelten Geräten sind nicht bekannt. Dies gilt nur unter der Bedingung, dass das Sterilit® Öl fachgerecht und sorgfältig eingesetzt wird wie in der Gebrauchsanweisung beschrieben. Nach EN ISO 10993-1.

Sichere Handhabung

- Nur vor der Sterilisation anwenden.
- Kühl, trocken und lichtgeschützt lagern.
- Mindesthaltbarkeitsdatum beachten.
- Vor der Verwendung von Sterilit® müssen Medizinprodukte gemäß Gebrauchsanweisung aufbereitet werden.

Warnung

- Freisetzung in die Umwelt vermeiden.
- Besondere Anweisungen einholen/Sicherheitsdatenblatt zu Rate ziehen.

*Sales unit: **PAK** = Package of 6 pieces
Bestelleinheit: **PAK** = Packung à 6 Stück

					
<p>*JG600 Aesculap® Sterilit® Oil Spray in spray cans for instrument care prior to sterilization Aesculap® Sterilit® Ölspray, in Spraydosen, zur Instrumentenpflege vor der Sterilisation</p>	<p>*GB600 Aesculap® Sterilit® Power Systems Oil Spray in spray cans, for Aesculap power systems care prior to sterilization Aesculap® Sterilit® Power Systems Ölspray, in Spraydosen, zur Pflege von Aesculap Motorensystemen vor der Sterilisation</p>	<p>GB600810 micro-Line</p> <p>GB600820 microspeed uni, HiLAN / HiLAN XS, Hi-Line (XS, XXS)</p>	<p>GB600830 mini-Line</p> <p>GB600840 Acculan 3Ti</p>	<p>GB600870 microspeed uni XS</p>	<p>JG598 Aesculap® Sterilit® instrument oil for lubrication joints and lock prior to sterilization Aesculap® Sterilit® Instrumentenöl, zum Ölen der Schlüsse, Sperren usw. vor der Sterilisation</p> <p>GA059 Aesculap® Sterilit® drip oiler, for lubricating Aesculap motors and handpieces prior to sterilization Aesculap® Sterilit® Tropföler, zum Ölen der Gleitlager an Aesculap Motoren vor der Sterilisation</p>

Reprocessing, Care & Maintenance – Aufbereitung, Pflege und Reinigung

You will find detailed information about the reprocessing of individual Aesculap products in the data base "Reprocessing/Instructions for Use" on the internet:

www.aesculap-extra.net

Ausführliche Informationen zur Aufbereitung individueller Aesculap Produkte finden Sie in der Datenbank „Aufbereitung/Gebrauchsanweisungen“ im Internet unter:

www.aesculap-extra.net

For general information about reprocessing:



Brochure C71002

www.r-k-i.org

Für allgemeine Informationen zur Aufbereitung:



Broschüre C71001

www.r-k-i.org

Index

Index

- Alphabetical Index
- Alphabetischer Index

Alphabetical Index

A – B

	Page		Page
A			
ABRAHAM , tonsil knives	138	Approximators, micro	194
tonsil	135	nerve	195
ACLAND , approximators	196	Applying forceps, clips	193, 194
clip applying forceps	197	Arachnoid blades	369
vessel clips	196	Arteriotomy scissors	416
Adapter, air cartridge, UNITRAC	60	ASH , septum forceps	110
MINOP TREND	63	ATRAUMATA, bulldog clamps	461–463
suction	44	clamps	464, 466, 467
Adapters, light guides	58	dissecting forceps	438, 439, 465
Adenoid curettes	144–146	dissecting forceps, TITANIUM	437
Adenotome blades	147	forceps, micro	180
Adenotomes	147	ligature forceps	465
ADLERKREUTZ , tissue forceps	454	micro forceps	180
ADSON , delicate dissecting forceps	429	organ grasping forceps	495
delicate hemostatic forceps	475	tissue grasping forceps	495
delicate tissue forceps	445, 446	ultra light forceps	436
dissecting forceps, bayonet-shaped	442	vessel clamps, TITANIUM	468, 469
DUROGRIP non-traumatic dissecting forceps	440	AUFRIEHT , bone rasps	240
nerve and vessel hooks	292	nasal retractor	103
raspatories	208, 212	AUSTIN , micro suture tying forceps	177
suction cannulas	531	Awl, bone	239
tissue forceps	447	Awls	239
TITANIUM delicate dissecting forceps	428	B	
ADSON–BABY , self-retaining retractors	282	BABCOCK , organ and tissue grasping forceps	494, 495
ADSON–BROWN , tissue forceps	447	BABY–ADSON , dissecting and ligature forceps	485
AESCULAP , sponge and dressing forceps	345	BABY–ALLIS , dissecting and ligature forceps	492
Air cartridge, CO ₂ , UNITRAC	60	BABY–CRILE (KOCHER) , delicate hemostatic forceps	472
Air cartridge adapter, UNITRAC	60	BABY–CRILE (PEAN) , delicate hemostatic forceps	472
Air shower	8	BABY–CRILE–WOOD , DUROGRIP needle holder	502
Alar retractors	102	BABY–METZENBAUM , dissecting scissors	422
ALEXANDER , bone rongeurs	246	DUROTIP dissecting scissors	384, 387
gouges	227	NOIR dissecting scissors	376
ALLENBERG , carotid retractor	279	Supercut dissecting scissors	395
Alligator forceps	16, 17	BABY–MIKULICZ , peritoneum forceps	491
ALLIS , ATRAUMATA organ and tissue grasping forceps	495	BABY–MIXTER , dissecting and ligature forceps	484
organ and tissue grasping forceps	492, 493	BABY–MOSQUITO (HARTMANN) , delicate hemostatic forceps	470
ALLIS–ADAIR , organ and tissue grasping forceps	492	BABY–OVERHOLT , dissecting and ligature forceps	484
ALLIS–THOMS , organ and tissue grasping forceps	494	BABY–ROUX , retractors	314
ALLPORT , self-retaining retractors	276	BABY–SENN–MILLER , retractors	312
Anatomy scissors	404	BACKHAUS , towel clamps	351
ANGLE , wire cutters	270	BACKHAUS–KOCHER , towel clamps	351
Angular dissecting forceps	444	BALLENGER , septum gouge	105
Antrum curettes	77, 78	swivel knives	96
Antrum grasping forceps	69	Bandage scissors	425, 426
Antrum hooks	30	BANE–HARTMANN , bone rongeurs	245
Antrum punches	66, 67	BARNHILL , adenoid curettes	145
Antrum rasps	79	BARRAQUER , micro needle holders	181
Antrum retractor	78, 331	BARRON , scalpel handles	363
Antrum trocars	79	suction cannulas	537
Application instruments	31	BARTH , bone curettes	216
Applicators, cotton	522–524	BAUMGARTNER , DUROGRIP needle holders	266, 502
Applying forceps, bulldog clamps	459	DUROGRIP wire twisters	266
clips	197		
Approximators	195, 196		

Alphabetical Index

B – C

	Page		Page
Bayonet-shaped dissecting forceps	442, 443	Bone shears	249
DUROGRIP	441	BONNER MODELL , micro suture tying forceps	177
Bayonet-shaped forceps	111	BONNEY , dissecting forceps	435
BEALES , raspatories	38	BOSE , self-retaining retractors	275
BECKMANN , adenoid curettes	144	tracheal retractors	298
nasal speculas	52	BOUCHERON , ear speculas	2
BEEBE , wire cutting scissors	269	Bougies, frontal sinus	80
BELLUCCI , micro scissors	14	BOWMAN , eye probes	521
suction set	528	BOYS-ALLIS , organ and tissue grasping forceps	492
BERGMANN , tracheal retractors	298	BRASKY , skin hooks	297
BERNHARD , towel clamps	351	BRAUN , organ and tissue grasping forceps	133
BEYER , bone rongeurs	246, 247	BRODIE , directors	518
BIEMER , approximator for nerves	195	BROM , vein hook	291
clip applying forceps	193, 194	BROPHY , delicate dissecting forceps	432
micro approximators	194	tissue forceps	450
micro vein scissors	170	BROWN , tissue forceps	447
vessel clips	192	BRUENINGS , septum forceps	71
BIEMER-MUELLER , micro approximators	194	tongue spatulas	116
BILEAU , ear loops	10	tonsil snares	140
Biopsy forceps, micro laryngeal	155	BRUENINGS-BRUNKS , antrum retractor	78, 331
Bipod	132	BRUNS , bone curettes	220
BIRKETT , delicate hemostatic forceps	477	BRYANT , sponge and dressing forceps	343
BISHOP-HARMON , delicate tissue forceps	445	BUCHWALD , tongue spatulas	116
eye forceps	445	BUCK , cotton applicator	523
Blade holder, ERGOPLANT	368	ear curettes	11
Blades, adenotome	147	BUECHS , raspatories	212
arachnoid	369	retractors	335
microsurgical	369	Bulldog clamps	459, 460
scalpel	366, 367	ATRAUMATA	461-463
BLAKESLEY-WILDE , nasal forceps	73	Bulldog scissors	412
BLOHMKE , tonsil forceps	135		
BLUMENTHAL , bone rongeurs	245	C	
BOEHLER , bone cutting forceps	250		
bone rongeurs	247	Cables, light	58, 152
BOETTCHER , tonsil scissors	139	CAIRNS , bone flap elevators	200
BOIES , nasal fracture elevators	111	delicate hemostatic forceps	473
Bone awls	239	dura retractors	294
Bone crusher	109	CAIRNS-DOTT , delicate dissecting forceps	432
Bone curettes	216-222	Calipers	96, 356
ERGOPLANT	218	Cannula heads	544, 545
Bone cutting forceps	248-250	Cannulas	543
ERGOPLANT	248	irrigation	79, 80, 542
Bone files	240, 241	suction	43, 44, 529, 531-540, 542, 543
Bone fixation forceps	252	CANNY-RYALL , retractors	321
Bone flap elevators	200	Carotid retractor	279
Bone holding forceps	252, 253	CARREL , delicate hemostatic forceps	470
Bone mill, cleaner, ERGOPLANT	109	Cartilage forceps	153
micro, ERGOPLANT	109	Cartilage morselizer forceps	111
Bone punches	255-257, 262-265	Cartilage scissors	417
detachable	263	Cartilage slitting knives	97
NOIR	260, 261	CASPAR , exploration hooks	293
Bone rasps	240, 241	raspatories	211
DUROGRIP	99, 242	retractors	336
ERGOPLANT	241	scalpel handle	368
Bone retractors	322, 323		
Bone rongeurs	243-247		

Alphabetical Index

C

	Page		Page
CASPAR, tampers	238	COOLEY, ATRAUMATA clamps	464
CASTROVIEJO, calipers	96	ATRAUMATA dissecting forceps	439
delicate tissue forceps	445	delicate dissecting forceps	433
DUROGRIP needle holders	190, 191	vascular scissors	423
eye forceps	445	COOPER, surgical scissors	409
eye scissors	169	Corneal forceps	429
micro needle holders	183	COTTLE, alar retractors	102
micro scissors	168	bulldog scissors	412
Catheter tube	8	elevators	99, 101
Catheter introducing forceps	355	fishtail osteotomes	106
Catheters, eustachian	8	fixation forceps	111
CAWTHORNE, ear levers	12	mallets	235
ear probe	521	nasal scissors	91
micro grasping forceps	18	nasal speculas	56
micro scissors	15	osteotomes	106
Cerumen Scoops	8, 10	raspatories	99, 101, 211
CHADWICK, delicate scissors	403	septum forceps	110
Chain	120	septum knives	98
CHAPUT, organ and tissue grasping forceps	492	septum speculas	57
Chest supports	132, 151	skin hooks	295
Chisels	108, 223, 225-227, 230, 232, 233	vein retractors	309
flat	42	COTTLE-KNAPP, dissecting scissors	413
CHOMPRET, syndesmotomes	202	COTTLE-MASING, delicate dissecting scissors	413
CINELLI, osteotomes	105	Cotton applicators	522-524
CITELLI, cup forceps	22	CRAIG, septum forceps	95
punches	255	CRAIG-DOMNICK, septum forceps	95
CITELLI-BEYER, punches	255	CRILE, delicate hemostatic forceps	472, 474
Clamping arm	6	nerve and vessel hooks	291
Clamps, ATRAUMATA	464, 466, 467	retractors	315
ATRAUMATA bulldog-	461-463	CRILE-WOOD, DUROGRIP needle holder	502
bulldog-	459, 460	Crimping forceps, implant	39
bulldog, ATRAUMATA	461-463	Crurotomy scissors, micro	15
collumela	111	Crusher, bone	109
towel	351-354	Cup forceps	21, 22, 24
tubing	342, 349, 350	micro	19, 20
Cleaner for bone mill, ERGOPLANT	109	micro laryngeal	154-156
Clip applying forceps	193, 194, 197, 198	Curettes	40, 41
Clips, vessel	192, 196, 198, 458	adenoid	144-146
vessel, non-traumatic	458	antrum	77, 78
Cloth scissors	425, 426	bone	216-222
CO ₂ air cartridge, UNITRAC	60	bone, ERGOPLANT	218
CO ₂ air cartridge adapter, UNITRAC	60	ear	11
COAKLEY, antrum cures	78	frontal sinus	77
COLLER, delicate hemostatic forceps	474	TREND	86-88
COLLIN, ATRAUMATA organ and tissue grasping forceps	495	CUSHING, delicate dissecting forceps	432
organ and tissue grasping forceps	496, 497	DUROGRIP dissecting forceps	441
retractors	316	nerve and vessel hooks	291, 293
sponge holding and dressing forceps	497	tissue forceps	450
tongue forceps	497	vein retractors	310, 311
COLLIN-HARTMANN, retractors	313	CUSHING-KOCHER, vein retractor	310
Collumela clamps	111	CUSHING-LANDOLT, pituitary speculas	81
COLVER, tonsil forceps	134	Cutters, wire	270, 271
Conchotomes	70	Cutting plates, ERGOPLANT	109
Cone knives	364, 366	CZERNY, organ and tissue grasping forceps	133
CONVERSE, DUROGRIP needle holder	501	retractors	320
nasal knives	98		

Alphabetical Index

D

	Page		Page
D			
DANDY, delicate hemostatic forceps	471	Dilators for lacrymal duct	521
DAUBENSPECK, bone curettes	222	Dilators, micro vessel	179
DAUTREY, osteotomes	227	tracheal	274
DAVIES-BOYLE, mouth gags	124	DINGMANN, bone holding forceps	253
tongue spatulas	129	mouth gags	122
DAVIES-MEYER, mouth gags	123	DINGMANN MODIF., bone holding forceps	253
DE BAKEY, arteriotomy scissors	416	Directors	518
ATRAUMATA bulldog clamps	462	Disposable scalpels	360-362
ATRAUMATA clamps	466, 467	Dissecting forceps	434, 435, 475, 477, 484-490
ATRAUMATA dissecting and ligature forceps	465	angular	444
ATRAUMATA dissecting forceps	438, 439	ATRAUMATA	438-440, 465
ATRAUMATA ultra light forceps	436	ATRAUMATA TITANIUM	437
DUROGRIP needle holders	505	bayonet-shaped	442, 443
femur retractors	285	bayonet-shaped, DUROGRIP	441
suction cannulas	538, 539	delicate	429-433
TITANIUM ATRAUMATA dissecting forceps	437	delicate, TITANIUM	428, 431
TITANIUM ATRAUMATA vessel clamps	468, 469	Dia Dust	180
DE BAKEY-HESS, bulldog clamps	460	DUROGRIP	440, 441
DEAN, tonsil scissors	139	micro, Dia Dust	180
DEAVER, surgical scissors	411	Dissecting scissors	412, 418-422, 485
Delicate dissecting forceps	429-433	delicate	398, 399, 406, 412-417
TITANIUM	428, 431	delicate, DUROTIP	383-388
Delicate dissecting scissors	398, 399, 412-417	delicate, NOIR	375, 377-379
DUROTIP	383-388	delicate, wavecut	375, 377-379, 386-388
NOIR	375, 377-379	DUROTIP	382, 383, 385-389
wavecut	375, 377-379, 386-388	micro	171
Delicate tissue forceps, TITANIUM	428	nerve	399, 406, 415
Delicate hemostatic forceps	470-477	NOIR	375-379
Delicate nasal forceps	73	Supercut	394-396
Delicate scissors	397, 400-406	wavecut	377-379, 386-389
DUROTIP	380	Dissecting suction tubes	104, 541
Supercut	392	Dissectors, micro	37
Delicate tissue forceps	431, 445, 446, 448, 449	suction	104
DENIS-BROWNE, tonsil forceps	135	tonsil	136, 137, 541
Depressors, tongue	116	TREND	87, 88
DERF, DUROGRIP needle holder	500	DIXON-LOVELACE, delicate hemostatic forceps	475
Dermal punches	113	DOCKHAM, retractors	336
Dermatomes, spare blades	113	Double ended probes	520
DERRA, ATRAUMATA clamps	464	DOUGHTY, tongue spatulas	130
DESCHAMPS, ligature needles	511-513	DOYEN, directors	518
DESMARRES, vein retractors	309	raspatories	215
Dia Dust, dissecting forceps, micro	180	rib raspatories	215
micro dissecting forceps	180	DOYEN-COLLIN, mouth gags	119
micro needle holders	185-189, 508	DOYEN-JANSEN, mouth gags	119
micro needle holders, TITANIUM	166, 167	DRAFFIN, bipod	132
micro tissue forceps	180	Dressing forceps	342-348, 497
needle holders, micro	185-508	DUNHILL, delicate hemostatic forceps	472, 477
needle holders, micro, TITANIUM	166, 167	DUPLAY, sponge and dressing forceps	344
tissue forceps, micro	180	Dura retractors	294, 297
Diamond knives	371	DURHAM, retractors	333
Diamond rasps	240	DUROGRIP, ATRAUMATA dissecting forceps	440
DIEFFENBACH, bulldog clamps	459	bone rasps	99, 242
DIETER, hammer head punches	23	dissecting forceps	440, 441
DIETHRICH, bulldog clamps	460	dissecting forceps, bayonet-shaped	441
		forceps	266, 441
		micro needle holders	190, 191

Alphabetical Index

D – F

	Page		Page
DUROGRIP , needle holder with scissors	504	Eustachian catheters	8
needle holders	266, 500-503, 505-507, 509, 510	EVES , tonsil snares	140
needle holders, micro	190, 191	tonsil snares, SUSI	140
suture forceps	441	Exploration hooks	293
wire holding forceps	266	Eye forceps	445
wire twisters	266	Eye probes	521
DUROTIP , delicate scissors	380	Eye scissors	169
dissecting scissors	382-389		
ligature scissors	380, 386, 390	F	
scissors	380, 382-390	FAHLBUSCH , micro scissors	83
surgical scissors	381	FARABEUF , raspatories	213
wavecut scissors	386-390	retractors	315
wire cutting scissors	268	FARABEUF-COLLIN , raspatories	213
DUVAL-COLLIN , organ and grasping forceps	496	FARRELL , cotton applicators	522, 524
		FEILCHENFELD , splinter forceps	455
E		Femur retractors	285
Ear curettes	11	FERGUSSON , bone holding forceps	252
Ear hooks	12	suction cannulas	532, 535
Ear levers	10, 12	FERGUSSON-ACKLAND , mouth gags	121
Ear loops	10	FERRIS-SMITH , DUROGRIP dissecting forceps	441
Ear probes	8, 521	FICKLING , hemostatic forceps	482
Ear snares	13	Files, bone	240, 241
Ear specula support	6	round	234
Ear speculas	2-5	Fine retractors	294, 296, 297
Ear tampon forceps	24	FINSEN , self-retaining retractors	275
EAST GRINSTEAD (WARD) , chisels	230	FINSEN MODIF. , self-retaining retractors	275
osteotomes	230	FISCH , dura retractors	297
EICKEN , irrigating cannulas	79	FISHER , tonsil knives	138
Elevators	99-101, 200-203, 208	Fishtail osteotomes	106
bone flap	200	Fistula hooks	307
nasal fracture	111	Fixation device	6
stapes	36	Fixation forceps	111, 352
EMMET , fistula hook	307	Fixing element, flexible	60, 62
Endoscopes	64	Flap knives, micro	32
Enucleation scissors	413	Flat chisels	42
Enucleators, TREND	86, 88	Flexible fixing element	60, 62
ERGOPLANT , blade holder	368	FOERSTER-BALLENGER , sponge holding and dressing forceps	348
bone curettes	218	FOMON , alar retractors	102
bone cutting forceps	248	bone files	241
bone rasp	241	bone rasps	241
cleaner for bone mill	109	lower lateral scissors	413
cutting plates	109	nasal scissors	91
forceps, tissue	428	osteotomes	105
mallets	236	Supercut scissors	393
micro bone mill	109	Footplate hooks, micro	29
mouth wedge, silicone	120	Forceps, alligator	16, 17
raspatories	204	antrum	69
rongeurs	244	applying, bulldog clamps	459
silicone mouth wedge	120	ATRAUMATA dissecting	438-440, 465
soft tissue forceps	428	ATRAUMATA grasping	495
tissue forceps	428	ATRAUMATA ligature	465
tongue retractor	118	ATRAUMATA organ grasping	495
Ethmoidal forceps	72, 74-76	ATRAUMATA tissue grasping	495

Alphabetical Index

F

	Page		Page
Forceps, ATRAUMATA ultra light	436	Forceps, nasal pharyngeal	148
bayonet-shaped	111	nasal tampon	92, 93
bone cutting	248-250	organ grasping	133, 492-497
bone cutting, ERGOPLANT	248	organ grasping, ATRAUMATA	495
bone fixation	252	peritoneum	491
bone holding	252, 253	polypus	160, 497
cartilage	153	removing, bulldog clamps	459
cartilage morselizer	111	reposition	254
catheter introducing	355	rib holding	253
clip applying	193, 194, 197	septum	71, 95, 110
clips	198	sinus	343
corneal	429	soft tissue ERGOPLANT	428
cup	19-22, 24	splinter	455
delicate	73, 429-433, 445, 446, 448, 449	sponge	342
delicate, hemostatic	470-477	sponge holding	348, 497
delicate, TITANIUM	428, 431	spreading	81
Dia Dust	180	suture tying	177, 178
dissecting	434, 435, 475, 477, 484-490	suture, DUROGRIP	441
dissecting, angular	444	tissue	447, 450-454
dissecting, ATRAUMATA	438, 439, 465	tissue grasping	133, 492-497
dissecting, bayonet-shaped	441-443	tissue grasping, ATRAUMATA	495
dissecting, delicate	429-433	tissue, delicate	431, 445-449
dissecting, Dia Dust	180	tissue, Dia dust	180
dissecting, DUROGRIP	440, 441	tissue, ERGOPLANT	428
dressing	342-348, 497	tongue	117, 497
DUROGRIP	440, 441	tonsil	134, 135, 138, 483
DUROGRIP, wire holding	266	tubing	478
ear tampon	24	tubular shaft	153
ethmoidal	72, 74-76	tumor	454
eye	445	tumor grasping	85
fixation	111, 352	ultra light, ATRAUMATA	436
gall duct	490	vascular	454
giraffe	68	wire bending	23
grasping	133	wire holding, DUROGRIP	266
grasping, ATRAUMATA	495	Foreign body instruments	13
grasping, micro laryngeal	156	Forked hooks, triangle handle	301
grasping, organ	133, 492-497	Forks, guide	31
grasping, tissue	133, 492-497	suture	142
grasping, tumor	85	tuning	7
hemostatic	342, 478-483	FORMBY, cerumen scoops	8
hemostatic, delicate	470-477	suction cannulas	536
implant crimping	39	FOWLER, tonsil knives	138
laryngeal	160, 161	FRAENKEL, laryngeal forceps	161
ligature	435, 458, 475, 477, 484-490	laryngeal polypus forceps	160
ligature, ATRAUMATA	465	FRANKFURT, self-retaining retractors	289
micro	18-20, 83, 180	FRASER-KELLY (CRILE), delicate hemostatic forceps	476
micro laryngeal	153	FRAZIER, dura retractors	294
micro laryngeal biopsy	155	suction cannulas	535, 536
micro laryngeal cup	154-156	FREER, chisels	223
micro laryngeal grasping	156	elevators	100, 202
micro, ATRAUMATA	180	gouges	223
micro, dissecting	180	mucous knife	96
micro, jeweler patterns	176	raspatories	100, 101, 202
micro, suture tying	177, 178	skin hooks	295
micro, tissue	180	FREER-YASARGIL, raspatories	100
nasal	73, 94	FRENZEL, nystagmus glasses	6

Alphabetical Index

F – H

	Page		Page
FRENZEL , tongue spatulas	116	Grasping forceps, organ	133, 492-497
FRIEDMANN , bone rongeurs	243	organ, ATRAUMATA	495
Frontal sinus bougies	80	tissue	133, 492-497
Frontal sinus curettes	77	tissue, ATRAUMATA	495
Frontal sinus ostium seeker	80	tumor	85
FUCHSIG , delicate hemostatic forceps	475	GREENE , retractors	334
Furuncle knives	9	GREGORY , atraumatic bulldog clamps	463
		GREY-TURNER , delicate hemostatic forceps	477
		Grindstones	234
		GROSS , sponge and dressing forceps	344
		GRUBER , ear speculas	3
		GRUENWALD , dissecting forceps, bayonet-shaped	443
		DUROGRIP dissecting forceps, bayonet-shaped	441
		GRUENWALD-HENKE , conchotomes	70
		Guide forks	31
		Guide needles	525
		Guide probes	514, 515
		Guides, light	58, 152
		GUILFORD-WRIGHT , wire scissors	268
		GUTHRIE , skin hooks	294
		GWYNNE-EVANS , tonsil dissector	137
G		H	
Gags, mouth	119, 121-124	HAASE , reposition forceps	254
Gall duct forceps	490	HAJEK , irrigation cannulas	80
GALLAHER , bone rasps	240	mallets	237
GAST , tongue spatulas	127	osteotomes	320
GELPI , skin retractors	285	HAJEK-KOFLER , punches	256, 257
GEMINI , dissecting and ligature forceps	487	HAKANSSON , bone rongeurs	245
GERALD , delicate dissecting forceps	431	HALLE , bone curettes	222
delicate tissue forceps	431, 449	elevators	202
TITANIUM delicate dissecting forceps	431	raspatories	202
TITANIUM delicate tissue forceps	431	HALSEY , DUROGRIP needle holder	500, 501
GIERTZ-STILLE , rib shears	251	HALSTED , delicate hemostatic forceps	475, 476
GILLIES , delicate dissecting forceps	431	HALSTED-MOSQUITO , delicate hemostatic forceps	470, 476
delicate tissue forceps	449	Hammer head punches	23
DUROGRIP needle holder with scissors	504	Handles	42
skin hooks	296	irrigation/suction, MINOP TREND	63
osteotomes	225	laryngeal instruments	159
suction cannulas	531	mirror	150
Giraffe forceps	68	scalpel	363-365, 368, 369
Glasses, nystagmus	6	suction	43
GLATZEL , nasal mirrors	96	tonsillotome	143
Glomus spreader	286	HARDY , TREND curettes	86-88
GLOVER , ATRAUMATA bulldog clamps	462	TREND enucleators	86, 88
GLUCK , rib shears	251	HARTMANN , conchotomes	70
GOELET , retractors	321	cup forceps	21, 22
GOLDMAN-FOX , DUROTIP delicate scissors	380	ear speculas	2-4
Supercut scissors	393	ear tampon forceps	24
GOLDMANN , nasal fracture elevators	111	eustachian catheters	8
GOOD , tonsil scissors	139	grasping forceps	18
GORNEY , delicate dissecting scissors	417	nasal speculas	51, 53, 54
suction dissector	104	nasal tampon forceps	93
Supercut dissecting scissors	396		
GOSLEE , wire bending pliers	267		
Gouges	223, 225-227, 231-233		
septum	105, 107		
GRAEFE , delicate dissecting scissors	412		
nerve and vessel hooks	290		
skin hooks	294		
tissue forceps	447		
Grasping forceps	16		
antrum	69		
ATRAUMATA, organ	495		
ATRAUMATA, tissue	495		
micro	18		
micro laryngeal	156		

Alphabetical Index

H – J

	Page		Page
HARTMANN , tongue spatulas	118	Hooks, thyroid	311
tonsil punches	143	vein	291
tuning forks	7	vessel	12, 290-293
HARTMANN-HALLE , nasal speculas	51	HOUGH , grasping forceps	18
HARTMANN-WULLSTEIN , cup forceps	21	HOUSE , curettes	40, 41
grasping forceps	18	suction adapter	44
HARVEY , wire cutting scissors	268	suction and irrigation cannulas	542
HEERMANN , flat chisels	42	HOWARD , raspatories	101
gouges	42	HUDSON , delicate dissecting forceps	429
handles	42	tissue forceps	447
mallets	42	HUGHES , stapes mobilisators	31
HEGAR-MAYO , DUROGRIP needle holder	503	HUNTER , splinter forceps	455
HEGAR-MAYO-SEELEY , DUROGRIP needle holder	503	HURD , ligature needles	513
HEGAR-OLSEN , DUROGRIP needle holder with scissors	504	tonsil dissector	136
HEGAR-OLSEN MODIF. LANGE , DUROGRIP needle holder with scissors	504		
HEISS , delicate hemostatic forceps	477	I	
dissecting and ligature forceps	477	Implant crimping forceps	39
HEISTER , mouth gags	119	Incision scissors	411
HEMINGWAY , bone curettes	218, 219	Instruments, foreign body	13
Hemostatic forceps	342, 478-483, 496	ligature	142
delicate	470-477	measuring	39
HENCKEL-TILLEY , rongeurs	74	Irrigating cannulas	79, 80, 542
HENKE , tonsil dissector	136	Irrigation handles, MINOP TREND	63
HENKEL , cup forceps	24	Irrigation shafts, MINOP TREND	64
HEYMANN , nasal scissors	90	Irrigation tubes, MINOP TREND	63
HEYMANN-KNIGHT , nasal scissors	90		
septum forceps	95	J	
HEYWOOD-SMITH , organ- and tissue grasping forceps	497	JACOBSON , bone curettes	216
sponge holding and dressing forceps	497	delicate hemostatic forceps	471, 476
tongue forceps	497	micro needle holders	183
HEYWOOD-SMITH MODIF. , organ- and tissue grasping forceps	497	micro scissors	171
sponge holding and dressing forceps	497	JAEGER , skin hooks	296
tongue forceps	497	JAMESON , delicate dissecting scissors	415
HILL , raspatories	101	Supercut scissors	393
HOESEL , DUROGRIP needle holder	510	JAMESON-WERBER , delicate dissecting scissors	415
Holders, laryngoscope	151	JANSEN , bone curettes	216, 218
needle	181-185, 501	bone rongeurs	245, 246
needle with scissors, DUROGRIP	504	dissecting forceps, bayonet-shaped	442
needle, Dia Dust	185-189, 508	raspatories	210, 211
needle, Dia Dust, TITANIUM	166, 167, 508	self-retaining retractors	276
needle, DUROGRIP	190, 191, 500-503, 505-507, 509, 510	JANSEN-MIDDLETON , nasal forceps	94
Holding arm	62	JATHO , nasal pharyngeal forceps	148
Hooks, antrum	30	JEFFERSON , delicate dissecting forceps	429
ear	12	delicate tissue forceps	446
exploration	293	self-retaining retractors	284
fistula	307	JOBSON-HORNE , ear probes	8
footplate	29	JOHNS-HOPKINS , bulldog clamps	459
micro	27-30, 158	applying and removing forceps	459
nasal	103	JOLL (FRIEDMAN) , thyroid retractors	287
nerve	12, 290-293	JOSEPH , bone files	240
parotis	308		
skin	294-297		
tendon	308, 309		
triangle handle	301, 304		
TREND	87, 88		

Alphabetical Index

J – L

	Page		Page
JOSEPH , delicate scissors	397, 406	Knives, sickle	9, 77, 158
iris scissors	397	skin grafting	113
nasal knives	97, 98	swivel	96
nasal saws	99	tonsil	138
raspatories	209	KOCHER , bone retractors	322
skin hooks	296	guide probes	515
retractors	296	hemostatic forceps	480
Supercut dissecting scissors	394	retractors	322, 331, 337
JUDD-ALLIS , organ and tissue grasping forceps	494	vein retractors	310
JURASZ , laryngeal polypus forceps	160	KOCHER-LANGENBECK , retractors	327
nasal pharyngeal forceps	148	KOCHER-OCHSNER , hemostatic forceps	481
K		KOENIG , elevators	200, 208
KANTROWITZ , dissecting and ligature forceps	489	guide probes	514
KAYE , Supercut dissecting scissors	396	raspatories	208
KAZANJIAN , bone cutting forceps	248	vein retractors	310
KELLY , delicate hemostatic forceps	471	KOFLER , punches	257
delicate scissors	406	KRAEMER , raspatories	214
KERRISON , punches	255, 260-265	retractors	335
punches, detachable	263	KRAUSE , ear snares	13
punches, NOIR	260	nasal polypus snares	112
KEYES , dermal punches	113	KRAUSE-VOSS , nasal polypus snares	112
KILLIAN , bone shears	249	KRAYENBUEHL , nerve and vessel hooks	292
laryngectomy scissors	161	KROENLEIN , hemostatic forceps	342
nasal probe	521	KRONECKER , ligature needles	511
nasal speculas	55, 56	L	
raspatories	100	LA FORCE , adenotome blades	147
septum gouge	107	adenotomes	147
KILLIAN-CLAUS , septum gouge	107	LA GRANGE , delicate scissors	405
KILNER , delicate dissecting scissors	412, 415	LABORDE , tracheal dilators	274
DUROGRIP needle holder	502	LACK , tongue spatulas	117
fine retractors	297	Lacrimal duct, dilators for	521
retractors	312, 318	LAHEY , organ and tissue grasping forceps	133
skin hooks	295	retractors	332
KINGS' COLLEGE HOSPITAL , cotton applicators	523	LAHEY (SWEET) , dissecting and ligature forceps	490
KIRSCH , retractors	333	gall duct forceps	490
KIRSTEIN , nasal scissors	90	LAMBOTTE , osteotomes	228, 230
KLAPP , tendon hook	308	Lamps, replacement	6
KLEINERT-KUTZ , skin hooks	295	LANDOLT , dissecting suction tube	104, 541
KLINIKUM BERLIN , tubing clamps	349	enucleation scissors	413
Knives, cartilage slitting	97	raspatories	211
cone	364, 366	scalpel handle	369
diamond	371	spreading forceps	81
dura	98	tumor grasping forceps	85
flap	32	LANDOLT-REULEN , TREND dissectors	87, 88
furuncle	9	TREND hook	87, 88
laryngeal micro	158	LANE , tissue forceps	453
laryngeal sickle	158	LANGE , fistula hook	307
micro	31-35, 158	LANGENBECK , bone holding forceps	252
mucous	96	DUROGRIP needle holder	509
nasal	97, 98	ear loops	10
round cutting	33-35, 158	elevators	201
septum	98	raspatories	213, 214

Alphabetical Index

L – M

	Page		Page
LANGENBECK , retractors	326	LOCKLIN , delicate scissors	405
rib raspatories	214	LOCKWOOD , organ and grasping forceps	496
wire bending forceps	267	Loops, ear	10
LANGENBECK-GREEN , retractors	305	wire	13, 112, 141
LANGENBECK-MANNERFELT , retractors with triangle handle	303	LOPEZ-REINKE , tonsil dissector	541
Laryngeal forceps	161	LORNA , towel clamps	353
micro	153	Lower lateral scissors	413
Laryngeal instruments, handle for	159	LOWER , dissecting and ligature forceps	490
Laryngeal micro biopsy forceps	155	gall duct forceps	490
Laryngeal micro cup forceps	154-156	LUBET , nasal tampon forceps	92
Laryngeal micro grasping forceps	156	LUC , septum forceps	71
Laryngeal micro knives	158	LUCAE , dissecting forceps, bayonet-shaped	442
Laryngeal micro scissors	155	ear levers	12
Laryngeal micro separators	158	paracentesis needles	9
Laryngeal micro suture guide	158	tuning forks	7
Laryngeal mirrors	150	LUCAS , bone curettes	219
Laryngeal needle holders	157	chisels	227
Laryngeal polypus forceps	160	ERGOPLANT bone curettes	218
Laryngeal sickle knives	158	gouges	227
Laryngectomy scissors	161	LUER , bone rongeurs	244, 245
Laryngoscope holder	151	retractors	314
Laryngoscopes, operating	151	LUER-FRIEDMANN , bone rongeurs	243
LATHEBURY-FARRELL , cotton applicators	522-524	ERGOPLANT rongeurs	244
LAZAR , micro suture tying forceps	177	Lupus spatulas	98
LELOND-JONES , ATRAUMATA clamps	467		
LEMPERT , bone curettes	221		
bone rongeurs	246		
raspatories	38, 208		
suction cannulas	536		
LERICHE , delicate hemostatic forceps	473		
Levers, ear	10, 12		
LEWIS , bone rasps	240		
LEXER , dissecting scissors	420		
DUROTIP dissecting scissors	383, 386		
gouges	233		
NOIR dissecting scissors	379		
osteotomes	233		
LEXER-MINI , gouges	232		
osteotomes	232		
LICHTENBERG , DUROGRIP needle holder	510		
Ligature forceps	435, 458, 475, 477, 484-490		
ATRAUMATA	465		
Ligature instruments	142		
Ligature needles	158, 511-513		
Ligature scissors	424		
DUROTIP	380, 386, 390		
NOIR	375		
wavecut	375, 386, 390		
Light cable adapters	58		
Light cables	58, 152		
Light guide adapters	58		
Light guides	58, 152		
LISTER , bandage and cloth scissors	425, 426		
sinus forceps	343		
LISTON , bone cutting forceps	249		
LITTLER , delicate dissecting scissors	412		
		M	
		MAC DONALD , raspatories	100
		MAGAURAN , bipod	132
		MAGILL , catheter introducing forceps	355
		suction cannulas	538
		MAIER , sponge and dressing forceps	346
		Mallets	42, 235-237
		ERGOPLANT	236
		spare discs	235-237
		MALTZ , bone rasps	240
		MANNERFELT MODIF. , forked hook with triangle handle	301
		gouges	223
		osteotomes	223
		raspatories	207
		retractors with triangle handle	301, 303
		saddle hook with triangle handle	304
		MARBURG MODELL , wire bending pliers	267
		MARQUARDT , bone rongeurs	247
		MARTINI , bone curettes	216
		MASING , cartilage slitting knives	97
		DUROGRIP needle holder	501
		elevators	99
		osteotomes	105
		raspatories	99
		vein retractors	309
		MATHIEU , DUROGRIP needle holder	510
		retractors	320
		MAYFIELD , bone rongeurs	247

Alphabetical Index

M

	Page		Page
MAYO , dissecting scissors	418, 419, 421	Micro perforators	26
DUROTIP dissecting scissors	382, 386	Micro raspatories	36-38
NOIR dissecting scissors	378	Micro round cutting knives	33-35, 158
Supercut dissecting scissors	394	Micro scalpel handles	368, 369
surgical scissors	418	Micro scalpels	362
MAYO-LEXER , dissecting scissors	420	Micro scissors	14, 15, 65, 83, 84, 168-175
DUROTIP dissecting scissors	383, 387	Micro separators, laryngeal	158
NOIR dissecting scissors	379	Micro suture guide, laryngeal	158
MAYO-STILLE , dissecting scissors	418, 419	Micro suture tying forceps	177, 178
surgical scissors	418	Micro tissue forceps, Dia Dust	180
MC CLURE , micro scissors	168	Micro vein scissors	170
MC INDOE , bone cutting forceps	250	Micro vessel dilators	179
chisels	108	Micro, scrapers	30
delicate dissecting forceps	431	MICRO-ADSON , delicate dissecting forceps	429
delicate tissue forceps	449	delicate tissue forceps	445, 446
skin hooks	295	dissecting and ligature forceps	484
MC IVOR , tongue spatulas	123, 128	TITANIUM delicate dissecting forceps	428
MC KENTY , raspatories	208	TITANIUM delicate tissue forceps	428
MC KISSOCK , raspatories	214	MICRO-ADSON-BIEMER , delicate tissue forceps	445
MEAD , bone rongeurs	246	MICRO-HALSTED , delicate hemostatic forceps	470
mallets	235	Microsurgical blades	369
Measuring instruments	39	MIDDELDORPF , retractors	334
MEHDORN , clip applying forceps	193	MIKULICZ , hemostatic forceps	483
vessel clips	192	organ and tissue forceps	491
METZENBAUM , delicate dissecting scissors	398	tonsil forceps	483
dissecting scissors	388, 422	MILLER , bone curettes	216
DUROTIP dissecting scissors	385, 388, 389	bone rasps	241
NOIR delicate dissecting scissors	377, 378	ERGOPLANT bone rasps	241
NOIR dissecting scissors	376-378	grasping forceps	16
Supercut dissecting scissors	395	MILLES , micro scissors	171
MEYERDING , retractors	306	MINOP TREND , adapter	63
Micro approximators	194	irrigation/suction handles	63
Micro bone mill, ERGOPLANT	109	irrigation/suction shafts	64
Micro crurotomy scissors	15	irrigation/suction tubes	63
Micro cup forceps	19, 20	scopes	64
Micro dissecting forceps, Dia Dust	180	storage tray	63
Micro dissecting scissors	171	Mirror handles	150
Micro dissectors	37	Mirrors, laryngeal	150
Micro flap knives	32	nasal	96
Micro footplate hooks	29	MIXTER , dissecting and ligature forceps	490
Micro forceps	83, 180	MIXTER-O'SHAUGNESSY , dissecting and ligature forceps	488
ATRAUMATA	180	Mobilisators, stapes	31
jeweler patterns	176	MODELL PICCOLO , cotton applicators	522
Micro hooks	27, 28, 30, 158	MOLLISON , self-retaining retractors	284
Micro knives	31	tonsil dissector	137
laryngeal	158	MOLT , mouth gags	119
Micro laryngeal biopsy forceps	155	raspatories	205
Micro laryngeal cup forceps	154-156	MORITZ-SCHMIDT , tongue depressors	116
Micro laryngeal forceps	153	MORSE , nerve dissecting scissors	406
Micro laryngeal grasping forceps	156	Morselizer forceps, cartilage	111
Micro laryngeal scissors	155	Mouth gags	119, 121-124
Micro needle holders	181-184	Mouth wedge, silicone, ERGOPLANT	120
Dia Dust	185-189, 508	MOYNIHAN , delicate hemostatic forceps	473
Dia Dust, TITANIUM	166, 167	Mucous knives	96
DUROGRIP	190, 191	MUEHLING , bone shears	249
Micro needles	25	raspatories	211

Alphabetical Index

M – P

	Page		Page
MUELLER , ligature forceps	458	NELSON-METZENBAUM , DUROTIP dissecting scissors	389
micro needle holders	184	Nerve approximators	195
micro scissors	172	spare needles	195
non-traumatic vessel clips	458	Nerve dissecting scissors	415
skin hooks	295	delicate	399
vessel clips	458	Nerve hooks	12, 290-293
MURPHY , retractors	325	NICOLA , micro forceps	83
MUSEUX , organ and tissue grasping forceps	133	micro scissors	83
MUSGROVE , cerumen scoops	10	TREND curettes	86, 88
MYLES , conchotomes	70	NISSEN , delicate hemostatic forceps	475
Myringotomes	9	dissecting and ligature	475
Myrtle leaf probes	519	NOIR , bone punches	260, 261
		dissecting scissors	375-379
		ligature scissors	375
		scissors	375-379
		wavecut scissors	375, 377-379
		Non-traumatic vessel clips	458
N		NORTHBENT , ligature scissors	424
NAGER , tonsil forceps	138	NOYES , micro scissors	168
Nail scissors	400	Nurse's scissors	425
Nasal forceps	73, 94	Nystagmus glasses	6
Nasal fracture elevators	111		
Nasal hook	103	O	
Nasal knives	97, 98	OBWEGESER , awls	239
Nasal mirrors	96	chisels	233
Nasal olives	8	raspatories	212
Nasal pharyngeal forceps	148	retractors	329, 330
Nasal polypus snares	112	OBWEGESER-FREER , elevators	203
Nasal probes	521	OCHSNER , ligature forceps	435
Nasal retractors	103	OFFICER , tissue forceps	453
Nasal saws	99	Oil spray, STERILIT	555
Nasal scissors	65, 90, 91	Oil, STERILIT	234, 555
Nasal speculas	50-59	OLDBERG , rongeurs	85
Nasal suction tubes	537	Olives, nasal	8
Nasal tampon forceps	92, 93	Operating laryngoscopes	151
Needle holders, Dia Dust, micro	185-189, 508	Organ grasping forceps	133, 492-497
Dia Dust, micro, TITANIUM	166, 167	ATRAUMATA	495
DUROGRIP	266, 500-510	ORMEROD , cup forceps	22
DUROGRIP, micro	190, 191	Orthodontic pliers	267
laryngeal	157	O'SHAUGNESSY , dissecting and ligature forceps	488, 489
micro	181-184	Osteotomes	105-107, 223, 225-228, 230-233, 320
micro, Dia Dust	185-189, 508	fishtail	106
micro, Dia Dust, TITANIUM	166, 167	OSTROM , antrum punches	66
micro, DUROGRIP	190, 191	OVERHOLT , dissecting and ligature forceps	487
TITANIUM	166, 167, 508	OVERHOLT-GEISSENDOERFER , dissecting and ligature forceps	486
with scissors, DUROGRIP	504	OVERHOLT-MIXTER , dissecting and ligature forceps	486
Needles, guide	525		
ligature	158, 511-513	P	
micro	25	Pad forceps, ear	24
paracentesis	9	nasal	92, 93
NEGUS , adenoid curettes	145		
chest support	132		
hemostatic forceps	483		
suction dissector	104		
suture forks	142		
tonsil forceps	483		
NELATON , directors	518		

Alphabetical Index

P – R

	Page		Page
Pads, silicone	123	Probes, ear	8, 521
Palate plates	123	eye	521
PAPAVERO, spreader	82	guide	514, 515
PAPAVERO-CASPAR, pituitary speculas	82	myrtle leaf	519
Paracentesis needles	9	nasal	521
PARKER, retractors	314, 316	rectal	518, 520
Parotis hook	308	sinus	520
PARTSCH, chisels	226	tendon passing	519
gouges	226	with eye	519
raspatories	208	PROVIDENCE-HOSPITAL, delicate hemostatic forceps	471
PARTSCH MOD. LANGE, raspatories	208	Punches, antrum	66, 67
PASSOW, tampers	238	bone	255-257, 262-265
PAUL, tendon hook	308	bone, detachable	263
PAYR, guide probes	515	bone, NOIR	260, 261
PEAN, hemostatic forceps	342	dermal	113
sponge and dressing forceps	342	hammer head	23
tubing clamps	342	sinus	66
tubing forceps	478	tonsil	143
PEET, splinter forceps	455		
PENNINGTON, grasping forceps	496	Q	
organ and tissue grasping forceps	496	QUERVAIN, elevators	201
raspatories	99	QUIRE, foreign body instruments	13
PENNYBAKER, raspatories	214		
Perforators, micro	26	R	
Peritoneum forceps	491	Racks, storage	45
PERKINS, self-retaining retractors	282	RAGNELL, delicate dissecting scissors	399
PERWITZSCHKY, salival scissors	404	retractors	315
Picks, tissue	297	RAMPLEY, sponge holding and dressing forceps	348
Pituitary speculas	81, 82	RAMSEY, dissecting forceps	435
Plates, palate	123	RANKIN, delicate hemostatic forceps	474
PLESTER, antrum hooks	30	Raspatories	38, 39, 100, 101, 202, 205, 207-215
micro flap knives	32	ERGOPLANT	204
micro footplate hooks	29	micro	36-38
micro scrapers	30	rib	214, 215
raspatories	210	suction	104
self-retaining retractors	280, 281	Rasps, antrum	79
suction cannulas	43, 532	bone	240, 241
suction set	43	bone, DUROGRIP	99, 242
PLESTER-HELMS, self-retaining retractors	280	bone, ERGOPLANT	241
Plexiglass bar	234	diamond	240
Pliers, orthodontic	267	DUROGRIP	99, 242
wire bending	267	Reamers	239
wire cutting	271	Rectal probes	518, 520
POLITZER, air shower	8	REDON, guide needles	525
ear speculas	2	REILL, micro needle holders	182
furuncle knives	9	reposition forceps	254
paracentesis needles	9	wire cutting pliers	271
sickle knives	9	Removing forceps, applying forceps	459
Polypus forceps	497	Replacement lamps	6
laryngeal	160	Reposition forceps	254
Polypus snares, nasal	112		
POTTS, delicate dissecting scissors	416		
POTTS-SMITH, vascular scissors	423		
Preparation trays	39		
Probes	520, 521		
double ended	520		

Alphabetical Index

R – S

	Page		Page
Retractors	103, 305, 306, 312-337	S	
alar	102	Saddle hooks, with treangle handle	304
antrum	78, 331	Safety scalpels, single use	358, 359
bone	322, 323	Salival scissors	404
carotid	279	SAROT, DUROGRIP needle holder	503
dura	294, 297	SAUERBRUCH , retractors	332
femur	285	rib shears	251
fine	294, 296, 297	Saws, nasal	99
nasal	103	Scalpel blades	366, 367
self-retaining	275-284, 289	microsurgical	369
skin	285, 297	Scalpel handles	363-365, 368, 369
thyroid	287	Scalpels, disposable	360-362
tongue, ERGOPLANT	118	micro	362
tracheal	298-300	safety, single use	358, 359
vein	309-311	SCHEDE , bone curettes	220
with treangle handle	301, 303, 304	SCHINK , skin grafting knives	113
REYNOLDS , delicate dissecting scissors	416	SCHMIEDEN , guide probes	514
REYNOLDS-JAMESON , delicate dissecting scissors	399	SCHNIDT , hemostatic forceps	483
Rib holding forceps	253	tonsil forceps	483
Rib raspatories	214, 215	SCHOENBORN , vein retractors	311
Rib shears	251	SCHUHKNECHT , micro round cutting knives	35
RITTER , frontal sinus bougies	80	suction cannulas	537
RNTNE-HOSPITAL , self-retaining retractors	282	SCHWARTZ , clip forceps	198
ROBERTS , raspatories	205	vessel clips	198
ROBIN , towel clamps	352	SCHWECKENDICK , tonsil scissors	139
ROCHESTER-CARMALT , hemostatic forceps	482	SCHWEDISCHES MODELL , dissecting forceps	435
ROCHESTER-OCHSNER , hemostatic forceps	480	Scissors, anatomy	404
ROCHESTER-PEAN , hemostatic forceps	479	arteriotomy	416
ROEDER , ligature instruments	142	bandage	425, 426
towel clamps	351	bulldog	412
ROLLET , skin hooks	294	cartilage	417
Rongeurs	72-76, 85	cloth	425, 426
bone	243-247	crurotomy	15
ERGOPLANT	244	delicate	397, 400-406, 412
ROSE , retractors	314	delicate, dissecting	398, 399, 406, 412-417
ROSEN , ear speculas	4, 5	delicate, DUROTIP	380, 383-388
micro flap knives	32	delicate, NOIR	375, 377-379
micro needles	25	delicate, wavecut	375, 377-379, 386-388
ROSER-KOENIG , mouth gags	121	dissecting	406, 412, 418-422
Round cutting knives	158	dissecting, delicate	398, 399, 412-417
micro	33-35	dissecting, DUROTIP	382-389
Round files	234	dissecting, micro	171
Round knives	35	dissecting, NOIR	375-379
ROUX , retractors	317, 319	dissecting, Supercut	394-396
ROWBOTHAM , suction cannulas	538	dissecting, wavecut	375, 377-379, 386-389
Rulers	356	DUROTIP	268, 380-390
RUSKIN , bone rongeurs	247	enucleation	413
RUSKIN-LISTON , bone cutting forceps	250	eye	169
RUSS. MODELL , tissue forceps	454	incision	411
RUSSEL-DAVIS , tongue spatulas	125, 126	laryngectomy	161
RYDEL-SEIFFER , tuning forks	7	ligature	424
RYDER , Dia Dust micro needle holder	508	ligature, DUROTIP	380, 386, 390
DUROGRIP needle holder	506, 507	ligature, NOIR	375
TITANIUM Dia Dust needle holder	508	ligature, wavecut	375, 386, 390
		lower lateral	413

Alphabetical Index

S

	Page		Page
Scissors, micro	14, 15, 65, 83, 84, 168-175	Sickle knives	9, 77
micro laryngeal cup	155	laryngeal	158
micro, dissecting	171	Silicone mouth wedge, ERGOPLANT	120
micro, vein	170	Silicone pads	123
nail	400	Silicone tubes, spare	119
nasal	65, 90, 91	SILVER , skin grafting knives	113
nerve	399, 406	SIMON , fistula hook	307
nerve dissecting	415	SIMS-MAIER , sponge and dressing forceps	347
NOIR	375-379	Single use, safety scalpels	358, 359
nurse's	425	scalpels	360, 362
salival	404	Sinus forceps	343
septum	91	Sinus probes	520
strabismus	398	Sinus punches	66
Supercut	392, 393	Sinuscopy trocar	80
Supercut-, delicate	392	Skin grafting knives	113
surgical	407-411, 418	Skin hooks	294-297
surgical, DUROTIP	381, 382	Skin retractors	285
tendon	414	SLUDDER-BALLENGER , tonsillotome handle	143
tonsil	139	tonsillotomes	143
vascular	414, 423	Snare wires	141
vein, micro	170	Snares, ear	13
wavecut	375, 377-379, 386-390	nasal polypus	112
wire	268	tonsil	140, 142
wire cutting	268, 269	Spare blades, dermatomes	113
wire cutting, DUROTIP	268	Spare discs, mallet	235-237
Scoops, cerumen	8, 10	Spare needles, nerve approximator	195
Scopes	64	Spare silicone tubes	119
Scrapers, micro	30	Spatulas, lupus	98
SEBILEAU , elevators	201	tongue	116-118, 123, 125-131, 522
SEDILLOT , raspatories	213	Speculas, ear	2-5
Seeker, frontal sinus ostium	80	nasal	50-59
SEIFFERT , probes	521	pituitary	81, 82
SELDIN , raspatories	205	septum	57
Self-retaining retractors	275-284, 289	SPENCER , ligature scissors	424
SELMAN , tissue forceps	454	SPENCER-WELLS , hemostatic forceps	478
SEMB , bone holding forceps	253	Splinter forceps	455
rib holding forceps	253	Sponge forceps	342-347
SEMKEN , delicate dissecting forceps	431	Sponge holding forceps	348, 497
delicate tissue forceps	448	Spray, oil, STERILIT	555
SENN-MILLER , retractors	312	Spreader	82
Separators, laryngeal micro	158	Spreaders, glomus	286
Septum forceps	71, 95, 110	Spreading forceps	81
Septum gouges	105, 107	ST. BARTS , ear hooks	12
Septum knives	98	rongeurs	74, 75
Septum scissors	91	ST. CLAIR-THOMPSON , adenoid currettes	146
Septum speculas	57	nasal speculas	50
Sets, suction	43, 528	ST. MARTIN , delicate tissue forceps	445
SEWALL , elevators	202	eye forceps	445
raspatories	202	STACKE , ear probe	521
Shafts, irrigation/suction, MINOP TREND	64	STAMM , bone cutting forceps	248
SHAMBAUGH , micro hooks	27, 28	STAMMBERGER , antrum punches	67
SHEA , currettes	40	STANDARD , DUROGRIP dissecting forceps	441
ear speculas	5	Stapes elevators	36
Shears, bone	249	Stapes mobilisators	31
rib	251	STELLBRINK , bone rongeurs	243
Shower, air	8	Sterile drape for UNITRAC arm	61

Alphabetical Index

S – T

	Page		Page
Sterile scalpels	358-362	T	
STERILIT, oil	234, 555	TAKAHASHI, rongeurs	75, 76
oil spray	555	Tampers	238
STERNBERG, retractors	313	Tampon forceps, ear	24
STEVENS, delicate dissecting scissors	398, 414	nasal	92, 93
Supercut scissors	392	Teeth protector	152
vascular and tendon scissors	414	Tendon hooks	308, 309
Stich cutters	367	Tendon passing probes	519
STIEGLITZ, splinter forceps	455	Tendon scissors	414
STILLE, chisels	230	TESSIER, osteotomes	226
dissecting scissors	420	Test strips	234
gouges	231	THOREK, vascular scissors	423
osteotomes	231	THORPE, corneal forceps	429
STILLE-BARRAYA, vascular and tumor forceps	454	delicate dissecting forceps	429
Stitch cutters	367	Thyroid hook	311
Storage racks	45	Thyroid retractors	287
Storage tray, MINOP TREND	63	TIECK-HALLE, nasal speculas	52, 57
Strabismus scissors	398	TILLEY, ear tampon forceps	24
STRANDELL-STILLE, tendon hook	309	nasal tampon forceps	92
STRASSBURGER MODELL, tissue forceps	454	TILLEY-LICHTWITZ, antrum trocars	79
Strips, test	234	Tissue forceps	447, 450-454
STRUYCKEN, conchotomes	70	delicate	431, 445, 446, 448, 449
Suction adapter	44	Dia Dust	180
Suction cannulas	43, 44, 529, 531-540, 542, 543	ERGOPLANT	428
Suction dissectors	104	micro, Dia Dust	180
Suction handles	43	Tissue grasping forceps	133, 348, 492-497
MINOP TREND	63	ATRAUMATA	495
Suction raspatories	104	Tissue pick	297
Suction sets	43, 528	Tissue, forceps	451-454
Suction shafts, MINOP TREND	64	TITANIUM, ATRAUMATA dissecting forceps	437
Suction tubes	528	ATRAUMATA vessel clamp	468, 469
dissecting	104, 541	delicate dissecting forceps	428, 431
MINOP TREND	63	delicate tissue forceps	428
nasal	537	dissecting forceps, delicate	428, 431
Supercut, delicate scissors	392	Dia Dust micro needle holders	166, 167
dissecting scissors	394-396	needle holder	508
scissors	392-396	tissue forceps, delicate	428
Supports, ear specula	6	TOBOLD, tongue spatulas	118
chest	132	TOENNIS, dissecting scissors	417
Surgical scissors	407-411, 418	dura retractors	294
DUROTIP	381, 382	dura knives	98
Suture forceps, DUROGRIP	441	DUROGRIP needle holder	509
Suture forks	142	TOENNIS MODIF., DUROGRIP needle holder	509
Suture guide, laryngeal micro	158	TOENNIS-ADSON, delicate dissecting scissors	416, 417
Suture tying forceps	177, 178	DUROTIP dissecting scissors	384, 387
micro	177, 178	NOIR dissecting scissors	377
Swivel knives	96	Tongue depressors	116
SYME, raspatories	205	Tongue forceps	117, 497
tonsil dissector	137	Tongue retractor, ERGOPLANT	118
Syndesmotomes	202	Tongue spatulas	116-118, 123, 125-131, 522
Syringes	543-545	Tonsil dissectors	136, 137, 541
		Tonsil forceps	134, 135, 138, 483
		Tonsil knives	138
		Tonsil punches	143
		Tonsil scissors	139

Alphabetical Index

T – W

	Page		Page
Tonsil snares	140, 142	V	
Tonsillotom handle	143	VANNAS , micro scissors	168, 170, 171
Tonsillotomes	143	Vascular forceps	454
Towel clamps	351-354	Vascular scissors	414, 423
TOYNBEE , ear speculas	3	Vein hooks	291
Tracheal dilators	274	Vein retractors	309-311
Tracheal retractors	298-300	VERHOEVEN , suction cannulas	44, 529
Transplant carriers	36	Vessel clamp, ATRAUMATA TITANIUM	468, 469
Trays, preparation	39	Vessel clips	192, 196, 198, 458
storage, MINOP TREND	63	non-traumatic	458
TRELAT , raspatories	209	Vessel dilators, micro	179
TREND , curettes	86-88	Vessel hooks	12, 290-293
dissectors	87, 88	VIDAL , lupus spatula	98
enucleators	86, 88	WISE , micro suture tying forceps	177
hook	87, 88	VOLKMANN , bone curettes	221
Trocars, antrum	79	bone retractors	322, 323
sinuscopy	80	retractors	322, 324
universal	80		
TROELTSCH , dissecting forceps, angular	444	W	
TROUSSEAU , tracheal dilators	274	WAGENER , ear hooks	12
Tube catheter	8	WALSHAM , septum forceps	110
Tubes, dissecting, suction	104, 541	WALTER , chisels	108
irrigation/suction, MINOP TREND	63	gouges	231
nasal suction	537	osteotomes	107
spare silicon	119	retractors	103
suction	528	WANGENSTEEN , DUROGRIP dissecting forceps	441
suction, dissecting	104, 541	WARD , raspatories	209
suction, nasal	537	WATSON-CHEYNE , raspatories	100
Tubing clamps	349, 350	WATSON-WILLIAMS , rongeurs	76
Tubing forceps	342, 478	WAUGH , delicate tissue forceps	449
Tubular shaft forceps	153	Wavecut scissors	375, 377-379, 386-390
TUDICHUM , nasal speculas	50	WEBER , ear loops	10
TUFFIER , organ and tissue grasping forceps	492	WEBSTER , DUROGRIP needle holder	501
TUMARKIN , ear speculas	4	WECKER , eye scissors	169
Tumor forceps	454	WEDER , tongue spatulas	117
Tumor grasping forceps	85	WEERDA , cartilage forceps	153
Tuning forks	7	WEIL-BLAKESLEY , rongeurs	72
Twisters, wire, DUROGRIP	266	WEITLANER , self-retaining retractors	277-279
TYDING , tonsil snares	142	WEST , nasal tampon forceps	92
		WHITE , tonsil forceps	134
U		WHITEHEAD , mouth gags	122
UFFENORDE , bone curettes	220	WHITEHEAD-JENNINGS , mouth gags	122
ULRICH-AESULAP , sponge and dressing forceps	345	WIENER MODELL , nasal speculas	53, 54
Ultra light forceps, ATRAUMATA	436	WIKSTROEM , dissecting and ligature forceps	488
UNITRAC , arm, sterile drape	61	WILDE , dissecting forceps, angular	444
CO ₂ air cartridge	60	nasal polypus snares	112
CO ₂ air cartridge adapter	60	WILDER , dilators for lacrymal duct	521
couplings	61	WILLIGER , bone curettes	221
holding arm	60	elevators	200
Universal trocars	80	raspatories	209
US-ARMY , retractors	321	retractors	306
		bone curettes	216

Alphabetical Index

W – Z

	Page	Page
WILSON , hemostatic forceps	483	
tonsil forceps	483	
Wire bending forceps	23	
Wire bending pliers	267	
Wire cutters	270, 271	
Wire cutting pliers	271	
lateral cutting action	271	
Wire cutting scissors	268, 269	
DUROTIP	268	
Wire holding forceps, DUROGRIP	266	
Wire loops	13, 112, 141	
Wire scissors	268	
Wire twisters, DUROGRIP	266	
Wires, snare	141	
WULLSTEIN , micro needle	25	
raspatories	38	
self-retaining retractors	278	
Y		
YANKAUER , suction cannulas	539	
YASARGIL , arachnoid blades	369	
clamping arm	6	
micro forceps	83	
micro scissors	171	
rongeurs	85	
YOUNG , tongue forceps	117	
Z		
ZAUFAL , ear levers	10	
ZAUFAL-JANSEN , bone rongeurs	247	
ZENKER , retractors	337	
ZOELLNER , ear speculas	5	
suction cannulas	43, 44, 529	

Alphabetischer Index

A – B

	Seite		Seite
A			
Abnehmezangen, Bulldogklemmen	459	Approximatoren, Nerv-	195
ABRAHAM , Tonsillenfasszangen	135	Arterienklemmen	342, 478-483, 496
Tonsillennmesser	138	Feine-	470-477
ACLAND , Approximatoren	196	Arteriotomiescheren	416
Clip-Anlegepinzetten	197	ASH , Septumrichtzangen	110
Gefäßclips	196	ATRAUMATA , Bulldogklemmen	461-463
Adapter, Kaltlichtkabel-	58	Coarctationsklemmen	466
Kartuschen-, UNITRAC	60	Gefäßklemmen TITANIUM	468, 469
MINOP TRREND	63	Gewebefasszangen	495
Saug-	44	Klemmen	464, 466, 467
Adenotome	147	Ligaturklemmen	465
Adenotomklingen	147	Organfasszangen	495
ADLERKREUTZ , Chirurgische Pinzetten	454	Patent-Ductusklemmen	467
ADSON , Arterienklemmen	475, 476	Peripheralklemmen	467
Chirurgische Pinzetten	447	Pinzetten	438, 439
DUROGRIP atraumatische Pinzetten	440	Pinzetten TITANIUM	437
Feine anatomische Pinzetten	429	Pinzetten, Mikro-	180
Feine chirurgische Pinzetten	445, 446	Präparierklemmen	465
Nerv- und Gefäßhäkchen	292	Atraumatische Gefäßclips	458
Pinzetten, bajonettförmig	442	Atraumatische Pinzetten, DUROGRIP	440
Raspatorien	208, 212	ERGOPLANT	180, 428, 436
Saugkanülen	531	Ultra-Light	436
TITANIUM Feine anatomische Pinzetten	428	AUFRICHT , Knochenraspeln	240
ADSON-BABY , Wundspreizer	282	Nasenretractor	103
ADSON-BROWN , Chirurgische Pinzetten	447	Aufrichter, Nasenfraktur-	111
AESCULAP , Korn- und Tupferzangen	345	Augenpinzetten	445
Waschzangen	345	Augenscheren	169
Ahle, Knochen-	239	Augensonden	521
Ahlen	239	AUSTIN , Mikro-Knüpfpinzetten	177
ALEXANDER , Hohlmeißel	227		
Hohlmeißelzangen	246	B	
ALLENBERG , Carotissperrer	279	BABCOCK , Organ- und Gewebefasszange	494, 495
ALLIS , Atraumatische Organ- und Gewebefasszangen	495	BABY-ADSON , Präparier- und Ligaturklemmen	485
Organ- und Gewebefasszangen	493	BABY-ALLIS , Organ- und Gewebefasszangen	492
ALLIS-ADAIR , Organ- und Gewebefasszangen	492	BABY-CRILE (KOCHER) , Arterienklemmen	472
ALLIS-THOMS , Organ- und Gewebefasszange	494	BABY-CRILE (PEAN) , Arterienklemmen	472
ALLPORT , Wundspreizer	276	BABY-CRILE-WOOD , DUROGRIP Nadelhalter	502
Anatomische Mikro-Pinzetten, Dia Dust	180	BABY-METZENBAUM , DUROTIP Präparierscheren	384, 387
Anatomische Pinzetten	434, 435	NOIR Feine Präparierscheren	376
Feine-	429-433	Präparierscheren	422
ANGLE , Drahtschneidezangen	270	Supercut Präparierscheren	395
Anlegepinzetten, Clips	197	BABY-MIKULICZ , Peritoneumklemmen	491
Anlegezangen, Bulldogklemmen	459	BABY-MIXTER , Präparier- und Ligaturklemmen	484
Clips	198	BABY-MOSQUITO (HARTMANN) , Arterienklemmen	470
Antrumhäkchen	30	BABY-OVERHOLT , Präparier- und Ligaturklemmen	484
Antrumhaken	78, 331	BABY-ROUX , Wundhaken	314
Antrumküretten	78	BABY-SENN-MILLER , Wundhaken	312
Antrumlöffel	77	BACKHAUS , Tuchklemmen	351
Antrumstanzen	66, 67	BACKHAUS-KOCHER , Tuchklemmen	351
Antrumtrephine	79	Bajonettförmige Pinzetten	111, 442, 443
Antrumtrokare	79	DUROGRIP	441
Applikationsinstrumente	31	BALLENGER , Schwingmesser	96
Approximatoren	195, 196	Septum-Hohlmeißel	105
Mikro-	194		

	Seite		Seite
BANE-HARTMANN , Hohlmeißelzangen	245	Bruststütze	132, 151
BARNHILL , Ringmesser	145	BRYANT , Korn- und Tupferzangen	343
BARRAQUER , Mikro-Nadelhalter	181	BÜCHS , Raspatorien	212
BARRON , Saugkanülen	537	Wundhaken	335
Skalpellgriff	363	BUCHWALD , Zungenspatel	116
BARTH , Scharfe Löffel	216	BUCK , Fremdkörperinstrumente	13
BAUMGARTNER , DUROGRIP Drahtspannzangen	266	Ohrküretten	11
DUROGRIP Nadelhalter	266, 502	Watteträger	523
BEALES , Raspatorien	38	Bulldogklemmen	459, 460
BECKMANN , Nasenspekula	52	Atraumatische-	461-463
Ringmesser	144	Bulldogscheren	412
BEEBE , Blech- und Drahtscheren	269		
BELLUCCI , Mikro-Schere	14		
Saugkanülenset	528		
BERGMANN , Wund- und Trachealhäkchen	298	C	
BERNHARD , Tuchklemmen	351	CAIRNS , Arterienklemmen	473
BEYER , Hohlmeißelzangen	246, 247	Durahäkchen	294
BIEMER , Anlegepinzetten für Gefäßclips	193, 194	Knochendeckelelevatorien	200
Gefäßclips	192	CAIRNS-DOTT , Feine anatomische Pinzetten	432
Mikro-Approximatoren	194	CANNY-RYALL , Wundhaken	321
Mikro-Venenscheren	170	Carotissperrer	279
Nerv-Approximator	195	CARREL , Arterienklemmen	470
BIEMER-MÜLLER , Mikro-Approximatoren	194	CASPAR , Explorationshäkchen	293
BILEAU , Ohrschlingen	10	Raspatorien	211
BIRKETT , Arterienklemmen	477	Skalpellgriff	368
BISHOP-HARMON , Augenpinzetten	445	Stößel	238
Feine chirurgische Pinzetten	445	Wundhaken	336
BLAKESLEY-WILDE , Nasenzangen	73	CASTROVIEJO , Augenpinzetten	445
Blechscheren	268, 269	Augenscheren	169
DUROTIP	268	DUROGRIP Nadelhalter	190, 191
BLOHMKE , Tonsillenfasszangen	135	Feine chirurgische Pinzetten	445
BLUMENTHAL , Hohlmeißelzangen	245	Hautmesszirkel	96
BOETTCHER , Tonsillenscheren	139	Mikro-Federscheren	168
BÖHLER , Hohlmeißelzangen	247	Mikro-Nadelhalter	183
Knochensplitterzangen	250	CAWTHORNE , Fasszängchen	18
BOIES , Nasenfrakturaufrichter	111	Mikro-Schere	15
BONNER MODELL , Mikro-Knüpfpinzetten	177	Ohrhebel	12
BONNEY , Anatomische Pinzetten	435	Ohrsonde	521
BOSE , Wund- und Trachealhäkchen	298	CHADWICK , Feine Scheren	403
Wundspreizer	275	CHAPUT , Organ- und Gewebefasszangen	492
BOUCHERON , Ohrspekula	2	Chirurgische Mikro-Pinzetten, Dia Dust	180
BOWMAN , Augensonden	521	Chirurgische Pinzetten	447, 450-454
BOYS-ALLIS , Organ- und Gewebefasszangen	492	ERGOPLANT	428
BRASKY , Hauthäkchen	297	Feine-	445-449
BRAUN , Organ- und Gewebefasszangen	133	Chirurgische Scheren	407-411, 418
Brillen, Nystagmus	6	DUROTIP	381, 386
BRODIE , Hohlsonden	518	CHOMPRET , Syndesmotome	202
BROM , Venenhäkchen	291	CINELLI , Osteotome	105
BROPHY , Chirurgische Pinzetten	450	CITELLI , Löffelzängchen	22
Feine anatomische Pinzetten	432	Stanzen	255
BROWN , Chirurgische Pinzetten	447	CITELLI-BEYER , Stanzen	255
BRÜNINGS , Septumzangen	71	Clip-Anlegepinzetten	193, 194, 197
Tonsillenschnürer	140	Clip-Anlegezangen	198
Zungenspatel	116	Clips, Atraumatische Gefäß-	458
BRÜNINGS-BRUNK , Antrumhaken	78, 331	Gefäß-	192, 196, 198, 458
BRUNS , Scharfe Löffel	220		

Alphabetischer Index

C – D

	Seite		Seite
Clips, Gefäß-, atraumatische	458	D	
CO ₂ Druckluftkartusche	60	DANDY , Arterienklemmen	471
CO ₂ Kartuschenadapter, UNITRAC	60	DAUBENSPECK , Scharfe Löffel	222
COAKLEY , Antrumküretten	78	DAUTREY , Osteotome	227
Coarctationsklemmen, Atraumatische-	466	DAVIES-BOYLE , Mundsperrerr Zungenspatel	124 129
COLLER , Feine Arterienklemmen	474	DAVIES-MEYER , Mundsperrerr	123
COLLIN , Atraumatische Organ- und Gewebefasszangen	495	DE BAKEY , Arteriotomiescheren	416
Organ- und Gewebefasszangen	496, 497	Atraumatische Bulldogklemmen	462
Tupfer- und Schwammzangen	497	Atraumatische Coarctationsklemmen	466
Wundhaken	316	Atraumatische Klemmen	466, 467
Zungenzangen	117, 497	Atraumatische Patent-Ductusklemmen	467
COLLIN-HARTMANN , Wundhaken	313	Atraumatische Peripheralklemmen	467
Collumela Klemme	111	Atraumatische Pinzetten	438, 439
COLVER , Tonsillenfasszangen	134	Atraumatische Präparier- und Ligaturklemmen	465
Conchotome	70	Atraumatische Ultra-Light-Pinzetten	436
CONVERSE , DUROGRIP Nadelhalter	501	DUROGRIP Nadelhalter	505
Plastikmesser	98	Saugkanülen	538, 539
COOLEY , Atraumatische Klemmen	464	TITANIUM Atraumatische Gefäßklemmen	468, 469
Atraumatische Pinzetten	439	TITANIUM Atraumatische Pinzetten	437
Feine anatomische Pinzetten	433	Wundspreizer	285
Gefäßscheren	423	DE BAKEY-HESS , Bulldogklemmen	460
COOPER , Chirurgische Scheren	409	DEAN , Tonsillenscheren	139
COTTLE , Bulldog-Scheren	412	DEAVER , Chirurgische Scheren	411
Elevatorien	99, 101	DENIS-BROWNE , Tonsillenfasszangen	135
Fischschwanzosteotom	106	DERF , DUROGRIP Nadelhalter	500
Fixierpinzetten	111	Dermatome, Hand-	113
Hämmer	235	DERRA , Atraumatische Klemmen	464
Hauthäkchen	295	DESCHAMPS , Unterbindungsnadeln	511-513
Nasenflügelretractor	102	DESMARRES , Wund- und Venenhaken	309
Nasenscheren	91	Dia Dust , Anatomische Mikro-Pinzetten	180
Nasenspekula	56	Chirurgische Mikro-Pinzetten	180
Osteotome	106	Mikro-Nadelhalter	185-189, 508
Raspatorien	99, 101, 211	Mikro-Nadelhalter, TITANIUM	166, 167
Septummesser	98	Mikro-Pinzetten, Anatomische	180
Septumrichtzangen	110	Mikro-Pinzetten, Chirurgische	180
Septumspekula	57	Nadelhalter, Mikro-	185-189, 508
Wund- und Venenhaken	309	Nadelhalter, Mikro-, TITANIUM	166, 167
COTTLE-KNAPP , Feine Präparierscheren	413	Diamant Raspel	240
COTTLE-MASING , Feine Präparierscheren	413	Diamant-Messer	371
CRAIG , Septumzangen	95	DIEFFENBACH , Bulldogklemmen	459
CRAIG-DOMNICK , Septumzangen	95	DIETER , Hammerkopfstanzanzen	23
CRILE , Arterienklemmen	472, 474	DIETHRICH , Bulldogklemmen	460
Nerv- und Gefäßhäkchen	291	Dilatatoren, Mikro-Gefäß-	179
Wundhaken	315	Stirnhöhlen-	80
CRILE-WOOD , DUROGRIP Nadelhalter	502	Tracheal-	274
Cruratomieschere, Mikro-	15	Tränenkanal-	521
CUSHING , Chirurgische Pinzetten	450	DINGMANN , Knochenhalte-zangen	253
DUROGRIP Pinzetten	441	Mundsperrerr	122
Feine anatomische Pinzetten	432	DINGMANN MODIF. , Knochenhalte-zangen	253
Nerv- und Gefäßhäkchen	291, 293	Dissektoren, Mikro-	37
Wund- und Venenhaken	311	Saug-	104
CUSHING-KOCHER , Wund- und Venenhaken	310	Tonsillen-	136, 137, 541
CUSHING-LANDOLT , Hypophysenspekula	81	TREND	87, 88
CZERNY , Organ- und Gewebefasszangen	133	DIXON-LOVELACE , Arterienklemmen	475
Wundhaken	320		

Alphabetischer Index

D – F

	Seite		Seite
DOCKHAM , Wundhaken	336	EAST GRINSTEAD (WARD) , Osteotome	230
Doppelinstrument, Stirnhöhlen-	80	EICKEN , Spülröhrchen	79
Doppelknopfsonden	520	Einlage, Silikon-	123
DOUGHTY , Zungenspatel	130	Einmalskalpelle	360-362
DOYEN , Hohlsonden	518	Sicherheits-	358, 359
Raspatorien	215	Elevatorien	99-102, 200-203
Rippenraspatorien	215	Knochendeckel-	200
DOYEN-COLLIN , Mundsperrler	119	Stapes	36
DOYEN-JANSEN , Mundsperrler	119	EMMET , Fistelhaken	307
DRAFFIN , Mundsperrlerhalter	132	Endoskope	64
Draht- und Blechscheren	268, 269	E nukleationsscheren	413
DURROTIP	268	E nukleatoren, TREND	86, 88
Drahtbiegezangen	23, 267	ERGOPLANT , Atraumatische Pinzetten	428
Drähte, Schnür-	141	Chirurgische Pinzetten	428
Drahtfasszangen, DUROGRIP	266	Hämmer	236
Drahtscheren	268, 269	Hohlmeißelzangen	244
DURROTIP	268	Klingenhalter	368
Drahtschlingen	13, 112, 141	Knochenfeilen	241
Drahtschneidezangen	270, 271	Knochensplitterzange	248
DURROTIP	270	Mikro-Knochenmühlen	109
Drahtspannzangen, DUROGRIP	266	Mundkeile, Silikon-	120
Drücker, Zungen-	116	Pinzetten für Weichgewebe	428
Druckkartusche, CO ₂ , UNITRAC	60	Pinzetten, Atraumatische	428
Ductusklemmen, Atraumatische-	467	Pinzetten, Chirurgische	428
DUNHILL , Arterienklemmen	472, 477	Raspatorien	204
DUPLAY , Korn- und Tupferzangen	344	Reiniger für Knochenmühle	109
Durahäkchen	294, 297	Scharfe Löffel	218
DURHAM , Wundhaken	333	Schneideplatten	109
DUROGRIP , Drahtfasszangen	266	Silikonmundkeile	120
Drahtspannzangen	266	Zungenretraktoren	118
Fasszangen, Draht-	266	Ersatzbacken, Hämmer	235-237
Knochenraspeln	99, 242	Ersatzklingen, Dermatome	113
Mikro-Nadelhalter	190, 191	Ersatzlampen	6
Nadelhalter	266, 500-510	Ersatznadeln, Nerv-Approximator	195
Nadelhalter mit Schere	504	Ersatz-Silikonschläuche	119
Nadelhalter, Mikro-	190, 191	EVES , Tonsillenschnürer	140
Nahtpinzetten	441	Tonsillenschnürer SUSI	140
Pinzetten	440, 441	Explorationshäkchen	293
DURROTIP , Blechscheren	268		
Chirurgische Scheren	381, 386	F	
Drahtscheren	268	Fadengabeln	142
Drahtschneidezangen	270	Mikro-	158
Fadenscheren	380, 386	Fadenklemmen	458
Feine Scheren	380	Fadenmesser, Carbon Steel	367
Ligaturscheren	390	Stainless Steel	367
Präparierscheren	382-385	Fadenpinzetten	435
Scheren	268	Fadenscheren, DURROTIP	380, 386
Scheren mit Wellenschliff	386-390	Feine-, NOIR	375
Duschen, Luft-	8	Mikro-	173
DUVAL-COLLIN , Organ- und Gewebefasszangen	496	FAHLBUSCH , Mikro-Schere	83
		FARABEUF , Raspatorien	213
E		Wundhaken	315
EAST GRINSTEAD (WARD) , Flachmeißel	230	FARABEUF-COLLIN , Raspatorien	213

Alphabetischer Index

F – G

	Seite		Seite
FARRELL , Watteträger	522, 524	FOWLER , Tonsillennmesser	138
Fasszängchen	16–20, 84	FRAENKEL , Kehlkopfpolypezange	160
Mikro-Larynx-	153, 156	Kehlkopfzange	161
Fasszangen	68	FRANKFURT , Wundspreizer	289
Atraumatische Gewebe-	495	FRASER-KELLY (CRILE) , Arterienklemmen	476
Atraumatische Organ-	495	FRAZIER , Durahäkchen	294
Draht-, DUROGRIP	266	Saugkanülen	535, 536
Gewebe-	133, 492–497	FREER , Elevatorien	100, 202
Gewebe-, Atraumatische	495	Flachmeißel	223
Kieferhöhlen-	69	Hauthäkchen	295
Knorpel-	153	Hohlmeißel	223
Organ-	133, 492–497	Raspatorien	100–202
Organ-, Atraumatische	495	Mukosamesser	96
Rippen-	253	FREER-YASARGIL , Raspatorien	100
Tonsillen-	134, 135, 138	Fremdkörperinstrumente	13
Tumor-	85	FRENZEL , Nystagmusbrillen	6
FEILCHENFELD , Splitterpinzetten	455	Zungenspatel	116
Feilen, Knochen-	240	FRIEDMANN , Hohlmeißelzangen	243
Knochen-, ERGOPLANT	241	FUCHSIG , Arterienklemmen	475
rund	234	Führungsgabeln	31
Feine anatomische Pinzetten	429–433	Führungs-Hohlsonden	514, 515
Feine Arterienklemmen	470–477	Führungsnadeln	525
Feine chirurgische Pinzetten	445–449	Furunkelmesser	9
Feine Fadenscheren, NOIR-	375	Fußplattenhäkchen, Mikro-	29
Feine Nasenzangen	73		
Feine Präparierscheren	398, 399, 406, 412–417		
NOIR	375–379		
Feine Scheren	397–406, 412	G	
DUROTIP	380	Gabelhaken, Treangle-Griff	301
Supercut	392	Gabeln, Faden-	142, 158
FERGUSSON , Knochenhalte­zangen	252	Führungs-	31
Saugkanülen	532, 535	Mikro-	158
FERGUSSON-ACKLAND , Mundsperrerr	121	GALLAHER , Knochenfeilen	240
FERRIS-SMITH , DUROGRIP Pinzetten	441	GAST , Zungenspatel	127
FICKLING , Arterienklemmen	482	Gaumenplatte	123
FINSEN , Wundspreizer	275	Gefäßclipps	192, 196, 198, 458
FINSEN MODIF. , Wundspreizer	275	Atraumatische-	458
FISCH , Dura- und Hauthäkchen	297	Gefäßdilatoren, Mikro-	179
Fischschwanzosteotom	106	Gefäßhäkchen	12, 290–293
FISHER , Tonsillennmesser	138	Gefäßklemmen, Atraumatische TITANIUM	468, 469
Fistelhaken	307	Gefäßpinzetten	454
Fixierklemmen	352	Gefäßscheren	399, 414, 423
Fixierpinzetten	111	GELPI , Hautspreizer	285
Fixiervorrichtung	6	GEMINI , Präparier- und Ligaturklemmen	487
Flachmeißel	42, 108, 223, 225–227, 230, 232	GERALD , Feine anatomische Pinzetten	431
Flachzangen	267	Feine chirurgische Pinzetten	449
Flexible Verbindungsklemme	60	TITANIUM Feine anatomische Pinzetten	431
FOERSTER-BALLENGER , Tupfer- und Schwammzangen	348	TITANIUM Feine chirurgische Pinzetten	431
FOMON , Knochenraspeln	241	Gewebefasszangen	133, 492–497
Nasenflügelretraktor	102	Atraumatische-	495
Nasenflügelscheren	413	Gewebekralle	297
Nasenscheren	91	GIERTZ-STILLE , Rippenscheren	251
Osteotome	105	GILLIES , DUROGRIP Nadelhalter mit Schere	504
Supercut Scheren	393	Feine anatomische Pinzetten	431
FORMBY , Saugkanülen	536	Feine chirurgische Pinzetten	449
Zerumenlöffel	8		

Alphabetischer Index

G – H

	Seite		Seite
GILLIES , Hauthäkchen	296	Häkchen, Haut-	294-297
Osteotome	225	Mikro-	27-30, 158
Saugkanülen	531	Nerv-	12, 290-293
Giraffenzangen	68	Ohr-	12
GLATZEL , Nasenspiegel	96	Tracheal-	298-300
Glomus-Spreizer	286	TREND	87, 88
GLOVER , Atraumatische Bulldogklemmen	462	Venen-	291
GLUCK , Rippenscheren	251	Wund-	294-300
GOELET , Wundhaken	321	Haken, Antrum-	78, 331
GOLDMAN-FOX , DUROTIP Feine Scheren	380	Gabel-	301
Supercut Scheren	393	Knochen-	322, 323
GOLDMANN , Nasenfrakturaufrichter	111	Nasen-	103
GOOD , Tonsillenscheren	139	Parotis-	308
GORNEY , Feine Präparierscheren	417	Sattel-	304
Saugdissektor	104	Schilddrüsen-	311
Supercut Präparierscheren	396	Sehnenscheiden-	308, 309
GOSLEE , Flachzangen	267	Venen-	309-311
GRAEFE , Chirurgische Pinzetten	447	Wund-	103, 296, 301-337
Feine Präparierscheren	412	HALLE , Elevatorien	202
Haut- und Wundhäkchen	294	Raspatorien	202
Nerv- und Gefäßhäkchen	290	Scharfe Löffel	222
GREENE , Wundhaken	334	HALSEY , DUROGRIP Nadelhalter	500, 501
GREGORY Atraumatische Bulldogklemmen	463	HALSTED , Arterienklemmen	475
GREY-TURNER , Arterienklemmen	477	HALSTED-MOSQUITO , Arterienklemmen	470, 476
Griffe, Hand-	42, 159	Haltearm	62
Saug-	43	UNITRAC	60
Skalpell-	363-365	Haltekloben	62
Skalpell-, Mikrochirurgische Klängen	368, 369	Halter, Laryngoskop-	151
Spiegel-	150	Mundsperrer	132
Spül-, Saug-, MINOP TREND	63	Ohrspekula-	6
Tonsillotom-	143	Haltezangen, Knochen-	252, 253
GROSS , Korn- und Tupferzangen	344	Hämmer	42, 235-237
GRUBER , Ohrspekula	3	ERGOPLANT	236
GRUENWALD , DUROGRIP Pinzetten, bajonettförmig	441	Ersatzbacken	235-237
Pinzetten, bajonettförmig	443	Hammerkopfstanzen	23
GRUENWALD-HENKE , Conchotome	70	Handdermatome	113
GUILFORD-WRIGHT , Drahtscheren	268	Handgriffe	42
GUTHRIE , Haut- und Wundhäkchen	294	Saug-	43
Hauthäkchen	294	Stabinstrumente	159
GWYNNE-EVANS , Tonsillendissektoren	137	HARDY , TREND Eukleatoren	86, 88
		TREND Küretten	86-88
		HARTMANN , Conchotome	70
		Fasszängchen	18
		Löffelzängchen	21, 22
		Nasenspekula	51, 53, 54
		Nasentamponzangen	93
		Ohrspekula	2-5
		Ohrtamponzangen	24
		Stimmgabeln	7
		Tonsillenstanzen	143
		Tubenkatheter	8
		Zungenspatel	118
		HARTMANN-HALLE , Nasenspekula	51
		HARTMANN-WULLSTEIN , Fasszängchen	18
		Löffelzängchen	21
		HARVEY , Blech- und Drahtscheren	268
H			
HAASE , Repositionszangen	254		
HAJEK , Hämmer	237		
Osteotome	320		
Spülkanülen	80		
HAJEK-KOFLER , Stanzen	256, 257		
HAKANSSON , Hohlmeißelzangen	245		
Häkchen, Antrum-	30		
Dura-	294, 297		
Explorations-	293		
Fußplatten-	29		
Gefäß-	12, 290-293		

Alphabetischer Index

H – K

	Seite		Seite
Hauthäkchen	294-297	I	
Hautkralle	297	Implantat-Presszangen	39
Hautmesszirkel	96, 356	Instrumente für die festsitzende Technik	267
Hautspreizer	285	Instrumente, Fremdkörper-	13
Hautstanzen	113	Ligatur-	142
Hebel, Ohr-	10, 12	Mess-	39
HEERMANN , Flachmeißel	42	Inzisions-Scheren	411
Hämmer	42	Irisscheren	397, 400
Handgriffe	42		
Hohlmeißel	42	J	
HEGAR-MAYO , DUROGRIP Nadelhalter	503	JACOBSON , Arterienklemmen	471, 476
HEGAR-MAYO-SEELEY , DUROGRIP Nadelhalter	503	Mikro-Federscheren	171
HEGAR-OLSEN , DUROGRIP Nadelhalter mit Schere	504	Mikro-Nadelhalter	183
HEGAR-OLSEN MODIF. LANGE , DUROGRIP Nadelhalter mit Schere	504	Scharfe Löffel	216
HEISS , Arterienklemmen	477	JÄGER , Hauthäkchen	296
Präparier- und Ligaturklemmen	477	JAMESON , Feine Präparierscheren	415
HEISTER , Mundsperrer	119	Supercut Scheren	393
HEMINGWAY , Scharfe Löffel	218, 219	JAMESON-WERBER , Feine Präparierscheren	415
HENCKEL-TILLEY , Rongeurs	74	JANSEN , Hohlmeißelzangen	245, 246
HENKE , Tonsillendissektoren	136	Pinzetten, bajonettförmig	442
HENKEL , Löffelzängchen	24	Raspatorien	210, 211
HEYMANN , Nasenscheren	90	Scharfe Löffel	216, 218
HEYMANN-KNIGHT , Nasenscheren	90	Wundspreizer	276
Septumzangen	95	JANSEN-MIDDLETON , Nasenzangen	94
HEYWOOD-SMITH , Organ- und Gewebefasszangen	497	JATHO , Nasenrachenzangen	148
Tupfer- und Schwammzangen	497	JEFFERSON , Feine anatomische Pinzetten	429
Zungenzangen	497	Feine chirurgische Pinzetten	446
HEYWOOD-SMITH MODIF. , Organ- und Gewebefasszangen	497	Wundspreizer	284
Tuper- und Schwammzangen	497	JOBSON-HORNE , Ohrsonden	8
Zungenzangen	497	JOHNS-HOPKINS , Anlege- und Abnehmzangen	459
HILL , Raspatorien	101	Bulldogklemmen	459
Hohlmeißel	42, 108, 223, 225-227, 231-233	JOLL (FRIEDMAN) , Thyreoid-Spreizer	287
Septum-	105, 107	JOSEPH , Feine Scheren	397, 406
Hohlmeißelzangen	243-247	Haut- und Wundhäkchen	296
ERGOPLANT	244	Hauthäkchen	296
Hohlsonden	518	Irisscheren	397
Führungs-	514, 515	Knochenfeilen	240
Hornhautpinzetten	429	Nasensägen	99
HÖSEL , DUROGRIP Nadelhalter	510	Plastikmesser	97, 98
HOUGH , Fasszängchen	18	Plastikscheren	406
HOUSE , Saug- und Spülkanülen	542	Raspatorien	209
Saugadapter	44	Supercut Präparierscheren	394
Scharfe Löffel	40, 41	JUDD-ALLIS , Organ- und Gewebefasszange	494
HOWARD , Raspatorien	101	JURASZ , Kehlkopfpolypenzange	160
HUDSON , Chirurgische Pinzetten	447	Nasenrachenzangen	148
Feine anatomische Pinzetten	429		
HUGHES , Stapesmobilisatoren	31	K	
HUNTER , Splitterpinzetten	455	Kabel, Kaltlicht-	58, 152
HURD , Tonsillendissektoren	136	Kaltlichtkabel	58, 152
Unterbindungsnadeln	513		
Hypophysenspekula	81, 82		

	Seite		Seite
Kaltlichtkabel-Adapter	58	Klemmen, Peripheral-, Atraumatische	467
KANTROWITZ , Präparier- und Ligaturklemmen	489	Peritoneum-	491
Kanülen	543	Präparier-	475, 477, 484-490
Saug-	43, 44, 529-543	Präparier-, Atraumatische	465
Spül-	80, 542	Schlauch-	342, 349, 350, 478
Kanülenköpfe	544, 545	Sinus-	343
Kartuschenadapter, CO ₂ , UNITRAC	60	Tonsillen-	483
Katheter, Tuben-	8	Tuch-	351-354
Kathetereinführungszangen	355	Klingen, Adenotom	147
KAYE , Supercut Präparierscheren	396	Mikrochirurgische-	369
KAZANJIAN , Knochensplitterzangen	248	Skalpell-, Carbon Steel	366, 367
Kehlkopfnadelhalter	157	Skalpell-, Stainless Steel	366, 367
Kehlkopfpolypenzangen	160	Klingenhalter, ERGOPLANT	368
Kehlkopfspiegel	150	KLINIKUM BERLIN , Schlauchklemmen	349
Kehlkopfzangen	161	Kniegebogene Pinzetten	444
KELLY , Arterienklemmen	471	Knochen- und Knorpelquetschen	109
Feine Scheren	406	Knochenahlen	239
KERRISON , Stanzen	255, 260-265	Knochendeckelelevatoren	200
Kette	120	Knochenfeilen	240
KEYES MODIF. , Hautstanzen	113	ERGOPLANT	241
Kieferhöhlen-Fasszangen	69	Knochenfixierzange	252
KILLIAN , Elevatoren	100	Knochenhaken	322, 323
Laryngofissurschere	161	Knochenhalte-zangen	252, 253
Nasensonde	521	Knochenmühle, Mikro, ERGOPLANT	109
Nasenspekula	55, 56	Reiniger, Ergoplant	109
Septum-Hohlmeißel	107	Knochenraspeln	240, 241
KILLIAN-CLAUS , Septum-Hohlmeißel	107	DUROGRIP	99, 242
KILNER , DUROGRIP Nadelhalter	502	Knochenscheren	249
Feine Präparierscheren	412, 415	Knochensplitterzangen	248-250
Hauthäkchen	295	ERGOPLANT	248
Wundhäkchen	297	Knochenstanzen	255-257, 261-265, 282
Wundhaken	312, 318	NOIR	260, 261
KINGS'S COLLEGE HOSPITAL , Watteträger	523	Knopfsonden	520, 521
KIRSCH , Wundhaken	333	Doppel-	520
KIRSTEIN , Nasenscheren	90	Sinus-	520
KLAPP , Sehnenscheidenhaken	308	Knorpel- und Knochenquetschen	109
Kleiderscheren	425, 426	Knorpelfasszangen	153
KLEINERT-KUTZ , Hauthäkchen	295	Knorpelritzmesser	97
Klemmen, Arterien-	342, 478-483, 496	Knorpelritz-zangen	111
Arterien-, Feine	470-477	Knorpelscheren	417
Atraumatische-	464-467	Knüpppinzetten, Mikro-	177, 178
Atraumatische Bulldog-	461-463	KOCHER , Arterienklemmen	480
Atraumatische Coarctations-	466	Führungs-Hohlsonden	515
Atraumatische Ligatur-	465	Knochen- und Wundhaken	322
Atraumatische Patent-Ductus-	467	Wund- und Venenhaken	310
Atraumatische Peripheral-	467	Wundhaken	331, 337
Atraumatische Präparier-	465	KOCHER-LANGENBECK , Wundhaken	327
Bulldog-	459, 460	KOCHER-OCHSNER , Arterienklemmen	481
Bulldog-, Atraumatische	461-463	KOFLER , Stanzen	257
Coarctations-, Atraumatische	466	KÖNIG , Elevatoren	200
Collumela	111	Führungs-Hohlsonden	514
Faden-	458	Raspatorien	208
Fixier-	352	Wund- und Venenhaken	310
Ligatur-	475, 477, 484-489, 490	Konisationsmesser	366
Ligatur-, Atraumatische	465	Kornzangen	342-347
Patent-Ductus, Atraumatische	467	KRÄMER , Raspatorien	214

Alphabetischer Index

K – L

	Seite		Seite
KRÄMER, Wundhaken	335	LATHEBURY-FARRELL, Watteträger	522-524
KRAUSE, Nasenpolypenschnürer	112	LAZAR, Mikro-Knüpppinzetten	177
Ohrpolypenschnürer	13	LELAND-JONES, Atraumatische Klemmen	467
KRAUSE-VOSS, Nasenpolypenschnürer	112	LEMPERT, Hohlmeißelzangen	246
KRAYENBÜHL, Nerv- und Gefäßhäkchen	292	Raspatorien	38, 208
KRONECKER, Unterbindungsnadeln	511	Saugkanülen	536
KRÖNLEIN, Arterienklemmen	342	Scharfe Löffel	221
Küretten, Antrum-	78	LERICHE, Arterienklemmen	473
Ohr-	11	LEWIS, Knochenraspeln	240
TREND-	86-88	LEXER, DUROTIP Präparierscheren	383, 386
		Hohlmeißel	233
L		NOIR Feine Präparierscheren	379
		Osteotome	233
LA FORCE, Adenotome	147	Präparierscheren	420
Adenotomklingen	147	LEXER-MINI, Hohlmeißel	232
LA GRANGE, Feine Scheren	405	Osteotome	232
LABORDE, Trachealdilatatoren	274	LICHTENBERG, DUROGRIP Nadelhalter	510
LACK, Zungenspatel	117	Lichtleiter	58, 152
Lagerungsracks	45	Lichtleiteradapter	58
LAHEY, Organ- und Gewebefasszangen	133	Ligaturinstrumente	142
Präparier- und Ligaturklemmen	490	Ligaturklemmen	475, 477, 484-490
Wundhaken	332	Atraumatische-	465
LAHEY (SWEET), Präparier- und Ligaturklemmen	490	Ligaturscheren	424
LAMBOTTE, Osteotome	228, 230	DUROTIP	390
Lampen, Ersatz-	6	LISTER, Sinusklemmen	343
LANDOLT, E nukleationsscheren	413	Verband- und Kleiderscheren	425, 426
Präpariersauger	104, 541	LISTON, Knochensplitterzangen	249
Raspatorien	211	LITTLER, Feine Präparierscheren	412
Skalpellgriff	369	LOCKLIN, Feine Scheren	405
Spreizzangen	81	LOCKWOOD, Organ- und Gewebefasszangen	496
Tumorfasszangen	85	Löffel, Antrum-	77
LANDOLT-REULEN, TREND Dissektoren	87, 88	Scharfe-	40, 41, 216-222
TREND Häkchen	87, 88	Scharfe-, ERGOPLANT	218
LANE, Chirurgische Pinzetten	453	Stirnhöhlen-	77
LANGE, Fistelhaken	307	Zerumen-	8, 10
LANGENBECK, Drahtbiegezangen	267	Löffelzängchen	21, 22, 24
DUROGRIP Nadelhalter	509	Mikro-Larynx-	154-156
Elevatoren	201	LOPEZ-REINKE, Tonsillendisektoren	541
Knochenhalte zangen	252	LORNA, Tuchklemmen	353
Ohrschlingen	10	LOWER, Präparier- und Ligaturklemmen	490
Raspatorien	213, 214	LUBET, Nasentamponzangen	92
Rippenraspatorien	214	LUC, Septumzangen	71
Wundhaken	326	LUCAE, Ohrhebel	12
LANGENBECK-GREEN, Wundhaken	305	Paracentesenadeln	9
LANGENBECK-MANNERFELT MODIF., Wundhaken mit		Pinzetten, bajonettförmig	442
Treangle-Griff	303	Stimmgabeln	7
Lappenmesser, Mikro-	32	LUCAS, ERGOPLANT Scharfe Löffel	218
Laryngofissurscheren	161	Flachmeißel	227
Laryngoskope, Operations-	151	Hohlmeißel	227
Laryngoskophalter	151	Scharfe Löffel	219
Larynx-Fasszängchen, Mikro-	153, 156	LUER, Hohlmeißelzangen	244, 245
Larynx-Löffelzängchen, Mikro-	154-156	Wundhaken	314
Larynx-Scherchen, Mikro-	155	LUER-FRIEDMANN, ERGOPLANT Hohlmeißelzangen	244
Larynx-Zängchen, Mikro-	155	Hohlmeißelzangen	243
		Luftduschen	8
		Lupusspatel	98

	Seite		Seite
M			
MAC DONALD , Raspatorien	100	Messer, Faden-, Carbon Steel	367
MAGAURAN , Mundsperrerhalter	132	Faden-, Stainless Steel	367
MAGILL , Kathetereinführungszangen	355	Furunkel-	9
Saugkanülen	538	Knorpelritz-	97
MAIER , Korn- und Tupferzangen	346	Konisation-	366
MALTZ , Knochenraspeln	240	Lappen, Mikro	32
MANNERFELT MODIF. , Flachmeißel	223	Mikro-	31-35, 158
Gabelhaken mit Treangle-Griff	301	Mukosa-	96
Osteotome	223	Plastik-	97, 98
Raspatorien	207	Ring-	144-146
Sattelhaken mit Treangle-Griff	304	Rund-, Mikro	33-35
Wundhaken mit Treangle-Griff	301, 303	Schäl-	158
MARBURG MODELL , Flachzangen	267	Schwing-	96
MARQUARDT , Hohlmeißelzangen	247	Septum-	98
MARTINI , Scharfe Löffel	216	Sichel-	9, 77, 158
MASING , DUROGRIP Nadelhalter	501	Teller-	369
Elevatorien	99	Tonsillen-	138
Knorpelritzmesser	97	Messinstrumente	39
Osteotome	105	Messschieber	356
Raspatorien	99	METZENBAUM , DUROTIP Präparierscheren	385, 388, 389
Wund- und Venenhaken	309	Feine Präparierscheren	398
Maßbänder	356	NOIR Feine Präparierscheren	377, 378
MATHIEU , DUROGRIP Nadelhalter	510	NOIR Präparierscheren	376-378
Wundhaken	320	Präparierscheren	422
MAYFIELD , Hohlmeißelzangen	247	Supercut Präparierscheren	395
MAYO , Chirurgische Scheren	418	MEYERDING , Wundhaken	306
DUROTIP Präparierscheren	382, 386	MICRO-ADSON , Feine anatomische Pinzetten	429
NOIR Präparierscheren	378	Feine chirurgische Pinzetten	445, 446
Präparierscheren	418, 419, 421	Präparier- und Ligaturklemmen	484
Supercut Präparierscheren	394	TITANIUM Feine anatomische Pinzetten	428
MAYO-LEXER , DUROTIP Präparierscheren	383, 387	TITANIUM Feine chirurgische Pinzetten	428
NOIR Präparierscheren	379	MICRO-ADSON-BIEMER , Feine chirurgische Pinzetten	445
Präparierscheren	420	MICRO-HALSTED , Arterienklemmen	470
MAYO-STILLE , Chirurgische Scheren	418	MIDDELDORPF , Wundhaken	334
Präparierscheren	418, 419	Mikro-Approximatoren	194
MC CLURE , Mikro-Federscheren	168	Mikrochirurgische Skalpellklingen	369
MC INDOE , Feine anatomische Pinzetten	431	Mikro-Crurotomiescheren	15
Feine chirurgische Pinzetten	449	Mikro-Dissektoren	37
Hauthäkchen	295	Mikro-Fadengabel	158
Hohlmeißel	108	Mikro-Fadenscheren	173
Knochensplitterzangen	250	Mikro-Federscheren	168-175
MC IVOR , Zungenspatel	123, 128	Mikro-Fußplattenhäkchen	29
MC KENTY , Raspatorien	208	Mikro-Gefäßdilatatoren	179
MC KISSOCK , Raspatorien	214	Mikro-Häkchen	27, 28, 30, 158
MEAD , Hämmer	235	Mikro-Knochenmühle, ERGOPLANT	109
Hohlmeißelzangen	246	Mikro-Knüppf-pinzetten	177, 178
MEHDORN , Anlegepinzetten für Gefäßclips	193	Mikro-Lappenmesser	32
Gefäßclips	192	Mikro-Larynx-Fasszängchen	153, 156
Meißel	233	Mikro-Larynx-Löffelzängchen	154-156
Flach-	42, 108, 223, 225-227, 230, 232	Mikro-Larynx-Scherchen	155
Hohl-	42, 105, 107, 108, 223, 225-227, 231-233	Mikro-Larynx-Zängchen	155
Septum-	105, 107	Mikro-Messer	31, 158
Messer, Diamant-	371	Mikro-Nadelhalter	181-184
Dura-	98	Dia Dust	185-189, 508
		Dia Dust, TITANIUM	166, 167
		DUROGRIP	190, 191

Alphabetischer Index

M – N

	Seite		Seite
Mikro-Nadeln	25	MURPHY , Wundhaken	325
Mikro-Perforatoren	26	MUSEUX , Organ- und Gewebefasszangen	133
Mikro-Pinzetten, Anatomische-, Dia Dust	180	MUSGROVE , Zerumenlöffel	10
Atraumatische-	180	MYLES , Conchotome	70
Chirurgische-, Dia Dust	180	Myringotome	9
Dia Dust	180	Myrtenblattsonden	519
ERGOPLANT	180, 436		
Uhrmacher-Modelle	176		
Mikro-Präparierscheren	171		
Mikro-Raspatorien	36-38	N	
Mikro-Ringpinzetten	180	Nadelhalter, Dia Dust, Mikro-	185-189, 508
Mikro-Rundmesser	33-35	Dia Dust, Mikro-, TITANIUM	166, 167
Mikro-Schaber	30	DUROGRIP	266, 500-510
Mikro-Schälmesser	158	DUROGRIP , Mikro-	190, 191
Mikro-Scheren	14, 15, 65, 83, 84, 169	Kehlkopf-	157
Mikro-Sichelmesser	158	Mikro-	181-184
Mikro-Skalpelle	362	Mikro-, Dia Dust	185-189, 508
Mikro-Venenscheren	170	Mikro-, Dia Dust, TITANIUM	166, 167
Mikro-Zange	83	Mikro-, DUROGRIP	190, 191
MIKULICZ , Arterienklemmen	483	mit Schere, DUROGRIP	504
Organ- und Gewebefasszangen	491	TITANIUM	166, 167, 508
Tonsillenklemmen	483	Nadeln, Führungs-	525
MILLER , ERGOPLANT Knochenfeilen	241	Mikro-	25
Fasszängchen	16	Unterbindungs-	158, 511-513
Knochenraspeln	241	Paracentese-	9
Scharfe Löffel	216	Nagelhautscheren	400
MILLES , Mikro-Federscheren	171	NAGER , Tonsillenfasszangen	138
MINOP TREND , Adapter	63	Nahtpinzetten, DUROGRIP	441
Optiken	64	Nasenflügelretractoren	102
Siebtray	63	Nasenflügelscheren	413
Spül-, Sauggriff	63	Nasenfrakturaufrichter	111
Spül-, Saugschäfte	64	Nasenhaken	103
Spül-, Saugschläuche	63	Nasennebenhöhlen-Stanzen	66
MIXTER , Präparier- und Ligaturklemmen	490	Nasenuliven	8
MIXTER-O'SHAUGNESSY , Präparier- und Ligaturklemmen	488	Nasenplastikschere	413
Mobilisatoren, Stapes-	31	Nasenpolypenschnürer	112
MODELL PICCOLO , Watteträger	522	Nasenrachenzangen	148
MOLLISON , Tonsillendissektoren	137	Nasenretractor	103
Wundspreizer	284	Nasensägen	99
MOLT , Mundsperrerr	119	Nasensaugrohr	537
Raspatorien	205	Nasenscheren	65, 90, 91
MORITZ-SCHMIDT , Zungendrücker	116	Nasensonden	521
MORSE , Nervpräparierschere	406	Nasenspekula	50-59
MOYNIHAN , Arterienklemmen	473	Nasenspiegel	96
MÜHLING , Knochenscheren	249	Nasentamponzangen	92, 93
Raspatorien	211	Nasenzangen	73, 94
Mukosamesser	96	Feine-	73
MÜLLER , Atraumatische Gefäßclips	458	NEGUS , Arterienklemmen	483
Fadenklemmen	458	Bruststütze	132
Gefäßclips	458	Fadengabeln	142
Haut- und Wundhäkchen	295	Ringmesser	145
Mikro-Federscheren	172	Saugdissektoren	104
Mikro-Nadelhalter	184	Tonsillenklemmen	483
Mundkeile, Silikon-, ERGOPLANT	120	NELATON , Hohlsonden	518
Mundsperrerr	119, 121-124	NELSON-METZENBAUM , DUROTIP Präparierscheren	389
Mundsperrerrhalter	132		

	Seite		Seite	
Nerv-Approximator	195	P		
Ersatznadeln	195			
Nervhäkchen	12, 290-293		PAPAVERO , Spreizinstrument	82
Nerv-Präparierscheren	399, 415		PAPAVERO-CASPAR , Hypophysenspekula	82
NICOLA , Mikro-Schere	83		Paracentesenadeln	9
Mikro-Zange	83		PARKER , Wundhaken	314, 316
TREND Küretten	86, 88		Parotishaken	308
NISSEN , Arterienklemmen	475		PARTSCH MOD. LANGE , Raspatorien	208
Präparier- und Ligaturklemmen	475		PARTSCH , Flachmeißel	226
NOIR , Feine Fadenscheren	375		Hohlmeißel	226
Feine Präparierscheren	375-379		Raspatorien	208
Knochenstanzen	260, 261		PASSOW , Stößel	238
Präparierscheren	376-379		PAUL , Sehnenscheidenhaken	308
Scheren mit Wellenschliff	375-379		PAYR , Führungs-Hohlsonden	515
NORTHBENT , Ligaturscheren	424		PEAN , Arterienklemmen	342
NOYES , Mikro-Federscheren	168		Korn- und Tupperzangen	342
Nystagmusbrillen	6		Schlauchklemmen	342, 478
			PEET , Splitterzangen	455
O			PENNINGTON , Organ- und Gewebefasszangen	496
OBWEGESER , Ahlen	239		Raspatorien	99
Meißel	233		PENNYBAKER , Raspatorien	214
Raspatorien	212		Perforatoren, Mikro-	26
Wundhaken	329, 330		Peripheralklemmen, Atraumatische-	467
OBWEGESER-FREER , Elevatorien	203		Peritoneumklemmen	491
OCHSNER , Fadenpinzette	435		PERKINS , Wundspreizer	282
OFFICER , Chirurgische Pinzetten	453		PERWITZSCHKY , Speichelgangschere	404
Ohrhäkchen	12		Pinzetten, Anatomische-	434, 435
Ohrhebel	10, 12		Anatomische-, Dia Dust	180
Ohrküretten	11		Anatomische-, Feine	429-433
Ohrpolypenschnürer	13		Anatomische-, Feine TITANIUM	428, 431
Ohrschlingen	10		Atraumatische-	438, 439
Ohrsonden	8, 521		Atraumatische TITANIUM-	437
Öhrsonden	519		Atraumatische DUROGRIP-	440
Ohrspekula	2-5		Atraumatische ERGOPLANT-	428
Ohrspekulahalter	6		Atraumatische Ultra-Light-	436
Ohrtamponzangen	24		Augen-	445
Öl, STERILIT	234		bajonettförmig	111, 442, 443
OLDBERG , Rongeur	85		bajonettförmig, DUROGRIP	441
Oliven, Nasen-	8		Chirurgische-	447, 450-454
Ölspray, STERILIT	555		Chirurgische-, Dia Dust	180
Operations-Laryngoskope	151	Chirurgische, ERGOPLANT	428	
Optiken	64	Chirurgische-, Feine	445-449	
Organfasszangen	133, 492-497	Chirurgische-, Feine TITANIUM	428, 431	
Atraumatische-	495	Clipanlege-	193, 194, 197	
ORMEROD , Löffelzängchen	22	Dia Dust-	180	
Orthodontische Zangen	267	DUROGRIP-	440, 441	
O'SHAUGNESSY , Präparier- und Ligaturklemmen	488, 489	Faden-	435	
Osteotome	105-107, 223, 225-228, 230-233, 320	Feine-	429-433, 445-449	
Fischschwanz-	106	Feine TITANIUM-	428, 431	
OSTROM , Antrumstanze	66	Fixier-	111	
OVERHOLT , Präparier- und Ligaturklemmen	487	für Weichgewebe, ERGOPLANT	428	
OVERHOLT-GEISSENDOERFER , Präparier- und Ligaturklemmen	486	Gefäß-	454	
OVERHOLT-MIXTER , Präparier- und Ligaturklemmen	486	Hornhaut-	429	
		kniegebogen-	444	
		Knüpf-	177, 178	
		Mikro-	177, 178, 180	

Alphabetischer Index

P – R

	Seite		Seite
Pinzetten, Mikro-, Atraumatische	180	R	
Mikro-, Dia Dust	180	Racks, Lagerungs-	45
Mikro-, Uhrmacher-Modelle	176	RAGNELL , Feine Präparierscheren	399
Naht-, DUROGRIP	441	Wundhaken	315
Ring-	180	RAMPLEY , Tupfer- und Schwammzangen	348
Splitter-	455	RAMSEY , Anatomische Pinzetten	435
Tumor-	454	RANKIN , Arterienklemmen	474
Ultra-Light-, Atraumatische	436	Raspatorien	38, 99-101, 202, 205, 207-215
Plastikmesser	97, 98	ERGOPLANT-	204
Plastikscheren	406	Mikro-	36-38
Platte, Gaumen-	123	Rippen-	214, 215
PLESTER , Antrumhäkchen	30	Saug-	104
Mikro-Fußplattenhäkchen	29	Raspeln, Diamant-	240
Mikro-Lappenmesser	32	Knochen-	240, 241
Mikro-Schaber	30	Knochen-, DUROGRIP	99, 242
Raspatorium	210	REDON , Führungsnadeln	525
Saugkanülen	43, 532	REILL , Drahtschneidezangen	271
Saugkanülenset	43	Mikro-Nadelhalter	182
Wundspreizer	280, 281	Repositionszangen	254
PLESTER-HELMS , Wundspreizer	280	Reiniger für Knochenmühle, ERGOPLANT	109
Plexiglasstäbchen	234	Repositionszangen	254
POLITZER , Furunkelmesser	9	Retraktor, Nasen-	103
Luftduschen	8	Retraktoren, Nasenflügel-	102
Ohrspekula	2	Tonsillen-	136
Paracentesenadeln	9	Zungen-, ERGOPLANT	118
Sichelmesser	9	REYNOLDS , Feine Präparierscheren	416
Polypenschnürer, Nasen-	112	REYNOLDS-JAMESON , Gefäßscheren	399
Ohr-	13	Ringmesser	144-146
Polypenzangen, Kehlkopf-	160	Rippenfasszangen	253
POTTS , Feine Präparierscheren	416	Rippenraspatorien	214, 215
POTTS-SMITH , Gefäßscheren	423	Rippenscheren	251
Präparierklemmen	475, 477, 484-490	RITTER , Stirnhöhlendilator	80
Atraumatische-	465	RNTNE-HOSPITAL , Wundspreizer	282
Präpariersauger	104, 541	ROBERTS , Raspatorien	205
Präparierscheren	412, 418-422	ROBIN , Tuchklemmen	352
DUROTIP	382-389	ROCHESTER-CARMALT , Arterienklemmen	482
Feine-	398, 399, 406, 412-417	ROCHESTER-OCHSNER , Arterienklemmen	480
Feine-, NOIR	375-379	ROCHESTER-PEAN , Arterienklemmen	479
Mikro-	171	ROEDER , Ligaturinstrumente	142
Nerv-	399, 406, 415	Tuchklemmen	351
NOIR-	376-379	Röhrchen, Spül-	79
Supercut-	394-396	Rohrschaftzängchen	153
Präpariertabletts	39	ROLLET , Hauthäkchen	294
Presszangen, Implantat-	39	Rongeurs	72-76, 85
PROVIDENCE-HOSPITAL , Arterienklemmen	471	ROSE , Wundhaken	314
		ROSEN , Mikro-Lappenmesser	32
		Mikro-Nadeln	25
		Ohrspekula	4, 5
		ROSER-KÖNIG , Mundsperrer	121
		ROUX , Wundhaken	317, 319
		ROWBOTHAM , Saugkanülen	538
		Rundfeilen	234
		Rundmesser	33-35
		RUSKIN , Hohlmeißelzangen	247
		RUSKIN-LISTON , Knochensplitterzangen	250
Q			
QUERVAIN , Elevatorien	201		
QUIRE , Fremdkörperinstrumente	13		

	Seite		Seite
RUSS. MODELL , Chirurgische Pinzetten	454	Scheren, Inzisions-	411
RUSSEL-DAVIS , Zungenspatel	125, 126	Iris-	397, 400
RYDEL-SEIFFER , Stimmgabeln	7	Kleider-	425, 426
RYDER , Dia Dust Mikro-Nadelhalter	508	Knochen-	249
DUROGRIP Nadelhalter	506, 507	Knorpel-	417
TITANIUM Nadelhalter	508	Laryngofissur-	161
		Ligatur-	424
		Ligatur-, DUROTIP	390
		Mikro-	14, 15, 65, 83, 84, 168-175
		Nagelhaut-	400
		Nasen-	65, 90, 91
		Nasenflügel-	413
		Nasenplastik-	413
		NOIR-	375-379
		NOIR-, mit Wellenschliff	375-379
		Plastik-	406
		Präparier-	171, 412, 418-422
		Präparier-, DUROTIP	382-389
		Präparier-, Feine	375-399, 406, 412-417
		Präparier-, Nerv	406
		Präparier-, NOIR	375-379
		Präparier-, Supercut	394-396
		Rippen-	251
		Schwestern-	425
		Sehnen-	414
		Septum-	91
		Speichelgang-	404
		Strabismus-	398
		Supercut-	392, 393
		Supercut-, Feine-	392
		Tonsillen-	139
		Venen-	170
		Verband-	425, 426
		Wundrand-	408
		Schieber, Mess-	356
		Schilddrüsenhaken	311
		SCHINK , Handdermatom	113
		Schläuche, Silikon-, Ersatz	119
		Spül-, Saug-, MINOP TREND	63
		Schlauchklemmen	342, 349, 350, 478
		Schleifsteine	234
		Schlingen, Draht-	13, 112, 141
		Ohr-	10
		SCHMIEDEN , Führungs-Hohlsonden	514
		Schneideplatten, ERGOPLANT	109
		Schneidezangen, Draht-	270
		Schnellkupplung, UNITRAC	61
		SCHNIDT , Arterienklemmen	483
		Tonsillenklemmen	483
		Schnürdrähte	141
		Schnürer, Ohrpolypen-	13
		Tonsillen-	140, 142
		Tonsillen-, SUSI	140
		SCHOENBORN , Wund- und Venenhaken	311
		SCHUHKNECHT , Mikro-Rundmesser	35
		Saugkanülen	537

Alphabetischer Index

S

	Seite		Seite
Schwammzangen	348, 497	Skalpellklingen, Stainless Steel	366, 367
SCHWARTZ , Clip-Anlegezangen	198	SLUDDER-BALLENGER , Tonsillotome	143
Gefäßclips	198	Tonsillotomgriff	143
SCHWECKENDICK , Tonsillenscheren	139	Sonden, Augen-	521
SCHWEDISCHES MODELL , Anatomische Pinzetten	435	Doppelknopf-	520
Schwesternscheren	425	Hohl-	514, 515, 518
Schwingmesser	96	Knopf-	520, 521
SEBILEAU , Elevatorien	201	Knopf-, Sinus	520
SEDILLOT , Raspatorien	213	Myrtenblatt-	519
Sehndurchziehsonden	519	Nasen-	521
Sehnenscheidenhaken	308, 309	Ohr-	8, 521
Sehnenscheren	414	Öhr-	519
SEIFFERT , Speichelgangsonden	521	Sehndurchzieh-	519
Seitenschneider	271	Speichelgang-	521
SELDIN , Raspatorien	205	Stirnhöhlen Ostium	80
SELMAN , Chirurgische Pinzetten	454	Spannarm	6
SEMB , Knochenhaltezangen	253	Spannplatte, Dermatome	113
Rippenfasszangen	253	Spatel, Lupus-	98
SEMKEN , Feine anatomische Pinzetten	431	Zungen-	116-118, 123, 125-131, 522
Feine chirurgische Pinzetten	448	Speichelgangsscheren	404
SENN-MILLER , Wundhaken	312	Speichelgangsonden	521
Septum-Hohlmeißel	105, 107	Spekula, Hypophysen-	81, 82
Septummesser	98	Nasen-	50-59
Septumrichtzangen	110	Ohr-	2-5
Septumscheren	91	Septum-	57
Septumspekula	57	SPENCER , Ligaturscheren	424
Septumzangen	71, 95	SPENCER-WELLS , Arterienklemmen	478
Set, Saugkanülen-	43, 528	Sperrer, Carotis-	279
SEWALL , Elevatorien	202	Mund-	119, 121-124
Raspatorien	202	Spiegel, Kehlkopf-	150
SHAMBAUGH , Mikro-Häkchen	27, 28	Nasen-	96
SHEA , Ohrspekula	5	Spiegelgriffe	150
Scharfe Löffel	40	Splitterpinzetten	455
Sichelmesser	9, 77	Splitterzangen	455
Mikro-	158	Spray, Öl-, STERILIT	555
Sicherheitsskalpelle, Einmal-	358, 359	Spreizer, Glomus	286
Siebbeinzangen	72, 74-76	Haut-	285
Siebtray, MINOP TREND-	63	Struma-	287
Silikoneinlage	123	Thyroid-	287
Silikonmundkeile, ERGOPLANT-	120	Wund-	275-285, 289
Silikonschläuche, Ersatz-	119	Spreizinstrument	82
SILVER , Handdermatom	113	Spreizzangen	81
SIMON , Fistelhaken	307	Spritzen	543-545
SIMS-MAIER , Korn- und Tupferzangen	347	Spülgriffe, MINOP TREND-	63
Sinusklemmen	343	Spülkanülen	80, 542
Sinus-Knopfsonden	520	Spülröhrchen	79
Sinuskopie-Trokar	80	Spülschäfte, MINOP TREND-	64
Skalpelle, Mikro-	362	Spülschläuche, MINOP TREND-	63
Einmal-	358-362	ST. BARTS , Ohrhäkchen	12
Mikro-	362	Rongeurs	74, 75
Sicherheits-	358, 359	ST. CLAIR-THOMPSON , Nasenspekula	50
Steril-	360-362	Ringmesser	146
Skalpellgriffe	363-365	ST. MARTIN , Augenpinzetten	445
Mikrochirurgische Klingen	368, 369	Feine chirurgische Pinzetten	445
Skalpellklingen, Carbon Steel	366, 367	Stäbchen, Test	234
Mikrochirurgische-	369	Stabinstrumente, Handgriff für-	159

	Seite		Seite
STACKE , Ohrsonde	521	Tellermesser	369
STAMM , Knochensplitterzangen	248	TESSIER , Osteotome	226
STAMMBERGER , Antrumstanzen	67	Teststäbchen	234
STANDARD , DUROGRIP Pinzetten	441	THOREK , Gefäßscheren	423
Stanzen, Antrum-	66, 67	Thyroid-Spreizer	287
Hammerkopf-	23	TIECK-HALLE , Nasenspekula	52, 57
Haut-	113	TILLEY , Nasentamponzangen	92
Knochen-	255-257, 261-265, 282	Ohrtamponzangen	24
Knochen-, NOIR	260, 261	TILLEY-LICHTWITZ , Antrumtrokare	79
Nasennebenhöhlen-	66	Tissue, forceps	453
Tonsillen-	143	TITANIUM , Anatomische Pinzetten, Feine	428, 431
Stapeselevatoren	36	Atraumatische Pinzetten	437
Stapesmobilisatoren	31	Atraumatische Gefäßklemmen	468, 469
STELLBRINK , Hohlmeißelzangen	243	Chirurgische Pinzetten, Feine	428, 431
Steriler Überzug für den UNITRAC Haltearm	61	Dia Dust, Mikro-Nadelhalter	166, 167
STERILIT , Öl	234	Feine anatomische Pinzetten	428, 431
Ölspray	555	Feine chirurgische Pinzetten	428, 431
Sterilskalpelle	360-362	Nadelhalter	508
STERNBERG , Wundhaken	313	THORPE , Feine anatomische Pinzette	429
STEVENS , Feine Präparierscheren	398, 414	Hornhautpinzette	429
Gefäß- und Sehnenscheren	414	TOBOLD , Zungenspatel	118
Supercut Scheren	392	TÖNNIS , Durahäkchen	294
STIEGLITZ , Splitterzangen	455	Duramesser	98
STILLE , Flachmeißel	230	DUROGRIP Nadelhalter	509
Hohlmeißel	231	Feine Präparierscheren	417
Osteotome	231	TÖNNIS MODIF. , DUROGRIP Nadelhalter	509
Präparierscheren	420	TÖNNIS-ADSON , DUROTIP Präparierscheren	384, 387
STILLE-BARAYA , Gefäß- und Tumorphinzetten	454	Feine Präparierscheren	416
Stimmgabeln	7	NOIR Feine Präparierscheren	377
Stirnhöhlen Ostium Sonden	80	Tonsillendisektoren	136, 137, 541
Stirnhöhlendilatoren	80	Tonsillenfasszangen	134, 135, 138
Stirnhöhlen-Doppelinstrument	80	Tonsillenklemmen	483
Stirnhöhlenlöffel	77	Tonsillennmesser	138
Stößel	238	Tonsillennretraktoren	136
Strabismusscheren	398	Tonsillenscheren	139
STRANDELL-STILLE , Sehnenscheidenhaken	309	Tonsillenschnürer	140, 142
STRASSBURGER MODELL , Chirurgische Pinzetten	454	SUSI	140
Strumaspreizer	287	Tonsillenstanzen	143
STRUYCKEN , Conchotome	70	Tonsillotome	143
Stütze, Brust-	132, 151	Tonsillotomgriff	143
Supercut Scheren	392, 393	TOYNBEE , Ohrspekula	3
Feine Scheren	392	Trachealdilatoren	274
Präparierscheren	394-396	Trachealhäkchen	298-300
SUSI Tonsillenschnürer	140	Träger, Watte-	522-524
SYME , Raspatorien	205	Tränenkanal-Dilatator	521
Tonsillendisektoren	137	Transplantatträger	36
Syndesmotome	202	Trays, Sieb-, MINOP TREND	63
		TRELAT , Raspatorien	209
		TREND , Dissektoren	87, 88
		Enukleatoren	86, 88
		Häkchen	87, 88
		Küretten	86-88
		Trephine, Antrum-	79
		TROELTSCH , Pinzetten, kniegebogen	444
		Trokare, Antrum-	79
		Sinuskopie-	80

T

Tablets, Präparier-	39
TAKAHASHI , Rongeurs	75, 76
Tamponzangen, Nasen-	92, 93
Ohr-	24

Alphabetischer Index

T – Z

	Seite		Seite
Trokare, Universal-	80	WANGENSTEEN, DUROGRIP Pinzetten	441
TROUSSEAU, Trachealdilatatoren	274	WARD, Raspatorien	209
Tubenkatheter	8	Waschzangen	345
Tuchklemmen	351–354	WATSON-CHEYNE, Raspatorien	100
TUDICHUM, Nasenspekula	50	WATSON-WILLIAMS, Rongeure	76
TUFFIER, Organ- und Gewebefasszangen	492	Watteträger	522–524
TUMARKIN, Ohrspekula	4	WAUGH, Feine chirurgische Pinzetten	449
Tumorfasszangen	85	WEBER, Ohrschlingen	10
Tumorzangen	454	WEBSTER, DUROGRIP Nadelhalter	501
Tupferzangen	342–348, 497	WECKER, Augenscheren	169
TYDING, Tonsillenschnürer	142	WEDER, Zungenspatel	117
		WEERDA, Knorpelfasszangen	153
U		WEIL-BLAKESLEY, Rongeure	72
UFFENORDE, Scharfe Löffel	220	WEITLANER, Wundspreizer	277–279
ULRICH-AESCLAP, Korn- und Tupferzangen	345	WEST, Nasentamponzangen	92
Waschzangen	345	WHITE, Tonsillenfasszangen	134
Ultra-Light-Pinzetten, ATRAUMATA	436	WHITEHEAD, Mundsperrer	122
UNITRAC, CO ₂ Druckkartusche	60	WHITEHEAD-JENNINGS, Mundsperrer	122
CO ₂ Kartuschenadapter	60	WIENER MODELL, Nasenspekula	53, 54
Haltearm	60	WIKSTROEM, Präparier- und Ligaturklemmen	488
Haltearm, steriler Überzug	61	WILDE, Nasenpolypenschnürer	112
Schnellkupplung	61	Pinzetten, kniegebogen	444
Universaltrökare	80	WILDER, Tränenkanal-Dilatator	521
Unterbindungsnadeln	158, 511–513	WILLIGER, Elevatorien	200
US-ARMY, Wundhaken	321	Raspatorien	209
		Scharfe Löffel	216, 221
V		Wundhaken	306
VANNAS, Mikro-Federscheren	168, 170, 171	WILSON, Arterienklemmen	483
Venenhäkchen	291	Tonsillenklemmen	483
Venenhaken	309–311	WULLSTEIN, Mikro-Nadel	25
Venenscheren, Mikro-	170	Raspatorien	38
Verbandscheren	425, 426	Wundspreizer	278
Verbindungsklemme, flexibel	60	Wundhäkchen	294–300
VERHOEVEN, Saugkanülen	44, 529	Wundhaken	103, 296, 301–337
VIDAL, Lupusspatel	98	Treangle-Griff	301, 303, 304
WISE, Mikro-Knüpfpinzetten	177	Wundrandscheren	408
VOLKMANN, Knochen- und Wundhaken	322, 323	Wundspreizer	275–285, 289
Scharfe Löffel	221		
Wundhaken	324	Y	
		YANKAUER, Saugkanülen	539
W		YASARGIL, Mikro-Federscheren	171
WAGENER, Ohrhäkchen	12	Mikro-Zange	83
WALSHAM, Septumrichtzangen	110	Rongeure	85
WALTER, Flachmeißel	108	Spannarm	6
Hohlmeißel	231	Tellermesser	369
Osteotome	107	YOUNG, Zungenzangen	117
Wundhaken	103		
		Z	
		Zahnschutz	152
		Zängchen, Fass-	16–20, 69, 84

	Seite		Seite
Zängchen, Fass-, Mikro-Larynx-	156	Zangen, Tumorfass-	85
Löffel-	21, 22, 24	Tupfer-	342-348, 497
Löffel, Mikro-Larynx-	154-156	Wasch-	345
Mikro-Larynx-	155	Zungen-	117, 497
Mikro-Larynx-Fass-	156	ZAUFAL , Ohrhebel	10
Mikro-Larynx-Löffel-	154-156	ZAUFAL-JANSEN , Hohlmeißelzangen	247
Rohrschaft-	153	ZENKER , Wundhaken	337
Zangen, Abnehme-, Bulldogklemmen	459	Zerumenlöffel	8, 10
Anlege-, Bulldogklemmen	459	Zirkel, Hautmess-	96, 356
Atraumatische Gewebefass-	495	ZOELLNER , Ohrspekula	5
Atraumatische Organfass-	495	Saugkanülen	43, 44, 529
Clipanlege-	198	Zugendrücken	116
Drahtbiede-	23, 267	Zungenretractoren, ERGOPLANT	118
Drahtfass-, DUROGRIP	266	Zungenspatel	116-118, 123, 125-131, 522
Drahtschneide-	270, 271	Zungenzangen	117, 497
Drahtschneide-, DUROTIP	270		
Drahtspann-, DUROGRIP	266		
DUROTIP, Drahtschneide-	270		
Fass-	68, 69, 133, 492-497		
Feine Nasen-	73		
Flach-	267		
Gewebefass-	133, 492-497		
Gewebefass-, Atraumatische	495		
Giraffen-	68		
Hohlmeißel-	243-247		
Hohlmeißel-, ERGOPLANT	244		
Implantat-Press-	39		
Kathetereinführungs-	355		
Kehlkopf-	161		
Kehlkopfpolyphen-	160		
Kieferhöhlenfass-	69		
Knochenfixier-	252		
Knochenhalte-	252, 253		
Knochensplitter-	248-250		
Knochensplitter-, ERGOPLANT	248		
Knorpelfass-	153		
Knorpelritz-	111		
Korn-	342-347, 497		
Mikro-	83		
Nasen-	73, 94		
Nasen-, Feine	73		
Nasenrachen-	148		
Nasentampon-	92, 93		
Ohrtampon-	24		
Organfass-	133, 492-497		
Organfass-, Atraumatische	495		
orthodontische	267		
Repositions-	254		
Rippenfass-	253		
Schwamm-	348, 497		
Septum-	71, 95		
Septumricht-	110		
Siebbein-	72, 74-76		
Splitter-	455		
Spreiz-	81		
Tonsillenfass-	134, 135, 138		

Alphabetischer Index

Index Index

- Numerical Index
- Nummernverzeichnis

Numerical Index – Nummerischer Index

55 – BC

Cat. No.	Page	Cat. No.	Page	Cat. No.	Page	Cat. No.	Page
5518016	361	AN908R	349	BB070R	364	BC022R	398
5518032	360	AN909R	349	BB071R	364	BC023R	398
5518040	360	AN910R	349	BB073R	363	BC026R	399
5518059	360	AN911R	350	BB074R	363	BC027R	399
5518067	361	AN912R	350	BB075R	363	BC029R	399
5518075	361	AN913R	350	BB077R	364	BC030R	404
5518083	361			BB078R	364	BC033R	404
5518091	361	BA210	360	BB079R	364	BC034R	404
5518105	360	BA211	360	BB080R	365	BC050R	403
		BA212	360	BB084R	365	BC056R	400
16600487	367	BA215	360	BB085R	365	BC057R	400
16600495	366	BA215-1	360	BB088R	365	BC058R	412
16600509	366	BA215-C	360	BB089R	365	BC060R	400
16600517	366	BA218	360	BB331R	369	BC061R	400
16600525	366	BA219	361	BB332R	369	BC064R	400
16600541	367	BA220	361	BB361R	369	BC065R	400
16600550	367	BA221	361	BB362R	369	BC100R	400
16600568	367	BA222	361	BB363R	369	BC101R	400
16600576	367	BA223	361	BB364R	369	BC106R	401
16600584	367	BA224	361	BB365R	369	BC107R	401
16600592	367	BA311SU	362	BB366R	369	BC110R	401
16615492	366	BA323SU	362	BB367R	369	BC111R	401
16615522	367	BA364	362	BB368R	369	BC112R	401
16616634	367	BA365	362	BB369R	369	BC113R	401
		BA367	362	BB500	367	BC117R	401
AA804R	356	BA642R	98	BB510	366	BC130R	402
AA805R	356	BA706R	113	BB511	366	BC131R	402
AA806R	356	BA708R	113	BB512	366	BC135R	402
AA845R	356	BA709R	113	BB513	366	BC140R	402
AA846R	356	BA715R	113	BB515	366	BC141R	402
AA847R	356	BA716SU	113	BB515-1	366	BC144R	402
		BA810SU	358	BB515-C	366	BC145R	402
AC468R	150	BA811SU	358	BB518	367	BC153R	403
AC469R	150	BA812SU	358	BB519	367	BC154R	405
AC470R	150	BA813SU	358	BB520	367	BC156R	406
AC471R	150	BA815-1SU	358	BB521	367	BC157R	406
AC472R	150	BA815-CSU	358	BB522	367	BC160R	406
AC473R	150	BA815SU	358	BB523	367	BC161R	406
AC474R	150	BA818SU	358	BB524	367	BC162R	412
AC475R	150	BA819SU	359	BB525	367	BC163R	412
AC476R	150	BA820SU	359	BB536	367	BC164R	412
AC477R	150	BA821SU	359	BB540	366	BC165R	412
AC478R	150	BA822SU	359	BB542	366	BC166R	415
AC479R	150	BA823SU	359			BC168R	415
AC480R	150	BA824SU	359	BC004R	397	BC170R	414
AC481R	150	BA825SU	359	BC005R	397	BC171R	414
AC483C	150	BA836SU	359	BC006R	397	BC172R	414
				BC007R	397	BC173R	414
AN379R	355	BB045T	368	BC008R	398	BC175R	415
AN380R	355	BB046R	368	BC009R	398	BC177R	415
AN381R	355	BB048R	368	BC010R	398	BC178R	416
AN705R	117	BB052R	368	BC011R	398	BC180R	416
AN706	117	BB053R	369	BC015R	399	BC181R	416
AN709R	497	BB054R	368	BC017R	399	BC184R	417
AN710R	497	BB063R	364	BC020R	398	BC186R	414
AN711R	497	BB068R	363	BC021R	398	BC187R	414

Numerical Index – Nummerischer Index

BC

Cat. No.	Page	Cat. No.	Page	Cat. No.	Page	Cat. No.	Page
BC188R	417	BC273B	377	BC425R	407	BC630R	416
BC189R	417	BC273R	384	BC426R	407	BC631R	416
BC194R	414	BC273W	387	BC427R	407	BC633R	417
BC195R	414	BC273WB	377	BC428R	407	BC634R	417
BC196R	406	BC274R	385	BC441R	410	BC635R	417
BC210B	375	BC275B	378	BC443R	410	BC636R	423
BC210R	380	BC275R	385	BC444R	410	BC643R	423
BC211B	375	BC275W	388	BC445R	410	BC658R	423
BC211R	380	BC275WB	378	BC464R	411	BC659R	423
BC211W	386	BC276R	385	BC474R	411	BC672R	417
BC211WB	375	BC277R	385	BC496R	408	BC680R	422
BC224R	381	BC277W	388	BC497R	408	BC683R	422
BC228R	381	BC283B	379	BC503R	411	BC801R	424
BC231R	381	BC283R	383	BC504R	411	BC802R	424
BC231W	386	BC283W	386	BC506R	411	BC803R	424
BC234R	381	BC283WB	379	BC544R	418	BC805R	424
BC242R	382	BC284B	379	BC545R	418	BC814R	268
BC243R	382	BC284R	383	BC547R	418	BC815R	268
BC250R	382	BC284W	387	BC554R	418	BC848R	426
BC251R	382	BC284WB	379	BC555R	418	BC849R	426
BC252B	378	BC287W	389	BC557R	418	BC860R	426
BC252R	382	BC294W	390	BC558R	382	BC861R	426
BC253B	378	BC295W	390	BC559R	382	BC862R	426
BC253R	382	BC303R	408	BC562R	419	BC863R	426
BC253W	386	BC304R	408	BC563R	419	BC876R	426
BC253WB	378	BC313R	409	BC564R	419	BC881R	425
BC256R	384	BC314R	409	BC565R	419	BC885R	425
BC257B	375	BC315R	409	BC570R	418	BC890R	425
BC257R	384	BC316R	409	BC572R	418	BC900R	392
BC257W	387	BC317R	409	BC573R	418	BC901R	392
BC257WB	375	BC320R	407	BC575R	418	BC903R	392
BC258R	384	BC321R	407	BC576R	419	BC904R	392
BC259B	376	BC323R	407	BC577R	419	BC905R	392
BC259R	384	BC324R	407	BC578R	419	BC906R	392
BC259W	387	BC325R	407	BC579R	419	BC907R	392
BC259WB	376	BC326R	407	BC580R	420	BC909R	393
BC260R	385	BC327R	407	BC581R	420	BC911R	393
BC261B	376	BC328R	407	BC584R	421	BC915R	393
BC261R	385	BC330R	407	BC585R	421	BC916R	394
BC261W	388	BC341R	410	BC587R	421	BC917R	394
BC261WB	376	BC343R	410	BC588R	421	BC919R	393
BC262R	385	BC344R	410	BC589R	421	BC920R	396
BC263B	377	BC345R	410	BC590R	420	BC921R	396
BC263R	385	BC346R	410	BC591R	420	BC924R	394
BC263W	388	BC374R	411	BC592R	420	BC925R	394
BC263WB	377	BC403R	408	BC597R	423	BC926R	394
BC265B	378	BC404R	408	BC600R	422	BC927R	394
BC265R	385	BC411R	409	BC601R	422	BC930R	395
BC265W	388	BC413R	409	BC602R	422	BC931R	395
BC265WB	378	BC414R	409	BC603R	422	BC933R	396
BC267W	389	BC415R	409	BC604R	422	BC934R	395
BC270R	385	BC416R	409	BC605R	422	BC935R	395
BC271B	377	BC417R	409	BC606R	422	BC936R	395
BC271R	385	BC421R	407	BC607R	422	BC937R	395
BC271W	388	BC423R	407	BC628R	415	BC939R	393
BC271WB	377	BC424R	407	BC629R	416	BC970R	425

Numerical Index – Nummerischer Index

BC – BF

Cat. No.	Page	Cat. No.	Page	Cat. No.	Page	Cat. No.	Page
BC971R	425	BD221T	428	BD510R	445	BD690R	454
BC973R	425	BD222R	429	BD511R	445	BD692R	454
BC975R	425	BD223R	429	BD512R	445	BD700R	447
BC977R	425	BD224R	429	BD513R	446	BD701R	447
BC978R	425	BD225R	429	BD514T	428	BD702R	447
BC979R	425	BD226R	429	BD516T	428	BD725R	454
BC980R	425	BD227T	431	BD520R	446	BD726R	454
BC981R	425	BD228R	431	BD521R	446	BD735R	454
BC983R	425	BD229R	431	BD522R	446	BD736R	454
BC985R	425	BD230R	431	BD523R	446	BD750R	454
BC987R	425	BD231R	433	BD527R	451	BD755R	454
BC988R	425	BD232R	433	BD533R	451	BD760R	454
BC989R	425	BD236R	431	BD535R	451	BD870R	442
		BD238R	432	BD537R	451	BD878R	442
BD023R	434	BD239R	432	BD539R	451	BD879R	442
BD025R	434	BD243R	432	BD540R	451	BD880R	442
BD027R	434	BD246R	432	BD541R	451	BD883R	443
BD029R	434	BD247R	432	BD547R	452	BD885R	443
BD030R	434	BD250R	433	BD549R	452	BD886R	443
BD031R	434	BD257R	433	BD552R	451	BD887R	443
BD035R	435	BD260R	177	BD553R	451	BD888R	443
BD037R	435	BD261R	177	BD555R	451	BD900R	444
BD043R	434	BD264R	177	BD557R	451	BD902R	444
BD045R	434	BD268R	432	BD559R	451	BD903R	444
BD047R	434	BD269R	432	BD560R	451	BD904R	444
BD049R	434	BD301R	430	BD561R	451	BD905R	444
BD050R	434	BD302R	430	BD575R	452	BD910R	444
BD051R	434	BD303R	430	BD577R	452	BD911R	444
BD065R	435	BD304R	430	BD579R	452	BD952R	455
BD067R	435	BD305R	430	BD580R	452	BD963R	455
BD068R	435	BD311R	430	BD581R	452	BD964R	455
BD069R	435	BD312R	430	BD587R	453	BD965R	455
BD077R	435	BD313R	430	BD589R	453	BD980R	455
BD078R	435	BD314R	430	BD591R	453	BD992R	455
BD081R	433	BD315R	430	BD597R	453	BD993R	455
BD083R	435	BD320R	430	BD598R	453	BD995R	455
BD130R	435	BD321R	430	BD600R	452		
BD151R	440	BD329R	176	BD602R	453	BF003R	343
BD154R	440	BD330R	176	BD603R	453	BF004R	343
BD156R	440	BD331R	176	BD604R	453	BF006R	343
BD157R	440	BD333R	176	BD606R	453	BF008R	343
BD160R	441	BD335R	176	BD607R	453	BF010R	343
BD164R	441	BD336R	177	BD651R	450	BF016R	343
BD165R	441	BD337R	177	BD657T	431	BF021R	343
BD168R	441	BD338R	177	BD660R	449	BF027R	344
BD171R	441	BD340R	177	BD661R	449	BF032R	344
BD173R	441	BD343R	176	BD662R	449	BF033R	344
BD180R	441	BD345R	176	BD663R	449	BF040R	344
BD181R	441	BD500R	448	BD665R	448	BF041R	344
BD198R	441	BD501R	448	BD666R	448	BF046R	344
BD210R	430	BD502R	448	BD667R	448	BF047R	344
BD213R	431	BD505R	177	BD668R	448	BF056R	346
BD215R	431	BD506R	446	BD669R	448	BF057R	346
BD216R	431	BD507R	446	BD670R	449	BF058R	346
BD217R	431	BD508R	446	BD671R	449	BF059R	346
BD220R	429	BD509R	445	BD678R	450	BF060R	345

Numerical Index – Nummerischer Index

BF – BJ

Cat. No.	Page	Cat. No.	Page	Cat. No.	Page	Cat. No.	Page
BF061R	345	BH027R	459	BH198R	475	BH619R	480
BF062R	345	BH030R	460	BH199R	475, 485	BH630R	480
BF063R	345	BH031R	460	BH200R	475	BH631R	480
BF065R	345	BH032R	460	BH201R	475	BH642R	481
BF070R	347	BH034R	460	BH202R	475	BH643R	481
BF071R	347	BH100R	470	BH203R	475	BH644R	481
BF076R	347	BH104R	470	BH205R	476	BH645R	481
BF077R	347	BH105R	470	BH206R	477	BH646R	481
BF078R	347	BH106R	471	BH207R	477	BH647R	481
BF112R	348	BH108R	470	BH209R	477, 488	BH648R	481
BF113R	348	BH109R	470	BH210R	476	BH649R	481
BF116R	348	BH110R	470	BH211R	476	BH650R	481
BF118R	348	BH111R	470	BH212R	475	BH651R	481
BF120R	348	BH114R	470	BH213R	475	BH800R	482
BF121R	348	BH115R	470	BH214R	476	BH801R	482
BF122R	348	BH118R	470	BH215R	476	BH804R	482
BF123R	348	BH119R	470	BH216R	477	BH805R	482
BF300R	492	BH120R	470	BH217R	477	BH807R	482
BF301R	492	BH121R	470	BH300R	342	BH808R	482
BF309R	133	BH123R	472	BH302R	342	BH902R	496
BF310R	133	BH124R	473	BH304R	342	BH906R	497
BF311R	133	BH125R	473	BH312R	342	BH908R	497
BF426R	351	BH126R	473	BH316R	342	BH949R	483
BF431R	351	BH127R	473	BH318R	342	BH951R	483
BF432R	351	BH130R	471	BH332R	478	BH952R	483
BF433R	351	BH131R	471	BH333R	478	BH957R	483
BF436R	351	BH134R	471	BH334R	478	BH959R	483
BF437R	351	BH135R	471	BH335R	478	BH961R	483
BF439R	352	BH139R	471	BH336R	478	BH963R	483
BF440R	352	BH140R	472	BH337R	478	BH965R	483
BF442R	352	BH141R	472	BH338R	478		
BF443R	352	BH143R	471	BH339R	478	BJ002R	484
BF444R	351	BH144R	472	BH361R	478	BJ008R	484
BF448R	351	BH145R	472	BH410R	342, 349	BJ009R	484
BF458R	354	BH150R	472	BH412R	478	BJ011R	484
BF459R	354	BH151R	472	BH413R	478	BJ012R	484
BF460R	353	BH154R	472	BH414R	478	BJ013R	485
BF461R	353	BH155R	472	BH415R	478	BJ014R	485
BF463R	353	BH160R	473	BH422R	478	BJ015R	485
BF464R	353	BH161R	473	BH424R	478	BJ016R	485
BF465R	354	BH164R	474	BH425R	478	BJ017R	485
BF466R	354	BH165R	474	BH442R	479	BJ018R	485
		BH166R	474	BH443R	479	BJ019R	486
BH011R	459	BH167R	474	BH444R	479	BJ020R	486
BH012R	459	BH168R	475	BH445R	479	BJ021R	486
BH013R	459	BH170R	473	BH446R	479	BJ022R	486
BH014R	459	BH171R	473	BH447R	479	BJ023R	486
BH015R	459	BH176R	474	BH448R	479	BJ024R	486
BH016R	459	BH177R	474	BH449R	479	BJ025R	486
BH017R	459	BH178R	475	BH450R	479	BJ026R	486
BH018R	459	BH183R	476	BH451R	479	BJ037R	489
BH020R	459	BH187R	476	BH610R	480	BJ038R	489
BH021R	459	BH191R	477	BH612R	480	BJ039R	489
BH022R	459	BH193R	477	BH614R	480	BJ050R	488
BH023R	459	BH196R	477	BH615R	480	BJ051R	488
BH026R	459	BH197R	477	BH618R	480	BJ057R	489

Numerical Index – Nummerischer Index

BJ – BT

Cat. No.	Page	Cat. No.	Page	Cat. No.	Page	Cat. No.	Page
BJ060R	490	BM057R	507	BM905R	514	BN902R	525
BJ061R	490	BM058R	507	BM911R	515	BN903R	525
BJ067R	488	BM063R	505	BM913R	515	BN904R	525
BJ080R	487	BM064R	505	BM920R	515	BN905R	525
BJ081R	487	BM065R	503	BM922R	515	BN906R	525
BJ082R	487	BM066R	503	BM940	515	BN907R	525
BJ083R	487	BM067R	503			BN912R	525
BJ086R	487	BM074R	506	BN003R	518	BN913R	525
BJ097R	484	BM075R	506	BN004R	518	BN914R	525
BJ098R	484	BM110R	266	BN006R	518	BN915R	525
BJ100R	487	BM111R	266	BN010R	518	BN916R	525
BJ102R	487	BM112R	266	BN012R	518	BN917R	525
BJ103R	487	BM124R	504	BN015R	518	BN922R	525
BJ120R	489	BM127R	504	BN020R	518	BN923R	525
BJ121R	489	BM128R	504	BN034R	519	BN924R	525
BJ122R	489	BM129R	504	BN036R	519	BN925R	525
BJ300R	491	BM132R	510	BN040R	519	BN926R	525
BJ304R	491	BM148R	510	BN054R	519	BN942R	525
BJ305R	491	BM149R	510	BN063R	519	BN943R	525
BJ306R	491	BM150R	510	BN064R	519	BN944R	525
BJ308R	491	BM151R	510	BN066R	519	BN945R	525
		BM153R	510	BN068R	519	BN946R	525
BM001R	190	BM154R	510	BN070R	519	BN947R	525
BM002R	190	BM165R	510	BN090R	520		
BM003R	190	BM183R	509	BN104R	520	BT001R	313
BM004R	191	BM184R	506	BN110	520	BT004R	315
BM005R	191	BM186R	509	BN113R	520	BT005R	312
BM008R	500	BM191R	509	BN114R	520	BT006R	312
BM009R	501	BM193R	509	BN116R	520	BT007R	312
BM010R	500	BM196R	509	BN118R	520	BT008R	312
BM011R	501	BM301R	508	BN120R	520	BT010R	314
BM012R	501	BM302R	508	BN125R	520	BT011R	314
BM013R	502	BM325R	508	BN134R	520	BT012R	315
BM014R	501	BM327R	508	BN136R	520	BT019R	314
BM015R	502	BM385T	508	BN138R	520	BT020R	315
BM016R	502	BM386T	508	BN140R	520	BT021R	315
BM017R	502	BM387T	508	BN150R	520	BT022R	316
BM018R	502	BM560R	181	BN160	521	BT025R	314
BM019R	502	BM562R	181	BN161	521	BT026R	316
BM020R	503	BM563R	183	BN170R	521	BT028R	317
BM022R	503	BM564R	183	BN172R	521	BT029R	317
BM023R	503	BM770R	513	BN175R	80	BT030R	317
BM024R	501	BM771R	513	BN184R	522	BT031R	317
BM025R	505	BM780R	513	BN400R	523	BT032R	317
BM026R	505	BM781R	513	BN403	523	BT033R	317
BM032R	505	BM801R	511	BN404	523	BT034R	319
BM033R	505	BM802R	511	BN440R	523	BT035R	319
BM034R	505	BM806R	512	BN445R	523	BT036R	319
BM035R	505	BM807R	512	BN452R	524	BT040R	320
BM044R	507	BM808R	512	BN457R	524	BT041R	321
BM045R	507	BM809R	512	BN460R	524	BT042R	320
BM046R	507	BM810R	511	BN461R	524	BT047R	321
BM047R	507	BM811R	511	BN465R	524	BT048R	321
BM054R	507	BM900R	514	BN466R	524	BT049R	321
BM055R	507	BM901R	514	BN467R	523	BT075R	291
BM056R	507	BM902R	514	BN468R	524	BT080R	291

Numerical Index – Nummerischer Index

BT – BW

Cat. No.	Page	Cat. No.	Page	Cat. No.	Page	Cat. No.	Page
BT082R	291	BT194R	306	BT356R	327	BV006R	275
BT083R	291	BT195R	306	BT357R	327	BV007R	275
BT084R	293	BT196R	306	BT358R	327	BV028R	276
BT088R	293	BT197R	306	BT359R	327	BV030R	276
BT089R	293	BT198R	306	BT361R	327	BV032R	276
BT090R	293	BT199R	311	BT363R	327	BV033R	276
BT091R	293	BT221R	323	BT364R	327	BV066R	277
BT100R	298	BT222R	323	BT365R	327	BV067R	277
BT103R	298	BT223R	323	BT369R	331	BV068R	279
BT106R	298	BT224R	323	BT370R	331	BV070R	277
BT107R	298	BT225R	323	BT371R	331	BV071R	277
BT111R	299	BT227R	323	BT372R	331	BV072R	279
BT112R	299	BT228R	323	BT373R	331	BV073R	277
BT113R	299	BT229R	323	BT400R	333	BV074R	277
BT114R	299	BT230R	323	BT404R	334	BV075R	279
BT116R	299	BT232R	322	BT405R	334	BV076R	278
BT117R	299	BT234R	322	BT406R	334	BV077R	278
BT118R	299	BT238R	322	BT408R	334	BV078R	281
BT119R	299	BT239R	322	BT457R	310	BV079R	281
BT120R	296	BT240R	322	BT458R	310	BV084R	282
BT121R	300	BT241R	322	BT459R	337	BV085R	282
BT122R	300	BT242R	324	BT464R	335	BV086R	287
BT123R	300	BT243R	324	BT465R	336	BV087R	287
BT124R	300	BT244R	324	BT594R	337	BV088R	284
BT126R	300	BT246R	324	BT595R	337	BV090R	280
BT127R	300	BT248R	324	BT901R	301	BV091R	280
BT128R	300	BT252R	324	BT902R	301	BV092R	284
BT129R	300	BT253R	324	BT904R	301	BV093R	284
BT132R	299	BT254R	324	BT906R	301	BV094R	282
BT133R	299	BT256R	324	BT911R	301	BV097R	279
BT134R	299	BT257R	324	BT912R	301	BV101R	278
BT136R	299	BT258R	324	BT913R	301	BV104R	278
BT137R	299	BT259R	324	BT916R	301	BV105R	280
BT138R	299	BT260R	324	BT917R	301	BV106R	280
BT161R	307	BT261R	324	BT918R	301	BV243R	283
BT166R	307	BT265R	324	BT921R	301	BV427R	286
BT167R	307	BT293R	325	BT922R	301	BV428R	286
BT169R	308	BT294R	325	BT923R	301	BV432R	286
BT170R	308	BT295R	325	BT926R	301	BV433R	286
BT171R	308	BT296R	325	BT927R	301	BV434R	286
BT172R	308	BT311R	326	BT928R	301	BV996R	285
BT173R	305	BT315R	326	BT933R	303	BV997R	285
BT174R	305	BT316R	326	BT940R	303	BV998R	285
BT177R	305	BT320R	326	BT943R	303	BV999R	285
BT178R	305	BT321R	326	BT944R	303	BW080R	289
BT179R	305	BT322R	326	BT945R	303	BW081R	289
BT180R	309	BT323R	326	BT946R	303	BW085R	289
BT181R	309	BT325R	326	BT948R	304	BW086R	289
BT182R	310	BT326R	326	BT949R	304	BW087R	289
BT183R	310	BT327R	328	BT951R	304	BW088R	289
BT184R	311	BT328R	328	BT958R	304	BW090R	289
BT185R	311	BT340R	328			BW091R	289
BT187R	311	BT351R	332	BV001R	275	BW092R	289
BT190R	310	BT352R	332	BV002R	275	BW093R	289
BT192R	311	BT353R	332	BV003R	275	BW094R	289
BT193R	306	BT354R	327	BV005R	275		

Numerical Index – Nummerischer Index

DB – FA

Cat. No.	Page	Cat. No.	Page	Cat. No.	Page	Cat. No.	Page
DB086	234	DO548R	205	DP552R	268	EA095R	495
DB090	234	DO552R	205	DP560R	269	EA096R	495
DB091	234	DO553R	205	DP561R	269		
DB095	234	DO605R	216	DP563R	269	EB001R	490
DB096	234	DO606R	216	DP569R	269	EB003R	490
DB097	234	DO608R	219				
DB098	234	DO609R	219	DX050R	428	EJ126R	80
		DO611R	208	DX051R	428	EJ305R	80
DF112R	236	DO612R	208	DX052R	428	EJ315R	79
DF114R	237	DO642R	208	DX055R	428	EJ316R	79
DF771R	531	DO650R	218	DX105R	118	EJ317R	79
DF773R	531	DO651R	218	DX113	120	EJ318R	79
DF774R	531	DO655R	218	DX114	120		
DF775R	531	DO656R	218	DX115	120	EO164R	133
DF781R	531	DO670R	218	DX120R	120		
DF783R	531	DO671R	219	DX203R	204	FA001R	275
DF784R	531	DO672R	219	DX220R	218	FA005R	274
DF785R	531	DO673R	219	DX252R	241	FA006R	274
		DO674R	219	DX253R	241	FA007R	274
DO208R	380	DO704R	105, 224	DX303R	180, 436	FA025R	298
DO209R	380	DO706R	105, 224	DX305R	368	FA026R	298
DO210R	401	DO711R	227	DX500R	244	FA030R	88
DO211R	401	DO713R	227	DX501R	248	FA031R	88
DO218R	403	DO715R	227	DX545202	236	FA032R	88
DO219R	405	DO717R	227	DX545R	236	FA033R	88
DO250R	380	DO722R	230	DX601R	252	FA034R	88
DO251R	405	DO723R	230	DX801R	109	FA035R	88
DO404R	306	DO732R	230	DX802R	109	FA036R	88
DO432R	335	DO733R	230	DX803R	109	FA037R	88
DO438R	336	DO750R	232	DX810R	109	FA038R	88
DO439R	336	DO751R	232	DX811R	109	FA039R	88
DO440R	333	DO752R	232			FA040R	88
DO441R	333	DO753R	232	EA010R	492	FA041R	86
DO450R	329	DO754R	232	EA012R	492	FA042R	86
DO451R	329	DO755R	232	EA013R	493	FA043R	86
DO452R	329	DO771R	241	EA014R	493	FA044R	86
DO453R	329	DO772R	241	EA015R	493	FA045R	86
DO454R	329	DO773R	241	EA016R	493	FA046R	86
DO455R	329	DO810R	239	EA017R	493	FA047R	86
DO460R	330	DO811R	239	EA020R	494	FA060R	86
DO461R	330	DO812R	239	EA025R	494	FA061R	87
DO462R	330	DO813R	239	EA026R	494	FA062R	87
DO463R	330	DO814R	239	EA030R	494	FA063R	87
DO464R	330			EA031R	494	FA064R	87
DO465R	330	DP011R	267	EA032R	494	FA065R	87
DO501R	202	DP031R	267	EA033R	494	FA066R	87
DO502R	202	DP035R	267	EA036R	496	FA067R	87
DO503R	202	DP121R	267	EA037R	496	FA068R	87
DO504R	202	DP122R	267	EA039R	496	FA069R	84
DO510R	209	DP501R	270	EA040R	496	FA070R	84
DO518R	212	DP505R	270	EA041R	496	FA071R	84
DO520R	205	DP520R	271	EA042R	496	FA072R	84
DO523R	211	DP530R	270	EA050R	495	FA073R	84
DO543R	205	DP540R	270	EA052R	495	FA074R	84
DO546R	209	DP541R	270	EA061R	495	FA075R	84
DO547R	205	DP551R	268	EA092R	495		

Numerical Index – Nummerischer Index

FB – FF

Cat. No.	Page	Cat. No.	Page	Cat. No.	Page	Cat. No.	Page
FB130R	179	FB553R	466	FD220R	83	FD615R	194
FB328R	460	FB554R	466	FD222R	83	FD622R	198
FB329R	460	FB559R	464	FD224R	83	FD623R	198
FB330R	460	FB560R	464	FD226R	83	FD624R	198
FB331R	460	FB561R	464	FD228R	65, 83	FD628R	198
FB362R	461	FB563R	464	FD230R	181	FD635R	195
FB363R	461	FB570R	464	FD231R	181	FD636R	195
FB364R	461	FB784R	439	FD232R	181	FD870R	196
FB365R	461	FB785R	439	FD233R	181	FD871R	196
FB366R	461	FB870R	251	FD240R	182	FD872R	196
FB367R	461	FB873R	251	FD241R	182	FD873R	196
FB369R	461	FB881R	251	FD242R	182	FD874R	196
FB382R	463	FB882R	251	FD243R	182	FD875R	196
FB383R	463	FB890R	251	FD244R	182	FD876R	196
FB384R	463	FB934R	494	FD245R	182	FD877R	196
FB385R	463	FB938R	493	FD246R	182	FD878R	196
FB387T	437			FD247R	182	FD879R	196
FB388T	437	FC330T	468	FD251R	173	FD880R	196
FB390T	437	FC331T	468	FD252R	173	FD881R	196
FB391T	437	FC337T	469	FD253R	180	FD882R	196
FB394R	438	FC338T	469	FD255R	180	FD883R	196
FB395R	438	FC339T	469	FD256R	180	FD884R	196
FB400R	438	FC340T	469	FD258R	185	FD885R	196
FB401R	439	FC341T	469	FD259R	185	FD886R	196
FB402R	438	FC342T	469	FD280R	178	FD887R	196
FB403R	439	FC343T	469	FD281R	178	FD888R	196
FB406R	439	FC411R	436	FD284R	178	FD889R	196
FB411R	438	FC412R	436	FD285R	178	FD890R	196
FB412R	438			FD286R	178	FD891R	196
FB414R	438	FD011R	170	FD287R	178	FD892R	196
FB415R	438	FD012R	170	FD375R	297	FD893R	196
FB420R	462	FD013R	170	FD376R	297	FD894R	196
FB421R	462	FD014R	170	FD392R	297	FD895R	196
FB422R	462	FD015R	170	FD394R	292	FD896R	197
FB423R	462	FD016R	170	FD395R	292	FD897R	197
FB424R	462	FD017R	170	FD396R	292		
FB425R	462	FD018R	171	FD397R	292	FE005K	458
FB426R	462	FD019R	171	FD398R	292	FE010K	458
FB427R	462	FD020R	171	FD399R	292	FE011K	458
FB432R	462	FD021R	171	FD552R	192	FE012K	458
FB433R	462	FD022R	171	FD554R	192	FE013K	458
FB434R	462	FD023R	171	FD556R	192	FE014K	458
FB435R	462	FD028R	170	FD558R	192	FE020K	458
FB436R	462	FD045R	183	FD560R	192	FE021K	458
FB437R	462	FD046R	183	FD561R	192	FE022K	458
FB452R	466	FD048R	183	FD562R	192	FE023K	458
FB453R	466	FD076R	183	FD568R	193	FE024K	458
FB455R	466	FD079R	183	FD569R	193		
FB463R	467	FD080R	183	FD571R	194	FF168R	62
FB464R	467	FD081R	183	FD572R	194	FF266R	6
FB466R	467	FD100R	171	FD575R	195	FF270R	6
FB467R	467	FD101R	171	FD578R	193	FF275R	6
FB468R	467	FD103R	171	FD611R	194	FF280R	62
FB484R	465	FD113D	371	FD612R	194	FF313R	294
FB498R	465	FD115D	371	FD613R	194	FF321R	294
FB552R	466	FD116D	371	FD614R	194	FF322R	294

Numerical Index – Nummerischer Index

FF – FK

Cat. No.	Page	Cat. No.	Page	Cat. No.	Page	Cat. No.	Page
FF345R	85	FF725R	265	FK302R	210	FK635R	221
FF357R	63	FF726R	264	FK303R	209	FK636R	221
FF589R	82	FF727R	264	FK306R	212	FK637R	221
FF590R	82	FF728R	264	FK307R	212	FK638R	221
FF591R	82	FF729R	264	FK308R	212	FK639R	221
FF595R	82	FF737R	264	FK309R	212	FK650R	77
FF599R	85	FF738R	264	FK310R	209	FK651R	77
FF600R	85	FF739R	264	FK314R	211	FK652R	77
FF605R	85	FF741R	265	FK318R	210	FK653R	77
FF638R	264	FF742R	265	FK319R	210	FK654R	77
FF639R	264	FF743R	265	FK321R	210	FK658R	221
FF645R	264	FF745R	264	FK328R	211	FK659R	221
FF646R	264	FF746R	264	FK329R	211	FK660R	220
FF647R	264	FF747R	264	FK340R	213	FK661R	220
FF648R	264	FF748R	264	FK341R	213	FK662R	222
FF649R	264	FF749R	264	FK344R	213	FK663R	222
FF657R	264	FF750R	265	FK345R	213	FK664R	222
FF658R	264	FF751R	264	FK350R	213	FK665R	222
FF659R	264	FF752R	265	FK360R	214	FK675R	221
FF660R	264	FF753R	264	FK361R	214	FK676R	221
FF661R	264	FF754R	265	FK362R	210	FK677R	221
FF662R	264	FF755R	265	FK378R	214	FK678R	221
FF663R	264	FF769R	264	FK379R	214	FK679R	221
FF664R	264	FF770R	264	FK390R	214	FK684R	222
FF665R	264	FF771R	264	FK391R	214	FK685R	222
FF666R	264	FF772R	264	FK394R	211	FK686R	222
FF667R	264	FF773R	264	FK400R	215	FK800R	216
FF668R	264	FF781R	265	FK401R	215	FK801R	216
FF669R	264	FF782R	265	FK402R	215	FK803R	216
FF677R	264	FF783R	265	FK403R	215	FK813R	216
FF678R	264	FF784R	265	FK530R	207	FK814R	216
FF679R	264	FF785R	265	FK532R	207	FK817R	216
FF680R	264	FF913R	238	FK534R	207	FK850R	216
FF681R	264	FF914R	238	FK541R	207	FK900B	260
FF682R	264	FF915R	238	FK542R	207	FK900R	262
FF683R	264			FK543R	207	FK901B	260
FF684R	264	FH605SU	63	FK552R	207	FK901R	262
FF685R	264	FH610R	64	FK611R	220	FK902B	260
FF692R	265	FH611R	64	FK612R	220	FK902R	262
FF693R	265	FH615	63	FK613R	220	FK903B	260
FF694R	265			FK614R	220	FK903R	262
FF695R	265	FK110R	200	FK615R	220	FK904B	260
FF711R	265	FK120R	200	FK616R	220	FK904R	262
FF712R	265	FK121R	200	FK617R	220	FK905B	260
FF713R	265	FK124R	201	FK621R	220	FK905R	262
FF714R	265	FK130R	201	FK622R	220	FK906B	260
FF715R	264	FK131R	201	FK623R	220	FK906R	262
FF716R	265	FK133R	201	FK624R	220	FK907B	260
FF717R	264	FK139R	201	FK625R	220	FK907R	262
FF718R	265	FK141R	200	FK626R	220	FK908B	260
FF719R	265	FK291R	100, 206	FK627R	220	FK908R	262
FF720R	264	FK292R	100, 206	FK630R	221	FK909B	260
FF721R	265	FK293R	100, 206	FK631R	221	FK909R	262
FF722R	264	FK299R	208	FK632R	221	FK910B	260
FF723R	265	FK300R	209	FK633R	221	FK910R	262
FF724R	264	FK301R	210	FK634R	221	FK911B	260

Numerical Index – Nummerischer Index

FK – FL

Cat. No.	Page	Cat. No.	Page	Cat. No.	Page	Cat. No.	Page
FK911R	262	FK952R	263	FL035R	235	FL225R	226
FK912B	260	FK953B	261	FL036R	235	FL226R	226
FK912R	262	FK953R	263	FL037	235	FL227R	226
FK913B	260	FK955R	263	FL038R	235	FL343R	227
FK913R	262	FK956R	263	FL039R	236	FL345R	227
FK914B	260	FK957R	263	FL044R	237	FL347R	227
FK914R	262	FK958R	263	FL045R	237	FL380R	232
FK915B	260	FK959R	263	FL047	237	FL381R	232
FK915R	262	FK961B	260	FL088R	228	FL382R	232
FK916B	260	FK961R	262	FL089R	228	FL383R	232
FK916R	262	FK962B	260	FL093R	238	FL384R	232
FK917B	260	FK962R	262	FL094R	238	FL390R	232
FK917R	262	FK963B	260	FL095R	238	FL391R	232
FK919R	262	FK963R	262	FL096R	238	FL392R	232
FK920R	262	FK964B	260	FL097R	238	FL393R	232
FK921R	262	FK964R	262	FL098R	238	FL394R	232
FK922R	262	FK965B	260	FL101R	228	FL401R	233
FK923B	260	FK965R	262	FL102R	228	FL402R	233
FK923R	262	FK966B	260	FL104R	228	FL403R	233
FK924B	260	FK966R	262	FL106R	228	FL405R	233
FK924R	262	FK967B	260	FL108R	228	FL406R	233
FK925B	260	FK967R	262	FL109R	228	FL407R	233
FK925R	262	FK968B	260	FL110R	225	FL408R	233
FK926B	260	FK968R	262	FL112R	225	FL411R	233
FK926R	262	FK969B	260	FL114R	225	FL412R	233
FK927B	260	FK969R	262	FL116R	225	FL413R	233
FK927R	262	FK970B	260	FL118R	225	FL415R	233
FK928B	260	FK970R	262	FL120R	225	FL416R	233
FK928R	262	FK971B	260	FL122R	225	FL417R	233
FK930R	263	FK971R	262	FL124R	225	FL418R	233
FK931R	263	FK972B	260	FL126R	225	FL503R	230
FK932R	263	FK972R	262	FL128R	225	FL504R	230
FK933R	263	FK973B	260	FL130R	225	FL505R	230
FK934R	263	FK973R	262	FL132R	225	FL506R	230
FK936R	263	FK974B	260	FL134R	225	FL507R	230
FK937R	263	FK974R	262	FL136R	225	FL512R	231
FK938R	263	FK975B	260	FL138R	225	FL513R	231
FK939R	263	FK975R	262	FL144R	223	FL514R	231
FK940R	263	FK976B	260	FL146R	223	FL515R	231
FK941B	260	FK976R	262	FL148R	223	FL516R	231
FK941R	262	FK977B	260	FL153R	223	FL517R	231
FK942B	260	FK977R	262	FL173R	226	FL523R	231
FK942R	262	FK978B	260	FL174R	226	FL524R	231
FK943R	263	FK978R	262	FL175R	226	FL525R	231
FK944R	263	FK979B	260	FL176R	226	FL526R	231
FK945R	263	FK979R	262	FL183R	226	FL527R	231
FK946R	263	FK982B	260	FL184R	226	FL553R	231
FK948B	261	FK982R	262	FL185R	226	FL554R	231
FK948R	263	FK983B	260	FL186R	226	FL555R	231
FK949B	261	FK983R	262	FL187R	226	FL556R	231
FK949R	263	FK984B	260	FL213R	226	FL557R	231
FK950B	261	FK984R	262	FL214R	226	FL573R	231
FK950R	263	FK985B	260	FL215R	226	FL574R	231
FK951B	261	FK985R	262	FL216R	226	FL575R	231
FK951R	263			FL223R	226	FL576R	231
FK952B	261	FL034	235	FL224R	226	FL577R	231

Numerical Index – Nummerischer Index

FL – GF

Cat. No.	Page	Cat. No.	Page	Cat. No.	Page	Cat. No.	Page
FL583R	231	FM438R	174	FO136R	253	GB600870	555
FL585R	231	FM439R	174	FO216R	249		
FL650R	230	FM440R	174	FO399R	243	GF350R	532
FL651R	230	FM441R	174	FO400R	243	GF351R	532
FL652R	230	FM442R	174	FO406R	243	GF352R	532
FL653R	230	FM444R	174	FO407R	243	GF353R	532
FL654R	230	FM481R	175	FO408R	243	GF354R	532
FL655R	230	FM482R	175	FO409R	243	GF355R	532
FL656R	230	FM483R	175	FO410R	244	GF360R	532
FL658R	230	FM484R	175	FO411R	244	GF361R	532
FL659R	230	FM485R	175	FO412R	245	GF362R	532
FL660R	230	FM486R	175	FO413R	244	GF363R	532
FL661R	230	FM488R	175	FO415R	245	GF364R	532
FL662R	230	FM503R	175	FO416R	245	GF365R	532
		FM504R	175	FO428R	245	GF370R	532
FM010R	172	FM505R	175	FO430R	245	GF371R	532
FM011R	172	FM506R	175	FO432R	245	GF372R	532
FM012R	172	FM507R	175	FO440R	246	GF373R	532
FM013R	172	FM508R	175	FO442R	246	GF374R	532
FM014R	172	FM520R	186, 187	FO450R	246	GF375R	532
FM021R	184	FM521R	186, 187	FO451R	246	GF380R	532
FM040R	172	FM522R	186, 187	FO453R	246	GF381R	532
FM041R	172	FM523R	186, 187	FO455R	246	GF382R	532
FM042R	173	FM524R	186, 187	FO457R	245	GF383R	532
FM043R	173	FM525R	186, 187	FO500R	247	GF384R	532
FM047R	180	FM526R	186, 187	FO502R	247	GF385R	532
FM061R	184	FM527R	186, 187	FO511R	247	GF390R	533
FM218R	186, 187	FM528R	186, 187	FO514R	247	GF391R	533
FM221R	186, 187	FM529R	186, 187	FO515R	247	GF392R	533
FM228R	186, 187	FM530R	186, 187	FO518R	247	GF393R	533
FM232T	167	FM531R	186, 187	FO520R	247	GF394R	533
FM233T	167	FM540R	188, 189	FO599R	243	GF395R	533
FM236R	185	FM541R	188, 189	FO601R	248	GF396R	533
FM238T	167	FM542R	188, 189	FO602R	248	GF397R	533
FM239T	167	FM543R	188, 189	FO604R	248	GF398R	533
FM252T	167	FM545R	188, 189	FO610R	250	GF399R	533
FM253T	167	FM546R	188, 189	FO611R	250	GF401R	533
FM258T	167	FM547R	188, 189	FO612R	250	GF402R	533
FM259T	167	FM548R	188, 189	FO614R	250	GF403R	533
FM276R	185	FM563R	186, 187	FO620R	249	GF404R	533
FM317T	166	FM564R	186, 187	FO622R	249	GF405R	533
FM318T	166	FM565R	186, 187	FO624R	249	GF406R	533
FM327T	166	FM566R	186, 187	FO626R	249	GF407R	533
FM328T	166			FO632R	249	GF408R	533
FM337T	166	FO110R	253	FO634R	249	GF409R	533
FM338T	166	FO111R	253	FO636R	249	GF411R	533
FM388R	191	FO113R	254	FO640R	250	GF412R	533
FM390R	191	FO115R	254	FO641R	250	GF413R	533
FM430R	174	FO116R	254			GF414R	533
FM431R	174	FO117R	254	GA059	555	GF415R	533
FM432R	174	FO118R	254			GF416R	533
FM433R	174	FO119R	254	GB600	555	GF417R	533
FM434R	174	FO120R	252	GB600810	555	GF418R	533
FM435R	174	FO127R	252	GB600820	555	GF419R	533
FM436R	174	FO130R	252	GB600830	555	GF421R	533
FM437R	174	FO135R	253	GB600840	555	GF422R	533

Numerical Index – Nummerischer Index

GF – OF

Cat. No.	Page	Cat. No.	Page	Cat. No.	Page	Cat. No.	Page
GF423R	533	GF944R	539	OA335R	294	OF033N	7
GF424R	533	GF946R	539	OA336R	294	OF043	5
GF425R	533	GF947R	538	OA337R	294	OF044	5
GF426R	533	GF980R	104, 541	OA338R	294	OF045	5
GF427R	533			OA340R	308	OF046	5
GF428R	533	JG598	234, 555	OA351R	296	OF047	5
GF429R	533	JG600	555	OA357R	290	OF080	6
GF470R	534	JG901	61	OA358R	290	OF081	6
GF471R	534			OA359R	290	OF093	4
GF472R	534	LX150R	271			OF094	4
GF473R	534	LX158R	271	OB510	521	OF095	4
GF474R	534	LX159R	271	OB511	521	OF096	4
GF475R	534	LX176R	266	OB512	521	OF097	4
GF476R	534			OB513	521	OF101C	2
GF477R	534	MB229R	471	OB514	521	OF102C	2
GF478R	534	MB279R	213	OB792R	96, 356	OF103C	2
GF479R	534	MB285R	460	OB793R	356	OF104C	2
GF480R	534	MB291R	447			OF108C	2
GF481R	534	MB454R	447	OC020R	429	OF111C	2
GF756R	537	MB603R	519	OC021R	429	OF112C	2
GF757R	537	MB741R	460	OC022R	429	OF113C	2
GF763R	44, 529	MB785R	332	OC024R	448	OF114C	2
GF764R	44, 529			OC025R	448	OF115C	2
GF765R	44, 529	MD124R	536	OC026R	448	OF116C	2
GF766R	44, 529	MD125R	536	OC051R	445	OF117C	2
GF767R	529	MD127R	536	OC069R	429	OF120C	2
GF768R	44, 530	MD129R	536	OC091R	445	OF121C	2
GF770R	44, 530	MD130R	536	OC094R	445	OF122C	2
GF771R	44, 529	MD452R	350	OC100R	447	OF123C	2
GF772R	43, 44, 529	MD453R	350	OC415R	412	OF124C	2
GF773R	43, 44, 529	MD454R	350	OC430R	413	OF125C	3
GF774R	43, 529	MD463	450	OC461R	169	OF126C	3
GF775R	44, 529	MD464	474	OC480R	168	OF127C	3
GF906R	538	MD465R	474	OC482R	168	OF128C	3
GF907R	538	MD466R	474	OC485R	168	OF136	4
GF908R	538	MD467R	474	OC486R	168	OF137	4
GF909R	538	MD468	474	OC491R	169	OF138	4
GF910R	542	MD469	474	OC492R	169	OF139	4
GF911R	542	MD497	321	OC496R	169	OF150	5
GF912R	542	MD568	492	OC497R	169	OF151	5
GF913R	542	MD569	485	OC498R	168	OF152	5
GF917R	531	MD570R	485	OC500R	168	OF153	5
GF918R	531	MD581	296			OF154	5
GF919R	537	MD617	246	OF001N	7	OF155	5
GF923R	535	MD652	350	OF002N	7	OF158	3
GF925R	535	MD653	350	OF003N	7	OF159	3
GF932R	536	MD654	350	OF004N	7	OF161	3
GF933R	535			OF005N	7	OF162	3
GF935R	537	OA310R	309	OF006N	7	OF163	3
GF936R	537	OA311R	309	OF010N	7	OF164	3
GF937R	536	OA312R	309	OF015N	7	OF171	5
GF938R	536	OA313R	309	OF016N	7	OF172	5
GF939R	532	OA314R	309	OF017N	7	OF173	5
GF940R	532	OA332R	294	OF018N	7	OF174	5
GF941R	532	OA333R	294	OF019N	7	OF175	5
GF942R	532	OA334R	294	OF031N	7	OF176	5

Numerical Index – Nummerischer Index

OF – OG

Cat. No.	Page	Cat. No.	Page	Cat. No.	Page	Cat. No.	Page
OF190	8	OF359R	11	OG038R	30	OG162R	38
OF191N	8	OF360R	8	OG040R	31	OG163R	38
OF195N	8	OF361R	10	OG042R	31	OG164R	208
OF196N	8	OF403R	24	OG048R	36	OG165R	208
OF197N	8	OF405R	24	OG050R	36	OG178R	40, 217
OF250C	8	OF407R	24	OG051R	36	OG179R	40, 217
OF251C	8	OF408R	92	OG053R	37	OG180R	40, 217
OF252C	8	OF410R	18	OG054R	37	OG181R	41, 217
OF253C	8	OF411R	18	OG055R	37	OG182R	41, 217
OF254C	8	OF414R	18	OG056R	37	OG184R	41, 217
OF257R	522	OF420R	18	OG060R	37	OG185R	41, 217
OF259R	522	OF423R	22	OG061R	37	OG186R	40, 217
OF261R	522	OF424R	22	OG066R	39	OG189R	41, 217
OF262R	522	OF425R	22	OG070R	26	OG201R	42
OF266R	8	OF431R	24	OG071R	26	OG202R	42
OF267R	8	OF438R	21	OG072R	26	OG203R	42
OF270R	10	OF439R	21	OG073R	26	OG205R	42
OF271R	10	OF440R	21	OG074R	26	OG206R	42
OF272R	10	OF442R	21	OG075R	26	OG207R	42
OF274R	10	OF444R	21	OG080R	28	OG209R	42
OF276R	12, 291	OF448R	22	OG081R	28	OG300R	23
OF277R	12, 291	OF505R	13	OG082R	28	OG301R	23
OF278R	12, 291	OF528R	13	OG083R	28	OG320R	45
OF279R	12, 291	OF600R	9	OG084R	27	OG325R	16
OF282R	12, 290	OF601R	77, 138	OG085R	27	OG329R	18
OF283R	12, 290	OF608R	9	OG086R	27	OG330R	16
OF284R	12, 290	OF610R	9	OG099R	38	OG331R	17
OF285R	12, 290	OF614R	9	OG100R	31	OG332R	17
OF288R	12, 290	OF615R	9	OG101R	31	OG334R	18
OF289R	10	OF618R	9	OG104R	31	OG335R	16
OF290	4	OF626R	9	OG105R	32	OG338R	17
OF291	4	OF760R	255	OG106R	32	OG339R	17
OF292	4	OF768R	255	OG107R	32	OG341R	19
OF293	4			OG108R	32	OG342R	20
OF294	4	OG001R	25	OG109R	32	OG343R	20
OF295	4	OG002R	25	OG110R	34	OG344R	20
OF296	4	OG003R	25	OG112R	34	OG345R	19
OF297	4	OG005R	25	OG116R	35	OG346R	19
OF298	4	OG006R	25	OG123R	35	OG348R	19
OF300R	13	OG007R	27	OG124R	35	OG350R	14
OF303R	13	OG008R	27	OG125R	33	OG351R	14
OF313R	3	OG009R	27	OG126R	33	OG352R	14
OF314R	3	OG010R	27	OG127R	33	OG353R	14
OF315R	3	OG011R	28	OG128R	33	OG354R	15
OF316R	3	OG012R	28	OG129R	33	OG355R	14
OF317R	3	OG013R	28	OG131R	34	OG356R	15
OF320R	10	OG014R	28	OG132R	34	OG357R	15
OF350R	11	OG015R	29	OG133R	34	OG359R	23
OF351R	11	OG016R	29	OG136R	35	OG360R	23
OF352R	11	OG021R	29	OG140R	39	OG950R	43, 528
OF353R	11	OG023R	30	OG141R	39	OG951R	43, 528
OF354R	11	OG031R	30	OG145R	39	OG969R	43, 528
OF355R	11	OG034R	30	OG150R	45	OG970R	43, 528
OF356R	11	OG035R	29	OG151R	45	OG971R	43, 528
OF357R	11	OG036R	30	OG160R	38	OG973R	43, 528
OF358R	11	OG037R	30	OG161R	38	OG974R	43, 528

Numerical Index – Nummerischer Index

OG – OL

Cat. No.	Page	Cat. No.	Page	Cat. No.	Page	Cat. No.	Page
OG982R.....	43, 528	OK163R.....	50	OK529R.....	76	OK812R.....	78
OG983R.....	43, 528	OK164R.....	50	OK530R.....	76	OK813R.....	78
OG984R.....	43, 528	OK165R.....	50	OK531R.....	76	OK814R.....	78
		OK166R.....	50	OK536R.....	74	OK815R.....	78
OK001.....	96	OK167R.....	50	OK537R.....	74	OK816R.....	78
OK030R.....	54	OK225R.....	92	OK538R.....	75	OK874C.....	79
OK035R.....	57	OK226R.....	92	OK544R.....	73	OK875C.....	79
OK036R.....	57	OK242R.....	93	OK545R.....	73	OK876R.....	79
OK037R.....	51	OK243R.....	93	OK546R.....	73	OK877R.....	79
OK038R.....	51	OK245R.....	93	OK547R.....	73	OK900.....	80
OK039R.....	51	OK260R.....	112	OK560R.....	65	OK921R.....	80
OK041R.....	53	OK261R.....	112	OK561R.....	65	OK922R.....	80
OK042R.....	53	OK262R.....	112	OK562R.....	65	OK924R.....	80
OK043R.....	53	OK263R.....	112	OK580R.....	67	OK926R.....	80
OK047R.....	51	OK270R.....	112	OK581R.....	67		
OK048R.....	51	OK293R.....	112	OK582R.....	67	OL010R.....	111
OK049R.....	51	OK350R.....	90	OK583R.....	67	OL011R.....	111, 442
OK051R.....	52	OK351R.....	90	OK584R.....	67	OL102R.....	97
OK052R.....	52	OK352R.....	90	OK600R.....	70	OL104R.....	97
OK053R.....	52	OK353R.....	91	OK602R.....	66	OL107R.....	97
OK058R.....	52	OK365R.....	413	OK603R.....	66	OL109R.....	98
OK060R.....	53	OK366R.....	414	OK606R.....	66	OL111R.....	98
OK061R.....	53	OK367R.....	413	OK607R.....	66	OL112R.....	98
OK062R.....	54	OK368R.....	413	OK608R.....	66	OL113R.....	98
OK070R.....	50	OK369R.....	413	OK609R.....	66	OL114R.....	97
OK071R.....	50	OK370R.....	91	OK612R.....	70	OL120R.....	96
OK072R.....	50	OK371R.....	91	OK613R.....	70	OL140R.....	212
OK073R.....	50	OK372R.....	413	OK620R.....	68	OL141R.....	212
OK076R.....	59	OK373R.....	413	OK621R.....	68	OL142R.....	212
OK077R.....	59	OK374R.....	412	OK622R.....	68	OL143R.....	212
OK078R.....	59	OK378R.....	248	OK641R.....	70	OL151R.....	99, 203
OK081R.....	55	OK400R.....	94	OK642R.....	70	OL152R.....	99, 203
OK082R.....	55	OK405R.....	94	OK643R.....	70	OL153R.....	99, 203
OK083R.....	55	OK410R.....	95	OK644R.....	70	OL154R.....	100, 207
OK084R.....	55	OK412R.....	95	OK646R.....	70	OL155R.....	101, 204
OK085R.....	57	OK422R.....	95	OK647R.....	70	OL157R.....	211
OK090R.....	56, 82	OK433R.....	71	OK680R.....	69	OL159R.....	101, 204
OK091R.....	55	OK434R.....	71	OK681R.....	69	OL160R.....	202
OK092R.....	55	OK435R.....	71	OK682R.....	69	OL161R.....	211
OK093R.....	55	OK436R.....	71	OK683R.....	69	OL162R.....	202
OK094R.....	55	OK440R.....	71	OK684R.....	69	OL163R.....	202
OK099R.....	103	OK441R.....	71	OK690R.....	70	OL164R.....	100, 207
OK100R.....	81	OK442R.....	71	OK704R.....	66	OL165R.....	100, 207
OK101R.....	81	OK443R.....	71	OK711R.....	255	OL166R.....	100, 207
OK102R.....	81	OK503R.....	74	OK712R.....	255	OL168R.....	104, 540
OK103R.....	81	OK505R.....	72	OK737R.....	257	OL169R.....	203
OK105R.....	56	OK506R.....	72	OK740R.....	256	OL170R.....	100, 206
OK106R.....	56	OK507R.....	72	OK741R.....	256	OL171R.....	101, 204
OK107R.....	56	OK508R.....	72	OK742R.....	256	OL177R.....	104, 540
OK108R.....	56, 82	OK509R.....	72	OK745R.....	257	OL179R.....	101, 204
OK115R.....	58	OK520R.....	72	OK794R.....	282	OL180R.....	210
OK116R.....	58	OK521R.....	72	OK795R.....	282	OL187R.....	531
OK117R.....	58	OK522R.....	72	OK800R.....	78, 331	OL192R.....	208
OK118R.....	58	OK525R.....	75	OK804R.....	79	OL195R.....	104, 541
OK161R.....	50	OK526R.....	75	OK805R.....	79	OL196R.....	104, 541
OK162R.....	50	OK527R.....	76	OK811R.....	78	OL198R.....	202

Numerical Index – Nummerischer Index

OL – OM

Cat. No.	Page	Cat. No.	Page	Cat. No.	Page	Cat. No.	Page
OL201R	307	OL346R	227	OL603R	295	OM115R	129
OL202R	102, 302	OL347R	227	OL610R	295	OM116R	124
OL203R	102, 302	OL348R	227	OL611R	296	OM118R	124
OL204R	102, 302	OL349R	227	OL612R	296	OM119R	124
OL206R	297	OL350R	227	OL614R	297	OM150R	131
OL207R	297	OL354R	96	OL615R	295	OM151R	131
OL210R	102, 302	OL355R	96	OL616R	295	OM152R	131
OL211R	309	OL356R	96	OL617R	295	OM153R	131
OL212R	309	OL360R	226	OL619R	295	OM154R	130
OL214R	102, 302	OL361R	226	OL620R	296	OM155R	130
OL218R	103	OL362R	226	OL621R	295	OM156R	130
OL219R	318	OL363R	226	OL622R	296	OM157R	130
OL220R	318	OL366R	226	OL623R	296	OM158R	130
OL221R	320	OL367R	226	OL624R	296	OM169R	123
OL270R	106, 228	OL368R	226	OL626R	295	OM170	123
OL271R	106, 228	OL369R	226	OL627R	295	OM171R	125
OL272R	106, 228	OL370R	226	OL670R	113	OM172R	125
OL273R	106, 228	OL371R	226	OL699R	98	OM173R	125
OL274R	106, 228	OL385R	233			OM174R	125
OL275R	106, 228	OL386R	233	OM030R	119	OM175R	125
OL294R	106, 228	OL387R	233	OM038R	119	OM176R	126
OL296R	106, 228	OL390R	107, 229	OM040R	119	OM177R	126
OL298R	106, 228	OL391R	107, 229	OM041R	119	OM178R	126
OL299R	106, 228	OL392R	107, 229	OM044R	121	OM179R	123
OL300R	106, 228	OL393R	107, 229	OM047R	121	OM181R	127
OL301R	106, 228	OL394R	107, 229	OM048R	121	OM182R	127
OL302R	106, 228	OL401R	240	OM049R	121	OM183R	127
OL303R	106, 228	OL403R	240	OM061R	122	OM185R	132
OL304R	106, 228	OL405R	241	OM062R	122	OM186R	132
OL305R	106, 229	OL406R	241	OM063R	122	OM187R	132
OL307R	106, 229	OL407R	240	OM070R	122	OM202R	116, 522
OL311R	223	OL408R	240	OM071R	122	OM203R	116
OL314R	223	OL409R	240	OM072R	122	OM205R	116
OL316R	223	OL410R	240	OM073R	122	OM208R	116
OL318R	105, 223	OL411R	240	OM078R	150	OM212R	116
OL319R	108, 229	OL412R	240	OM079R	150	OM220R	117
OL320R	108, 229	OL413R	240	OM080R	150	OM221R	117
OL321R	105, 224	OL421R	242	OM081R	150	OM222R	117
OL322R	105, 224	OL423R	242	OM082R	150	OM230R	118
OL323R	105, 224	OL425R	242	OM083R	150	OM235R	118
OL326R	105, 224	OL427R	242	OM084R	150	OM236R	117
OL327R	105, 224	OL429R	242	OM085R	150	OM237R	117
OL328R	105, 224	OL448R	99	OM086R	150	OM251R	313
OL329R	105, 224	OL451R	99	OM087R	150	OM252R	313
OL331R	108, 229	OL452R	99	OM088R	150	OM253R	313
OL332R	108, 229	OL460R	109	OM089R	150	OM307R	200
OL333R	108, 229	OL461R	109	OM090R	150	OM308R	200
OL335R	107, 225	OL470R	110	OM101R	128	OM309R	208
OL336R	107, 225	OL471R	110	OM102R	128	OM311R	209
OL338R	105, 224	OL472R	110	OM103R	128	OM314R	209
OL339R	105, 224	OL473R	110	OM104R	123	OM315R	209
OL341R	225	OL474R	111	OM105R	122	OM391R	147
OL342R	225	OL477R	111	OM111R	129	OM392R	147
OL343R	225	OL479R	111	OM112R	129	OM393R	147
OL344R	227	OL601R	295	OM113R	129	OM396R	147
OL345R	227	OL602R	295	OM114R	129	OM397R	147

Numerical Index – Nummerischer Index

OM – TE

Cat. No.	Page	Cat. No.	Page	Cat. No.	Page	Cat. No.	Page
OM398R	147	OM680R	138	OP313R	155	SL034R	545
OM451R	144	OM681R	138	OP316R	155	SL118R	544
OM452R	144	OM688R	138	OP320R	155	SL122R	544
OM453R	144	OM700R	139	OP325R	155		
OM454R	144	OM707R	139	OP360R	540	SP330	543
OM455R	144	OM710R	139	OP361R	540	SP333	543
OM456R	144	OM711R	139	OP362R	540	SP336	543
OM471R	145	OM750R	141	OP365	543		
OM472R	145	OM751R	141	OP380R	159	TA005771	119
OM473R	145	OM757R	141	OP386R	158	TA009706	119
OM474R	145	OM758R	141	OP387R	158		
OM485R	344	OM760R	140	OP388R	158	TE683R	58
OM486R	521	OM760SU	140	OP389R	158	TE684R	58
OM488	521	OM761R	140	OP390R	158	TE688R	58
OM489R	404	OM768R	140	OP392R	158		
OM490R	148	OM776R	142	OP396R	158		
OM496R	148	OM781R	142	OP401R	153		
OM498R	148	OM801R	143	OP402R	157		
OM499R	148	OM802R	143	OP403R	158		
OM500R	144	OM803R	143	OP405R	158		
OM501R	144	OM806R	143	OP406R	158		
OM502R	144	OM902R	143	OP407R	158		
OM503R	144	OM903R	143	OP408R	158		
OM504R	144	OM915R	142	OP409R	158		
OM505R	144	OM917R	142	OP415R	156		
OM510R	145			OP416R	156		
OM511R	145	OP030R	540	OP417R	156		
OM512R	145	OP031R	540	OP418R	156		
OM513R	145	OP100R	160	OP419R	154		
OM514R	145	OP111R	160	OP906	58		
OM515R	145	OP112R	160	OP913	58, 152		
OM520R	146	OP113R	160	OP914	58		
OM521R	146	OP114R	160	OP923	58		
OM522R	146	OP120R	161				
OM523R	146	OP130R	161, 249	PE487A	64		
OM524R	146	OP280R	151	PE507A	64		
OM602R	133	OP281R	151				
OM611R	134	OP282R	151	RT020R	61		
OM612R	134	OP290R	151	RT040R	60		
OM613R	134	OP292R	151	RT043R	60		
OM616R	135	OP293R	151	RT044SU	60		
OM617R	135	OP294R	151	RT090R	60		
OM618R	135	OP295R	151	RT099R	63		
OM637R	138	OP297R	152				
OM640R	116	OP298R	152	SF811R	543		
OM660R	136	OP299	152	SF812R	543		
OM661R	136	OP300R	153	SF813R	543		
OM663R	137	OP301R	153	SF814R	543		
OM664R	137	OP302R	153				
OM665R	137	OP304R	154	SL002R	544		
OM666R	137	OP305R	154	SL017R	545		
OM668R	136	OP306R	154	SL018R	544		
OM669R	136	OP307R	154	SL022R	544		
OM670R	541	OP310R	155	SL028R	545		
OM671R	539	OP311R	155	SL032R	545		
OM672R	538	OP312R	155	SL033R	545		

Numerical Index – Nummerischer Index

Notice - Notizen

Notice - Notizen

A large, vertically oriented rectangular area with a light gray background and horizontal lines, intended for taking notes. The lines are evenly spaced and run horizontally across the width of the area.

Notice - Notizen

A large gray rectangular area containing numerous horizontal lines for writing notes.

